

System Manual
Non-Contact Safety Switch
HS3A-H21M4 (Multicode)
(Original)

Contents

Correct Use	3
Description of the safety function	5
Exclusion of Liability and Warranty	5
General Safety Instructions	5
Function	7
Changing the approach direction	9
Installation	10
Electrical Connection	12
Notes about UL, c-UL	13
Safety in case of faults	13
Fuse protection for power supply	13
Requirements for connection cables	14
Maximum cable lengths	15
Pin assignment of HS3A	17
Connection of a single HS3A	18
Connection of several HS3A in a switch chain	19
Notes for operation with safe control systems	20
Setup	21
LED displays	21
Functional check	22
System status table	23
Technical data	24
Technical data for HS3A	24
Technical data for actuator HS9Z-ZH31	27
Ordering Information and Accessories	29
Inspection and Service	29
Service	29
Declaration of Conformity	30

Correct Use

The non contact safety switch series **HS3A** are interlocking devices without guard locking (Type 4). HS3A complies with the requirements according to EN IEC 60947-5-3. Devices with unicode evaluation (HS3A-H21U4) possess a high coding level; devices with multicode evaluation (HS3A-H21M4) feature a low coding level.

In combination with a movable safety guard and the machine control, this safety component prevents dangerous machine functions from occurring while the safety guard is open. A stop command is triggered if the safety guard is opened during the dangerous machine function.

This means:

- ▶ Starting commands that cause a dangerous machine function must become active only when the safety guard is closed.
- ▶ Opening the safety guard triggers a stop command.
- ▶ Closing a safety guard must not cause automatic starting of a dangerous machine function. A separate start command must be issued. For exceptions, refer to EN ISO 12100 or relevant C-standards.

Before HS3A is used, a risk assessment must be performed on the machine, e. g., in accordance with:

- ▶ EN ISO 13849-1, Safety of machinery – Safety related parts of control systems – Part 1: General principles for design
- ▶ EN ISO 12100, Safety of machinery – General principles for design – Risk assessment and risk reduction
- ▶ IEC 62061, Safety of machinery – Functional safety of safety-related electrical, electronic and programmable electronic control systems

Correct use includes observing the relevant requirements for installation and operation, particularly based on the following standard:

- ▶ EN ISO 13849-1, Safety of machinery – Safety related parts of control systems – Part 1: General principles for design
- ▶ EN ISO14119, Safety of machinery – Interlocking devices associated with guards – Principles for design and selection
- ▶ EN 60204-1, Safety of machinery – Electrical equipment of machines – Part 1: General requirements

HS3A is only allowed to be operated in conjunction with the intended HS9Z actuators from IDEC and the related connection components from IDEC. On the use of different actuators or other connection components, IDEC provides no warranty for safe function.

Several devices are only allowed to be connected in series using devices intended for series connection with the HS3A. Please check this in the operating instructions of the respective device. A combination of devices from other manufacturers is not allowed.

A maximum of 20 safety switches are allowed to be operated in a switch chain.

Important!

- ▶ The user is responsible for the proper integration of the device into a safe overall system. For this purpose, the overall system must be validated, e.g. in accordance with EN ISO 13849-2.
- ▶ Correct use requires observing the permissible operating parameters (see *Technical data on page 24*).
- ▶ If a product data sheet is included with the product, the information on the data sheet applies in case of discrepancies with the operating instructions.

Description of the safety function

HS3A features the following safety functions:

Monitoring of the safety guard position (interlocking device according to EN ISO 14119)

- ▶ Safety function: The safety outputs are switched off when the safety guard is open (see *Switching states on page 8*).
- ▶ Safety characteristics: category, Performance Level, PFH_D (see *Technical data on page 24*).

Exclusion of liability and warranty

In case of failure to comply with the conditions for correct use stated above, or if the safety instructions are not followed, or if any servicing is not performed as required, liability will be excluded and the warranty void.

General safety instructions

HS3A fulfills personal protection functions. Incorrect installation or tampering can lead to fatal injuries to personnel.

Check the safe function of the safety guard particularly

- ▶ after any setup work
- ▶ after the replacement of a system component
- ▶ after an extended period without use
- ▶ after every fault

Independent of these checks, the safe function of the safety guard should be checked at suitable intervals as part of the maintenance schedule.

Warning!

Danger to life due to improper installation or due to bypassing (tampering).

Safety components fulfill a personal protection function.

- ▶ Safety components must not be bypassed, turned away, removed or otherwise rendered ineffective. On this topic pay attention in particular to the measures for reducing the possibility of bypassing according to EN ISO 14119:2013, section 7.
- ▶ The switching operation must be triggered only by actuators designated for this purpose,
- ▶ Prevent bypassing by means of replacement actuators (only for multicode evaluation). For this purpose, restrict access to actuators and to keys for releases, for example.
- ▶ Mounting, electrical connection and setup only by authorized personnel possessing the following knowledge:
 - specialist knowledge in handling safety components
 - knowledge about the applicable EMC regulations
 - knowledge about the applicable regulations on occupational safety and accident prevention
 - knowledge about HS3A in the operating instructions and the system manual

Important!

Prior to use read the operating instructions and the system manuals, and keep these in a safe place. Ensure the operating instructions and the system manuals are always available during mounting, setup and servicing. IDEC cannot provide any warranty in relation to the readability of the CD-ROM supplied for the storage period required. For this reason you should archive a printed copy of the system manual. You can download these documents from <http://www.idec.com>.

Function

HS3A monitors the position of movable safety guards. The safety outputs are switched on/off when the actuator moves into/out of the operating distance.

HS3A complies with the following safety requirements:

- ▶ Category 4, PL e according to EN ISO 13849-1.
- ▶ Redundant design of the circuit in the unit with self-monitoring.
- ▶ This means that the safety system still functions even if an internal component fails.
- ▶ The switch state of the semiconductor outputs is continuously monitored internally.
- ▶ Short circuit detection at the safety outputs by pulse signals.

HS3A consists of the following components: coded actuator (transponder), and switch.

Whether the complete actuator code of the device is taught in (unicode) or not (multicode) depends on the respective version.

- ▶ **Devices with unicode evaluation (HS3A-H21U4):** The actuator must be assigned to the safety switch by a teach-in operation so that it is detected by the system. This unambiguous assignment ensures a particularly high level of protection against tampering. The system thereby possesses a high coding level.
- ▶ **Devices with multicode evaluation (HS3A-H21M4):** Unlike systems with unique code detection, on multicode devices a specific code is not polled but instead it is only checked whether the actuator is of a type that can be detected by the system (multicode detection). There is no exact comparison of the actuator code with the taught-in code in the safety switch (unique code detection). The system possesses a low coding level.

When the safety guard is closed, the actuator is moved towards the safety switch. When the switch-on distance is reached, power is supplied to the actuator via the switch and data transfer takes place.

If a permissible code is detected, the safety outputs are switched on.

The safety outputs are switched off when the safety guard is opened.

In the event of a fault in the safety switch, the safety outputs are switched off and the DIA LED illuminates red. Occurring faults are detected at the latest on the next demand to close the safety outputs (e.g. on starting).

Door monitoring output

The door monitoring output is switched on as soon as a valid actuator is detected in the operating distance.

Limit-range monitoring

If the safety guard with the actuator should settle over time, the actuator can drift out of the read head operating distance. The device recognizes this situation and indicates that the actuator is in the limit range by flashing the STATE LED. This allows the safety guard to be readjusted in time. Also see *System status table on page 23*.

Highlights

For details for your system and indicators, see the status table on page 23. All safety outputs must be connected to the system and indicators there.

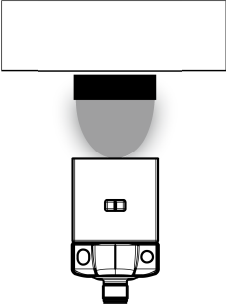
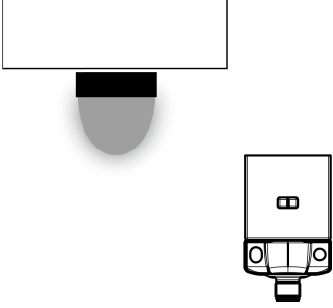
	<p> (reduced detection distance) </p> 	<p> (after opening the door) </p> 
<p> Safety outputs OA and OB </p>	<p>on</p>	<p>off</p>
<p> Monitoring output OUT </p>	<p>on</p>	<p>off</p>

Changing the approach direction

Caution!

Risk of damage to equipment as a result of trapped cables.

- ▶ Make sure that the cables are not trapped or torn off when the approach direction is changed.
- ▶ Make sure that the flat seal is not trapped and that the profile seal is properly positioned in its guide, otherwise the sealing function is no longer ensured.

Procedure of changing the active face

The active face of the HS3A can be adjusted in 5 directions. It is marked by the red face.

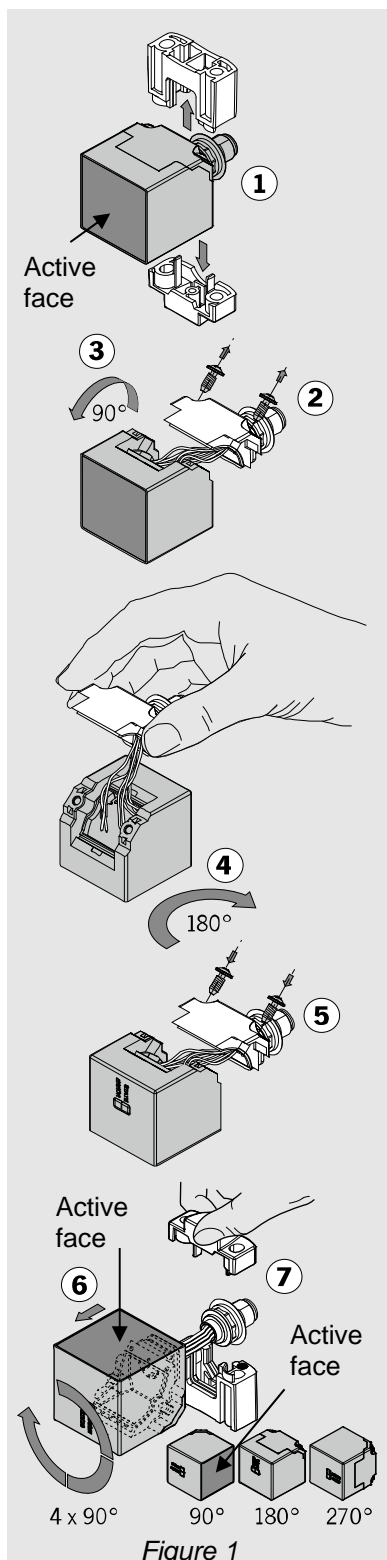

1. Remove the top part of the mounting base and push the bottom part off the mounting base off the HS3A.

2. Unscrew the screws on the fastening bracket.

3. Undo the read head from the fastening bracket and tilt HS3A forward by 90°.

➡ The active face is now pointing downward.

4. Hold the fastening bracket tight and turn HS3A by 180°.

5. Re-tighten the screws for the read head on the fastening bracket. Tightening torque 0.6 N·m.

6. Turn HS3A in 90° steps until the desired approach direction is reached.

7. Push the read head onto the bottom part of the mounting base and re-assemble the mounting base.

Installation

Caution!

Safety switches must not be bypassed, turned away, removed or otherwise rendered ineffective.

- ▶ Observe EN ISO 14119:2013, section 7, for information about reducing the possibilities for bypassing an interlocking device.

Caution!

Risk of damage to device and malfunctions as a result of incorrect installation.

- ▶ HS3A and actuators must not be used as an end stop.
- ▶ Observe EN ISO 14119:2013, sections 5.2 and 5.3, for information about fastening the safety switches and the actuator.

Important!

- ▶ From the assured switch-off distance S_{ar} , the safety outputs are safely shut down. (Refer to page 28.)
- ▶ When mounting several HS3A observe the stipulated minimum distance to avoid mutual interference.

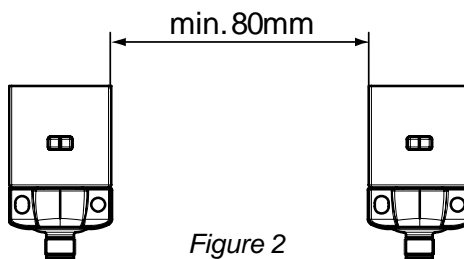

Figure 2

- ▶ If the actuator is installed flush, the switching distance changes as a function of the installation depth and the safety guard material. For this purpose, the operating distance should be checked after installation.

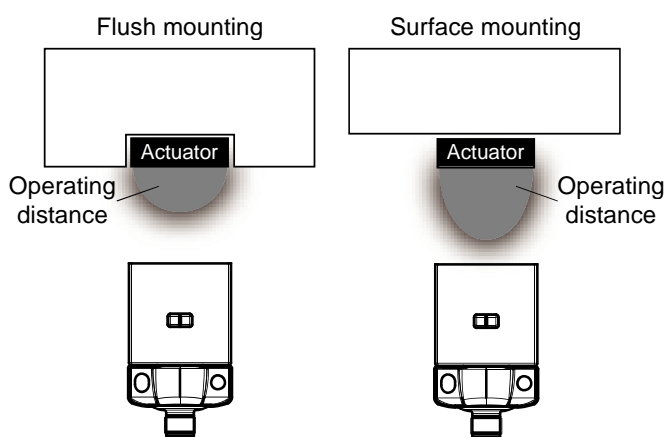

Figure 3

Note the following points:

- ▶ Actuator and HS3A must be easily accessible for inspection and replacement.
- ▶ The switching operation must only be triggered by the specific actuator designated for this purpose.

- ▶ Actuator and HS3A must be fitted so that
 - the front faces are at the minimum switch-on distance $0.8 \times S_{ao}$ or closer when the safety guard is closed (see section *Operating distances and Typical operating distance on page 28*). To avoid entering the area of possible side lobes, a minimum distance is to be maintained in case of a side approach direction. See section *Typical operating distance*.
 - when the safety guard is open up to the distance S_{ar} (assured switch-off distance), a hazard is excluded. (Refer to page 28.)
 - the actuator is positively mounted on the safety guard, e. g. by using the safety screws included.
 - they cannot be removed or tampered with using simple means.
- ▶ Pay attention to the maximum tightening torque for HS3A and actuator mountings of 1N·m.

Electrical Connection

The following connection options are available:

- ▶ Separate operation
- ▶ Series connection with Y-distributors from IDEC
- ▶ Series connection, e.g. with wiring in the control cabinet

Warning!

In case of an error, loss of the safety function through incorrect connection.

- ▶ To ensure safety, both safety outputs (OA and OB) must always be evaluated.
- ▶ Monitoring output (OUT) must not be used as safety outputs.
- ▶ Lay the connection cables with protection to prevent the risk of short circuits.

Caution!

Risk of damage to equipment or malfunctions as a result of incorrect connection.

- ▶ Do not use a control system with pulsing or switch off the pulsing function in your control system. The device generates its own test pulses on the safety outputs. A downstream control system must tolerate these test pulses, which may have a length of up to 1 ms.
The test pulses are also output when the safety outputs are switched off. Depending on the inertia of the connected device (control system, relay, etc.), this can lead to short switching processes.
- ▶ The inputs on an evaluation unit connected must be positive-switching, as the two outputs on the HS3A deliver a level of 24 V DC in the switched-on state.
- ▶ All the electrical connections must either be isolated from the mains supply by a safety transformer according IEC 61558-2-6 with limited output voltage in the event of a fault, or by other equivalent isolation measures (PELV).
- ▶ All electrical outputs must have an adequate protective circuit for inductive loads. The outputs must be protected with a free-wheeling diode for this purpose. RC interface suppression units must not be used.
- ▶ Power devices which are a powerful source of interference must be installed in a separate location away from the input and output circuits for signal processing. The cable routing for safety circuits should be as far away as possible from the cables of the power circuits.
- ▶ In order to avoid EMC interference, the physical environmental and operating conditions at the installation site of the device must comply with the requirements according to the standard EN 60204-1:2006, section 4.4.2 (EMC).
- ▶ Please pay attention to any interference fields in case of devices such as frequency converters or induction heating systems. Observe the EMC instructions in the manuals from the respective manufacturer.

Important!

If the device does not appear to function when operating voltage is applied (e.g. green STATE LED does not flash), HS3A must be returned unopened to the manufacturer.

Notes about UL, c-UL

Important!

- ▶ For use and operation as per the UL, c-UL requirements¹⁾, a power supply with the feature “for use in class 2 circuits” must be used.
Alternative solutions must comply with the following requirements:
 - a) Electrically isolated power supply unit with a max. open-circuit voltage of 30V DC and a limited current of max. 8A.
 - b) Electrically isolated power supply unit in combination with fuse as per UL248. This fuse should be designed for max. 3.3A and should be integrated into the 30V DC voltage section.
- ▶ For use and applications as per the requirements of UL, c-UL¹⁾, a connection cable listed under the UL category code CYJV2 or CYJV must be used.

1) Note on the scope of the UL approval: The devices are tested according to the requirements of UL508 and CSA/ C22.2 No. 14 (protection against electric shock and fire).

Safety in case of faults

- ▶ The operating voltage U_B is reverse polarity protected.
- ▶ The safety outputs are short circuit proof.
- ▶ A short circuit between the safety outputs is detected by the switch.
- ▶ A short circuit in the cable can be excluded by laying the cable with protection.

Fuse protection for power supply

The power supply must be provided with fuse protection depending on the number of switches and current required for the outputs. The following rules apply:

Max. current consumption of an individual switch I_{max}

$$I_{max} = I_{UB} + I_{OUT} + I_{OA+OB}$$

$$I_{UB} = \text{Switch operating current (80 mA)}$$

$$I_{OUT} = \text{Load current of monitoring outputs (max. 200 mA)}$$

$$I_{OA+OB} = \text{Load current of safety outputs OA + OB (2 x max. 400 mA)}$$

Max. current consumption of a switch chain ΣI_{max}

$$\Sigma I_{max} = I_{OA+OB} + n \times (I_{UB} + I_{OUT})$$

$$n = \text{Number of connected switches}$$

Requirements for connection cables

Caution!

Risk of damage to device or malfunctions as a result of incorrect connection cables.

- ▶ Use connection components and connection cables from IDEC
- ▶ On the usage of other connection components, the requirements in the following table apply. IDEC provides no warranty for safe function in case of failure to comply with these requirements.

Observe the following requirements for the connection cables:

Table 1

Parameter	Value	Unit
Conductor cross-section min.	0.34	mm ²
R max.	60	Ω/km
C max.	120	nF/km
L max.	0.65	mH/km
Recommend cable type	LIYY 8x or 5x (for series connection) 0.34mm ²	

Maximum cable lengths

Switch chains are permitted up to a maximum overall cable length of 200 m taking into account the voltage drop as a result of the cable resistance (see table below with example data and case example).

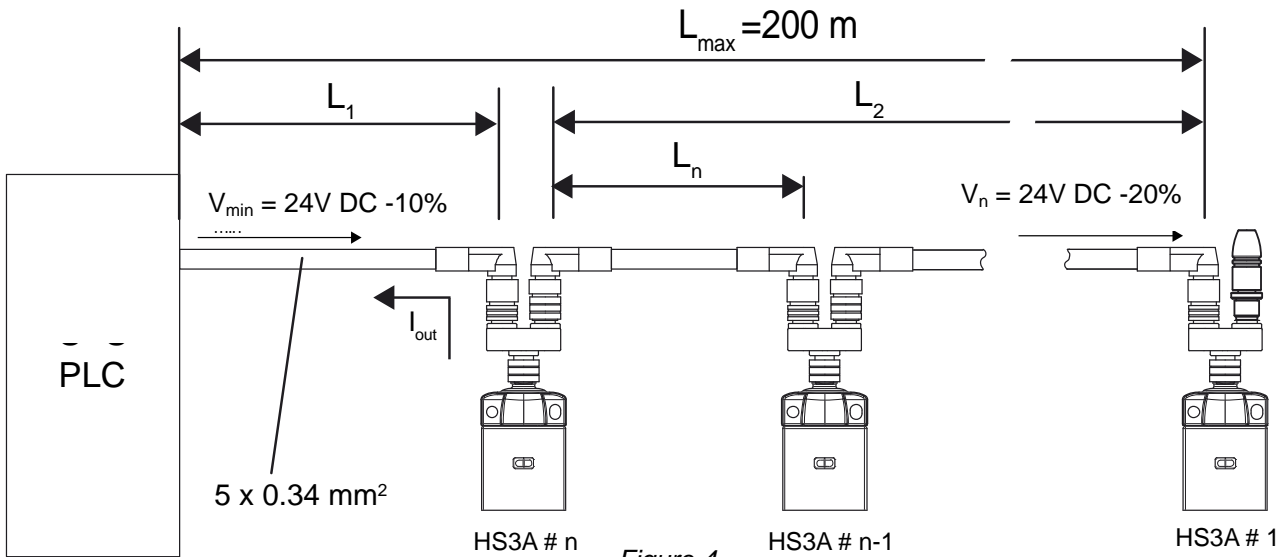

Figure 4

Table 2

n Max. number of Switches for series connection	I_{out} (mA) Possible output current per channel OA/OB	L_1 (m) Max. cable length from the last switch to the control system
5	10	150
	25	100
	50	80
	100	50
	200	25
	300	15
	400	10
6	10	120
	25	90
	50	70
	100	50
	200	25
	300	15
	400	10
10	10	70
	25	60
	50	50
	100	40
	200	25
	300	15
	400	5

Determining cable lengths using the example table (see table 2)

Example: 6 switches are to be used in series. Cabling with a length of 40 m is routed from a safety relay in the control cabinet to the last switch (#6). Cables with a length of 20 m each are connected between the individual HS3A safety switches.

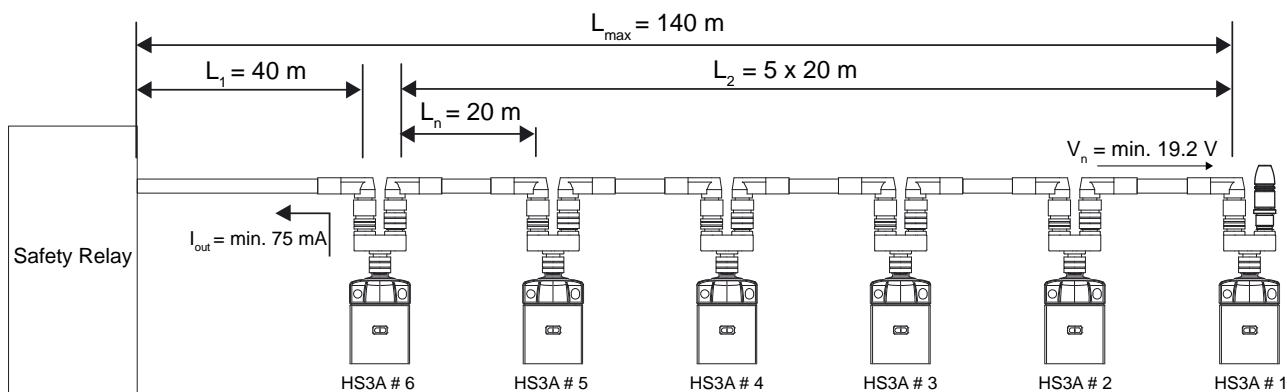

Figure 5: Circuit example with six HS3A

A safety relay is connected downstream which consumes 75 mA on each of the two safety inputs. This operates over the whole temperature range with a voltage of 19.2 V DC (corresponds to 24 V DC -20 %).

All the relevant values can now be determined using the example table:

1. Select the corresponding section in the column n (max. number of switches). Here: 6 switches.
 2. In column I_{OUT} (possible output current per channel OA/OB), find a current greater than or equal to 75 mA. Here: 100 mA.
- ➡ It is then possible to determine the maximum cable length from the last HS3A switch (#6) to the control system from column L1. Here: a length of 50 m is permitted.

Result: The desired cable length L_1 of 40 m is below the permitted value from the table. The overall length of the switch chain L_{max} of 140 m is less than the maximum value of 200 m.

- ➡ The planned application is therefore functional in this form.

Pin assignment of HS3A

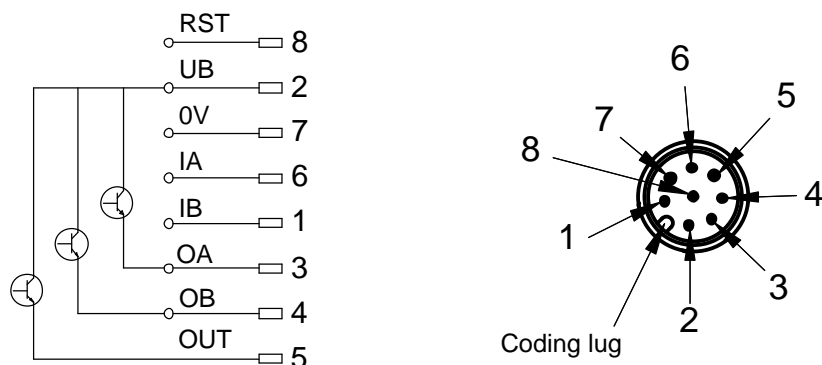

View on the connection side of HS3A

Figure 6: Pin assignment of HS3A

Pin	Designation	Description	Wire color
1	IB	Enable input for channel 2	White
2	UB	Power supply, 24V DC	Brown
3	OA	Safety output, channel 1	Green
4	OB	Safety output, channel 2	Yellow
5	OUT	Monitoring output	Gray
6	IA	Enable input for channel 1	Pink
7	0V	Ground, 0V DC	Blue
8	RST	Reset input	Red

Connection of a single HS3A

If a single HS3A is used, connect the device as shown in Figure 7. The OUT output can be connected routed to a control system as a monitoring output.

The switch can be reset via the RST input. To do this, a voltage of 24 V DC is applied to the RST input for at least 3 seconds. The RST input must be connected to 0 V DC if it is not used.

Important!

The subsystem HS3A complies with PL e in accordance with EN ISO13849-1. To integrate the subsystem in a category 3 or 4 structure, it is necessary to monitor the downstream load (the feedback loop must be monitored).

These examples show only an excerpt that is relevant for connection of the HS3A system. The example illustrated here does not show complete system planning. The user is responsible for safe integration in the overall system.

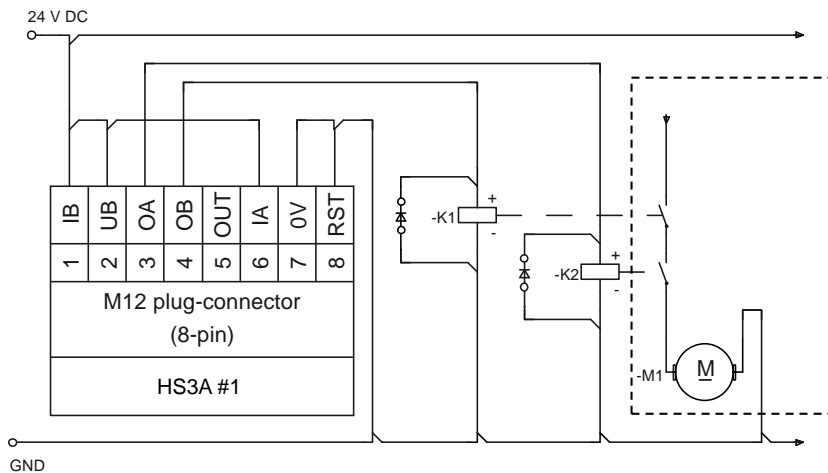

Figure 7: Connection example for a single HS3A

Warning!

In case of an error, loss of the safety function through incorrect connection.

- ▶ To ensure safety, both safety outputs (OA and OB) must always be evaluated. Single-channel use of the safety outputs leads to a loss of the category in accordance with EN ISO 13849-1.

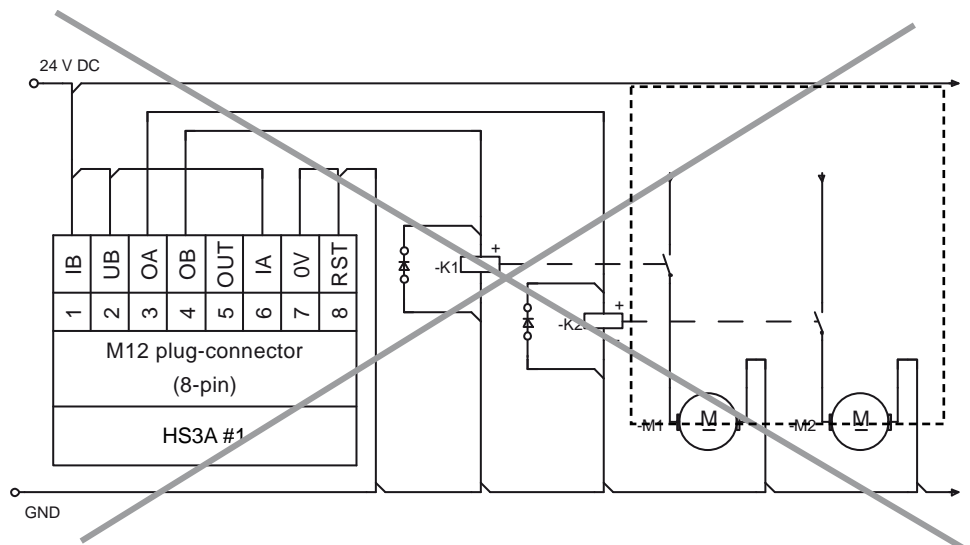

Figure 8: Example of incorrect connection

Connection of several HS3A in a switch chain

Important!

- ▶ A HS3A switch chain may contain a maximum of 20 safety switches.

The switches are connected in series using plug connectors and Y-distributors. If a safety guard is opened or if a fault occurs on one of the switches, the system shuts down the machine. A higher level control system cannot, however, detect which safety guard is open or on which switch a fault has occurred.

The series connection can also be realized via additional terminals in a control cabinet.

The safety outputs are permanently assigned to the respective safety inputs of the downstream switch. OA must be connected to IA and OB to IB. If the connections are interchanged (e.g. OA to IB), the unit will switch to fault state.

Always use input RST in series connections. All switches in a chain can be reset at the same time with this reset input. To do this, a voltage of 24 V DC must be applied to the RST input for at least 3 seconds. If input RST is not used in your application, it must be connected to 0 V DC.

Note the following in this aspect:

- ▶ A common signal must be used for all switches in the chain. This can be a changeover switch or the output of a control system. A button is not suitable because Reset must always be be connected to GND during operation (see switch S1 in Figure 9).
- ▶ Reset must always be performed simultaneously for all switches of the chain.

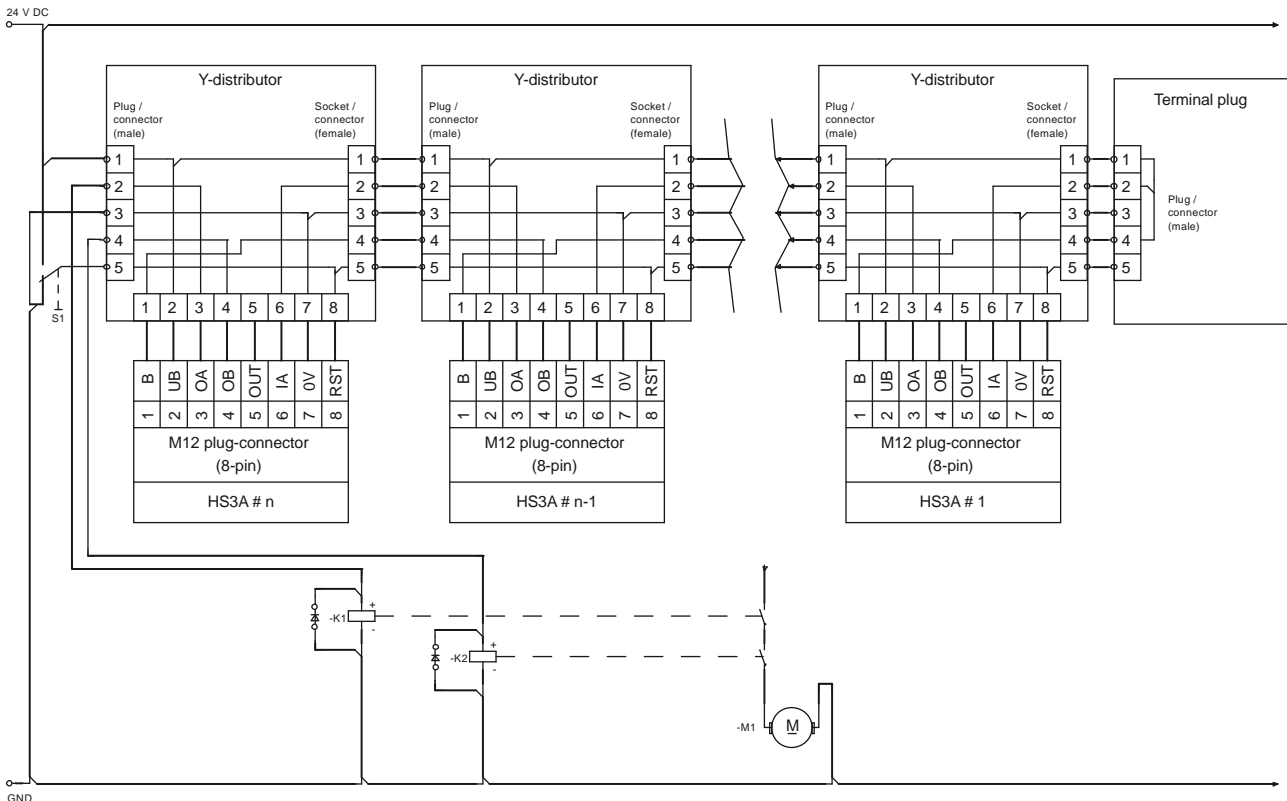

Figure 9: Connection example for series connection

Notes for operation with safe control systems

Important!



Please observe the following requirements for connection to safe control systems:

- ▶ Use a common power supply for the control system and the connected safety switches.
- ▶ A pulsed power supply must not be used for U_B . Tap the supply voltage directly from the power supply unit. If the supply voltage is connected to a terminal of a safe control system, this output must provide sufficient electrical current.
- ▶ Always connect inputs IA and IB directly to a power supply unit or to outputs OA and OB of another HS3A device (series connection). Pulsed signals must not be present at inputs IA and IB.
- ▶ The safety outputs (OA and OB) can be connected to the safe inputs of a control system. Prerequisite: The input must be suitable for pulsed safety signals (OSSD signals, e.g. from light curtains). The control system must tolerate clock pulses on the input signals. This normally can be set up by parameter assignment in the control system. Observe notes of the control system manufacturer. For the pulse duration of your safety switch, please refer to the section *Typical system times on page 25*.

Setup

LED displays

Table 3

LED	Color	State	Significance
STATE	Green	illuminated 	Normal operation
		flashing 	Teach-in operation or power Up Actuator in limit range (refer to System status table on page 23 for further signal functions)
DIA	Red	illuminated 	-Internal electronics fault -Fault at the inputs/outputs

Functional check

After installation and any fault, the safety function must be fully checked.
Proceed as follows:

Warning!

Danger of fatal injury as a result of faults in installation and functional check.

- ▶ Before carrying out the functional check, make sure that there are no persons in the danger area.
- ▶ Observe the valid accident prevention regulations.

1. Switch on operating voltage.

- ▶ The machine must not start automatically.
- ▶ HS3A-H21U4 carries out a self-test.
The green STATE LED flashes for 10 s with 10 Hz.
The green STATE LED then flashes at regular intervals.

2. Close all safety guards.

- ▶ The machine must not start automatically.
- ▶ The green STATE LED illuminates continuously.

3. Enable operation in the control system.













4. Open the safety guard.





- ▶ The machine must switch off and it must not be possible to start it as long as the safety guard is open.
- ▶ The green STATE LED flashes at regular intervals.

Repeat steps 2-4 for each safety guard.

System status table

Table 4

Operating mode	Actuator/ door position	Safety outputs OA and OB	LED indicator output		State
			STATE (green)	DIA (red)	
Self-test	X	off	 10Hz (10s)	○	Self-test after power-up
Normal operation	closed	on		○	Normal operation, door closed
	closed	on	 2Hz	○	Normal operation, door closed, safety outputs switched on, actuator in the limit range → Readjust the door
	closed	off	 1x (in- verse)	○	Normal operation, door closed, preceding device in the switch chain signals "door open" (only with series connection)
	open	off	 1x	○	Normal operation, door open
Fault display	X	off	 2x		Input fault (e.g. missing test pulses, illogical switch state from previous switch in the switch chain)
	closed	off	 3x		Defective actuator (e.g. fault in code or code not readable)
	X	off	 4x		Output fault (e.g. short circuits, loss of switching ability)
	X	off	 5x		Internal fault (e.g. component faulty, data fault) or short circuits of outputs
	X	off	X	X	Internal fault with door fault

Key to symbols	○	LED is not illuminated
		LED is illuminated
	 10Hz(8s)	LED flashes for 10s at 10Hz
	 2Hz	LED flashes at 2Hz
	 nx	LED flashes "n" times, and this is then repeated
	 1x (inverse)	LED flashes (illuminated -> not illuminated -> illu- minated -> not illuminated ->)
	X	Any state

Important!

After the cause has been remedied, faults can generally be reset by opening and closing the door. If the fault is still displayed afterward, use the reset function or briefly interrupt the power supply. Please contact the manufacturer if the fault could not be reset after restarting.

If you cannot find the displayed device status in the System status table, this indicates an internal device fault. In this case, you should contact the manufacturer.

Technical data

Note!

If a product data sheet is included with the product, the information on the data sheet applies in case of discrepancies with the operating instructions.

Technical data for HS3A Table 5

Parameter	Value			Unit
	min.	typ.	max.	
Housing material	PBT			
Weight	0.4			kg
Ambient temperature at $U_B = 24V$ DC	-20	-	+55	°C
Storage temperature	-25	-	+70	
Degree of protection	P67			
Safety class	III			
Degree of contamination	3			
Installation position	Any			
Connection type	M12 plug connector, 8-pin			
Operating voltage U_B (reverse polarity protected, regulated, residual ripple < 5%)	24±15% (PELV)			V DC
For the approval according to UL, c-UL the following applies	Operation only with UL Class 2 power supply, or equivalent measures			
Current consumption	80			mA
Switching load according to UL, c-UL	24V DC, class 2			
External fuse (operating voltage)	0.25	-	8	A
Safety outputs OA/OB	Semiconductor outputs, p-switching, short circuit-proof			
-Output voltage $U(OA)/U(OB)^{1)}$				
HIGH $U(OA)$	$U_B - 1.5$	-	U_B	V DC
HIGH $U(OB)$				
LOW $U(OA)/U(OB)$	0	-	1	
Switching current per safety output	1	-	400	mA
Utilization category acc. to EN IEC 60947-5-2	DC-13 24 V 400mA Caution: outputs must be protected with a free-wheeling diode in case of inductive loads.			
Off-state current I_T	≤ 0.25			mA
Monitoring output $OUT^{1)}$	p-switching, short circuit-proof			
-Output voltage	$0.8 \times U_B$		U_B	V DC
-Max load	-		200	mA
Rated insulation voltage U_i	-	-	$300^{2)}$	V
Rated impulse withstand voltage U_{imp}	-	-	1.5	kV
Conditional short-circuit current	100			A
Resilience to vibration	In acc. with EN IEC 60947-5-2			
Switching frequency	-	-	1	Hz
Repeat accuracy	≤ 10			%
EMC protection requirements	In acc. with EN IEC 60947-5-3 and EN IEC61326-3-1			
Ready delay	-	8	-	s
Risk time for single device	-	-	260	ms
Delay of the risk time per device	5			ms
Switch-on time of safety outputs	-	-	400	ms
Simultaneity monitoring, safety inputs	-	-	150	ms
Discrepancy time	-	-	10	ms
Test-pulse duration at the safety outputs	1			ms
Reliability values according to EN ISO 13849-1				
Category	4			
Performance Level	PL e			
PFH_D	$2.1 \times 10^{-9}/h^{3)}$			
Mission time	20			years

1) Values at a switching current of 50mA without taking into account the cable lengths.

2) Tested by employers' liability insurance association up to 75V.

Typical system times

Please refer to the technical data for exact values.

Ready delay: After switching on, the unit carries out a self-test. The system is ready for operation only after this time.

Switch-on time of safety outputs: The max. reaction time t_{on} is the time from the moment when the actuator is in the operating distance (safety guard closed) to the moment when the safety outputs switch on.

Simultaneity monitoring, safety inputs (Enable inputs IA/IB): If the safety inputs have different switching states over a certain time, the safety outputs (OA and OB) will be switched off. The device switches to fault state.

Risk time according to EN 60947-5-3: If an actuator moves outside the operating distance, the safety outputs (OA and OB) are deactivated at the latest after the discrepancy time.

Discrepancy time: The safety outputs (OA and OB) switch with a slight time offset. They assume the same signal state at the latest after the discrepancy time.

Test-pulse duration at the safety outputs: The device generates its own test pulses on the output lines OA/OB. A downstream control system must tolerate these test pulses.

This can usually be set up in the control systems by parameter assignment. The pulses are also output when the safety outputs are switched off.

Dimension drawings and connector assignments

Sensor head
HS3A-H21M4

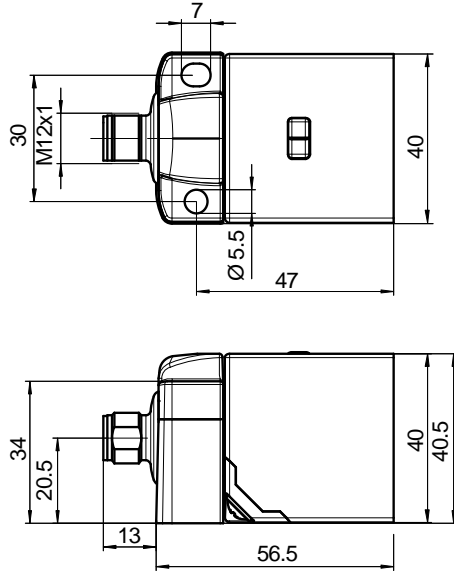

Mounting screws are not supplied with the sensor head and must be provided by the user. Use stainless steel or non-metallic screws. (1 N·m M5)

Terminating plug HS9Z-H3TP
4-pin, plug

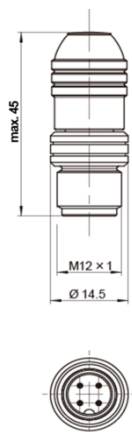

Connector assignment for
HS3A-H21M4
(8-pin plug)
and
Y-distributor (8-pin socket)

Pin	Function
1	IB
2	UB
3	OA
4	OB
5	OUT
6	IA
7	0V
8	RST

Y-distributor HS9Z-H3YD

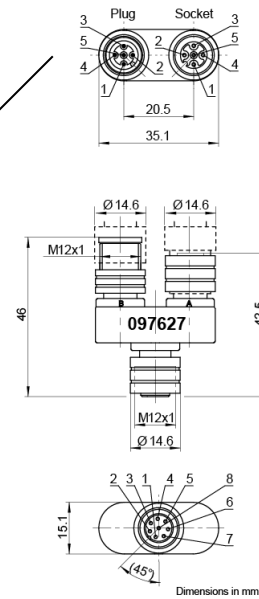

Pin	Function
1	UB
2	OA
3	0V
4	OB
5	RST

Pin	Function
1	UB
2	IA
3	0V
4	IB
5	RST

Figure 10

Technical data for actuator HS9Z-ZH31

Parameter	Value			Unit
	min.	typ.	max.	
Housing material	PBT			
Dimensions	40x40x10			mm
Weight	0.025			kg
Ambient temperature	-25	-	+70	°C
Degree of protection acc. To EN IEC 60529	IP 67/IP 69K			
Installation position	Active face opposite read head			
Power supply	Inductive via read head			

Dimension drawing

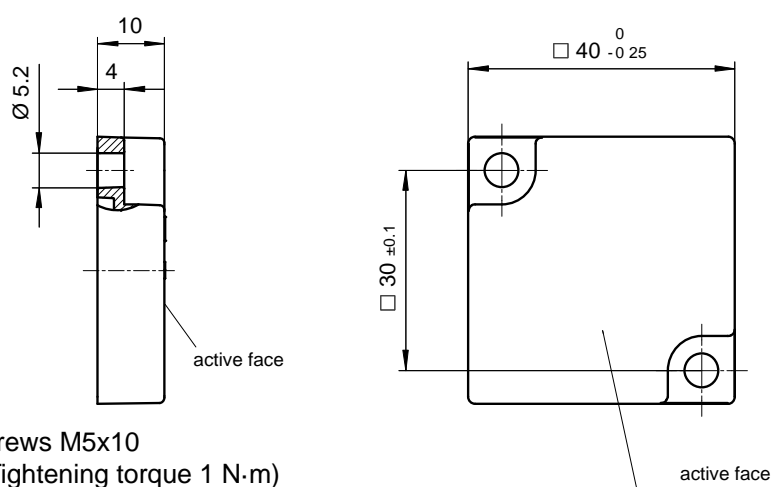

2 safety screws M5x10
Included (Tightening torque 1 N·m)

Figure 13

Note: When tightening safety screws, it will be impossible to remove them.

Operating distances

Operating distance for center offset $m = 0$

(Only in conjunction with actuator HS9Z-ZH31 on surface mounting)

Parameter	Value			Unit
	min.	typ.	max.	
Switch-on distance	-	15 ¹⁾	-	mm
Assured switch-on distance S_{ao}	13	-	-	
Switching hysteresis	1.5	2.5	-	
Assured switch-off distance S_{ar}	-	-	58	

1) On surface mounting on aluminum, in a non-metallic environment the typical switching distance increases to 30mm.

Typical operating distance

(Only in conjunction with actuator HS9Z-ZH31 on surface mounting)

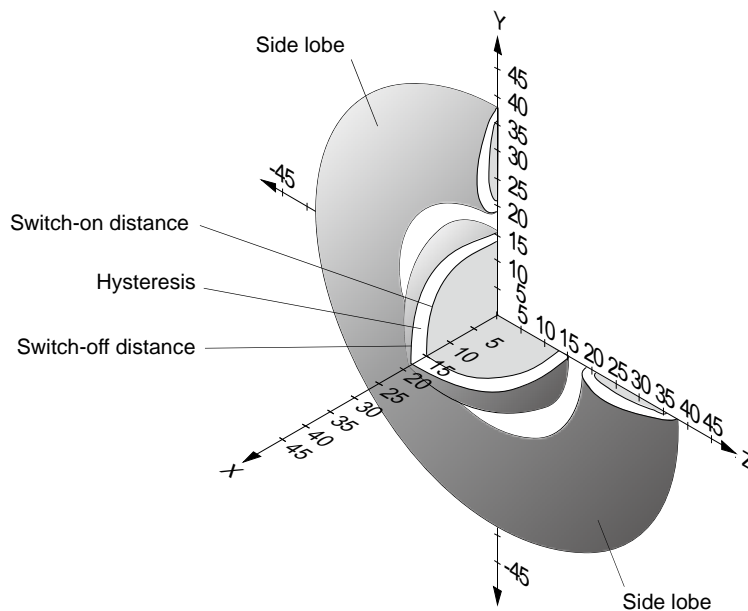

For a side approach direction for the actuator and safety switch, a minimum distance of $s = 6\text{mm}$ must be maintained so that the operating distance of the side lobe is not entered.

Figure 14: Typical operating distance

Ordering Information and Accessories

Designation	Version	Order No.
Sensor head	Unicode	HS3A-H21U4
	Multicode	HS3A-H21M4
Actuator	40mmx40mm	HS9Z-ZH31
Terminal plug	M12, 4-pin, plug	HS9Z-H3TP
Y-distributor	M12, 1x8-pin, 2x5-pin	HS9Z-H3YD
Connection cable	M12 female plug 8-pin, length 5m	HS9Z-H3F805
	M12 female plug 8-pin, length 10m	HS9Z-H3F810
	M12 female plug 5-pin, length 5m	HS9Z-H3F505
	M12 female plug 5-pin, length 10m	HS9Z-H3F510
	M12 female plug 5-pin to M12 male plug, length 5m	HS9Z-H3F5M05
	M12 female plug 5-pin to M12 male plug, length 10m	HS9Z-H3F5M10

Inspection and Service

Warning!

Loss of the safety function because of damage of system.
In case of damage the related component must be replaced completely. The replacement of individual parts in a safety component is not permitted.

Regular inspection of the following is necessary to ensure trouble-free long-term operation:

- ▶ Check the switching function (see section *Functional check on page 22*)
- ▶ Check the secure fastening of the devices and the connections
- ▶ Check for soiling

No servicing is required, repairs to the device are only allowed to be made by the manufacturer.

Note!

The last two digits of the year of manufacture can be seen in the lower right corner of the rating plate.

The safety guard must be re-adjusted when the device indicates that the actuator is in the boundary area.

Service

If service support is required, please contact:

IDEC CORPORATION

6-64, Nishimiyahara 2-chome, Yodogawa-ku, Osaka 532-0004, Japan

APEM GmbH

Heselstuecken 8, 22453 Hamburg, Germany

<http://www.idec.com>

November, 2018

Declaration of Conformity

(Copy of the original EU-Declaration of Conformity, Document No.: D1B119, D3B041,D5B036)

Identification of the Product	Non-contact Interlock Switches
Name and address of Manufacturer IDEC CORPORATION 2-6-64 Nishimiyahara, Yodogawa-Ku, Osaka 532-0004 Japan	Name and address of the authorized representative : APEM GmbH Heseltuecken 8, 22453 Hamburg, Germany
This declaration of conformity is issued under the sole responsibility of the manufacturer.	
Object of the declaration : Series Name - HS3A Series Model No. – Safety Switch: HS3A-H21M4, HS3A-H12U4 Actuator: HS9Z-ZH31	
The object of the declaration described above is in conformity with the relevant EU harmonization legislation : 2006/42/EC Machinery Directive 2014/53/EU Radio Equipment Directive 2011/65/EU Restriction of the use of certain hazardous substances (RoHS) Directive	
The safety objectives of the Low-voltage Directive 2014/35/EU and EMC Directive 2014/30/EU comply with article 3.1 of the Radio Equipment Directive.	
Applied Union harmonized legislation and references to the relevant harmonization standards used or references the other technical specifications in relation to which conformity is declared. EN 60947-5-3:2013 EN ISO 14119:2013 EN ISO 13849-1:2015 EN 50364:2010 EN 300 330 V2.1.1 EN 50581:2012	
Where applicable, the notified body DGUV Test Prüf- und Zertifizierungsstelle Fachausschuss Elektrotechnik (NB No. 0340) Gustav-Heinemann-Ufer 130, 50968 Köln, Germany	
Additional Information : No. of certificate ET 18069	