

INSTRUCTION MANUAL

Light Curtain Type 4
SE4D Series

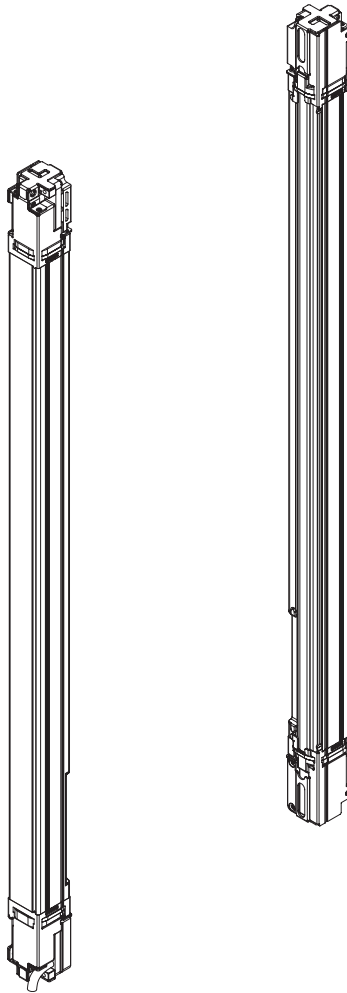

(MEMO)

Thank you for purchasing IDEC's Light Curtain, **SE4D** series.

Please read this instruction manual carefully and thoroughly for the correct and optimum use of this device.

Kindly keep this manual in a convenient place for quick reference.

This device is a light curtain for protecting a person from dangerous parts of a machine which can cause injury or accident.

This manual has been written for the following personnel who have undergone suitable training and have knowledge of light curtains, as well as, safety systems and standards.

- who are responsible for the introduction of this device
- who design the system using this device
- who install and connect this device
- who manage and operate a plant using this device

Notes

- 1) All the contents of this instruction manual are the copyright of the publishers, and may not be reproduced (even extracts) in any form by any electronic or mechanical means (including photocopying, recording, or information storage and retrieval) without permission in writing from the publisher.
- 2) The contents of this instruction manual may be changed without prior notice for further improvement of the device.
- 3) Though we have carefully drawn up the contents of this instruction manual, if there are any aspects that are not clear, or any error that you may notice, please contact our local IDEC office of the nearest distributor.
- 4) English and Japanese are original instructions.



Contents

Chapter 1 Introduction	5
1-1 Attention Marks	5
1-2 Safety Precautions	5
1-3 Applicable Standards / Regulations	8
1-4 Confirmation of Packed Contents	9
Chapter 2 Before Using This Device	10
2-1 Features	10
2-2 Part Description	10
2-3 Protection Area	13
2-3-1 Sensing Area	13
2-3-2 Safety Distance	14
2-3-3 Influence of Reflective Surfaces	18
2-3-4 Device Placement	19
2-4 Mounting	20
2-4-1 Mounting of the Mounting Bracket	20
2-4-2 Mounting of the Bottom Cap Cable (Optional)	25
2-4-3 Extension and Dismantling of Sensor (Series Connection)	26
2-5 Wiring	28
2-5-1 Power Supply Unit	28
2-5-2 I/O Circuit Diagrams and Output Waveform	29
2-5-3 Wiring · Connecting Procedure and Connector Pin Arrangement	31
2-5-4 Basic Wiring	33
2-5-5 Wiring for Manual Reset (Interlock is Valid)	35
2-5-6 Series Connection	37
2-5-7 Parallel Connection	39
2-5-8 Series and Parallel Mixed Connection	43
2-5-9 Wiring for Auto-reset (Interlock is Invalid)	48
2-5-10 Wiring Configuration for Invalid External Device Monitor Function	50
2-5-11 Wiring Configuration for Valid Muting Function	52
2-6 Adjustment	54
2-6-1 Beam-axis Alignment	54
2-6-2 Operation Test	56
2-6-3 Operation	57
Chapter 3 Functions	64
3-1 Self-diagnosis Function	64
3-2 Interlock Function	64
3-3 Emission Halt Function	65
3-4 Interference Prevention Function	65
3-5 Auxiliary Output (Non-safety Output)	66
3-6 External Device Monitor Function	66
3-7 Muting Function	68
3-8 Override Function	71
3-9 Functions Using Handy Controller (SE9Z-HC) (Optional)	72

Chapter 4 Maintenance	75
4-1 Daily Inspection	75
4-2 Periodic Inspection (Every Six Months)	76
4-3 Inspection after Maintenance	76
Chapter 5 Troubleshooting	77
5-1 Troubleshooting of Emitter	77
5-2 Troubleshooting of Receiver	79
Chapter 6 Specifications / Dimensions	81
6-1 Specifications	81
6-2 Options	84
6-3 Dimensions	86
6-3-1 Rear Mounting with Standard Mounting Bracket (SE9Z-SED-1)	86
6-3-2 Side Mounting with Standard Mounting Bracket (SE9Z-SED-1)	87
6-3-3 Rear Mounting with Dead Zoneless Mounting Bracket (SE9Z-SED-3)	88
6-3-4 Side Mounting with Dead Zoneless Mounting Bracket (SE9Z-SED-3)	89
6-3-5 Mounting Brackets	90
Chapter 7 Others	92
7-1 Glossary	92
7-2 CE Marking Declaration of Conformity	94

Chapter 1 Introduction

1-1 Attention Marks

This instruction manual employs the following attentions marks ,  depending on the degree of the danger to call operator's attention to each particular action. Read the following explanation of these marks thoroughly and observe these notices without fail.

 **WARNING** If you ignore the advice with this mark, death or serious injury could result.

 **CAUTION** If you ignore the advice with this mark, injury or material damage could result.

<Reference> It gives useful information for better use of this device.

1-2 Safety Precautions

- Use this device as per its specifications. Do not modify this device since its functions and capabilities may not be maintained and it may malfunction.
- This device has been developed / produced for industrial use only.
- This device is suitable for indoor use only.
- Use of this device under the following conditions or environments is not presupposed. Please consult us if there is no other choice but to use this device in such an environment.
 - 1) Operating this device under conditions or environments not described in this manual.
 - 2) Using this device in the following fields: nuclear power control, railroad, aircraft, auto mobiles, combustion facilities, medical systems, aerospace development, etc.
- When this device is to be used for enforcing protection of a person from any danger occurring around an operating machine, the user should satisfy the regulations established by national or regional security committees (Occupational Safety and Health Administration: OSHA, the European Standardization Committee, etc.). Contact the relative organization(s) for details.
- In case of installing this device to a particular machine, follow the safety regulations in regard to appropriate usage, mounting (installation), operation and maintenance. The users including the installation operator are responsible for the introduction of this device.
- Use this device by installing suitable protection equipment as a countermeasure for failure, damage, or malfunction of this device.
- Before using this device, check whether the device performs properly with the functions and capabilities as per the design specifications.
- In case of disposal, dispose this device as an industrial waste.

WARNING

◆ **Machine designer, installer, employer and operator**

- The machine designer, installer, employer and operator are solely responsible to ensure that all applicable legal requirements relating to the installation and the use in any application are satisfied and all instructions for installation and maintenance contained in the instruction manual are followed.
- Whether this device functions as intended to and systems including this device comply with safety regulations depends on the appropriateness of the application, installation, maintenance and operation. The machine designer, installer, employer and operator are solely responsible for these items.

◆ **Engineer**

- The engineer would be a person who is appropriately educated, has widespread knowledge and experience, and can solve various problems which may arise during work, such as a machine designer, or a person in charge of installation or operation etc.

◆ **Operator**

- The operator should read this instruction manual thoroughly, understand its contents, and perform operations following the procedures described in this manual for the correct operation of this device.
- In case this device does not perform properly, the operator should report this to the person in charge and stop the machine operation immediately. The machine must not be operated until correct performance of this device has been confirmed.

◆ **Environment**

- Do not use a mobile phone or a radio phone near this device.
- If there exists a reflective surface in the place where this device is to be installed, make sure to install this device so that reflected light from the reflective surface does not enter into the receiver, or take countermeasures such as painting, masking, roughening, or changing the material of the reflective surface, etc. Failure to do so may cause the device not to detect, resulting in death or serious injury.
- Do not install this device in the following environments.
 - 1) Areas exposed to intense interference (extraneous) light such as high-frequency fluorescent lamp (inverter type), rapid starter fluorescent lamp, stroboscopic lights or direct sunlight.
 - 2) Areas with high humidity where condensation is likely to occur
 - 3) Areas exposed to corrosive or explosive gases
 - 4) Areas exposed to vibration or shock of levels higher than that specified
 - 5) Areas exposed to contact with water
 - 6) Areas exposed to too much steam or dust

◆ **Installation**

- Always keep the correctly calculated safety distance between this device and the dangerous parts of the machine.
- Install extra protection structure around the machine so that the operator must pass through the sensing area of this device to reach the dangerous parts of the machine.
- Install this device such that some part of the operator's body always remains in the sensing area when operator is done with the dangerous parts of the machine.
- Do not install this device at a location where it can be affected by wall reflection.
- When installing multiple sets of this device, connect the sets and, if necessary, install some barriers such that mutual interference does not occur. For details, refer to "**2-3-4 Device Placement**" and "**3-4 Interference Prevention Function.**"
- Do not use this device in a reflective configuration.
- The corresponding emitter and receiver must have the same serial No. and be correctly oriented.

 **WARNING**

◆ **Machine in which this device is installed**

- When this device is used in the “PSDI Mode,” an appropriate control circuit must be configured between this device and the machinery. For details, be sure to refer to the standards or regulations applicable in each region or country.
- In Japan and Korea, do not use this device as safety equipment for a press machine.
- Do not install this device with a machine whose operation cannot be stopped immediately in the middle of an operation cycle by an emergency stop equipment.
- This device starts the performance after 2 seconds from the power ON. Have the control system started to function with this timing.

◆ **Wiring**

- Be sure to carry out the wiring in the power supply OFF condition.
- All electrical wiring should conform to the regional electrical regulations and laws. The wiring should be done by engineer(s) having the special electrical knowledge.
- Do not run the wires together with high-voltage lines or power lines or put them in the same raceway. This can cause malfunction due to induction.
- Do not control the device only at one control output (OSSD 1 / 2).
- In order that the output is not turned to ON due to earth fault of the control output (OSSD 1 / 2) wires, be sure to ground to 0V side (PNP output) / +24V side (NPN output).

◆ **Maintenance**

- When replacement parts are required, always use only genuine supplied replacement parts. If substitute parts from another manufacturer are used, the device may not come to detect, result in death or serious injury.
- The periodical inspection of this device must be performed by an engineer having the special knowledge.
- After maintenance or adjustment, and before starting operation, test this device following the procedure specified in “**Chapter 4 Maintenance.**”
- Clean this device with a clean cloth. Do not use any volatile chemicals.

◆ **Others**

- Never modify this device. Modification may cause the device not to detect, resulting in death or serious injury.
- Do not use this device to detect objects flying over the sensing area.
- Do not use this device to detect transparent objects, translucent objects or objects smaller than the specified minimum sensing objects.

1-3 Applicable Standards / Regulations

This device complies with the following standards / regulations.

<EU Directives>

EU Machinery Directive 2006/42/EC
EMC Directive 2014/30/EU

<European Standards>

EN 61496-1 (Type 4), EN 55011, EN 61000-6-2, EN 50178
EN ISO 13849-1: 2008 (Category 4, PLe)

<International Standards>

IEC 61496-1/2 (Type 4), ISO 13849-1: 2006 (Category 4, PLe), IEC 61508-1~7 (SIL3)

<Japanese Industrial Standards (JIS)>

JIS B 9704-1/2 (Type 4), JIS B 9705-1 (Category 4), JIS C 0508 (SIL3)

<Standards in US / Canada>

ANSI/UL 61496-1/2 (Type 4), ANSI/UL 508, UL 1998 (Class 2)
CAN/CSA C22.2 No.14, CAN/CSA C22.2 No.0.8

<Regulations in US>

OSHA 1910.212, OSHA 1910.217(C), ANSI B11.1 to B11.19, ANSI/RIA 15.06

Regarding EU Machinery Directive, a Notified Body, TUV SUD, has certified with the type examination certificate.

With regard to the standards in US / Canada, a NRTL, UL (Underwriters Laboratories Inc.) has certified for UL/c-UL Listing Mark.

<Reference>

The conformity to JIS, OSHA and ANSI for this device has been evaluated by ourselves.

WARNING

- In Japan, never use this device as a safety equipment for any press machine or shearing machine.
- When this device is used in a place other than the places shown above, be sure to confirm the standards or regulations applicable in each region or country before use

Before the use of this device, construct the control system that satisfies the following requirements to secure the safety of the whole system.

To use for Category 4 or 3

- **To prevent the loss of the safety function due to a single fault.**
Always use two types of control output (OSSD 1 / 2).
 - **To prevent the loss of the safety function due to the accumulation of the faults.**
Construct the control system that can stop a device if discrepancy between control outputs (OSSD 1 / 2) is detected.
- <The example of the way to detect the discrepancy of control outputs>**
(Example 1) Use the relay unit or the controller for the light curtain.
(Example 2) Monitor of the control outputs (OSSD 1 / 2) with the safety PLC.
(Example 3) Monitor of the contact point welding in case the safety relay is used.

To use for Category 2

If one type of control output (OSSD) is used, the auxiliary output connects to PLC to monitor the operation of this device, and construct the control system that can stop a device if discrepancy between the control output (OSSD) and the auxiliary output is detected. It is possible to use another type of control output (OSSD) .

1-4 Confirmation of Packed Contents

- Sensor: Emitter, Receiver 1 pc. each
 - Test Rod : **SE9Z-TR25** (ø25 × 220mm) 1 pc.
 - Intermediate Supporting Bracket (**SE9Z-SED-2**) 0 to 3 sets
- Note: The intermediate support bracket (**SE9Z-SED-2**) is enclosed with the following devices. The quantity differs depending on the device as shown below:
- 1 set: 40 to 56 beam channels
 - 2 sets: 64 to 80 beam channels
 - 3 sets: 88 to 96 beam channels
- Quick Instruction Manual 1 pc.
 - CD-ROM (Instruction Manual)

Chapter 2 Before Using This Device

2-1 Features

This device is the light curtain with the following features.

- No special controller is required.
- The control output (OSSD 1 / 2) is PNP / NPN output switching type.
- Beam-axis alignment indicators which make beam-axis alignment easy are incorporated.
- Each function setting is available by using the handy controller (**SE9Z-HC**) (optional). Refer to “3-9 Functions Using Handy Controller (**SE9Z-HC**) (Optional)” for details.
- Refer to “6-2 Options” for details of options.

2-2 Part Description

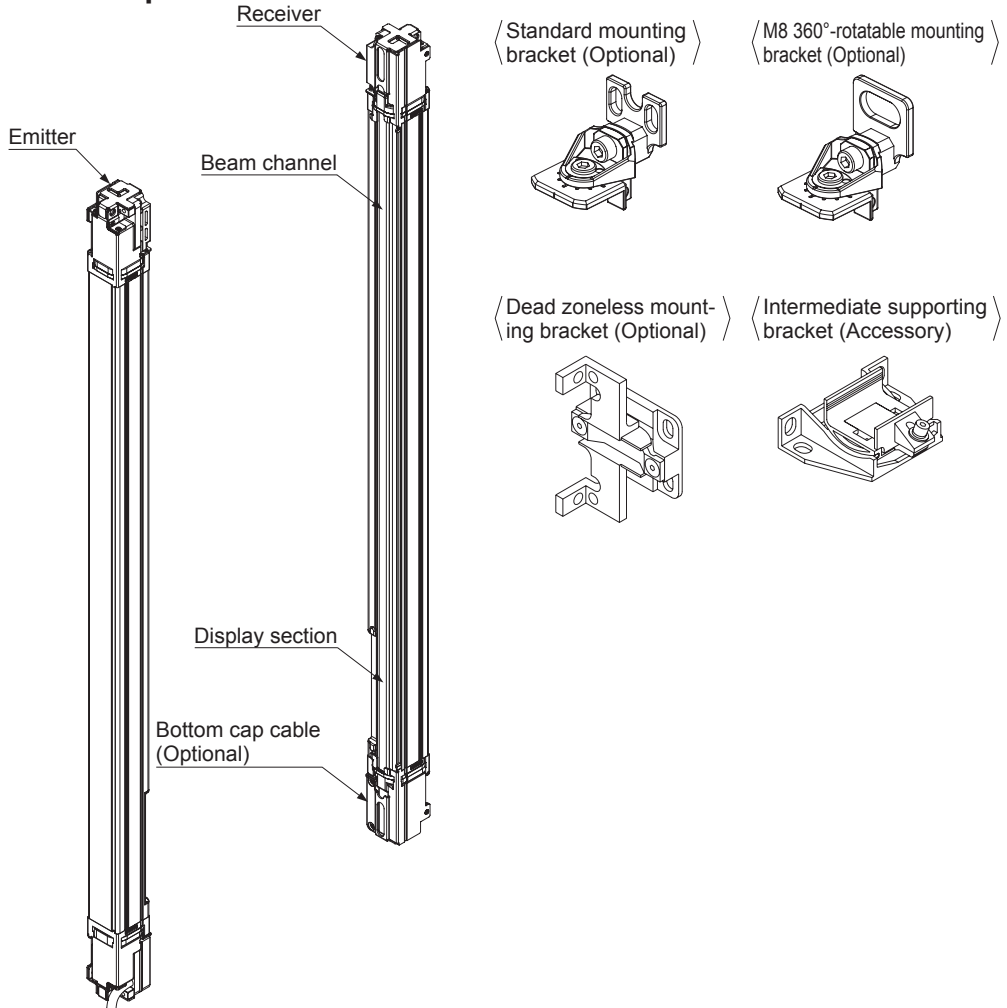

<Emitter>

It emits light to the receiver facing it. Furthermore, the status of the emitter and the receiver is indicated on its display section.

<Receiver>

It receives light from the emitter facing it. Simultaneously, it turns ON the control output (OSSD 1 / 2) when the all beam channels receive light from emitter, and it turns OFF the control output (OSSD 1 / 2) when one or more beam channels are blocked light.

[Exclude when using the muting function (Note 1) or the blanking function (Note 2).]

Besides, the receiver displays its status on the display section.

- Notes: 1) In case of using the muting function, the following items, 12-core bottom cap cable (**SE9Z-CB05-MU**, **SE9Z-CCB□-MU**) (optional), muting sensor and muting lamp are required. Please purchase 12-core bottom cap cable, muting sensor, and muting lamp separately.
- 2) The blanking function is set by using the handy controller (**SE9Z-HC**) (optional). Please purchase the handy controller separately.

<Beam channel>

The light emitting elements of the emitter and the light receiving elements of the receiver are placed at 20mm intervals.

<Standard mounting bracket (optional)>

This bracket is to be used for mounting the emitter / receiver. It is installed using two M5 hexagon-socket head bolts or one M8 hexagon-socket head bolt. 360° horizontal angle rotation can be done.

<M8 360°-rotatable mounting bracket (optional)>

This bracket is to be used for mounting the emitter / receiver. It is installed using one M8 hexagon-socket head bolt. 360° horizontal angle rotation can be done.

<Dead zoneless mounting bracket (optional)>

This bracket is to be used for mounting the emitter / receiver. This is useful for mounting the device to the limited mounting space.

<Intermediate supporting bracket>

This bracket is to be used for mounting the device having 40 beam channels or more.

<Display section>

Emitter

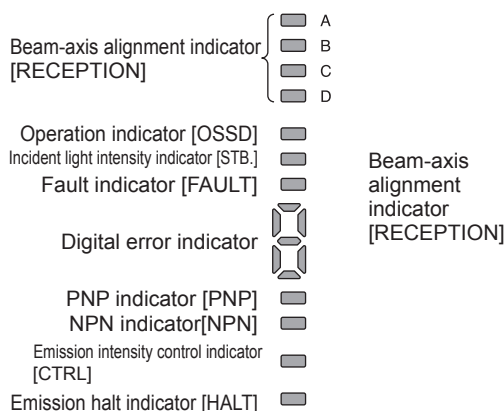

Receiver

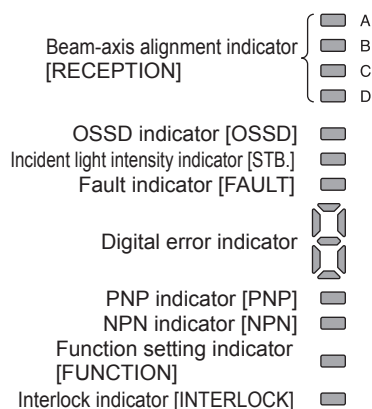

Description	Function
Beam-axis alignment indicator (Red / Green) [RECEPTION]	A When device top receives light: lights up in red When device top end receives light: blinks in red When control output (OSSD 1 / 2) is ON: lights up in green
	B When device upper middle receives light: lights up in red When control output (OSSD 1 / 2) is ON: lights up in green
	C When device lower middle receives light: lights up in red When control output (OSSD 1 / 2) is ON: lights up in green
	D When device bottom receives light: lights up in red When device bottom end receives light: blinks in red When control output (OSSD 1 / 2) is ON: lights up in green
Operator indicator (Red / Green) [OSSD] (Note 1)	Lights up while device operation is as follows [sequential operation control output (OSSD1 / 2)] When control output (OSSD 1 / 2) is OFF: lights up in red When control output (OSSD 1 / 2) is ON: lights up in green
Incident light intensity indicator (Orange / Green) [STB.]	When sufficient light is received (Incident light: 130% or more) (Note 2): lights up in green When stable light is received (Incident light: 115 to 130%) (Note 2): OFF When unstable light is received (Incident light : 100 to 115%) (Note 2): lights up in orange When light is blocked: OFF (Note 3)
Fault indicator (Yellow) [FAULT]	When fault occurs in the device: lights up or blinks
Digital error indicator (Red)	When device is lockout, error contents are indicated. When the sensors are connected in parallel, the bottom of the digital error indicator on the slave side sensors lights up in red.
PNP indicator (Orange) [PNP]	When PNP output is set: lights up
NPN indicator (Orange) [NPN]	When NPN output is set: lights up
Emission intensity control indicator (Orange) [CTRL]	When light is emitted under short mode: lights up When light is emitted under normal mode: OFF
Emission halt indicator (Orange) [HALT]	When light emission is halt: lights up When light is emitted: OFF

Description	Function
Beam-axis alignment indicator (Red / Green) [RECEPTION]	A When device top receives light: lights up in red When device top end receives light: blinks in red When control output (OSSD 1 / 2) is ON: lights up in green
	B When device upper middle receives light: lights up in red When control output (OSSD 1 / 2) is ON: light up in green
	C When device lower middle receives light: lights up in red When control output (OSSD 1 / 2) is ON: lights up in green
	D When device bottom receives light: lights up in red When device bottom end receives light: blinks in red When control output (OSSD 1 / 2) is ON: lights up in green
OSSD indicator (Red / Green) [OSSD]	When control output (OSSD 1 / 2) is OFF: lights up in red When control output (OSSD 1 / 2) is ON: lights up in green
Incident light intensity indicator (Orange / Green) [STB.]	When sufficient light is received (Incident light: 130% or more) (Note 2): lights up in green When stable light is received (Incident light: 115 to 130%) (Note 2): OFF When unstable light is received (Incident light : 100 to 115%) (Note 2): lights up in orange When light is blocked: OFF (Note 3)
Fault indicator (Yellow) [FAULT]	When fault occurs in the device: light up or blinks
Digital error indicator (Red)	When device is lockout, error contents are indicated. When the sensors are connected in parallel, the bottom of the digital error indicator on the slave side sensors lights up in red.
PNP indicator (Orange) [PNP]	When PNP output is set: light up
NPN indicator (Orange) [NPN]	When NPN output is set: lights up
Function setting indicator (orange) [FUNCTION]	When blanking function is used: lights up (Note 4) When connecting the handy controller: brinks
Interlock indicator (Yellow) [INTERLOCK]	When device is interlocked: lights up Other cases: OFF

Notes: 1) Since the color of the operation indicator changes according to ON / OFF status of the control output (OSSD 1 / 2), the operation indicator is marked as "OSSD" on the device.

- 2) The threshold where the control output (OSSD 1 / 2) changes from OFF to ON is applied as "100% incident light intensity".
- 3) "When light is blocked" refers to the status that there exists any object blocking light in the sensing area.
- 4) The blanking function is set by using the handy controller (**SE9Z-HC**) (optional). Please purchase the handy controller separately.
- 5) The description given in [] is marked on the device.

2-3 Protection Area

2-3-1 Sensing Area

WARNING

- Be sure to install protection structure around the machine so that the operator must pass through the sensing area of this device to reach the dangerous parts of the machine. Furthermore, ensure that some part of the operator's body always remains in the sensing area when operation is done with the dangerous parts of the machine. Failure to do so can result in death or serious injury.
- Do not use any reflection type or recursive reflection type arrangement.
- Furthermore, facing several receivers towards one emitter, or vice versa, could produce a non-sensing area or cause mutual interference, which may result in death or serious injury.

The sensing area is the zone formed by the sensing height of the device and the sensing range between the emitter and the receiver. The sensing height is determined by the number of beam channels. Furthermore, the sensing range can be 0.3 to 9m for 12 to 64 beam channels and 0.3 to 7m for 72 to 96 beam channels. Take care that if the sensing range is under 0.3m, malfunction may occur due to the optical structure.

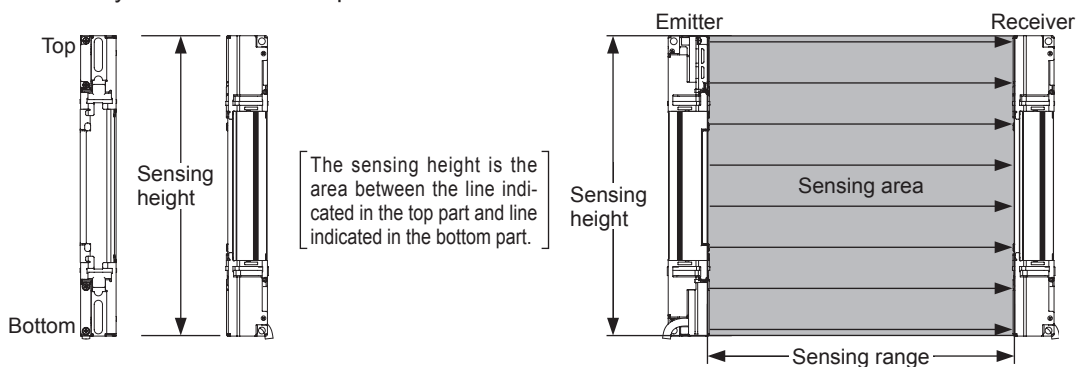

<Example of Correct Installation>

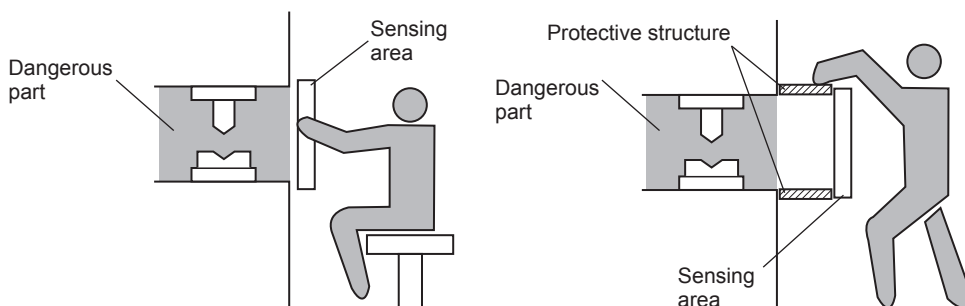

<Example of Incorrect Installation>

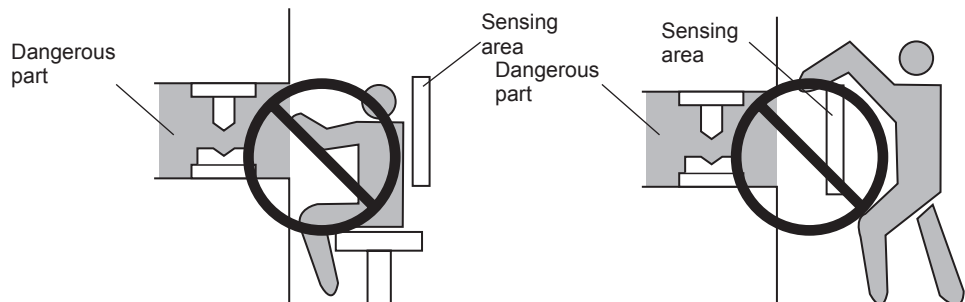

2-3-2 Safety Distance

⚠ WARNING

Calculate the safety distance correctly, and always maintain the distance which is equal to or greater than the safety distance, between the sensing area of this device and the dangerous parts of the machine. If the safety distance is miscalculated or if sufficient distance is not maintained, the machine will not stop quickly before reaching to the dangerous parts, which can result in death or serious injury.

The safety distance is the minimum distance that must be maintained between the device and the dangerous parts of the machine so that the machine can be stopped before a human body or an object can reach the dangerous parts.

The safety distance is calculated based on the equation described in the next page when a person moves perpendicular (normal intrusion) to the sensing area of the device.

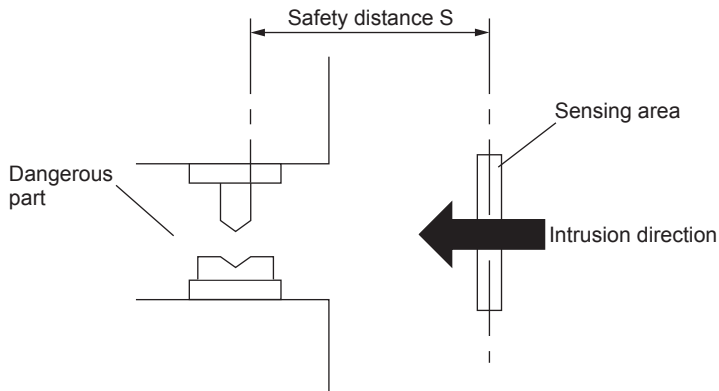

⚠ WARNING

Before designing the system, refer to the relevant standards of the region where this device is to be used, and then install this device.

Furthermore, the equation described in the next pages is to be used only in case the intrusion direction is perpendicular to the sensing area. In case the intrusion direction is not perpendicular to the sensing area, be sure to refer to the relevant standard (regional standard, specification of the machine, etc.) for details of the calculation.

⚠ WARNING

The max. response time of the machine is from the point that the machine receives the halt signal from this device to the point that the dangerous parts of the machine stops. The max. response time of the machine should be timed with the machine to be actually used.

⚠ WARNING

The size of the minimum sensing object for this device varies depending on the case whether the floating blanking function is applied or not. Calculate the safety distance with the proper size of the minimum sensing object and appropriate equation.

<Size of minimum sensing object when applying floating blanking function>

	Floating blanking function			
	Invalid	Setting (Note)		
		1 beam channel	2 beam channels	3 beam channels
SE4D-H□ (20mm-beam channel pitch type)	ø25mm	ø45mm	ø65mm	ø85mm

Note: Refer to "3-9 Functions Using Handy Controller (SE9Z-HC) (Optional)" for details of the floating blanking function.

[For use in Europe (EU) (as EN 999)] (Also applicable to ISO 13855)

(For intrusion direction perpendicular to the sensing area)

<In case that the minimum sensing object is ø40mm or less>

- Equation 1 $S = K \times T + C$

S : Safety distance (mm)

Minimum required distance between the sensing area surface and the dangerous parts of the machine

K : Intrusion velocity of operator's body or object (mm/sec.)

Taken as 2,000 (mm/sec.) for calculation

T : Response time of total equipment (sec.)

$T = T_m + T_{SE4D}$

T_m : Maximum halting time of machine (sec.)

T_{SE4D} : Response time of this device (sec.)

C : Additional distance calculated from the size of the minimum sensing object of the device (mm)

However, the value of C cannot be under 0.

$C = 8 \times (d - 14)$

d: Minimum sensing object diameter (mm)

<Reference>

- For calculating the safety distance S, there are the following five cases. First calculate by substituting the value $K = 2,000$ (mm/sec.) in the equation above. Then, classify the obtained value of S into three cases, 1) $S < 100$, 2) $100 \leq S \leq 500$, and 3) $S > 500$. For Case 3) $S > 500$, recalculate by substituting the value $K = 1,600$ (mm/sec.). After that, classify the calculation result into two cases, 4) $S \leq 500$ and 5) $S > 500$. For details, refer to "Calculation Example 1 For use in Europe."
- When this device is used in the "PSDI Mode," an appropriate safety distance S must be calculated. For details, be sure to refer to the standards or regulations applicable in each region or country.

<In case that the minimum sensing object is over ø40mm>

- Equation $S = K \times T + C$

S : Safety distance (mm)

Minimum required distance between the sensing area surface and the dangerous parts of the machine

K : Intrusion velocity of operator's body or object (mm/sec.)

Taken as 1,600 (mm/sec.) for calculation

T : Response time of total equipment (sec.)

$T = T_m + T_{SE4D}$

T_m : Maximum halting time of machine (sec.)

T_{SE4D} : Response time of this device (sec.)

C : Additional distance calculated from the size of the minimum sensing object of the device (mm)

$C = 850$ (mm)

<Calculation Example>

- Calculation Example 1: For use in Europe
(OFF response time: 14ms or less, minimum sensing object diameter: 25mm)

First, calculate with $K = 2,000$.

$$\begin{aligned} S &= K \times T + C \\ &= K \times (T_m + T_{SE4D}) + 8 \times (d - 14) \\ &= 2,000 \times (T_m + 0.014) + 8 \times (25 - 14) \\ &= 2,000 \times T_m + 2,000 \times 0.014 + 88 \\ &= 2,000 \times T_m + 116 \end{aligned}$$

If the result is:

- 1) In case $S < 100$ (mm)
Safety distance S is taken as 100 (mm)
- 2) In case $100 \leq S \leq 500$ (mm)
Safety distance S is taken as $2,000 \times T_m + 116$ (mm)
- 3) In case $S > 500$ (mm)
$$\begin{aligned} S &= K' \times (T_m + T_{SE4D}) + 8 \times (d - 14) \\ &= 1,600 \times (T_m + 0.014) + 8 \times (25 - 14) \\ &= 1,600 \times T_m + 1,600 \times 0.014 + 88 \\ &= 1,600 \times T_m + 110.4 \end{aligned}$$

then, calculate again.

If the result is:

- 4) In case $S \leq 500$ (mm)
Safety distance S is taken as 500 (mm)
- 5) In case $S > 500$ (mm)
Safety distance S is taken as $1,600 \times T_m + 110.4$ (mm)

In case this device is installed in a system with a maximum halting time of 0.1 (sec.)

$$\begin{aligned} S &= 2,000 \times T_m + 116 \\ &= 2,000 \times 0.1 + 116 \\ &= 316 \end{aligned}$$

Since this value matches with Case 2) above, S is 316 (mm).

In case this device is installed in a system with a maximum halting time of 0.4 (sec.)

$$\begin{aligned} S &= 2,000 \times T_m + 116 \\ &= 2,000 \times 0.4 + 116 \\ &= 916 \end{aligned}$$

Since this value matches with Case 3) above,

$$\begin{aligned} S &= 1,600 \times T_m + 110.4 \\ &= 1,600 \times 0.4 + 110.4 \\ &= 750.4 \end{aligned}$$

Since this value matches with Case 5) above, S is 750.4 (mm).

[For use in the United States of America (as per ANSI B11.19)]

● Equation 2 $Ds = K \times (Ts + Tc + TSE4D + Tbm) + Dpf$

- Ds : Safety distance (mm)
Minimum required distance between the sensing area surface and the dangerous parts of the machine
- K : Intrusion speed {Recommended value in OSHA is 63 (inch/sec.) [≈ 1,600 (mm/sec.)] }
ANSI B11.19 does not define the intrusion speed “K”. When determining K, consider possible factors including physical ability of operators.
- Ts : Halting time calculated from the operation time of the control element (air valve, etc.) (sec.)
- Tc : Maximum response time of the control circuit required for functioning the brake (sec.)
- TSE4D: Response time of this device (sec.)
- Tbm : Additional halting time tolerance for the brake monitor (sec.)
The following equation holds when the machine is equipped with a brake monitor.
 $T_{bm} = T_a - (T_s + T_c)$
Ta: Setting time of brake monitor (sec.)
When the machine is not equipped with a brake monitor, it is recommended that 20% or more of (Ts + Tc) is taken as additional halting time.
- Dpf : Additional distance calculated from the size of the minimum sensing object of the device (mm)
SE4D-H□ Dpf = 61.2mm

$$\left[\begin{array}{l} Dpf = 3.4 \times (d - 0.276) \text{ (inch)} \\ \approx 3.4 \times (d - 7) \text{ (mm)} \\ d: \text{Minimum sensing object diameter } 0.985 \text{ (inch)} \approx 25 \text{ (mm)} \text{ **SE4D-H□** } \end{array} \right]$$

<Reference>

When the floating blanking function is applied, the minimum sensing object becomes large. According to ANSI B11.1, Dpf = 900mm (3ft) when d > 64mm (2.5 inches).

<Reference>

Since the calculation above is performed by taking 1 (inch) = 25.4 (mm), there is a slight difference between the representation in (mm) and that in (inch). Refer to the relevant standard for the details.

<Calculation Example>

- Calculation Example 2 For use in the United States of America

[OFF response time: 14ms or less, minimum sensing object diameter: 0.985 (inch) ≈ 25 (mm)]

$$\begin{aligned} Ds &= K \times (Ts + Tc + TSE4D + Tbm) + Dpf \\ &= 63 \times (Ta + 0.014) + 3.4 \times (d - 0.276) \text{ (inch)} \\ &= 63 \times (Ta + 0.014) + 3.4 \times (0.985 - 0.276) \\ &= 63 \times Ta + 63 \times 0.014 + 3.4 \times 0.709 \\ &= 63 \times Ta + 3.2926 \\ &\approx 63 \times Ta + 3.29 \text{ (inch)} \end{aligned}$$

In case this device is installed in a system with a maximum halting time 0.1 (sec.)

$$\begin{aligned} Ds &= 63 \times Ta + 3.29 \\ &= 63 \times 0.1 + 3.29 \\ &= 9.59 \text{ (inch)} \\ &\approx 243.586 \text{ (mm)} \end{aligned}$$

Hence, as per the calculations Ds is 243.6 (mm).

<Reference>

Since the calculation above is performed by taking 1 (inch) = 25.4 (mm), there is a slight difference between the representation in (mm) and that in (inch). Refer to the relevant standard for the details.

2-3-3 Influence of Reflective Surfaces

WARNING

If there exists a reflective surface in the place where this device is to be installed, make sure to install this device so that reflected light from the reflective surface does not enter into the receiver, or take countermeasures such as painting, masking, roughening, or changing the material of the reflective surface, etc. Failure to do so may cause the device not to detect, resulting in death or serious injury.

Install this device at a distance of at least A (m) (given below) away from reflective surfaces such as metal walls, floors, ceilings, workpieces, covers, panels or glass surfaces.

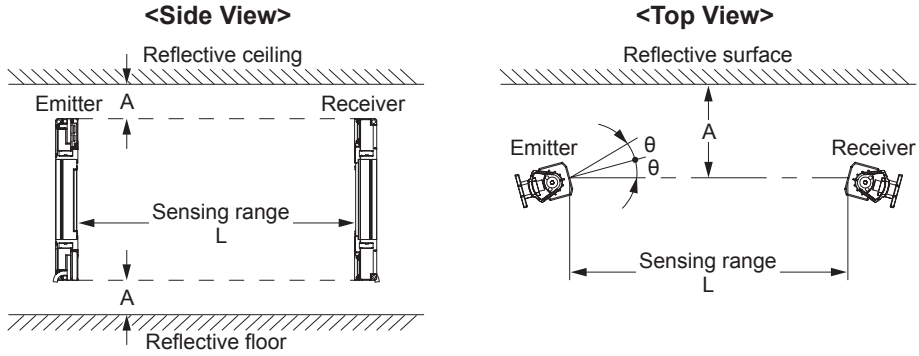

Distance between emitter and receiver (Sensing range L)	Allowable installation distance A
0.3 to 3m	0.16m
3 to 9m (Note 1)	$L/2 \times \tan 2\theta = L/2 \times 0.105 \text{ (m)} (\theta = 3^\circ)$

Notes: 1) The sensing range L is applicable to 12 to 64 beam channels. For 72 to 96 beam channels, the distance between emitter and receiver is 3 to 7m.

2) The effective aperture angle for this device is $\pm 2.5^\circ$ or less (when $L > 3\text{m}$) as required by IEC 61496-2, ANSI/UL 61496-2. However, install this device away from reflective surfaces considering an effective aperture angle of $\pm 3^\circ$ to take care of beam misalignment, etc. during installation.

Allowable Distance from This Device to Reflective Surface

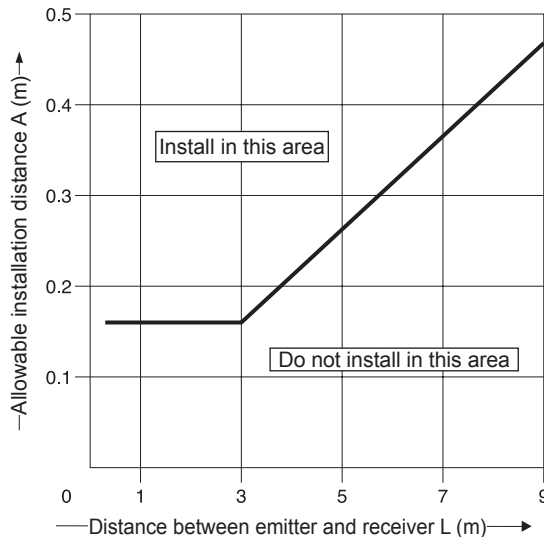

2-3-4 Device Placement

This is the configuration when two or more sets of emitter and receiver facing each other are placed without series or parallel connection between them. It is used for the case that there is a problem in wiring or for system evaluation in case of addition of equipment. Perform an operation test by referring to "2-6-2 Operation Test."

⚠ WARNING

- Refer to the examples of device placement given below and understand them thoroughly before installing the devices. Improper sensor placement could cause device malfunction, which can result in death or serious injury.
- If this device is used in multiple sets, arrange them to avoid mutual interference. If mutual interference occurs, it can result in death or serious injury.

<Example of device placement>

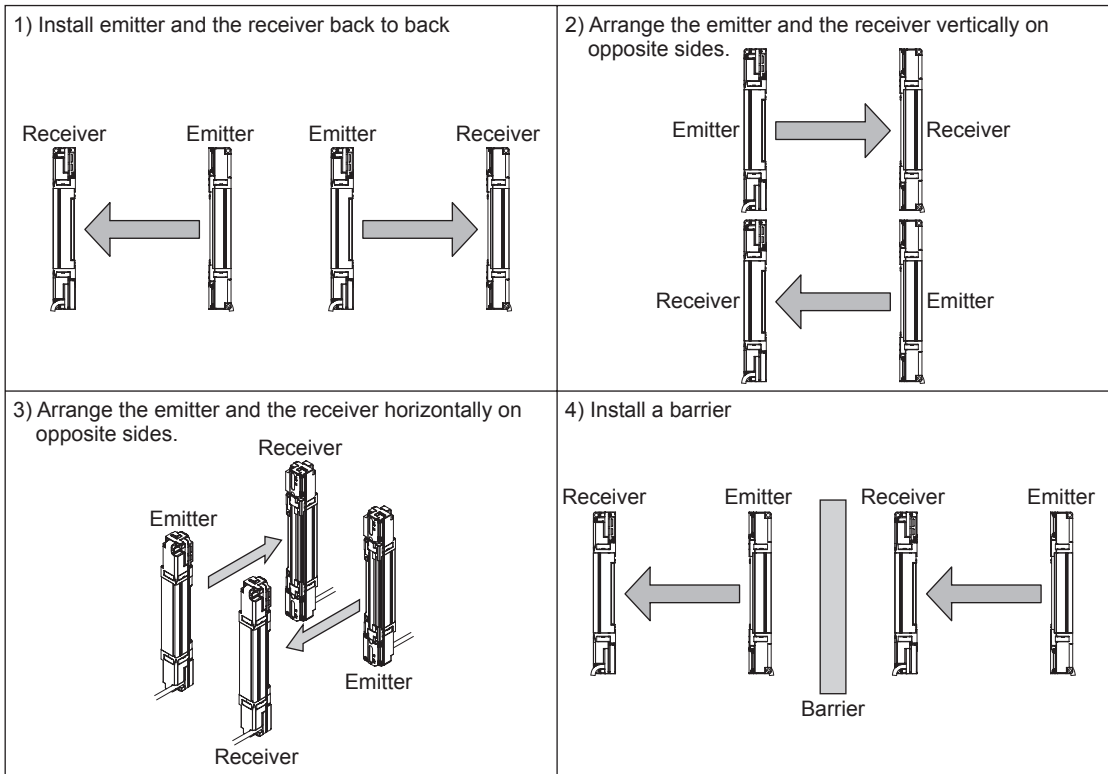

<Reference>

The above figures are just examples of device placement. If there are any questions or problems, please contact our office.

2-4 Mounting

2-4-1 Mounting of the Mounting Bracket

⚠ CAUTION

- For selecting the appropriate mounting bracket matched to the installation environment, the mounting bracket is not incorporated in this device. Please purchase the optional mounting bracket to fit on the mounting environment.
- Do not apply the load such as forced bending to the cable of this device. Applying improper load could cause the wire breakage.
- The minimum bending radius of the cable is R6mm. Mount the device considering the cable bending radius.

⚠ CAUTION

In case mounting the mounting bracket after mounting the bottom cap cable and the series connection cable, be sure drawing the cable to other side of the hexagon-socket head bolt to prevent the cable from press by the bolt.

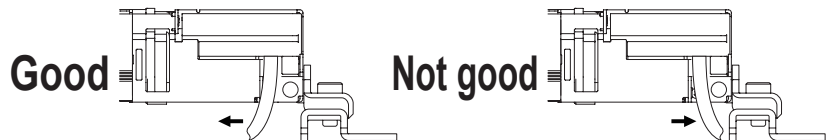

<Reference>

- Mount the emitter and the receiver at the same level and parallel to each other. The effective aperture angle of this device is $\pm 2.5^\circ$ or less for a sensing distance of 3m or more.
- Unless otherwise specified, the following mounting procedure is common for both emitter and receiver. For the preparation of the mounting, prepare the mounting holes on the mounting surface by referring to "6-3 Dimensions."

<Standard mounting bracket (SE9Z-SED-1) (optional)>

1. Loosen the low head cap screw for alignment [M5 (length: 6mm)] of the standard mounting bracket (SE9Z-SED-1).

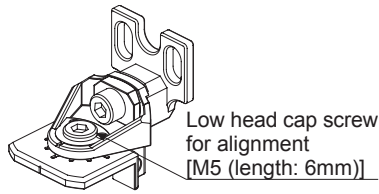

2. As shown in the figure below, adjust the direction of this device and that of installation surface by declining the bracket, and tighten and fix the low head cap screw for alignment. The tightening torque should be 2N·m or less.

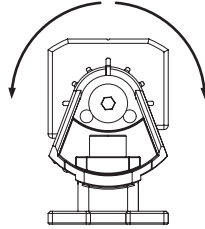

The marks are engraved on the standard mounting bracket so as to adjust the direction of this device by 30 degrees. Set and fix both emitter and receiver using the marks so that they face to each other.

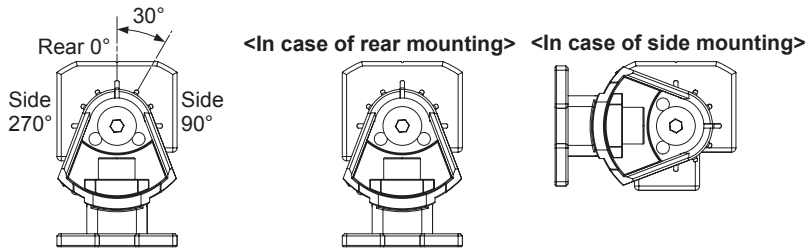

3. Set the device with its mounting hole on the side just overlapping with the mounting hole of the standard mounting bracket, and fix the standard mounting bracket with the accessory hexagon-socket head bolt [M5 (length: 16mm)]. The tightening torque should be 1.2N·m or less.

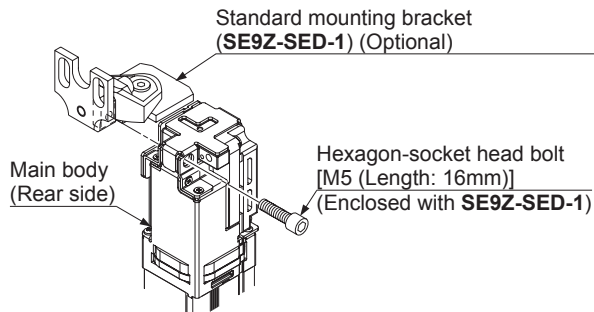

4. Set the standard mounting bracket (**SE9Z-SED-1**) that is ready for setting to the mounting surface using either four hexagon-socket head bolts [M5 (purchase separately)] or two hexagon-socket head bolts [M8 (purchase separately)].

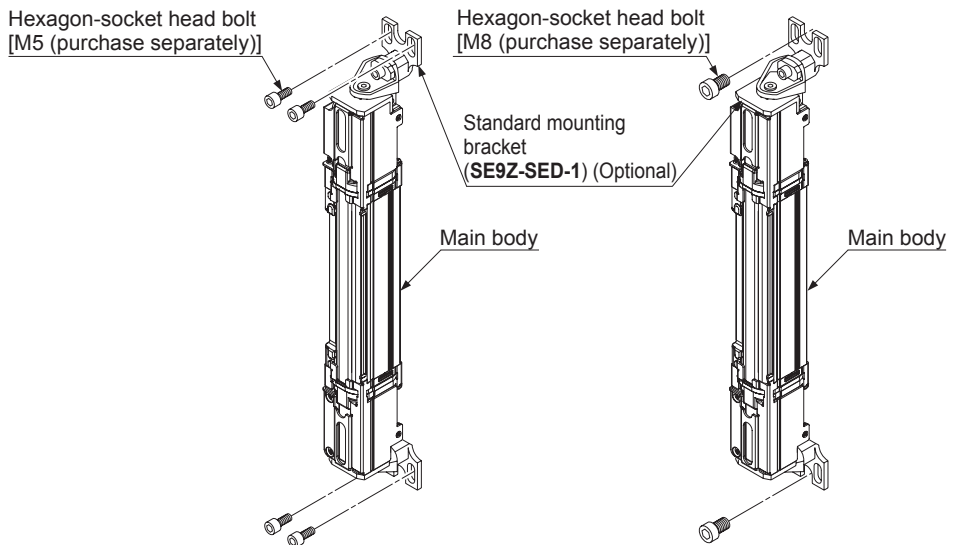

Note: For the models that the intermediate supporting bracket (**SE9Z-SED-2**) is enclosed with, be sure to use the intermediate supporting bracket (**SE9Z-SED-2**). For details, refer to <In case of using intermediate supporting bracket (**SE9Z-SED-2**) (accessory)>.

<Reference>

Mounting method of the M8 360°-rotatable mounting bracket (**SE9Z-SED-1-T**) is the same as the standard mounting bracket (**SE9Z-SED-1**).

<In case of using dead zoneless mounting bracket (SE9Z-SED-3) (optional)>

1. Set the spacer attached to the dead zoneless mounting bracket (SE9Z-SED-3) onto the mounting hole on the side of the top (bottom) end part of this device, and insert the hexagon-socket head bolt [M5 (length: 25mm)] into the hole.

<In case of rear mounting>

<In case of side mounting>

Spacer

(Enclosed with SE9Z-SED-3)

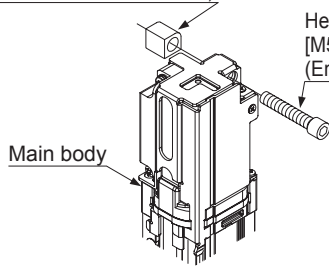

Hexagon-socket head bolt
[M5 (length: 25mm)]
(Enclosed with SE9Z-SED-3)

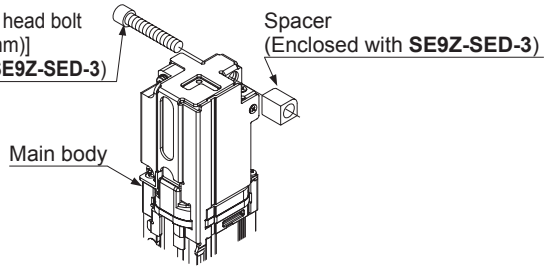

2. Adjust the hexagon-socket head bolt with the status described in Step 1 to the mounting hole of the dead zoneless mounting bracket, and tighten and fix the bracket. The tightening torque should be 1.2N·m or less.

<In case of rear mounting>

<In case of side mounting>

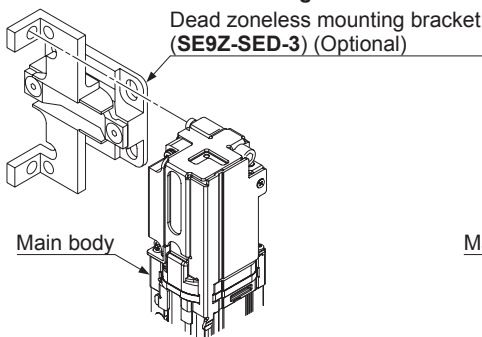

Dead zoneless mounting bracket
(SE9Z-SED-3) (Optional)

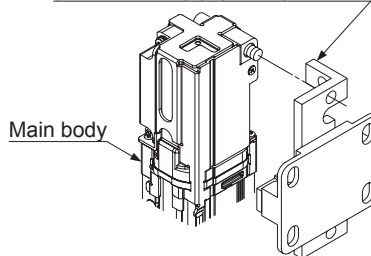

3. Set the dead zoneless mounting bracket that is ready for setting to the mounting surface using four hexagon-socket head bolts [M5 (purchase separately)].

<In case of rear mounting>

<In case of side mounting>

Hexagon-socket head bolt
[M5 (purchase separately)]

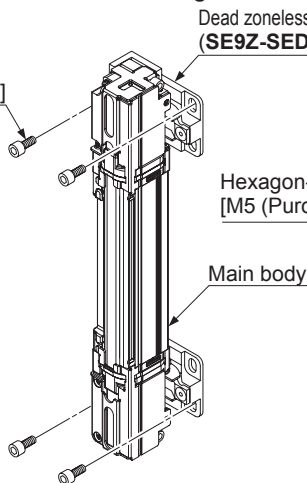

Hexagon-socket head bolt
[M5 (Purchase separately)]

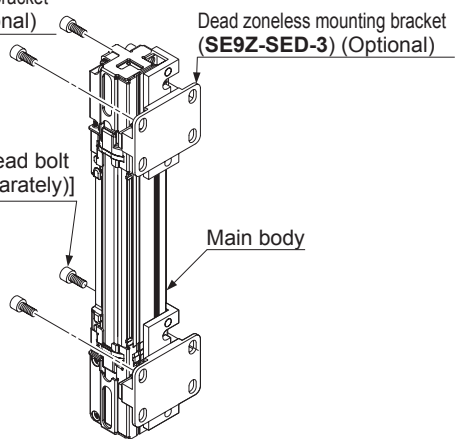

Note: For the models that the intermediate supporting bracket (SE9Z-SED-2) is enclosed with, be sure to use the intermediate supporting bracket (SE9Z-SED-2). For details, refer to **<In case of using intermediate supporting bracket (SE9Z-SED-2) (accessory)>**.

<In case of using intermediate supporting bracket (SE9Z-SED-2) (accessory)>

1. Loosen the hexagon-socket head bolt [M4 (length: 12mm)] screw of the intermediate supporting bracket (SE9Z-SED-2).

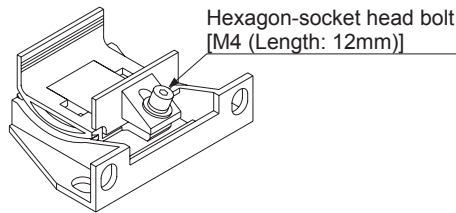

2. Insert the side of this device into the intermediate supporting bracket, and fix it with the hexagon-socket head bolt [M4 (length: 12mm)]. The tightening torque should be 1.2N·m or less.

Refer to “6-3 Dimensions” for the mounting position of the intermediate supporting bracket.

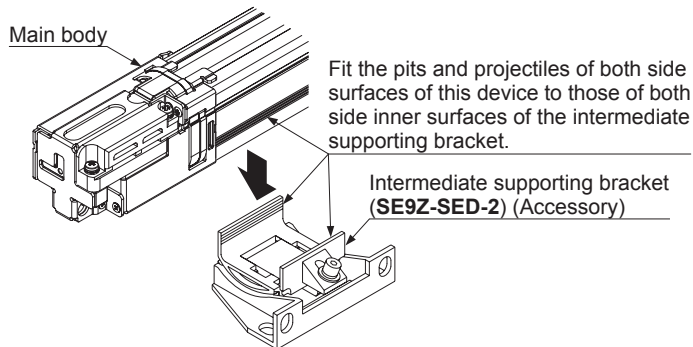

When setting the intermediate supporting bracket on both side surfaces of this device, fit the four pits and projectiles of both side surfaces of the main body to those of both side surfaces (inner surfaces) of the intermediate supporting bracket.

3. After aligning the beam axis, mount the intermediate supporting bracket to the mounting surface using two hexagons-socket head bolts [M5 (purchase separately)]. For the details of beam-axis alignment, refer to “2-6-1 Beam-axis Alignment.”

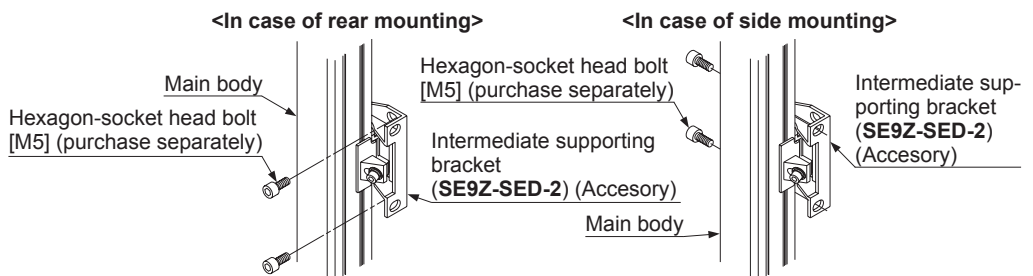

2-4-2 Mounting of the Bottom Cap Cable (Optional)

The cable is not enclosed with this device.

Mount the bottom cap cable (optional) in accordance with the following procedure.

CAUTION

- Do not lose any screws during extension / dismantling.
- The bottom cap cables are distinguished with the color of the cables, the color of the cable for the emitter is gray and that of the receiver is gray (with a black stripe). Connect the cable to emitter and receiver without fail using their colors as the guide.

<Reference>

There are two types of bottom cap cables (8-core type and 12-core type). Select the bottom cap cable as usage.

The length of the bottom cap cable differs depending on the model No.

Type	Model No.	Cable length (m)
8-core Discrete wire type	SE9Z-CCB3	3
	SE9Z-CCB7	7
	SE9Z-CCB10	10
	SE9Z-CCB15	15
12-core Discrete wire type	SE9Z-CCB3-MU	3
	SE9Z-CCB7-MU	7

<Mounting method>

1. Insert the connector of the bottom cap cable (optional) into the connector of this device.
When inserting the connector, fit the cable to the groove of this device.

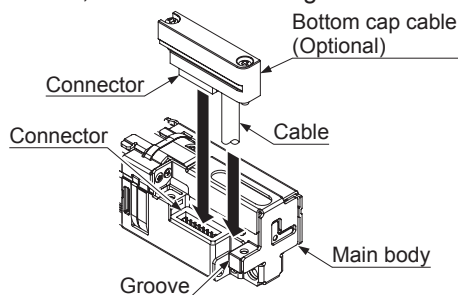

2. Tighten the two M2.6 screws. The tightening torque should be 0.3N·m or less.

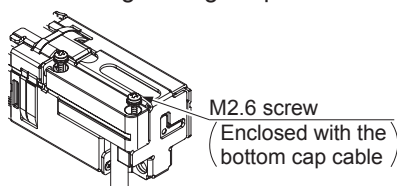

2-4-3 Extension and Dismantling of Sensor (Series Connection)

This section describes the extension method of the series connection using the options. For constructing the series connection, the following procedure is required.

CAUTION

Do not lose any screws during extension / dismantling work. Furthermore, do not mix emitters and receivers to mount in series connection.

<Mounting method of cable for series connection>

Replace the cable for series connection (**SE9Z-CSL05**).

1. Loosen the two M2.6 screws of the end cap on the main sensor (emitter and receiver to which the synchronization line has been connected), and then remove the end cap from the device.

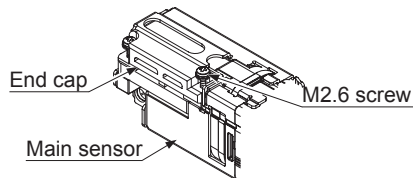

2. Insert the connector of the cable for series connection (**SE9Z-CSL05**) (optional) into the connector. When inserting the connector, fit the cable into the groove of this device.

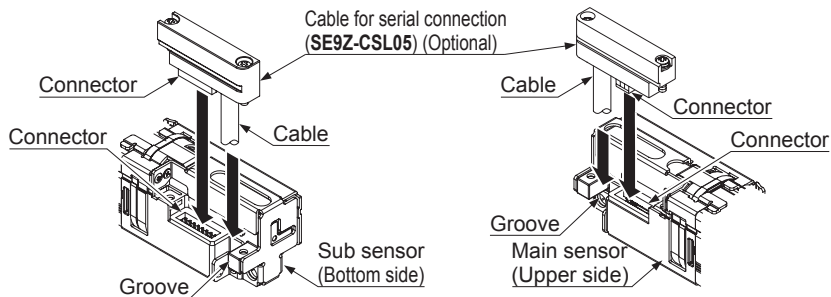

3. Tighten each two M2.6 screws. The tightening torque should be 0.3N·m or less.

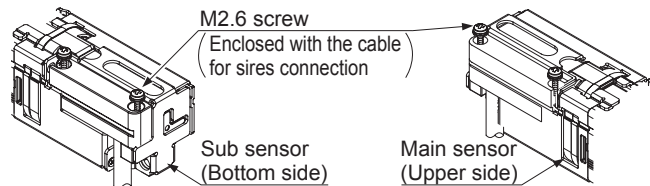

⚠ CAUTION

- Take care that the shape of the connectors for the bottom side and for the end cap side on the cable for series connection (**SE9Z-CSL05**) is different.
- The cable for series connection (**SE9Z-CSL05**) cannot be extended.
- When the cable for series connection (**SE9Z-CSL05**) is inserted to the main sensor, take care of the following. If inserted without care, the connector pins may bend.

1) Do not insert the connector part aslant.

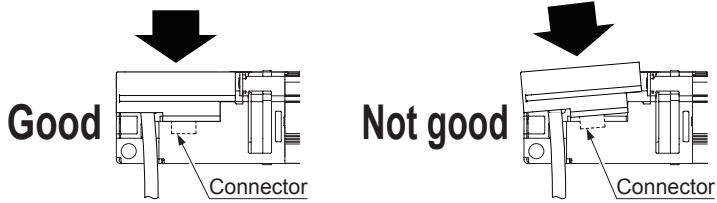

2) Do not pull the cables before tightening the M2.6 screws.



3) Do not insert the connector incorrectly and tighten the M2.6 screws.

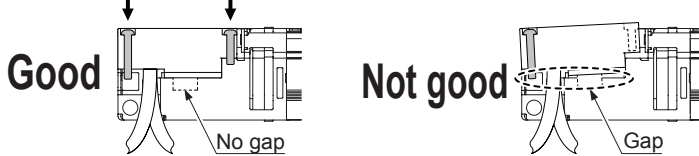

<Reference>

There is no difference in the cable for series connection for the emitter and the receiver.

Model No.	Cable Length (mm)
SE9Z-CSL05	500

<Dismantling the cable for series connection>

1. For dismantling the cable for series connection, follow the above procedure of **<Mounting method of cable for series connection>** in reverse.

2-5 Wiring

WARNING

- Earth the machine or the support where the device is mounted on to frame ground (F.G.). Failure to do so could cause the malfunction of the device by noise, resulting in death or serious injury.
Furthermore, the wiring should be done in a metal box connected to the frame ground (F.G.).
- Take countermeasure against the system to be applied for this device so as not to carry out the dangerous performance caused by the earth failure. Failure to do so could cause invalid for the system stop, resulting in death or serious injury.
- In order that the output is not turned ON due to earth fault of control output (OSSD 1 / 2) wires, be sure to ground to 0V side (PNP output) / +24V side (NPN output).

CAUTION

Make sure to insulate the ends of the unused lead wires.

<Reference>

Use a safety relay unit or an equivalent control circuit in safety for FSD.

2-5-1 Power Supply Unit

WARNING

Wire correctly using a power supply unit which conforms to the laws and standards of the region where this device is to be used. If the power supply unit is non-conforming or the wiring is improper, it can cause damage or malfunction of this device.

<Reference>

A specialist who has the required electrical knowledge should perform the wiring.

The power supply unit must satisfy the conditions given below.

- 1) Power supply unit authorized in the region where this device is to be used.
- 2) Power supply unit SELV (safety extra low voltage) / PELV (protected extra low voltage) conforming to EMC Directive and Low-voltage Directive (only for requiring CE marking conformation).
- 3) Power supply unit conforming to the Low-voltage Directive and with an output of 100VA or less.
- 4) The frame ground (F.G.) terminal must be connected to ground when using a commercially available switching regulator.
- 5) Power supply unit with an output holding time of 20ms or more.
- 6) In case a surge is generated, take countermeasures such as connecting a surge absorber to the origin of the surge.
- 7) Power supply unit corresponding to CLASS 2 (only for requiring UL Listing Mark / C-UL US Listing Mark conformation).

2-5-2 I/O Circuit Diagrams and Output Waveform

<In case of using I/O circuit for PNP output>

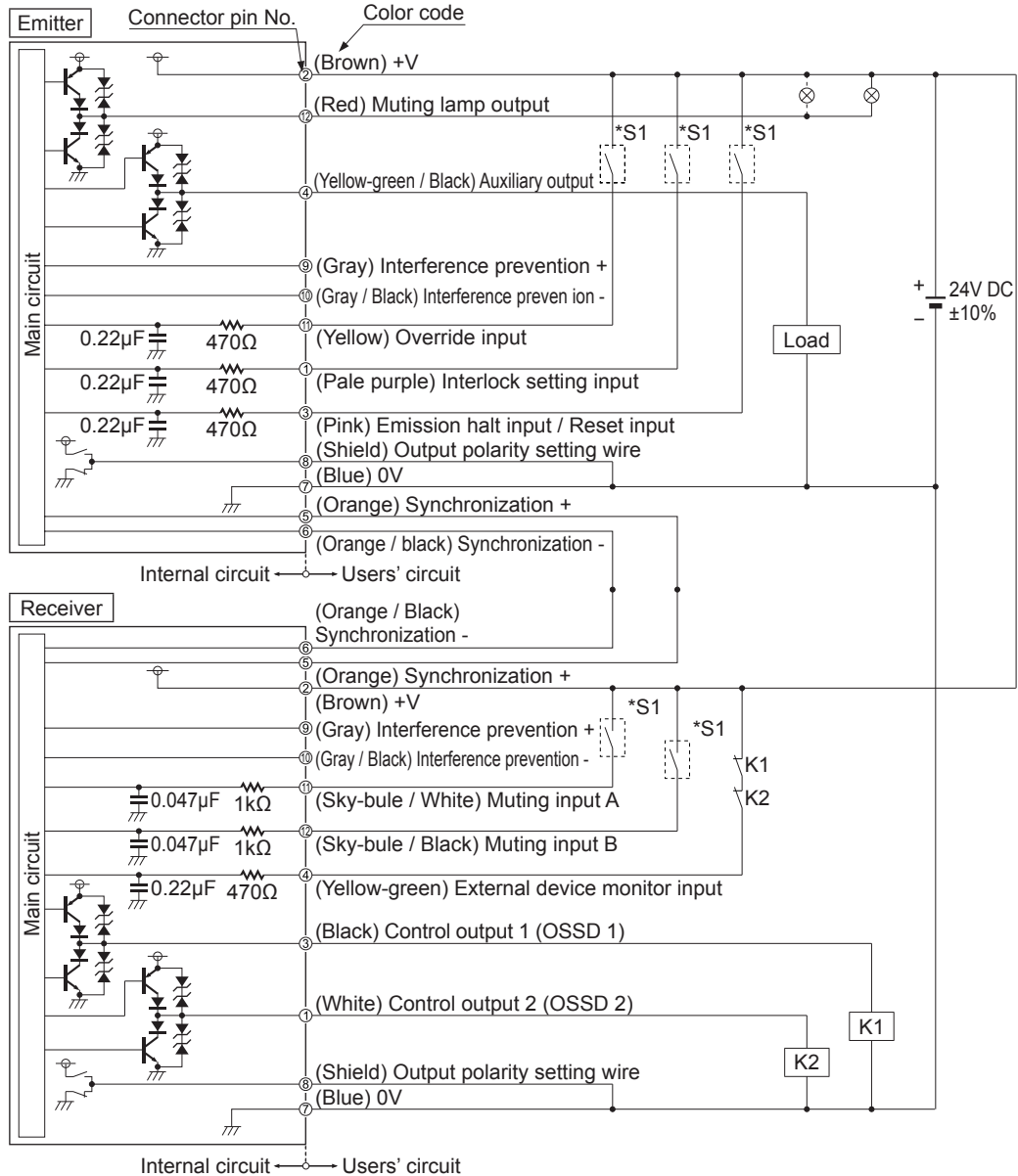

*S1

Switch S1

- Emission halt input / Reset input

For manual reset: V_s to $V_s - 2.5V$ (sink current 5mA or less) : Emission halt (Note 1), Open: Emission

For auto-reset: V_s to $V_s - 2.5V$ (sink current 5mA or less) : Emission (Note 1), Open: Emission halt

- Interlock setting input, Override input, Muting input A / B, External device monitor input

V_s to $V_s - 2.5V$ (sink current 5mA or less): Valid (Note 1), Open: Invalid

Notes: 1) V_s is the applying supply voltage.

2) The circuit diagram shown above is for 12-core cable to be used. For 8-core cable, red, yellow, gray, gray / black, sky-blue / white, sky-blue / black, there is no lead wire.

<Reference>

K1, K2: External device (Forced guided relay or magnetic contactor)

<In case of using I/O circuit for NPN output>

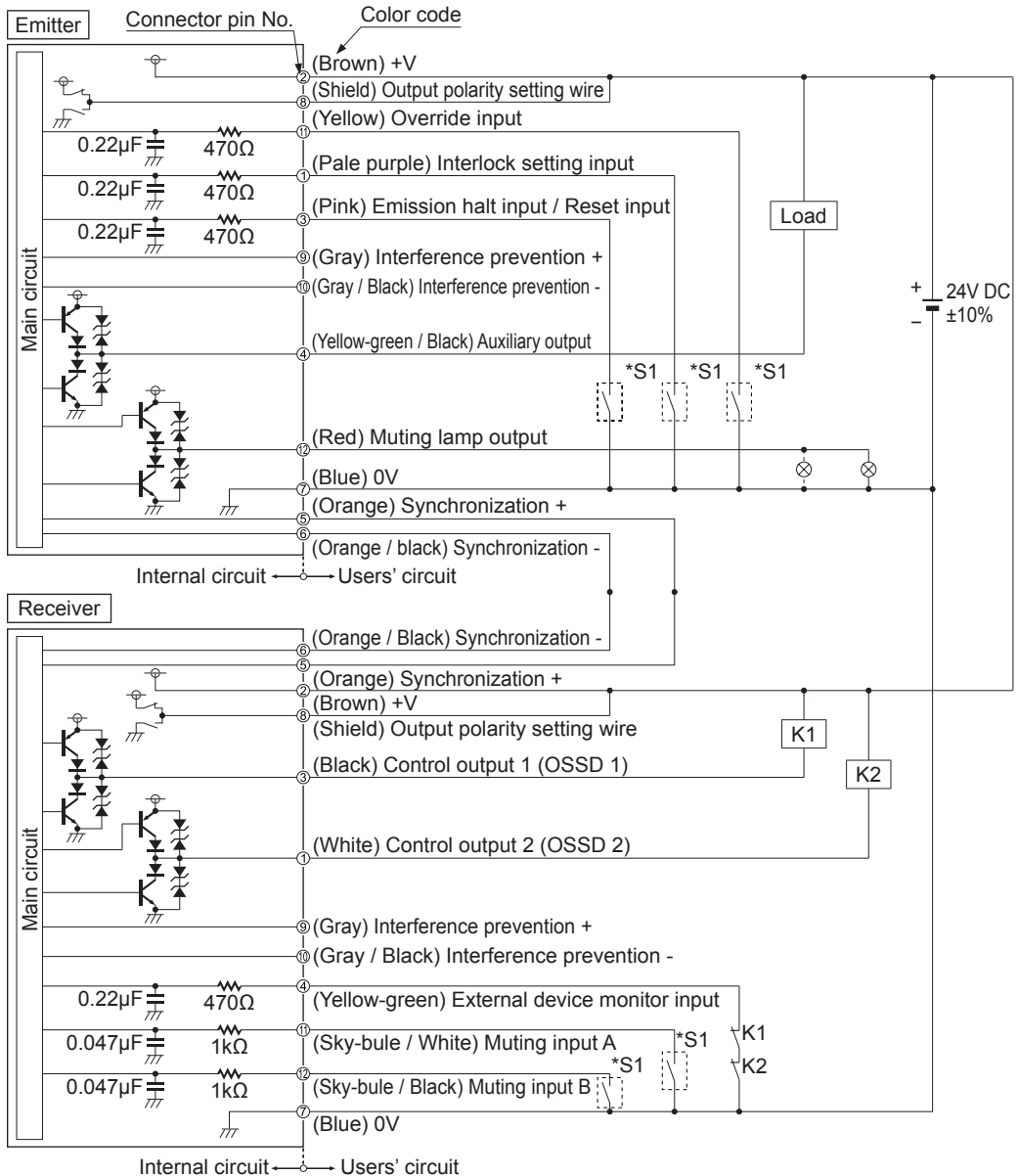

*S1

- Switch S1
- Emission halt input / Reset input
For manual reset: 0 to +1.5V (source current 5mA or less): Emission halt, Open: Emission
For auto-reset: 0 to +1.5V (source current 5mA or less): Emission, Open: Emission halt
 - Interlock setting input, Override input, Muting input A / B, External device monitor input
0 to +1.5V (source current: 5mA or less): Valid, Open: Invalid

Note: The circuit diagram shown above is for 12-core cable to be used. For 8-core cable, red, yellow, gray, gray / black, sky-blue / white, sky-blue / black, there is no lead wire.

<Reference>

K1, K2: External device (Forced guided relay or magnetic contactor)

<Output waveform [control output (OSSD 1 / 2) ON]>

Since the receiver performs the self-diagnosis of the output circuit when the device is in light receiving status (ON status), the output transistor becomes OFF status periodically. (Refer to the figure below.) When the OFF signal is fed back, the receiver judges the output circuit as normal. When the OFF signal is not fed back, the receiver judges either the output circuit or wiring as error, and the control output (OSSD 1 / 2) maintains OFF status.

CAUTION

Perform the wiring with paying attention to the input response time of the machine to be connected to this device, since the OFF signal of this device might cause malfunction.

<Timing chart>

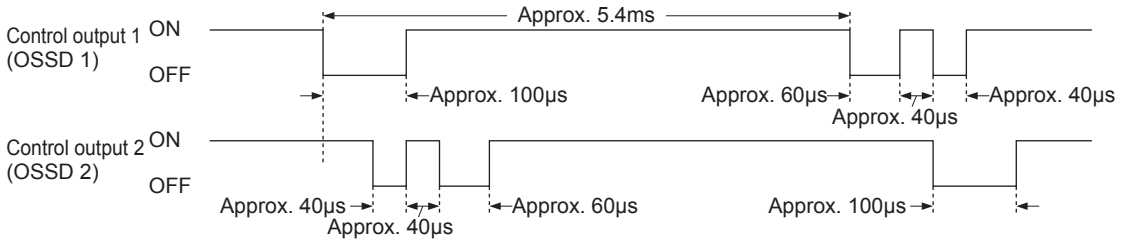

2-5-3 Wiring · Connecting Procedure and Connector Pin Arrangement

WARNING

- In case the muting lamp is used, a total length should be 40m or less (for each emitter / receiver).
- When the synchronization + wire (orange) and synchronization - wire (orange / black) is extended with a cable other than exclusive cable, use a 0.2mm² or more shielded twisted pair cable.

Bottom cap cable / discrete wire

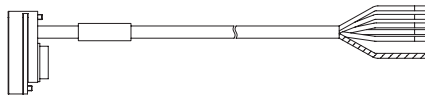

<8-core cable (SE9Z-CC□)>

	Cable color	Connector Pin No.	Color code	Description
Emitter	Gray	1	Pale purple	Interlock setting input
		2	Brown	+V
		3	Pink	Emission halt input / Reset input
		4	Yellow-green / Black	Auxiliary output
		5	Orange	Synchronization +
		6	Orange / Black	Synchronization -
		7	Blue	0V
		8	(Shield)	Output polarity setting wire
Receiver	Gray (with black stripe)	1	White	Control output 2 (OSSD 2)
		2	Brown	+V
		3	Black	Control output 1 (OSSD 1)
		4	Yellow-green	External device monitor input
		5	Orange	Synchronization +
		6	Orange / Black	Synchronization -
		7	Blue	0V
		8	(Shield)	Output polarity setting wire

<12-core cable (SE9Z-CC□-MU)>

	Cable color	Connector Pin No..	Color code	Description
Emitter	Gray	1	Pale purple	Interlock setting input
		2	Brown	+V
		3	Pink	Emission halt input / Reset input
		4	Yellow-green / Black	Auxiliary output
		5	Orange	Synchronization +
		6	Orange / Black	Synchronization -
		7	Blue	0V
		8	(Shield)	Output polarity setting wire
		9	Gray	Interference prevention +
		10	Gray / Black	Interference prevention -
		11	Yellow	Override input
		12	Red	Muting lamp output
Receiver	Gray (with black stripe)	1	White	Control output 2 (OSSD 2)
		2	Brown	+V
		3	Black	Control output 1 (OSSD 1)
		4	Yellow-green	External device monitor input
		5	Orange	Synchronization +
		6	Orange / Black	Synchronization -
		7	Blue	0V
		8	(Shield)	Output polarity setting wire
		9	Gray	Interference prevention +
		10	Gray / Black	Interference prevention -
		11	Sky-blue / White	Muting input A
		12	Sky-blue / Black	Muting input B

<Reference>

- For details of the bottom cap cable, refer to "6-2 Options."

2-5-4 Basic Wiring

This is the general configuration using one set of the emitter and receiver facing each other. The control output (OSSD 1 / 2) turns OFF if the light is blocked, while it automatically turns ON if it receives the light.

The auxiliary output is used to invalid the external device monitor function. At this time, set the auxiliary output with “negative logic of the control output” (factory setting). The auxiliary output cannot be connected to external devices.

<For PNP output>

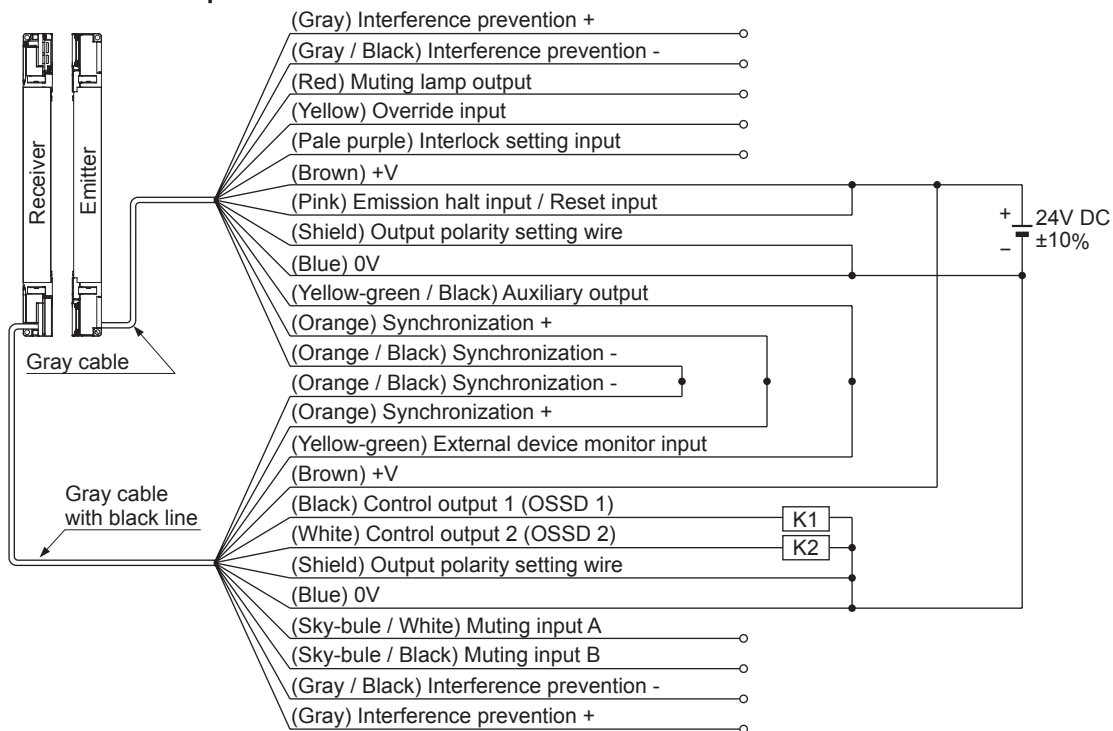

Interlock function	Invalid (Auto-reset)
External device monitor function	Invalid
Auxiliary output	Cannot be used

Note: The circuit diagram shown above is for 12-core cable to be used. For 8-core cable, red, yellow, gray, gray / black, sky-blue / white, sky-blue / black, there is no lead wire.

<For NPN output>

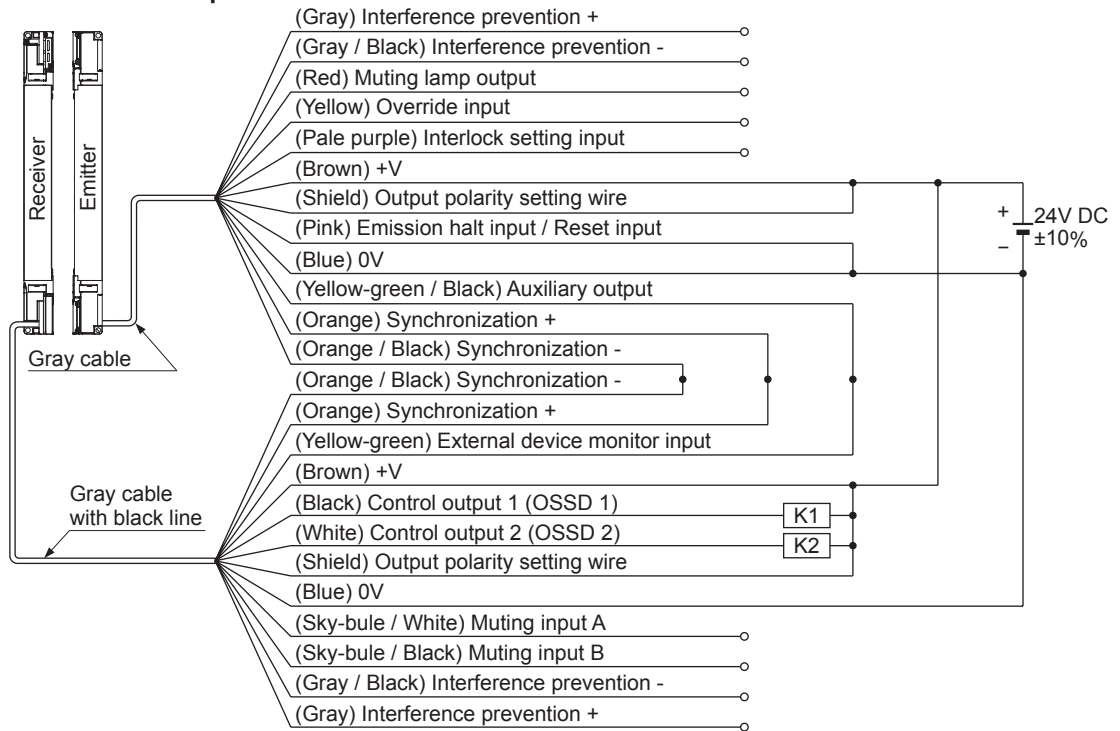

Interlock function	Invalid (Auto-reset)
External device monitor function	Invalid
Auxiliary output	Cannot be used

Note: The circuit diagram shown above is for 12-core cable to be used. For 8-core cable, red, yellow, gray, gray / black, sky-blue / white, sky-blue / black, there is no lead wire.

2-5-5 Wiring for Manual Reset (Interlock is Valid) (Wiring Example of the Control Category 4)

This is the general configuration using one set of the emitter and receiver facing each other. The control output (OSSD 1 / 2) turns OFF if the light is blocked.

<For PNP output>

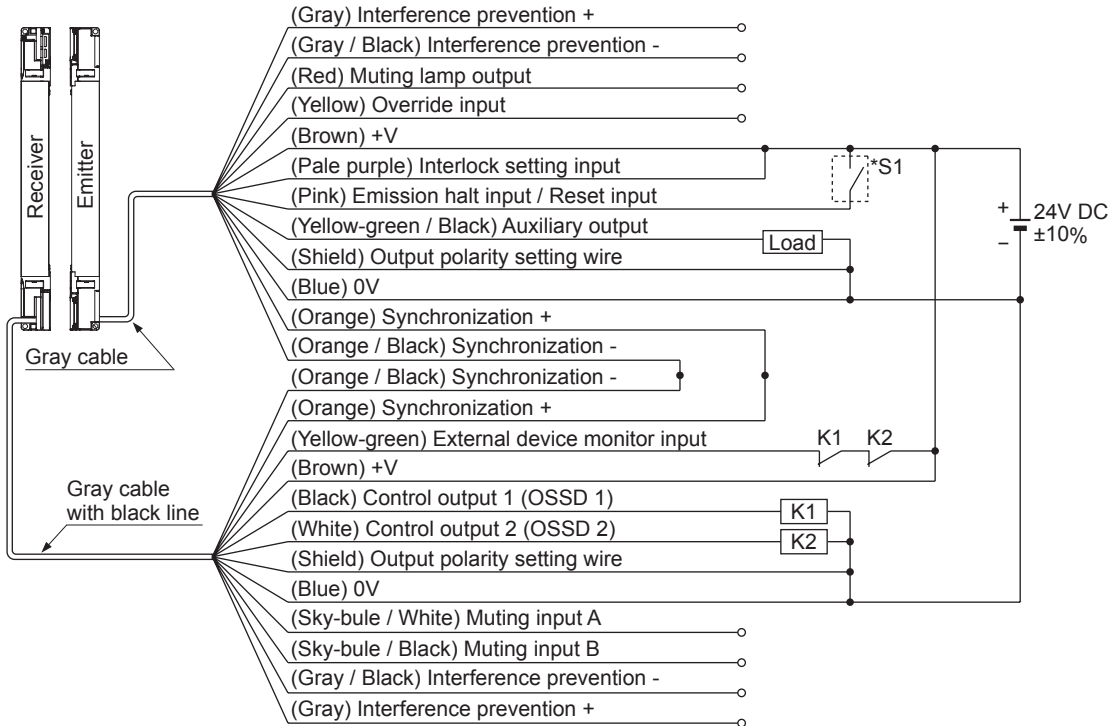

Interlock function	Valid (Manual reset)
External device monitor function	Valid
Auxiliary output	Can be used

The device output is selected depending on the connecting state of the output polarity setting wire (shield). Incorrect wiring may cause the lockout state.

* Symbols

Switch S1
 V_s to $V_s - 2.5V$ (sink current 5mA or less): Emission halt (Note 1), Open: Emission
 K1, K2: External device (Forced guided relay or magnetic contactor)

Notes: 1) V_s is the applying supply voltage.

2) The circuit diagram shown above is for 12-core cable to be used. For 8-core cable, red, yellow, gray, gray / black, sky-blue / white, sky-blue / black, there is no lead wire.

3) For resetting, refer to "3-2 Interlock Function."

<For NPN output>

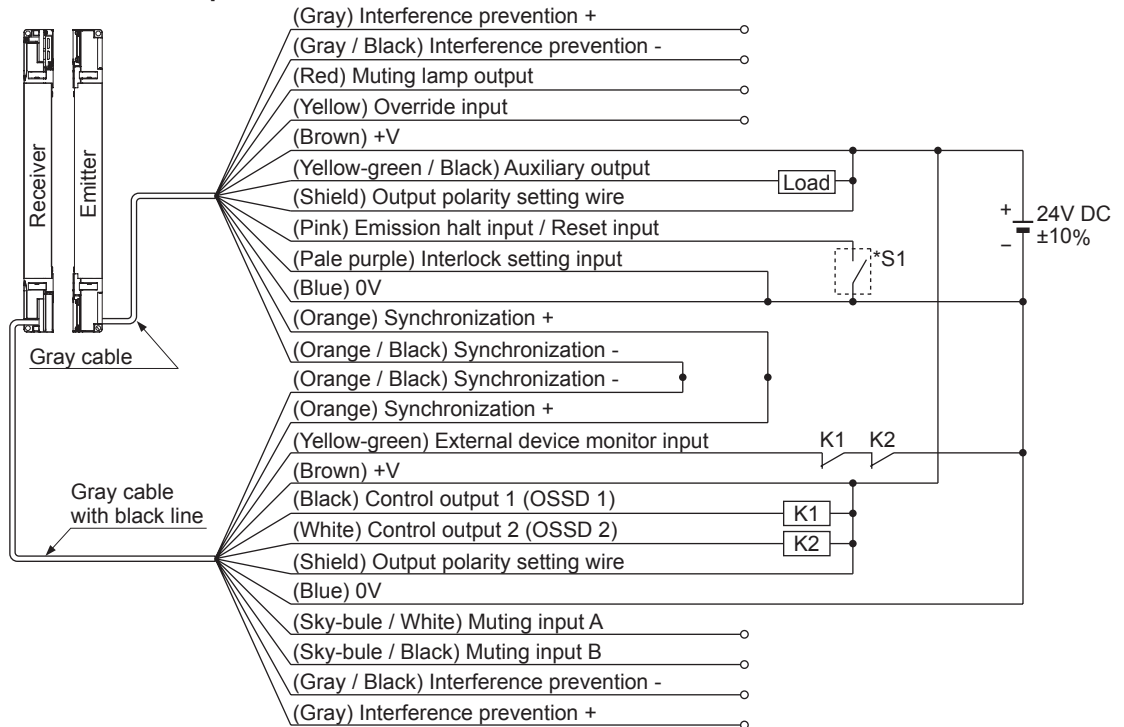

Interlock function	Valid (Manual reset)
External device monitor function	Valid
Auxiliary output	Can be used

The device output is selected depending on the connecting state of the output polarity setting wire (shield). Incorrect wiring may cause the lockout state.

* Symbols

Switch S1
 0 to +1.5V (source current 5mA or less): Emission halt, Open: Emission
 K1, K2: External device (Forced guided relay or magnetic contactor)

- Notes: 1) The circuit diagram shown above is for 12-core cable to be used. For 8-core cable, red, yellow, gray, gray / black, sky-blue / white, sky-blue / black, there is no lead wire.
 2) For resetting, refer to "3-2 Interlock Function."

2-5-6 Series Connection (Wiring Example of the Control Category 4)

[Connectable up to 3 sets of the devices (however, 192 beam channels max.)]

This is the configuration for connecting multiple sets of emitters and receivers facing each other in series. It is used when the dangerous part can be entered from two or more directions. If any of the sets is in light blocked status, the control output (OSSD 1 / 2) turns OFF.

⚠ WARNING

For series connection, connect the emitter and emitter, receiver and receiver respectively using the exclusive cable (**SE9Z-CSL05**) for series connection. Wrong connection could generate the non-sensing area, resulting in death or serious injury.

<For PNP output>

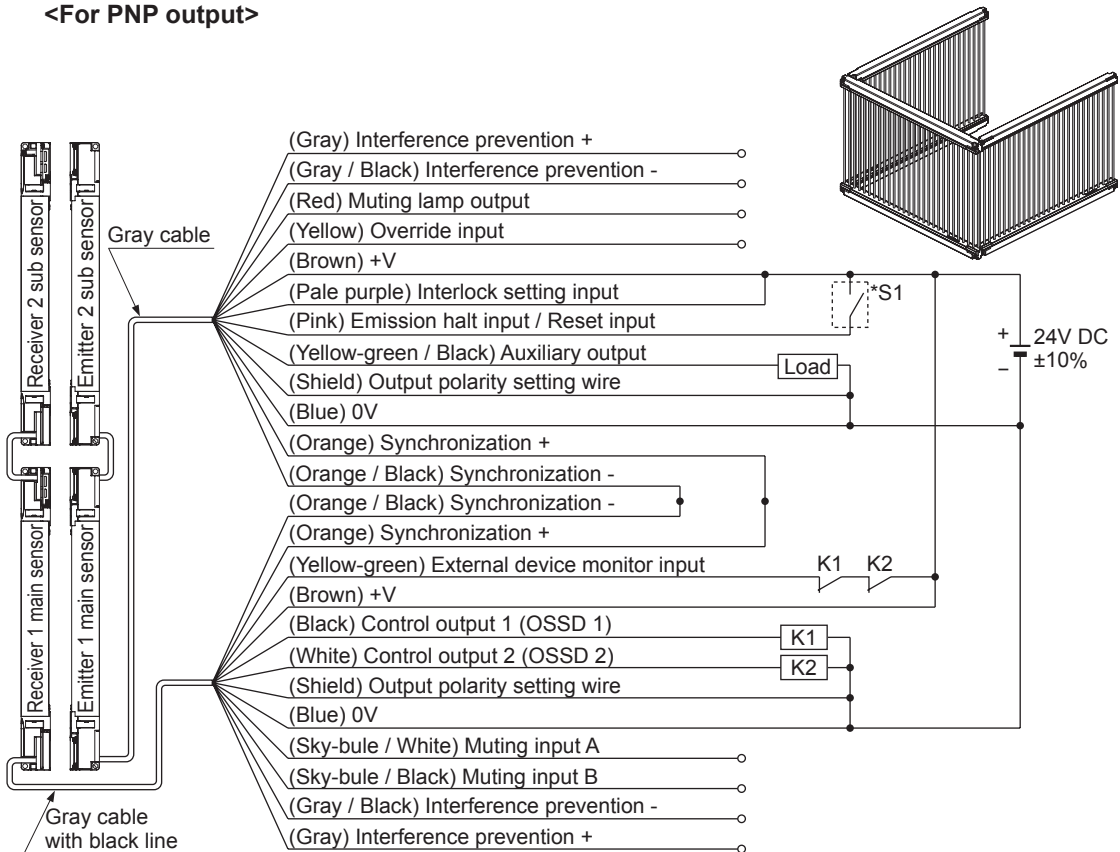

Interlock function	Valid (Manual reset)
External device monitor function	Valid
Auxiliary output	Can be used

The device output is selected depending on the connecting state of the output polarity setting wire (shield). Incorrect wiring may cause the lockout state.

* Symbols

Switch S1
Vs to Vs - 2.5V (sink current 5mA or less): Emission halt (Note 1), Open: Emission
K1, K2: External device (Forced guided relay or magnetic contactor)

Notes: 1) Vs is the applying supply voltage.

2) The circuit diagram shown above is for 12-core cable to be used. For 8-core cable, red, yellow, gray, gray / black, sky-blue / white, sky-blue / black, there is no lead wire.

3) For resetting, refer to "3-2 Interlock Function."

<For NPN output>

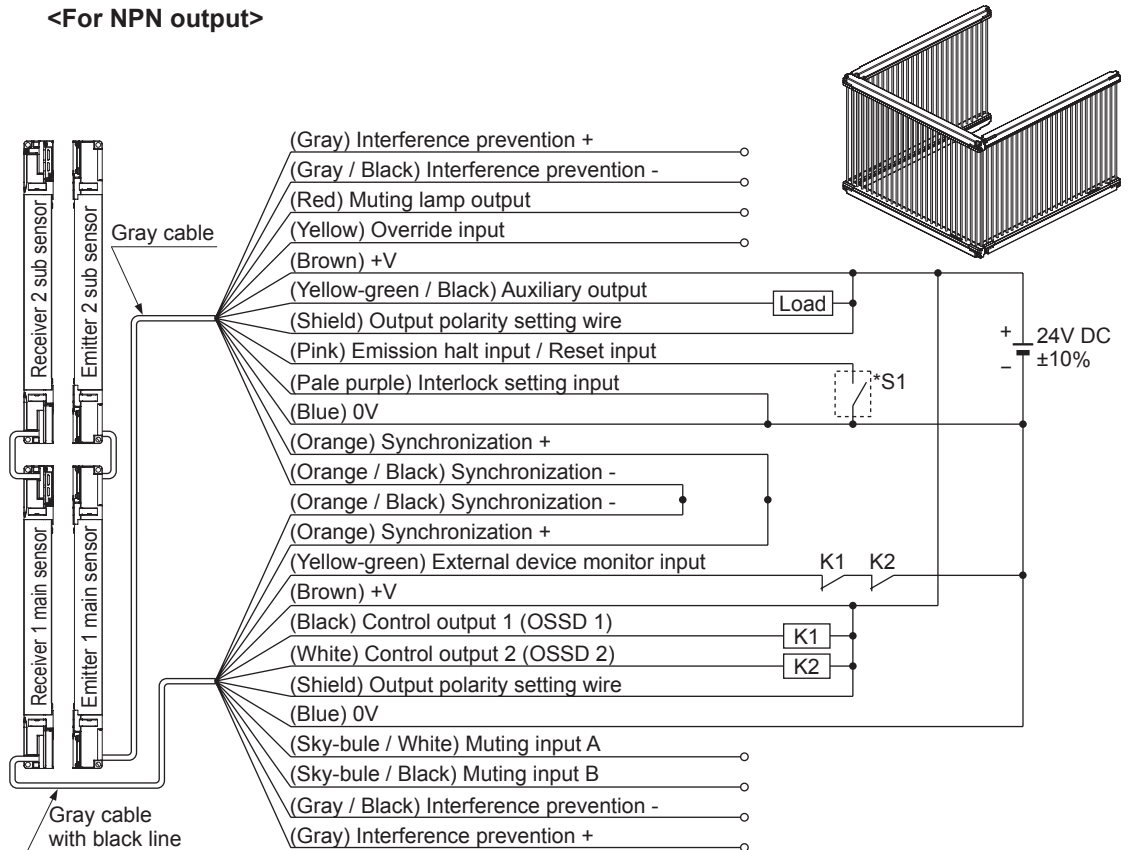

Interlock function	Valid (Manual reset)
External device monitor function	Valid
Auxiliary output	Can be used

The device output is selected depending on the connecting state of the output polarity setting wire (shield) wire. Incorrect wiring may cause the lockout state.

* Symbols

Switch S1
 0 to +1.5V (source current 5mA or less): Emission halt, Open: Emission
 K1, K2: External device (Forced guided relay or magnetic contactor)

- Notes: 1) The circuit diagram shown above is for 12-core cable to be used. For 8-core cable, red, yellow, gray, gray / black, sky-blue / white, sky-blue / black, there is no lead wire.
 2) For resetting, refer to "3-2 Interlock Function."

2-5-7 Parallel Connection (Wiring Example of the Control Category 4)

This is the configuration for connecting multiple sets of emitter and receiver facing each other in parallel. It is used when there are two dangerous parts and each dangerous part can be entered from only one direction. By connecting the interference prevention line, up to three sets of the devices can be connected. For the control output (OSSD 1 / 2), only the set of which light is blocked turns OFF.



For parallel connection, connect the one receiver to the other connection using the interference prevention line as shown in the figure on the next page. Wrong connection could generate the non-sensing area, resulting in death or serious injury.

<For PNP output>

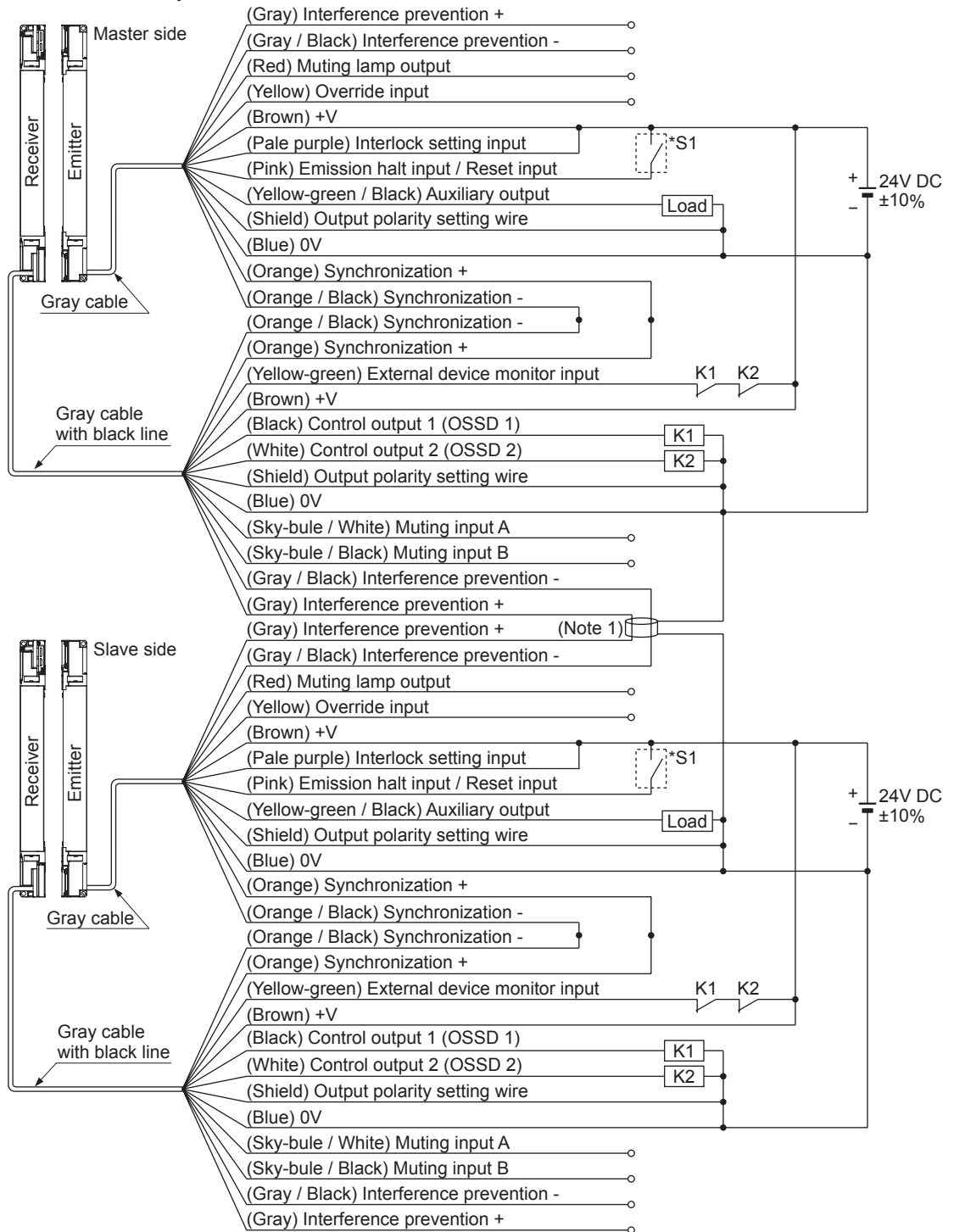

Interlock function	Valid (Manual reset)
External device monitor function	Valid
Auxiliary output	Can be used

The device output is selected depending on the connecting state of the output polarity setting wire (shield).
Incorrect wiring may cause the lockout state.

* Symbols

Switch S1
Vs to Vs - 2.5V (sink current 5mA or less): Emission halt (Note 2), Open: Emission
K1, K2: External device (Forced guided relay or magnetic contactor)

- Notes: 1) If the interference prevention wire is extended, use a 0.2mm² or more, shielded twisted pair cable.
2) Vs is the applying supply voltage.
3) For resetting, refer to "**3-2 Interlock Function.**"

<For NPN output>

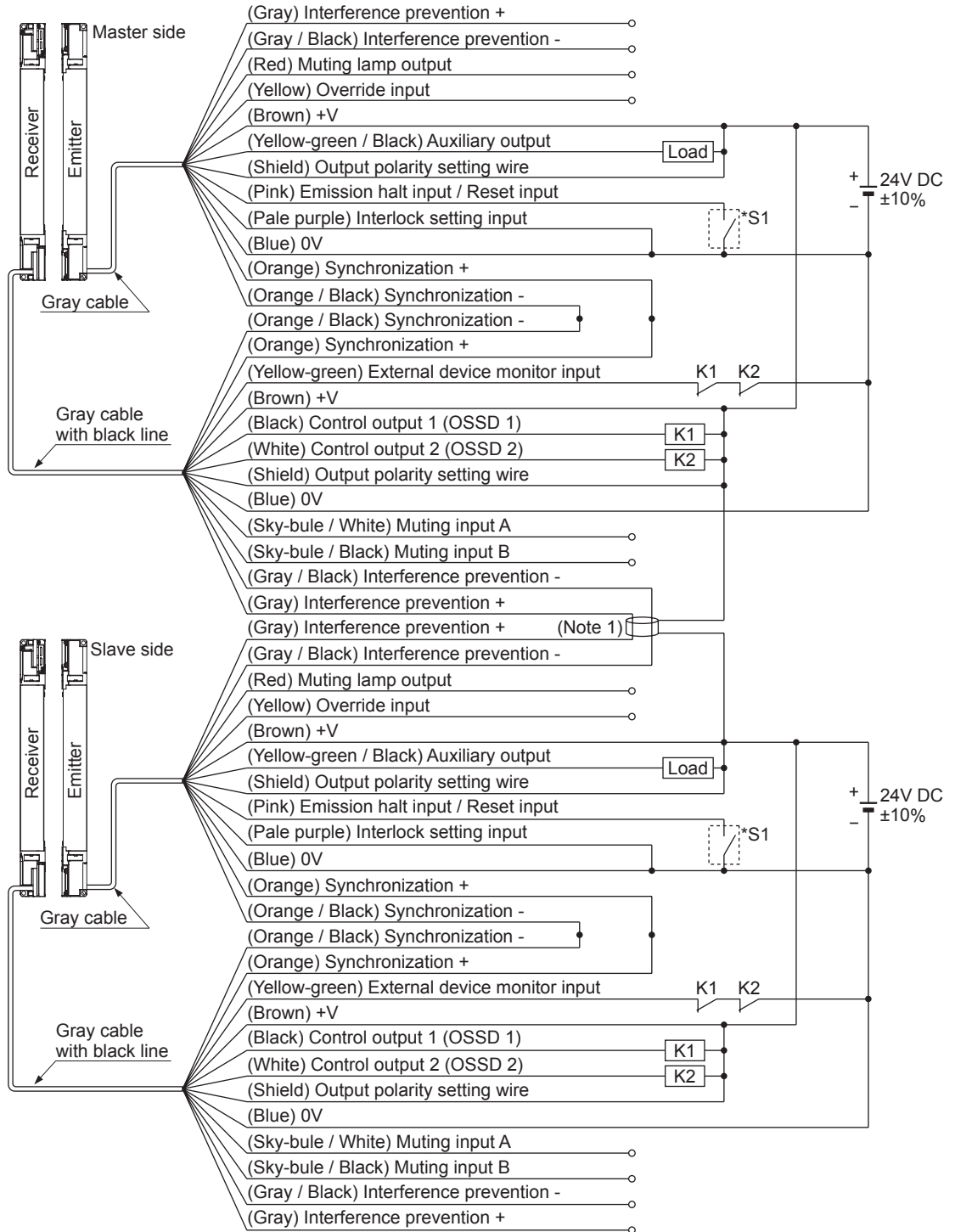

Interlock function	Valid (Manual reset)
External device monitor function	Valid
Auxiliary output	Can be used

The device output is selected depending on the connecting state of the output polarity setting wire (shield).
Incorrect wiring may cause the lockout state.

* Symbols

Switch S1
0 to +1.5V (source current 5mA or less): Emission halt, Open: Emission
K1, K2: External device (Forced guided relay or magnetic contactor)

Notes: 1) If the interference prevention wire is extended, use a 0.2mm² or more, shielded twisted pair cable.
2) For resetting, refer to “**3-2 Interlock Function.**”

2-5-8 Series and Parallel Mixed Connection (Wiring Example of the Control Category 4)

This is the configuration for connecting multiple sets of emitter and receiver facing each other in mixed series and parallel combination. It is used when there are two or more dangerous parts that can be entered from two or more directions. Up to three sets of the devices in total of the series connection and parallel connection can be connected in combination. However, the total number of beam channels available is 192. In case of series connection, if any of the sets is in light blocked status, the control output (OSSD 1 / 2) turns OFF. In case of parallel connection, for the control output (OSSD 1 / 2), only the set of which light is blocked turns OFF.

WARNING

- For series connection, connect the emitter and emitter, receiver and receiver respectively using the exclusive cable (**SE9Z-CSL05**) for series connection as shown in the figure on the next page. Wrong connection could generate the non-sensing area, resulting in death or serious injury.
- For parallel connection, connect the one receiver to the other connection using the interference prevention line as shown in the figure on the next page. Wrong connection could generate the non-sensing area, resulting in death or serious injury

<For PNP output>

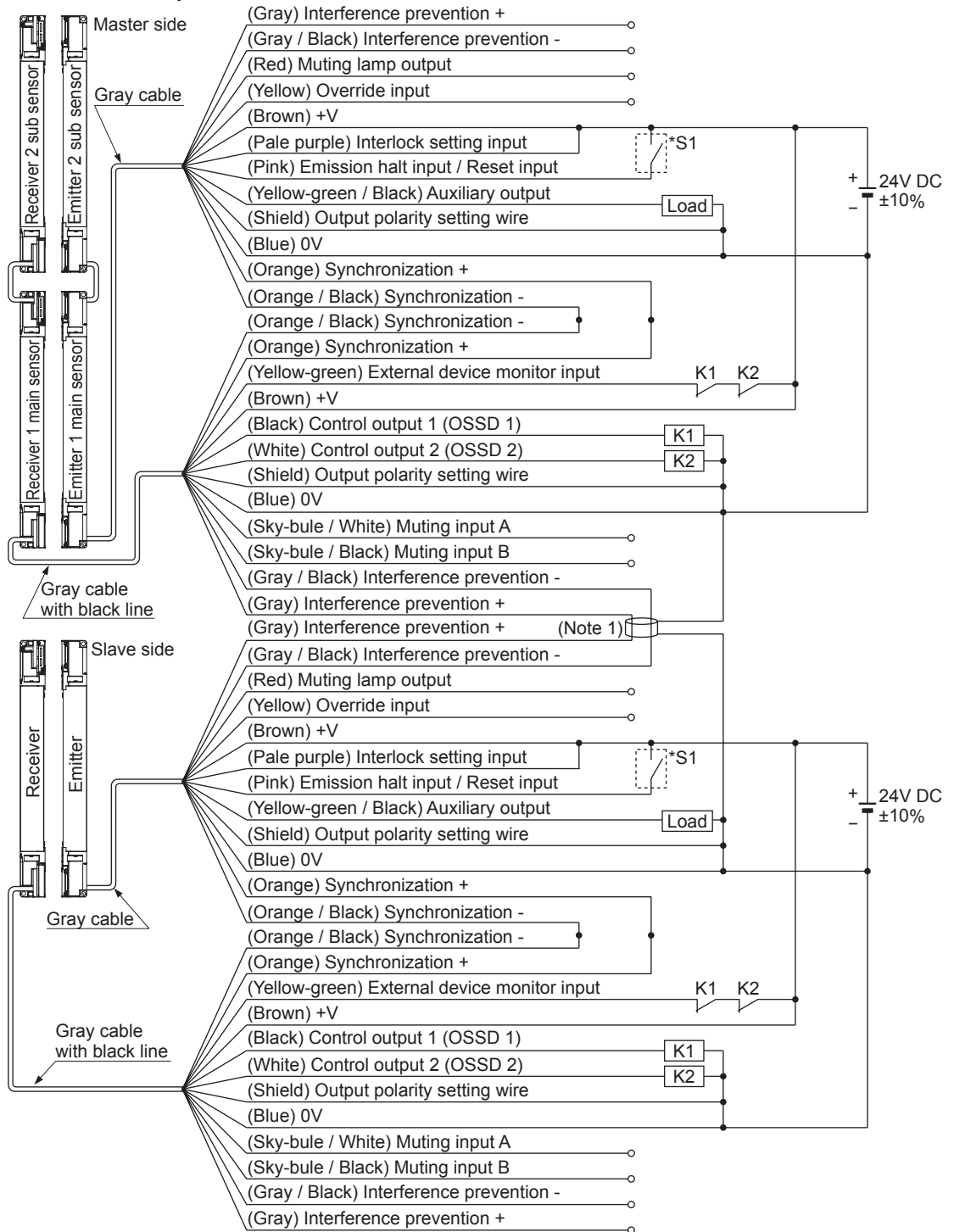

Interlock function	Valid (Manual reset)
External device monitor function	Valid
Auxiliary output	Can be used

The device output is selected depending on the connecting state of the output polarity setting wire (shield).
Incorrect wiring may cause the lockout state.

* Symbols

Switch S1
Vs to Vs - 2.5V (sink current 5mA or less): Emission halt (Note 2), Open: Emission
K1, K2: External device (Forced guided relay or magnetic contactor)

- Notes: 1) If the interference prevention wire is extended, use a 0.2mm² or more, shielded twisted pair cable.
2) Vs is the applying supply voltage.
3) For resetting, refer to "**3-2 Interlock Function.**"

<For NPN output>

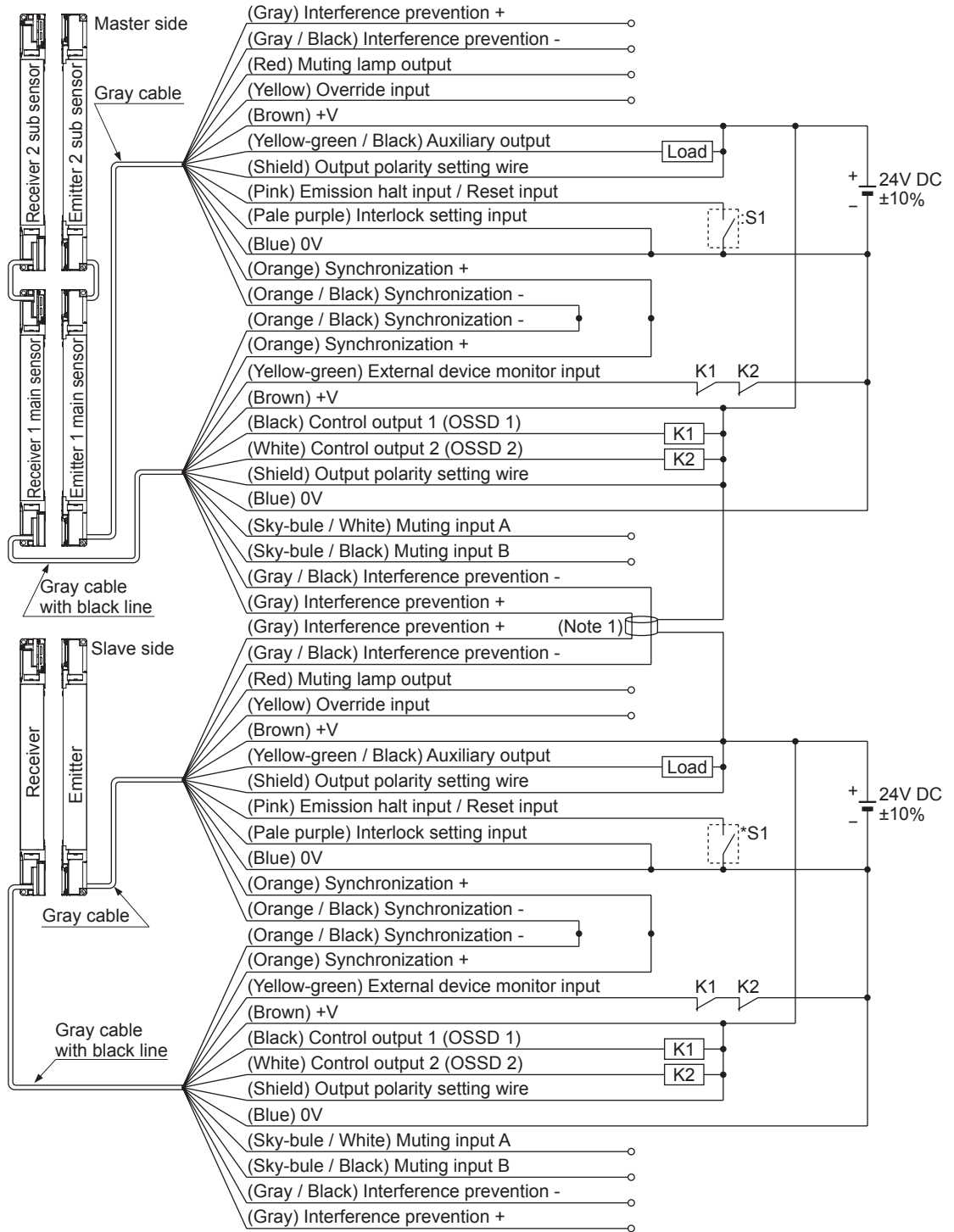

Interlock function	Valid (Manual reset)
External device monitor function	Valid
Auxiliary output	Can be used

The device output is selected depending on the connecting state of the output polarity setting wire (shield).
Incorrect wiring may cause the lockout state.

* Symbols

Switch S1
0 to +1.5V (source current 5mA or less): Emission halt, Open: Emission
K1, K2: External device (Forced guided relay or magnetic contactor)

Notes: 1) If the interference prevention wire is extended, use a 0.2mm² or more, shielded twisted pair cable.
2) For resetting, refer to “**3-2 Interlock Function.**”

2-5-9 Wiring for Auto-reset (Interlock is Invalid) (Wiring Example of the Control Category 4)

<For PNP output>

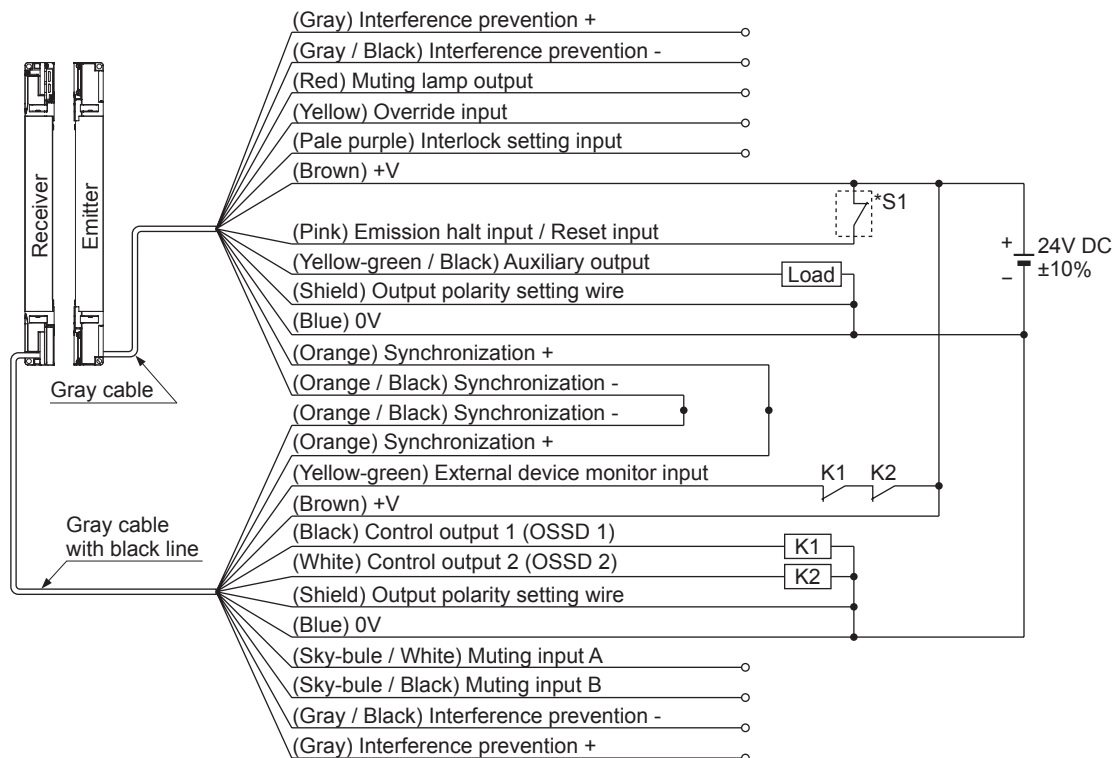

Interlock function	Invalid (Auto-reset)
External device monitor function	Valid
Auxiliary output	Can be used

The device output is selected depending on the connecting state of the output polarity setting wire (shield). Incorrect wiring may cause the lockout state.

* Symbols

Switch S1
 V_s to $V_s - 2.5V$ (sink current 5mA or less): Emission (Note 1), Open: Emission halt
 K1, K2: External device (Forced guided relay or magnetic contactor)

Notes: 1) V_s is the applying supply voltage.

2) The circuit diagram shown above is for 12-core cable to be used. For 8-core cable, red, yellow, gray, gray / black, sky-blue / white, sky-blue / black, there is no lead wire.

3) For resetting, refer to "3-2 Interlock Function."

<For NPN output>

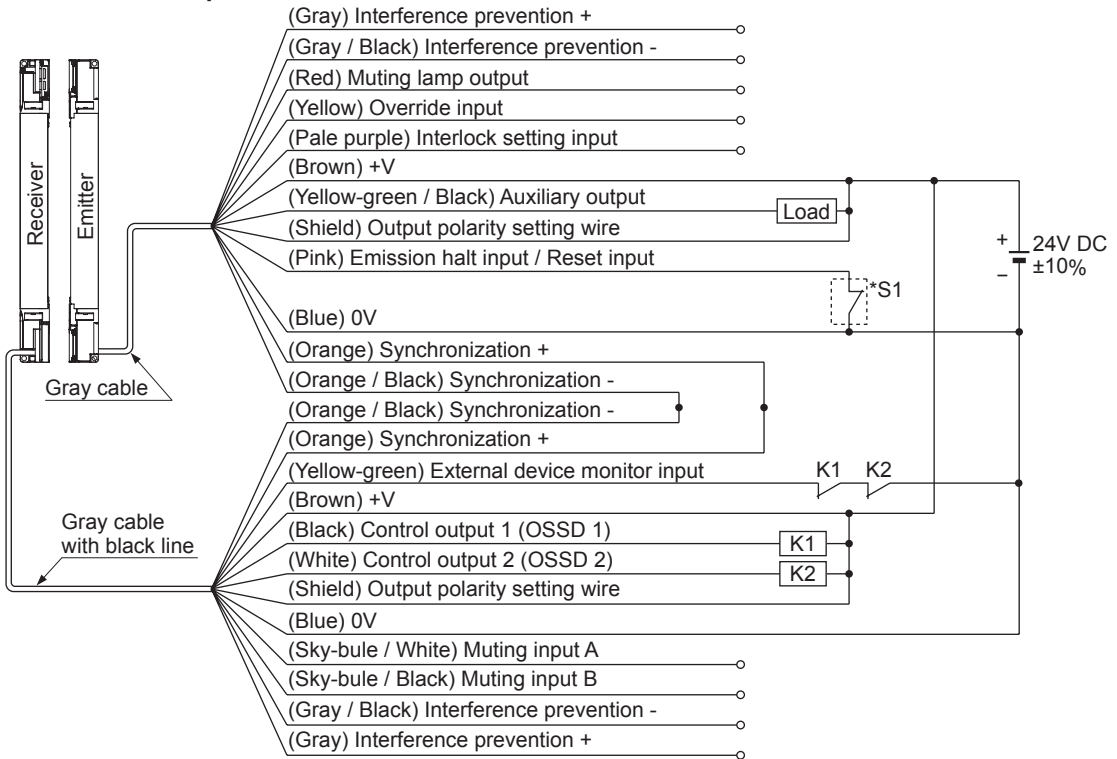

Interlock function	Invalid (Auto-reset)
External device monitor function	Valid
Auxiliary output	Can be used

The device output is selected depending on the connecting state of the output polarity setting wire (shield). Incorrect wiring may cause the lockout state.

* Symbols

Switch S1
 0 to +1.5V (source current 5mA or less): Emission, Open: Emission halt
 K1, K2: External device (Forced guided relay or magnetic contactor)

- Notes: 1) The circuit diagram shown above is for 12-core cable to be used. For 8-core cable, red, yellow, gray, gray / black, sky-blue / white, sky-blue / black, there is no lead wire.
 2) For resetting, refer to "3-2 Interlock Function."

2-5-10 Wiring Configuration for Invalid External Device Monitor Function (Wiring Example of the Control Category 4)

This is the configuration for connecting auxiliary output and external device monitor input. At this time, set the auxiliary output with “negative logic of the control output (OSSD 1 / 2)” (factory setting). [Set through the handy controller (**SE9Z-HC**) (optional).] The auxiliary output cannot be connected to external devices.

It also enables the external device monitor function to be set at invalid by using the handy controller (**SE9Z-HC**) (optional).

<For PNP output>

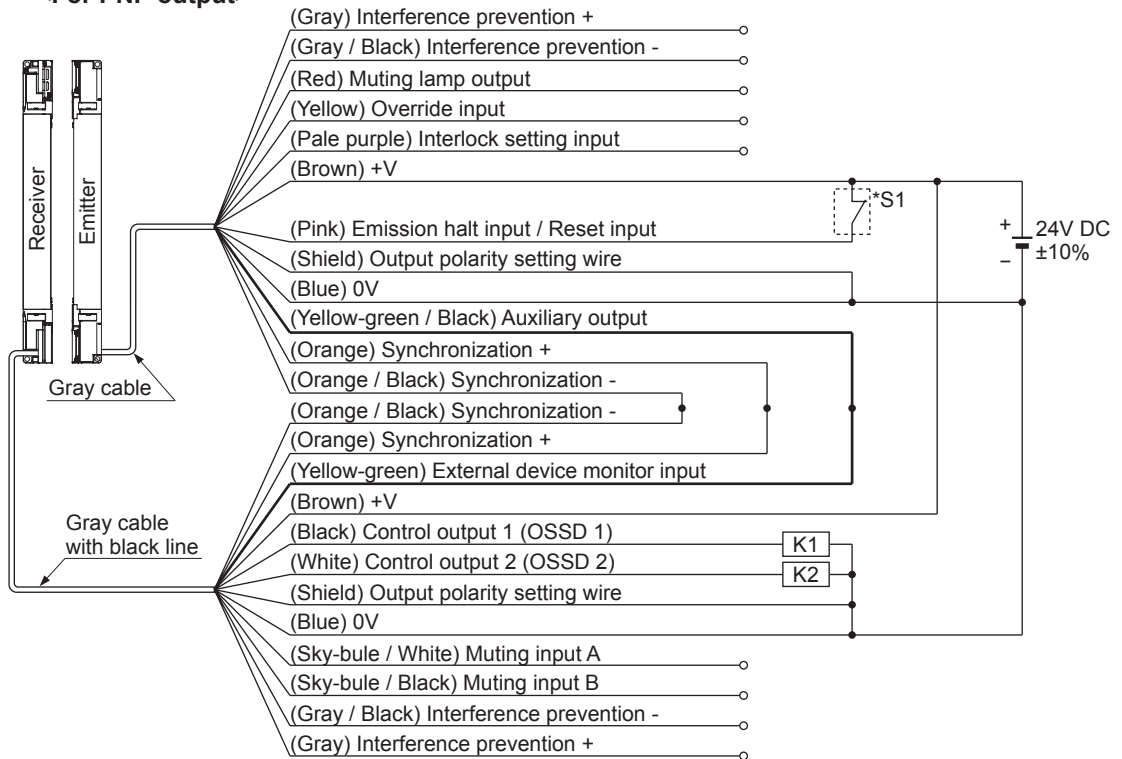

Interlock function	Invalid (Auto-reset)
External device monitor function	Invalid
Auxiliary output	Cannot be used

The device output is selected depending on the connecting state of the output polarity setting wire (shield). Incorrect wiring may cause the lockout state.

* Symbols

Switch S1

Vs to Vs - 2.5V (sink current 5mA or less): Emission (Note 1), Open: Emission halt

K1, K2: External device (Forced guided relay or magnetic contactor)

Notes: 1) Vs is the applying supply voltage.

2) The circuit diagram shown above is for 12-core cable to be used. For 8-core cable, red, yellow, gray, gray / black, sky-blue / white, sky-blue / black, there is no lead wire.

<For NPN output>

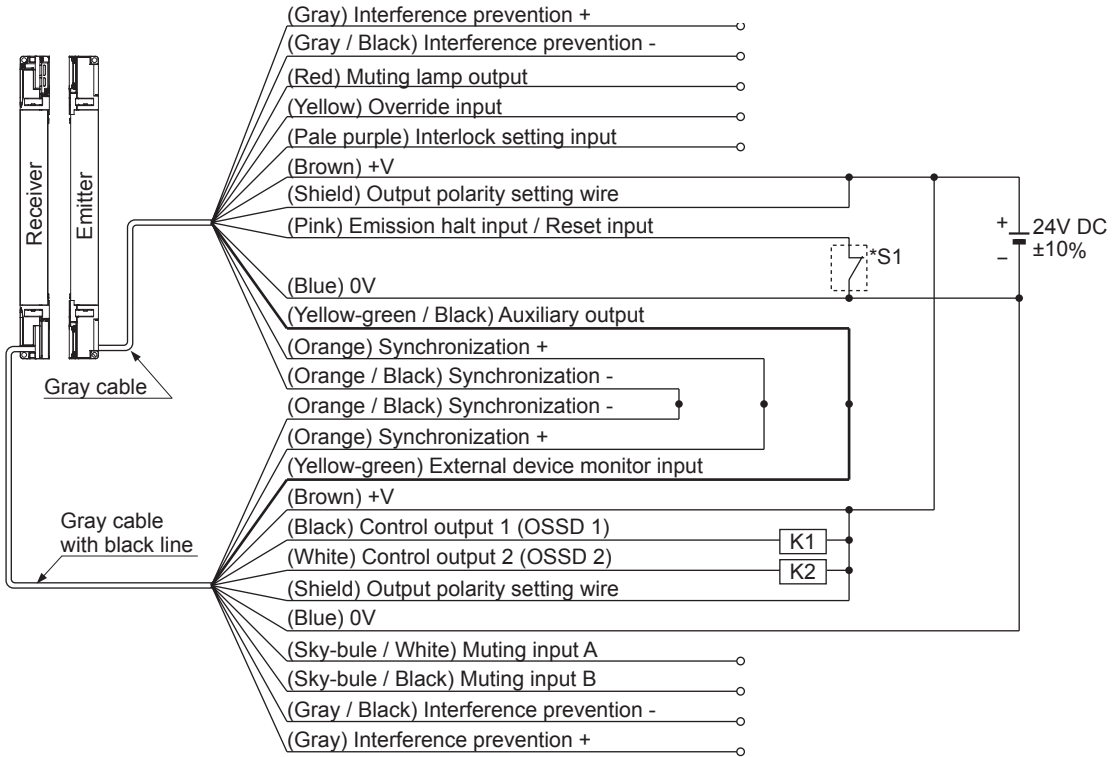

Interlock function	Invalid (Auto-reset)
External device monitor function	Invalid
Auxiliary output	Cannot be used

The device output is selected depending on the connecting state of the output polarity setting wire (shield). Incorrect wiring may cause the lockout state.

* Symbols

Switch S1
 0 to +1.5V (source current 5mA or less): Emission, Open: Emission halt
 K1, K2: External device (Forced guided relay or magnetic contactor)

Note: The circuit diagram shown above is for 12-core cable to be used. For 8-core cable, red, yellow, gray, gray / black, sky-blue / white, sky-blue / black, there is no lead wire.

2-5-11 Wiring Configuration for Valid Muting Function (Wiring Example of the Control Category 4)

<For PNP output>

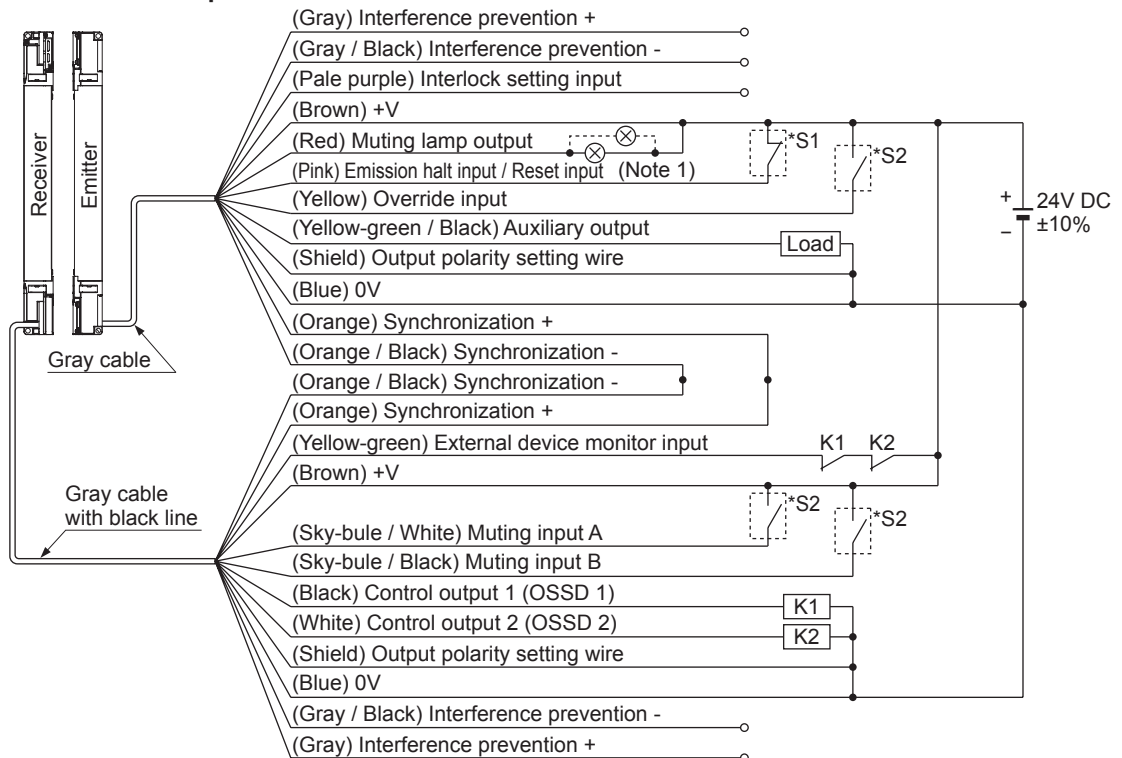

Interlock function	Invalid (Auto-reset)
External device monitor function	Valid
Auxiliary output	Can be used

The device output is selected depending on the connecting state of the output polarity setting wire (shield). Incorrect wiring may cause the lockout state.

* Symbols

Switch S1
Vs to Vs - 2.5V (sink current 5mA or less): Emission (Note 2), Open: Emission halt
Switch S2
The muting input, the override input
Vs to Vs - 2.5V (sink current 5mA or less): Valid (Note 2), Open: Invalid
K1, K2: External device (Forced guided relay or magnetic contactor)

Notes: 1) The incandescent lamp with 3 to 10W shall be connected to the muting lamp output. If the muting lamp is not connected, the muting function does not operate.
2) Vs is the applying supply voltage.

<For NPN output>

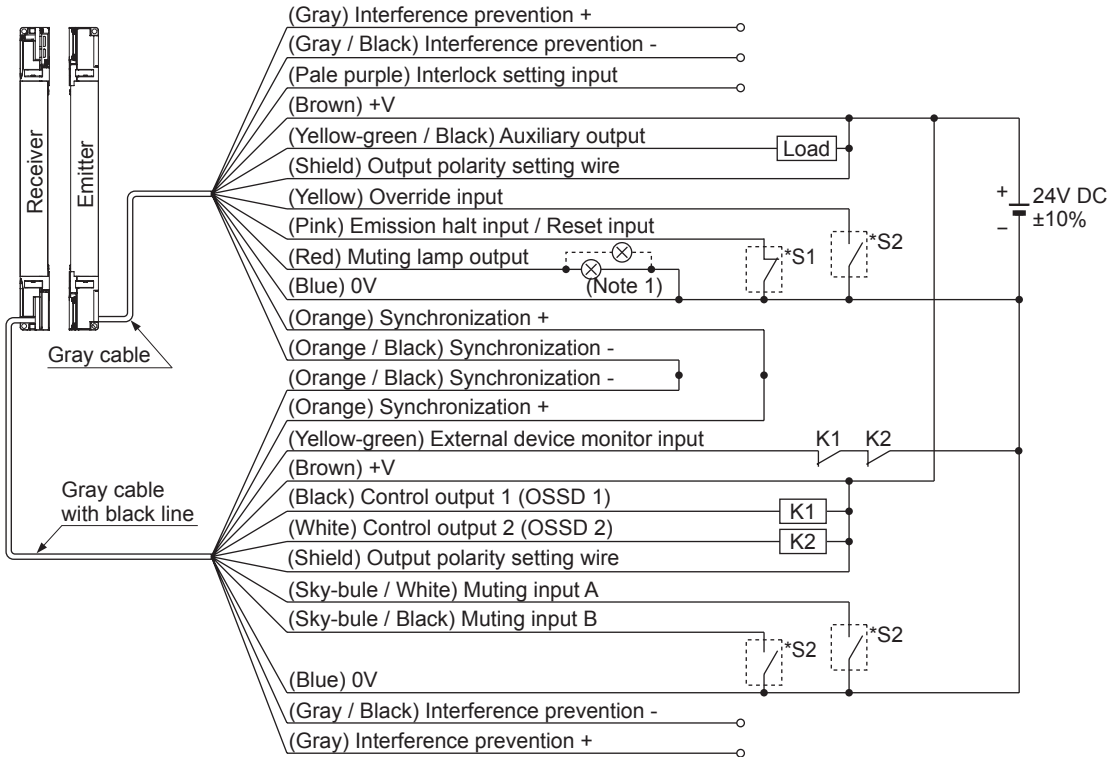

Interlock function	Invalid (Auto-reset)
External device monitor function	Valid
Auxiliary output	Can be used

The device output is selected depending on the connecting state of the output polarity setting wire (shield). Incorrect wiring may cause the lockout state.

* Symbols

Switch S1
 0 to +1.5V (source current 5mA or less): Emission, Open: Emission halt
 Switch S2
 The muting input, the override input
 0 to +1.5V (source current 5mA or less): Valid, Open: Invalid
 K1, K2: External device (Forced guided relay or magnetic contactor)

Note: The incandescent lamp with 3 to 10W shall be connected to the muting lamp output. If the muting lamp is not connected, the muting function does not operate.

2-6 Adjustment

2-6-1 Beam-axis Alignment

1. Turn ON the power supply unit of this device.
2. Check that the digital error indicator (red) and the fault indicator (yellow) of the emitter and receiver are OFF respectively.
If the digital error indicator (red) or the fault indicator (yellow) lights up or blinks, refer to “**Chapter 5 Troubleshooting**,” and report the symptoms to the maintenance in charge.
3. In case of using the intermediate supporting bracket (**SE9Z-SED-2**), loosen the two hexagon-socket head bolt [M5 (purchase separately)].
4. Loosen the hexagon-socket head bolt for beam axis alignment of the mounting bracket, and adjust the emitter / receiver so that the beam-axis alignment indicators in the display of the emitter and receiver light up.

The emitter and the receiver can be fine-adjusted by ± 15 degrees.

<In case of SE9Z-SED-1>

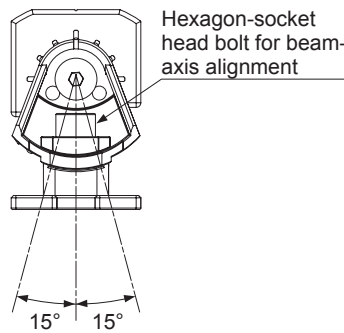

<Reference>

The beam-axis alignment indicator indicates the reception status for each section of the device which is divided into 4 sections.

Also, the A (D) of the beam-axis alignment indicates the light-receiving status of the device top end (bottom end).

For example, when using a 24-beam channel device, there are 6 beam channels per section (i.e., $24/4=6$). When the top end (bottom end) beam channel is received, the A (D) of the beam-axis alignment indicator blinks in red.

(Example) 24 beam channels

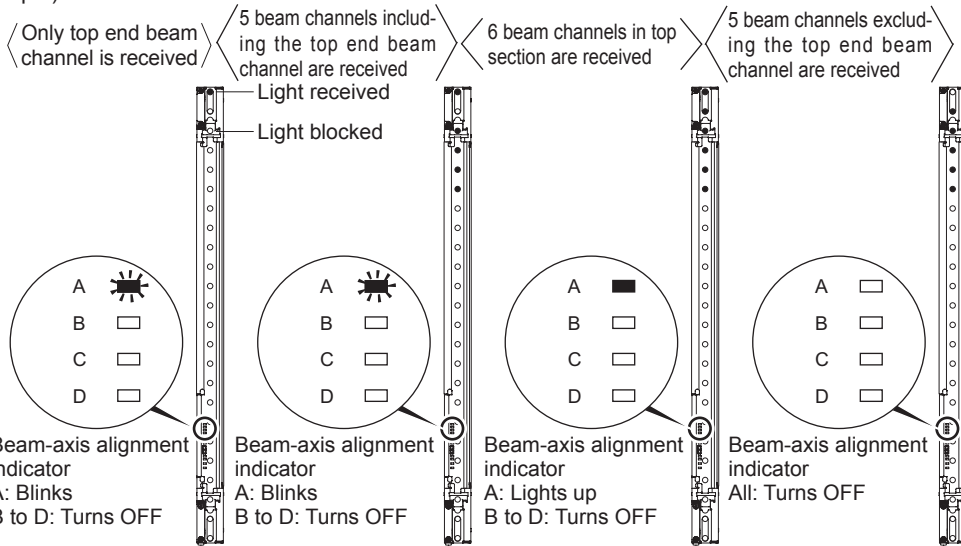

All the 6 beam channels divided into each section are received, the beam-axis alignment indicator lights up in red.

The indicators corresponding to the different sections light up in red, one by one, when the beam channels of the respective sections are received. When all the beam channels are received and the control output (OSSD 1 / 2) turns ON, all the four indicators of the beam-axis alignment indicator turn into green.

Refer to “2-6-2 Operation Test” for details.

- After the adjustment, tighten the hexagon-socket head bolt for beam-axis alignment of the mounting bracket. The tightening torque should be 2N·m or less.
- Tighten the two intermediate supporting brackets [M5 (purchase separately)]. Check, once again, that the beam-axis alignment indicators in the display of the emitter and receiver do light up.

CAUTION

After the beam-axis alignment is finished, make sure to confirm that all the bolts are tightened by the specified torque. For the tightening torque of each bolt, refer to “2-4 Mounting.”

2-6-2 Operation Test

1. Turn ON the power supply unit of this device.
2. Check that the digital error indicator (red) and the fault indicator (yellow) of the emitter and the receiver are OFF respectively.
If the digital error indicator (red) or the fault indicator (yellow) lights up or blinks, refer to “**Chapter 5 Troubleshooting**,” and report the symptoms to the maintenance in charge.
3. Move the test rod ($\phi 25\text{mm}$) up and down less than 1,600mm/sec. at three positions, just in front of the emitter (A), between the emitter and receiver (B), and just in front of the receiver (C).

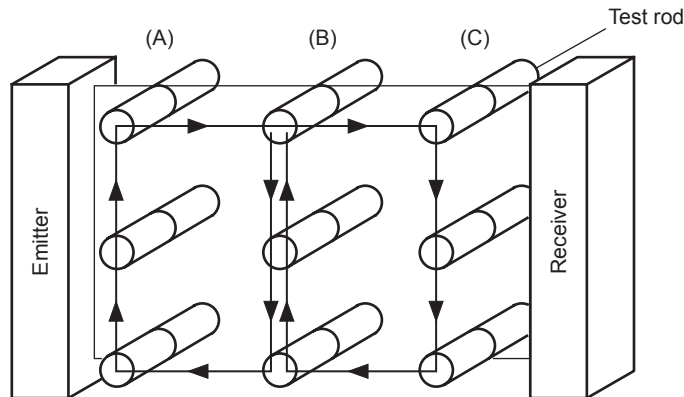

4. During Step 3 above, check that the control output (OSSD 1 / 2) is in OFF state, and both the OSSD indicator (red) of the receiver and the operation indicator (red) of the emitter light up as long as the test rod is present within the sensing area.
 - If the behavior of the control output (OSSD 1 / 2) and the turning ON / OFF of the emitter / receiver indicators do not correspond to the movement of the test rod, refer to “**Chapter 5 Troubleshooting**,” and report the symptoms to the maintenance in charge.





<Reference>





































If the indicators show reception of the light even though the test rod blocks the light, check whether there is any reflective object or extraneous light source near this device or not.

2-6-3 Operation

1) Normal Operation





The status of the emitter / receiver indicators during normal operation is as described below.





































: Blinks in red
 : Lights up in red
 : Lights up in green
 : Lights up in orange
 : Turns OFF

Device status	Indicators				Control output	
	Emitter		Receiver		OSSD 1	OSSD 2
Light received status (all beams received)	Beam-axis alignment indicator (Green)		Beam-axis alignment indicator (Green)		ON	
	Operation indicator (Green) (Note 1)		OSSD indicator (Green)			
	Incident light intensity indicator (Green)		Incident light intensity indicator (Green)			
	Fault indicator		Fault indicator			
	Digital error indicator		Digital error indicator			
	PNP indicator (Orange) (Note 2)		PNP indicator (Orange) (Note 2)			
	NPN indicator		NPN indicator			
	Emission intensity control indicator		Function setting indicator			
Emission halt indicator		Interlock indicator				
Light blocked status One or more lights blocked	Beam-axis alignment indicator (Red)		Beam-axis alignment indicator (Red)		OFF	
	Operation indicator (Red) (Note 1)		OSSD Indicator (Red)			
	Incident light intensity indicator		Incident light intensity indicator			
	Fault indicator		Fault indicator			
	Digital error indicator		Digital error indicator			
	PNP indicator (Orange) (Note 2)		PNP indicator (Orange) (Note 2)			
	NPN indicator		NPN indicator			
	Emission intensity control indicator		Function setting indicator			
Emission halt indicator		Interlock indicator				

Notes: 1) Since the color of the operation indicator changes according to the ON / OFF state of the control output (OSSD 1 / 2), the operation indicator is marked as OSSD on the device.

2) The status of the emitter / receiver indicators during the operation above shows the case in PNP output setting mode. In case of NPN output setting mode, the NPN indicator (orange) lights up.

 : Blinks in red
  : Lights up in red
  : Lights up in green
  : Lights up in orange
  : Turns OFF

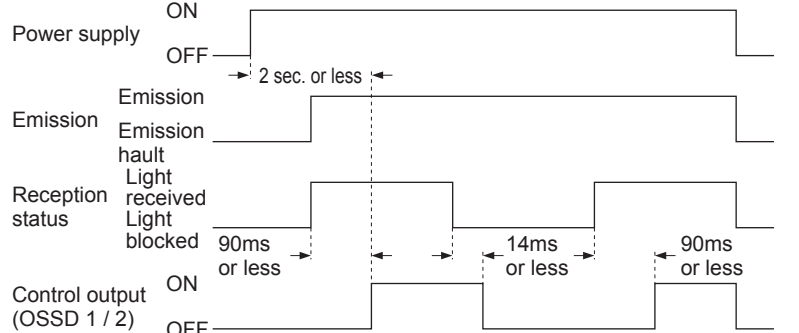
Device status	Indicators		Control output		
	Emitter	Receiver	OSSD 1	OSSD 2	
Light blocked status	Lights other than the top end blocked Beam-axis alignment indicator (Red)  Operation indicator (Red) (Note 1)  Incident light intensity indicator  Fault indicator  Digital error indicator  PNP indicator (Orange) (Note 2)  NPN indicator  Emission intensity control indicator  Emission halt indicator 	Beam-axis alignment indicator (Red)  OSSD indicator (Red)  Incident light intensity indicator  Fault indicator  Digital error indicator  PNP indicator (Orange) (Note 2)  NPN indicator  Function setting indicator  Interlock indicator 	OSSD 1	OSSD 2	OFF
	Lights other than the bottom end blocked Beam-axis alignment indicator (Red)  Operation indicator (Red) (Note 1)  Incident light intensity indicator  Fault indicator  Digital error indicator  PNP indicator (Orange) (Note 2)  NPN indicator  Emission intensity control indicator  Emission halt indicator 	Beam-axis alignment indicator (Red)  OSSD indicator (Red) (Note 1)  Incident light intensity indicator  Fault indicator  Digital error indicator  PNP indicator (Orange) (Note 2)  NPN indicator  Function setting indicator  Interlock indicator 	OSSD 1	OSSD 2	OFF
Time chart					

Notes: 1) Since the color of the operation indicator changes according to the ON / OFF state of the control output (OSSD 1 / 2), the operation indicator is marked as "OSSD" on the device.

2) The status of the emitter / receiver indicators during operation above shows the case in PNP output setting mode. In case of NPN output setting mode, the NPN indicator (orange) lights up.

<For series connection>

In case of series connection, if any of the sets is in light blocked status, the control output (OSSD 1 / 2) turns OFF.

<Reference>

The emitter / receiver indicators indicates the output status.

The following figure shows the status of the indicators with Sub sensor 2 in light blocked status.

■: Lights up in red ■■■: Lights up in orange □: Turns OFF

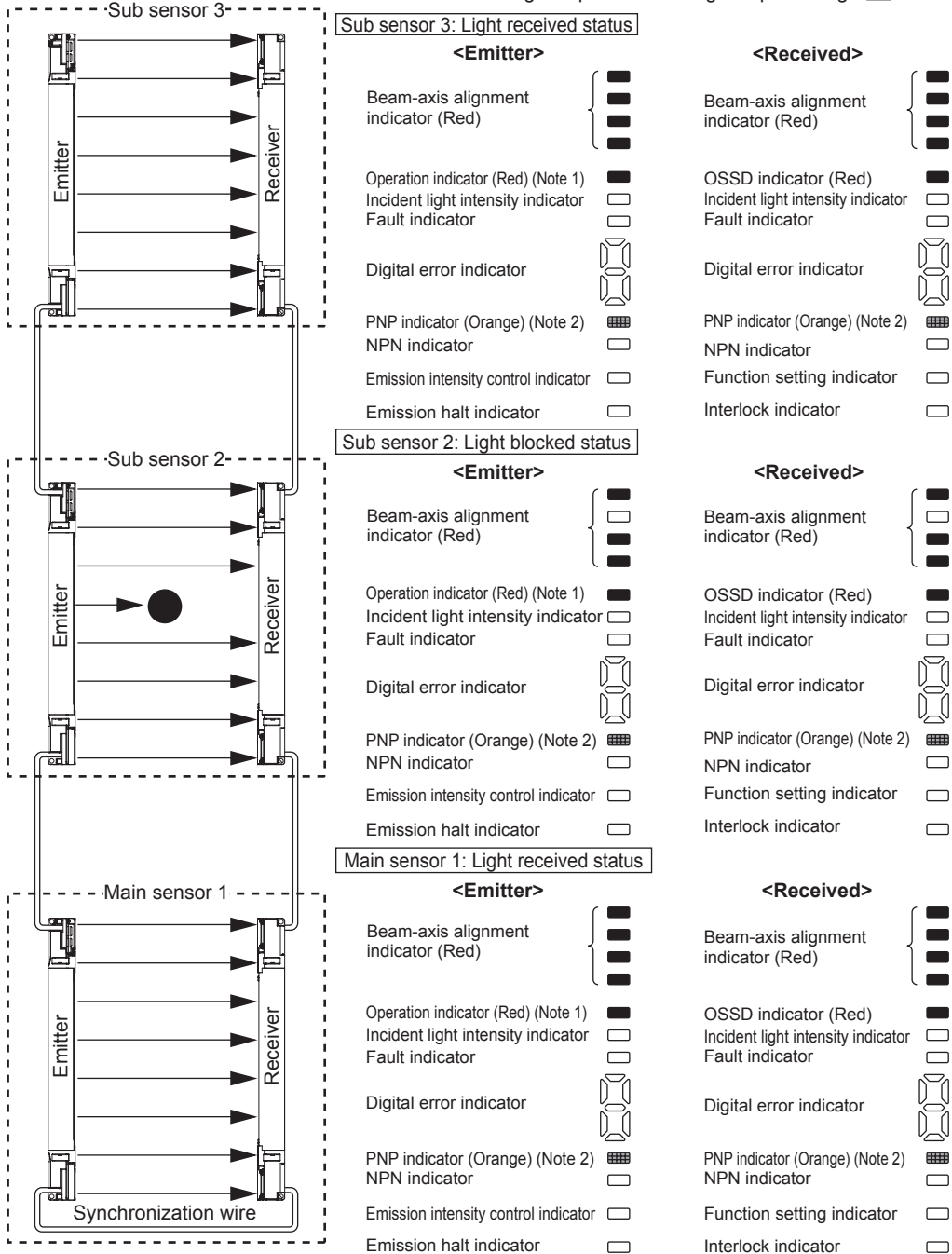

Notes: 1) Since the color of the operation indicator changes according to the ON / OFF state of the control output (OSSD 1 / 2), the operation indicator is marked as "OSSD" on the device.

2) The status of the emitter / receiver indicators during operation above shows the case in PNP output setting mode. In case of NPN output setting mode, the NPN indicator (orange) lights up.

<For parallel connection>

In case of parallel connection, for the control output (OSSD 1 / 2), only the set of which light is blocked turns OFF.

<Reference>

The emitter / receiver indicators indicate the output status.

The following figure shows the status of the indicators with Slave side 1 in light blocked status.

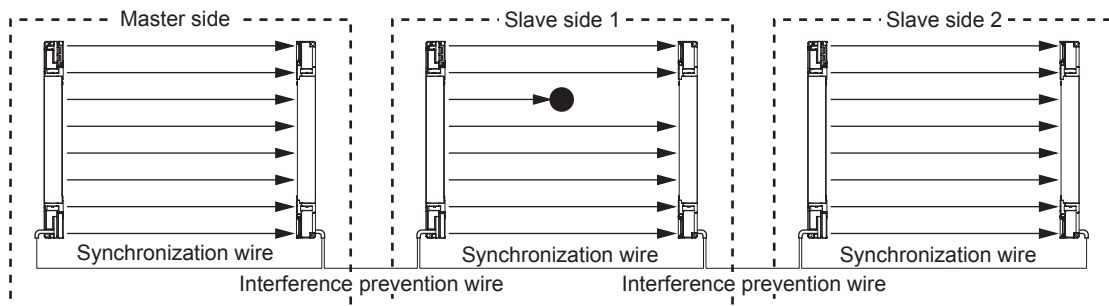

■: Lights up in red ▨: Lights up in green ▩: Lights up in orange □: Turns OFF

Master side: Light received status

<Emitter>

Beam-axis alignment indicator (Green)	
Operation indicator (Green) (Note 1)	
Incident light intensity indicator (Green)	
Fault indicator	
Digital error indicator	
PNP indicator (Orange) (Note 3)	
NPN indicator	
Emission intensity control indicator	
Emission halt indicator	

<Receiver>

Beam-axis alignment indicator (Green)	
OSSD indicator (Green)	
Incident light intensity indicator	
Fault indicator	
Digital error indicator	
PNP indicator (Orange) (Note 3)	
NPN indicator	
Function setting indicator	
Interlock indicator	

Slave side 1: Light blocked status

<Emitter>

Beam-axis alignment indicator (Red)	
Operation indicator (Red) (Note 1)	
Incident light intensity indicator	
Fault indicator	
Digital error indicator (Red) (Note 2)	
PNP indicator (Orange) (Note 3)	
NPN indicator	
Emission intensity control indicator	
Emission halt indicator	

<Receiver>

Beam-axis alignment indicator (Red)	
OSSD indicator (Red)	
Incident light intensity indicator	
Fault indicator	
Digital error indicator (Red) (Note 2)	
PNP indicator (Orange) (Note 3)	
NPN indicator	
Function setting indicator	
Interlock indicator	

Slave side 2: Light received status

<Emitter>

Beam-axis alignment indicator (Red)	
Operation indicator (Green) (Note 1)	
Incident light intensity indicator (Green)	
Fault indicator	
Digital error indicator (Red) (Note 2)	
PNP indicator (Orange) (Note 3)	
NPN indicator	
Emission intensity control indicator	
Emission halt indicator	

<Receiver>

Beam-axis alignment indicator (Red)	
OSSD indicator (Green)	
Incident light intensity indicator	
Fault indicator	
Digital error indicator (Red) (Note 2)	
PNP indicator (Orange) (Note 3)	
NPN indicator	
Function setting indicator	
Interlock indicator	

Notes: 1) Since the color of the operation indicator changes according to the ON / OFF state of the control output (OSSD 1 / 2), the operation indicator is marked as "OSSD" on the device.

2) When the devices are connected in parallel, the bottom of the digital error indicator on the slave side lights up in red. However, when the slave side is connected in series, only the indicator of the main sensor lights up.

3) The status of the emitter / receiver indicators during operation above shows the case in PNP output setting mode. In case of NPN output setting mode, the NPN indicator (orange) lights up.













































2) When using emission halt function

This device incorporates the emission halt function. Using this function, it is possible to simulate the light blocked status.

<Reference>





































When the emission halt input is kept open (for manual reset: connected to 0V, +V), the emitter stops emitting light. In this condition, if this device operates properly, the control output (OSSD 1 / 2) of the receiver turns OFF.

 Blinks in orange
  Lights up in red
  Lights up in green
  Lights up in orange
  Turns OFF

Setting procedure and check items	Indicators		Control output		
	Emitter	Receiver	OSSD 1	OSSD 2	
1 Before power is ON, Connect the emission halt input / reset input to Vs. (Note 3)	Beam-axis alignment indicator   Beam-axis alignment indicator  Operation indicator (Note 1)  Incident light intensity indicator  Fault indicator  Digital error indicator  PNP indicator  NPN indicator  Emission intensity control indicator  Emission halt indicator 	Beam-axis alignment indicator   Beam-axis alignment indicator  OSSD indicator  Incident light intensity indicator  Fault indicator  Digital error indicator  PNP indicator  NPN indicator  Function setting indicator  Interlock indicator 			OFF
2 After power is ON, Receiver's control output (OSSD 1 / 2) is ON. (Normal operation)	Beam-axis alignment indicator (Green)   Beam-axis alignment indicator (Green)  Operation indicator (Green) (Note 1)  Incident light intensity indicator (Green)  Fault indicator  Digital error indicator  PNP indicator (Orange) (Note 2)  NPN indicator  Emission intensity control indicator  Emission halt indicator 	Beam-axis alignment indicator (Green)   Beam-axis alignment indicator (Green)  OSSD indicator (Green)  Incident light intensity indicator (Green)  Fault indicator  Digital error indicator  PNP indicator (Orange) (Note 2)  NPN indicator  Function setting indicator  Interlock indicator 			ON

- Notes: 1) Since the color of the operation indicator changes according to the ON / OFF state of the control output (OSSD 1 / 2), the operation indicator is marked as "OSSD" on the device.
 2) The status of the emitter / receiver indicators during operation above shows the case in PNP output setting mode. In case of NPN output setting mode, the NPN indicator (orange) lights up.
 3) Vs is the applying supply voltage.

: Blinks in orange
 : Lights up in red
 : Lights up in green
 : Lights up in orange
 : Turns OFF

Setting procedure and check items		Indicators				Control output	
		Emitter		Receiver		OSSD 1	OSSD 2
3	Open the emission halt input / Reset output. Receiver's control output (OSSD 1 / 2) is OFF. (Emission halt) (Normal operation)	Beam-axis alignment indicator		Beam-axis alignment indicator		OFF	
		Operation indicator (Red) (Note 1)		OSSD indicator (Red)			
		Incident light intensity indicator		Incident light intensity indicator			
		Fault indicator		Fault indicator			
		Digital error indicator		Digital error indicator			
		PNP indicator (Orange) (Note 2)		PNP indicator (Orange) (Note 2)			
		NPN indicator		NPN indicator			
		Emission intensity control indicator		Func ion setting indicator			
Emission halt indicator (Orange)		Interlock indicator					
4	Connect the emission halt input to Vs. (Note 3) Receiver's control output (OSSD 1 / 2) is ON. (Normal operation)	Beam-axis alignment indicator (Green)		Beam-axis alignment indicator (Green)		ON	
		Operation indicator (Green) (Note 1)		OSSD indicator (Green)			
		Incident light intensity indicator (Green)		Incident light intensity indicator (Green)			
		Fault indicator		Fault indicator			
		Digital error indicator		Digital error indicator			
		PNP indicator (Orange) (Note 2)		PNP indicator (Orange) (Note 2)			
		NPN indicator		NPN indicator			
		Emission intensity control indicator		Func ion setting indicator			
Emission halt indicator		Interlock indicator					

- Notes: 1) Since the color of the operation indicator changes according to the ON / OFF state of the control output (OSSD 1 / 2), the operation indicator is marked as "OSSD" on the device.
- 2) The status of the emitter / receiver indicators during operation above shows the case in PNP output setting mode. In case of NPN output setting mode, the NPN indicator (orange) lights up.
- 3) Vs is the applying supply voltage.

3) When an error occurs

If a device error is detected, the device will turn the control output (OSSD 1 / 2) OFF. Then the digital error indicator (red) on the receiver lights up and the fault indicators (yellow) on the emitter and receiver light up or blink.

- If an emitter error is detected, the emitter will be locked out, stopping its emission, and the control output (OSSD 1 / 2) will be turned OFF.
- If a receiver error is detected, the receiver will be locked out, and the control output (OSSD 1 / 2) will go into OFF state. Also, the emission halt indicator (orange) of the emitter lights up.

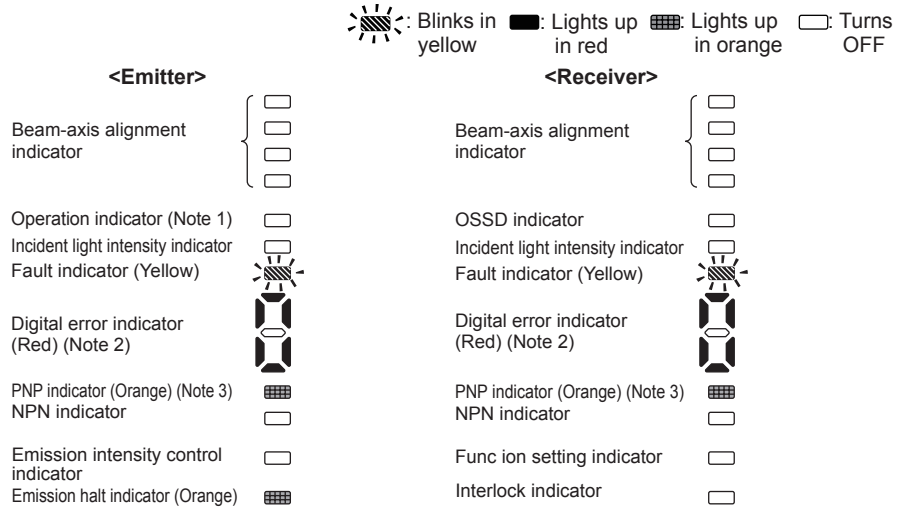

Notes: 1) Since the color of the operation indicator changes according to the ON / OFF state of the control output (OSSD 1 / 2), the operation indicator is marked as "OSSD" on the device.

2) Refer to "Chapter 5 Troubleshooting" for details of the digital error indicator.

3) The status of the emitter / receiver indicators during operation above shows the case in PNP output setting mode. In case of NPN output setting mode, the NPN indicator (orange) lights up.

Since this device will not return to normal operation automatically after the removal of the source of error, it is necessary to turn the power OFF and ON again.

(Source of error): The control output (OSSD 1 / 2) short-circuit, extraneous light detection, sensor failure, etc.

Refer to "Chapter 5 Troubleshooting" and remove the source of error.

Chapter 3 Functions

3-1 Self-diagnosis Function

This device incorporates the self-diagnosis function.

The self-diagnosis is carried out when the power is turned ON and while the operation periodically.

In case an abnormality is detected during self-diagnosis, the device is put in the lockout state at that instant, and the control output (OSSD 1 / 2) is fixed at the OFF state. Refer to “**Chapter 5 Troubleshooting**” and remove the cause of the abnormality.

3-2 Interlock Function

The selection of manual reset / auto reset is available by applying the interlock input wiring. The interlock becomes available by selecting manual reset.

Interlock setting input wire (pale purple)	Setting for interlock function
In case of selecting PNP output: connect to +V In case of selecting NPN output: connect to 0V	Manual reset
Open	Auto reset

⚠ WARNING

In case of using the interlock function, be sure there exists no operator inside of the dangerous area. it causes death or serious injury without the confirmation.

Manual reset: The control output (OSSD 1 / 2) is not turned ON automatically even though this device is received the light. When this device is reset in light received state [open the emission halt input / reset input → short-circuit the device to 0V or +V → open], the control output (OSSD 1 / 2) is turned ON.

<Timing chart>

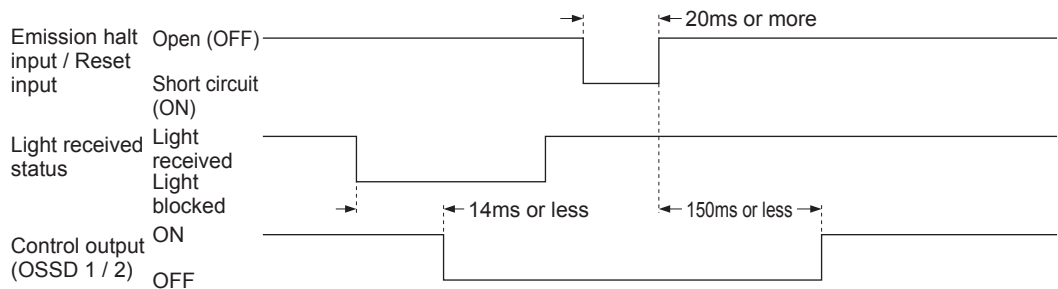

⚠ WARNING

The reset switch shall be placed in area where all over the dangerous zone shall be comprehend and out side of the dangerous zone.

Auto-reset: The control output (OSSD 1 / 2) is turned ON automatically when this device receives the light.

⚠ WARNING

If this device is used with the auto-reset, avoid an auto-restart after the safety output stop of the system by using a safety relay unit, etc. (EN 60204-1)

<Reference>

It is possible to change the conditions for interlocking by using the handy controller (**SE9Z-HC**) (optional).

3-3 Emission Halt Function

This function stops the emission process of the emitter.
 With the emission halt input line state, it enables to select either emission or emission halt.

Setting status of interlock function	Emission halt input / Reset input	Emission halt input	Control output (OSSD 1 / 2) status
Manual reset	Open	Invalid	ON
	When selecting PNP output: connect to +V When selecting NPN output: connect to 0V	Valid	OFF
Auto reset	Open	Valid	OFF
	When selecting PNP output: connect to +V When selecting NPN output: connect to 0V	Invalid	ON

During emission halt, the control output (OSSD 1 / 2) becomes OFF state.
 By using this function, malfunction due to extraneous noise or abnormality in the control output (OSSD 1 / 2) and the auxiliary output can be determined even from the equipment side.
 Normal operation is restored when the emission halt input / reset input is connected to 0V or +V (for manual reset: open).

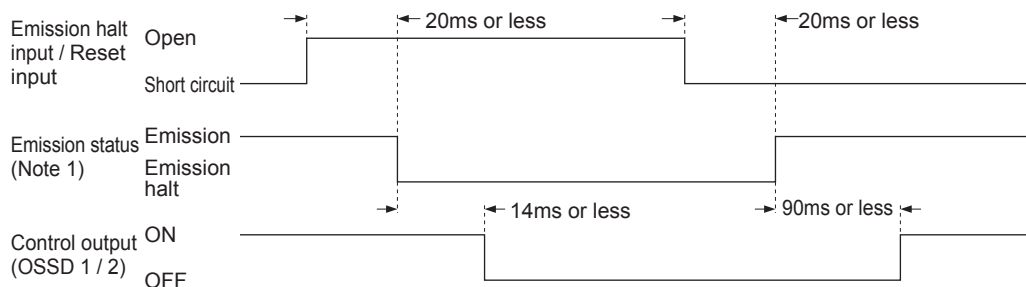

Note: This timing chart shows the operation in auto-reset mode. In manual reset mode, the device performs emission under open status and performs emission halt under short-circuit status.



WARNING

Do not use the emission halt function for the purpose of stopping the machine in which the **SE4D** series is installed. Failure to do so could result in death or serious injury.

3-4 Interference Prevention Function

It is possible to construct the system to prevent malfunction due to interference of the light between **SE4D** series devices.
 The interference prevention system can construct max. three sets of series and parallel mixed connection.
 The max. number of the beam channels in series and parallel mixed connection is 192.

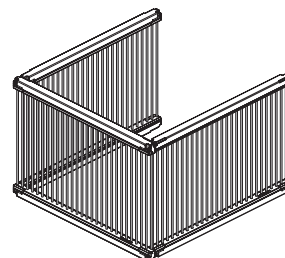

Refer to “**2-5 Wiring**” for details of the connecting method.

3-5 Auxiliary Output (Non-safety Output)

This device incorporates the auxiliary output for the non-safety output. The auxiliary output is incorporated in the emitter.

Auxiliary output setting	Normal mode			Lockout
	Emission halt input	Control output (OSSD 1 / 2) status		
		Light received	Light blocked	
Negative logic of OSSD (Factory setting)	ON	OFF	ON	ON

<Timing chart>

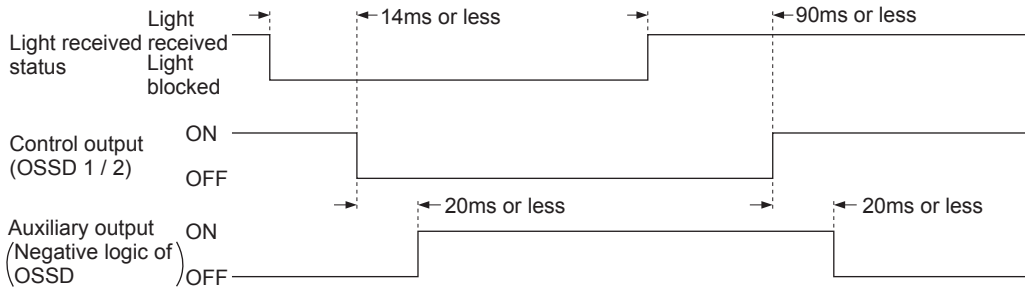

WARNING

Do not use the auxiliary output for the purpose of stopping the machine in which the **SE4D** series is installed. Failure to do so could result in death or serious injury.

<Reference>

It is possible to switch the output operation for auxiliary output by using the handy controller (**SE9Z-HC**) (optional).

3-6 External Device Monitor Function

This is the function for checking whether the external safety relay connected to the control output (OSSD 1 / 2) performs normally in accordance with the control output (OSSD 1 / 2) or not. Monitor the contacting point "b" of the external safety relay, and if any abnormality such as deposit of the contacting point, etc. is detected, change the status of the device into lockout one, and turn OFF the control output (OSSD 1 / 2).

- When the external device monitor function is set to be valid:**
 Connect the external device monitor input wire (yellow-green) to the external safety relay which is connected to the control output 1 (OSSD 1) wire (black) and the control output 2 (OSSD 2) wire (white).
- When the external device monitor function is set to be invalid:**
 Connect the external device monitor input wire (yellow-green) to the auxiliary output wire (yellow-green / black). At this time, the auxiliary output is set as [negative logic of control In case the external device monitor input function is invalid, output (OSSD 1 / 2)] (factory setting) [Set through the handy controller (**SE9Z-HC**) (optional)]. The auxiliary output cannot be connected to external devices.

<Reference>

It is also possible to set the external device monitor function into "invalid" by using the handy controller (**SE9Z-HC**) (optional).

<Timing chart (Normal)>

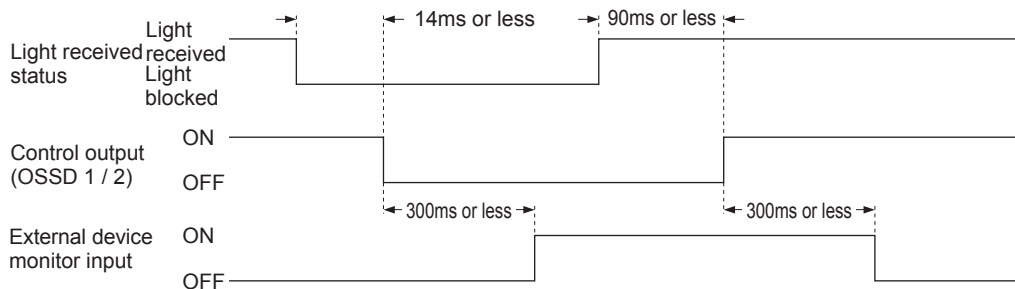

The setting time of the device monitor is 300ms or less. Exceeding 300ms turns the device into lockout status. It can be set within 100 to 600ms (unit: 10ms) by using the handy controller (**SE9Z-HC**) (optional).

<Timing chart (Error 1)>

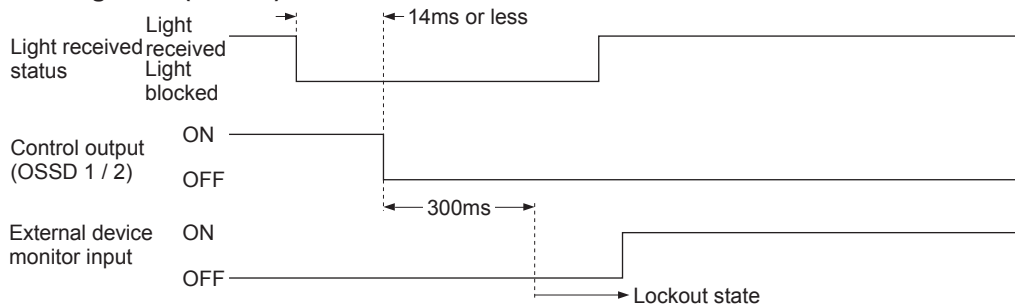

<Timing chart (Error 2)>

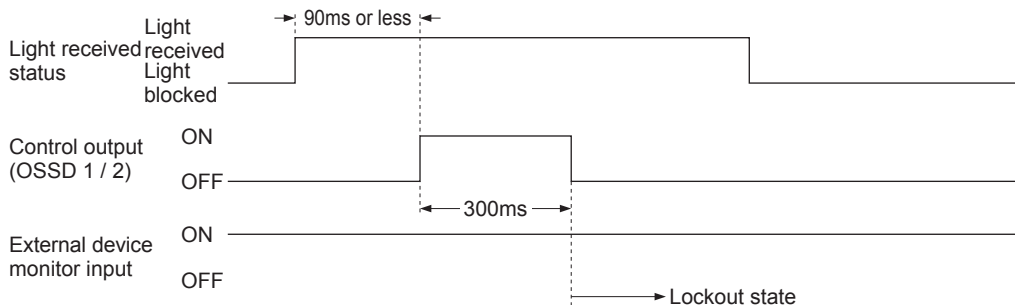

3-7 Muting Function

WARNING

- Incorrect using of the muting control may cause any accident. Please understand the muting control fully, and use it. As for the muting control, the following international standards define the requirements
ISO 13849-1 (EN ISO 13849-1 / JIS B 9705-1):
“Safety of machinery - Safety-related parts of control systems - Part 1: General principles for design, Article 5.9 Muting”
IEC 61496-1 (ANSI/UL 61496, JIS B 9704-1):
“Safety of machinery - Electro sensitive protective equipment - Part 1: General requirements and tests, Annex A, A.7 Muting”
IEC 60204-1 (JIS B 9960-1):
“Safety of machinery - Electrical equipment of machines - Part 1: General requirements, 9.2.4 Overriding safeguards”
EN 415-4:
“Safety of packaging machines - Part 4: Palletizers and depalletizers, Annex A, A2.2 Muting”
ANSI B11.19-1990:
“for Machine Tools-Safeguarding When Referenced by the Other B11 Machine Tool Safety Standards-Performance Criteria for the Design, Construction, Care, and Operation” 4.2.3 Presence-Sensing Devices: Electro-Optical and Radio Frequency (R.F.)
ANSI/RIA R15.06-1999:
“For Industrial Robots and Robot Systems - Safety Requirements, 10.4.5 Muting”
- Use the muting control while the machine cycle is not in danger mode. Maintain safety with the other measure while the muting control is activated.
- For the application that the muting control is activated when a workpiece passes through the sensor, place the muting sensor so that the conditions for the muting control cannot be satisfied by intrusion of personnel when the workpiece is passing through the sensor or the workpiece is not passing through it.
- The muting lamp should be installed in a position where it can always be seen by operators who set or adjust the machine.
- Be sure to check the operation of the muting function before its use. Furthermore, check the state of the muting lamp (cleanliness or brightness, etc.)

This function turns the safety function into invalid temporarily.

When the control output (OSSD 1 / 2) is ON, this function is available for passing the workpiece through the sensing area of the device without stopping the device.

The muting function becomes valid when all the conditions listed below are satisfied:

- The control output (OSSD 1 / 2) shall be ON.
- The incandescent lamp with 3 to 10W shall be connected to the muting lamp output. (Note 1)
- Muting input A and B shall be changed from OFF (open) to ON. At this time, the time difference occurred by changing the muting input A and B into ON status shall be 0.03 to 3 sec. (Note 2)

The following devices, photoelectric sensor with semiconductor output, inductive proximity sensor, position switch on NO (Normally Open) contacting point, etc. are available for applying to the muting sensor.

Notes: 1) The muting lamp diagnosis function can be set with the handy controller (**SE9Z-HC**) (optional).

If the muting lamp diagnosis function is set to be invalid, the muting function is maintained even if a lamp blows or a lamp is not connected.

- 2) 0 to 3 sec. is allowable by using the handy controller (**SE9Z-HC**) (optional) and connecting NO (Normally Open) type muting sensor to the input A, as well as connecting NC (Normally Closed) type muting sensor to the input B.

<Output operation of muting sensors>

	Operation at ON state	Operation at OFF state
NO (Normally Open) type ON with light non-received status (photoelectric sensor, etc.) ON with object approaching status (inductive proximity sensor, etc.) ON with object contacted status (position switch, etc.)	Output 0V or +V	Open

⚠ WARNING

Be sure to use a muting sensor that satisfies the <Output operation of muting sensors> above. If the other muting sensor not satisfying the specification above, the muting function might become valid with the timing that the machine designer cannot expect and could result in death or serious injury.

<Installation condition example of muting sensors>

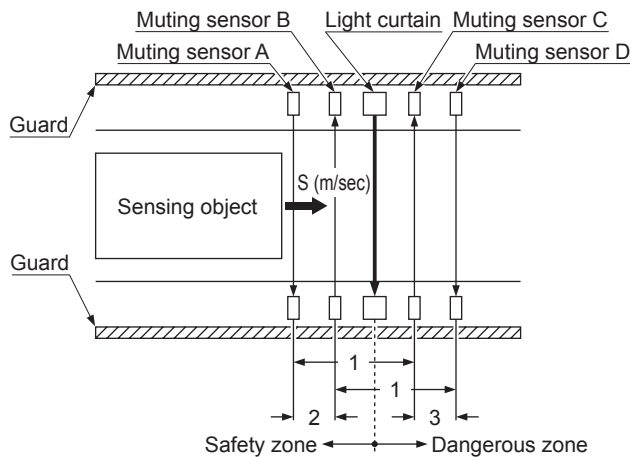

- 1) Shorten the distances between muting sensors A to C and between B to D than the whole length of the sensing object.
- 2) The time of the sensing object to be passed through the muting sensors A to B shall be 0.03 to under 3 sec.
 $\text{Distance between A and B (m)} < S \text{ (m/sec.)} \times 3 \text{ (sec.)}$
 S: The moving speed (m/sec.) of the sensing object
- 3) The time of the sensing object to be passed through the muting sensors C to D shall be under 3 sec.
 $\text{Distance between C and D (m)} < S \text{ (m/sec.)} \times 3 \text{ (sec.)}$
 S: The moving speed (m/sec.) of the sensing object.

<For PNP output>

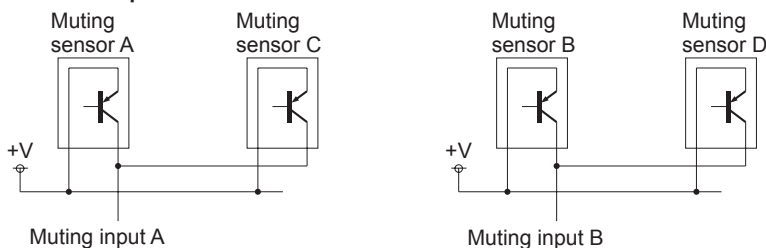

<For NPN output>

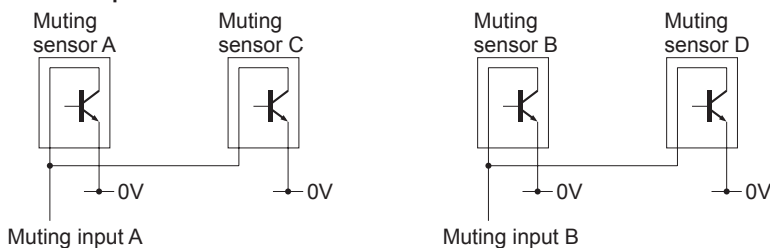

<Timing chart>

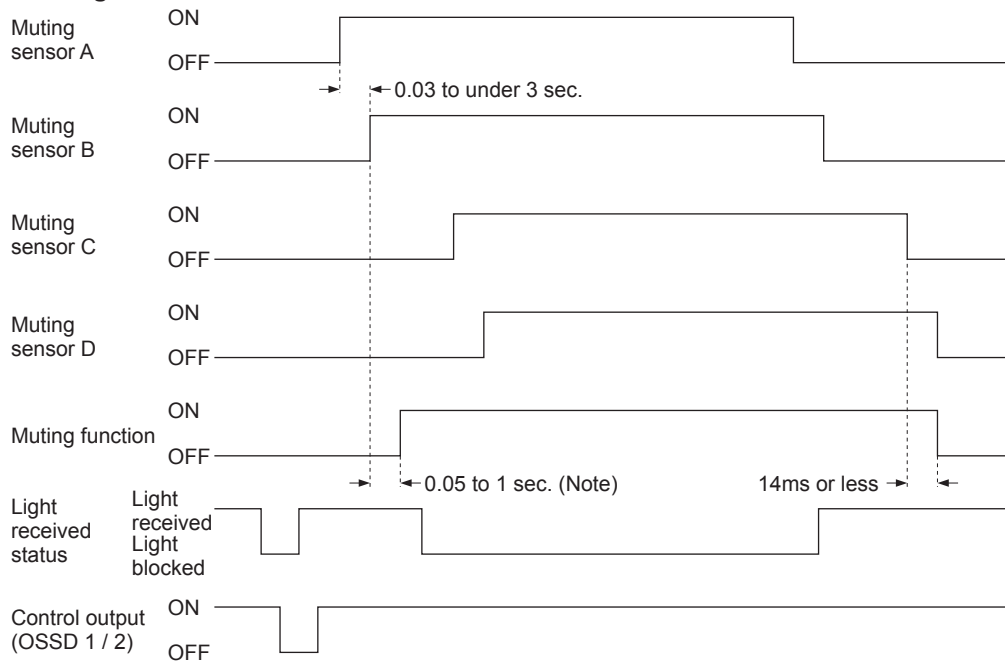

Note: This is when the muting lamp diagnosis function is valid. If the muting lamp does not light up even if 1 sec. is passed, the muting function becomes invalid. When the muting lamp diagnosis function is invalid, the muting function becomes valid 0.05 sec. after the input conditions of the muting sensor A (C) and B (D) were satisfied.

<Reference>

- It is possible to set the muting function into invalid per beam channel respectively and to specify the input order of the muting input A and B to be set into valid by using the handy controller (**SE9Z-HC**) (optional).
- It is recommended that two muting lamps should be connected in parallel. In this case, take care not to exceed 10W.

3-8 Override Function

WARNING

- Incorrect using of the muting control may cause any accident. Please understand the muting control fully, and use it. As for the muting control, the following international standards define the requirements
ISO 13849-1 (EN ISO 13849-1, JIS B 9705-1):
“Safety of machinery - Safety-related parts of control systems - Part 1: General principles for design, Article 5.9 Muting”
IEC 61496-1 (ANSI/UL 61496, JIS B 9704-1):
“Safety of machinery - Electro sensitive protective equipment - Part 1: General requirements and tests, Annex A, A.7 Muting”
IEC 60204-1 (JIS B 9960-1):
“Safety of machinery - Electrical equipment of machines - Part 1: General requirements, 9.2.4 Overriding safeguards”
EN 415-4:
“Safety of packaging machines - Part 4: Palletizers and depalletizers, Annex A, A2.2 Muting”
ANSI B11.19-1990:
“for Machine Tools-Safeguarding When Referenced by the Other B11 Machine Tool Safety Standards-Performance Criteria for the Design, Construction, Care, and Operation” 4.2.3 Presence-Sensing Devices: Electro-Optical and Radio Frequency (R.F.)
ANSI/RIA R15.06-1999:
“For Industrial Robots and Robot Systems - Safety Requirements, 10.4.5 Muting”
- Use the muting control while the machine cycle is not in danger mode. Maintain safety with the other measure while the muting control is activated.
- For the application that the muting control is activated when a workpiece passes through the sensor, place the muting sensor so that the conditions for the muting control cannot be satisfied by intrusion of personnel when the workpiece is passing through the sensor or the workpiece is not passing through it.
- The muting lamp should be installed in a position where it can always be seen by operators who set or adjust the machine.
- Be sure to check the operation of the muting function before its use. Furthermore, check the state of the muting lamp (cleanliness or brightness, etc.)

The override function forcibly turns the safety function into invalid. This function is used for the following cases: when the customer who uses the muting function needs to start the device with the control output (OSSD 1 / 2) be OFF status, when the device is required to continue operating even though the muting sensor becomes valid after the muting sensor is turned ON at the starting of line.

The override function becomes valid when all the conditions listed below are satisfied:

- The incandescent lamp with 3 to 10W shall be connected to the muting lamp output. (Note 1)
- The signal shall be input to either muting input A or B, or to both of the inputs.
- The override input shall be short-circuited to 0V or +V, and the emission halt input / reset input shall be opened. (3 sec. continuously)

If one of the three conditions above becomes invalid or timing exceeds 60 sec. (Note 2), the override function becomes invalid.

Notes: 1) The muting lamp diagnosis function can be set with the handy controller (**SE9Z-HC**) (optional).

If the muting lamp diagnosis function is set to be invalid, the muting function is maintained even if a lamp blows or a lamp is not connected.

- 2) By using the handy controller (**SE9Z-HC**) (optional), the timing can be changed in the range of 60 to 600 sec. in units of 10 sec.
- 3) The override function operates only when the auto-reset is ON (the interlock is invalid).

WARNING

- Make sure manually to operate system for starting override function. Furthermore, the system shall be placed in area where all over the dangerous zone shall be comprehend and out side of the dangerous zone.
- Using override function, make sure that there exist no operator in the dangerous zone, which may result in death or serious injury.

Timing chart

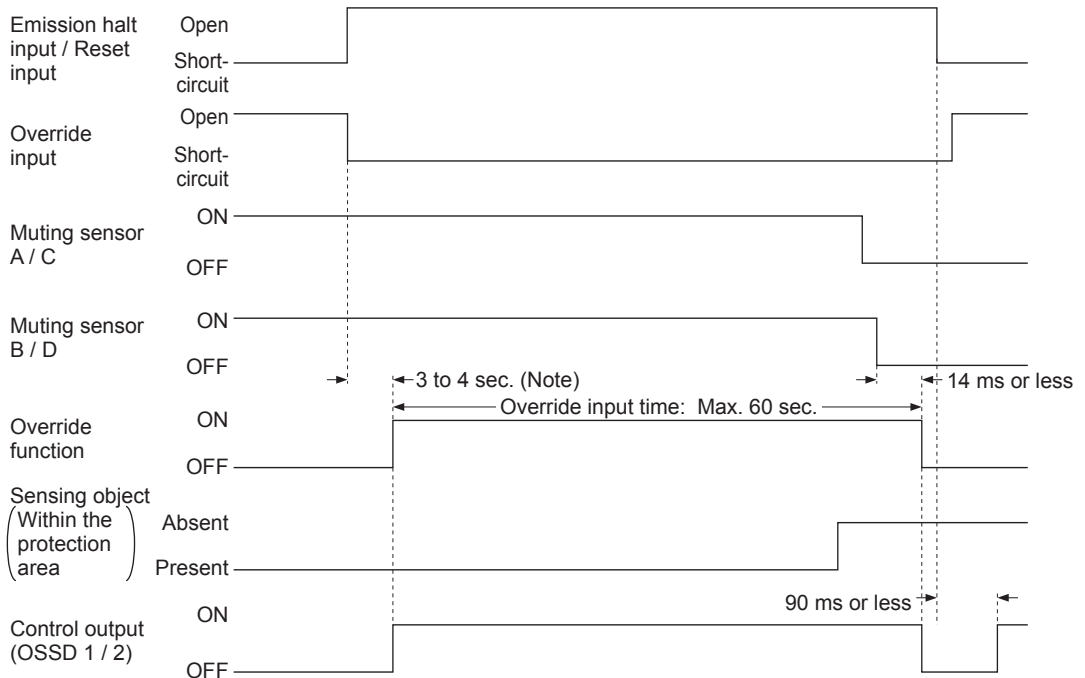

Note: This is when the muting lamp diagnosis function is valid. If the muting lamp does not light up even if 1 sec. is passed, the override function becomes invalid. When the muting lamp diagnosis function is invalid, the muting function becomes valid 3 sec. after the input conditions of the muting sensor A (C) and B (D) were satisfied.

3-9 Functions Using Handy Controller (SE9Z-HC) (Optional)

This device enables to set each function using the handy controller (**SE9Z-HC**) (optional). The settable functions and the factory setting of each function are as follows.

For details, refer to the instruction manual enclosed with the handy controller.

⚠ WARNING

Among the functions, the contents related to the safety distance such as the size of the minimum sensing object are varied depending on the setting condition. When setting each function, re-calculate the safety distance, and make enough space larger than the calculated safety distance. Failure to do so might cause the accident that the device cannot stop quickly before reaching the dangerous area of the device, resulting in the death or serious injury.

- **Fixed blanking function**

This function enables to protect the control output (OSSD 1 / 2) from turning into OFF even though the specific beam channel is blocked.

The factory setting is set to be invalid for the fixed blanking function.

- **Floating blanking function**

This function enables to protect the control output (OSSD 1 / 2) from turning into OFF even though the number of the blocked beam channels are lower than that of the setting beam channels. 1, 2 or 3 beam channels are settable as the blocking beam channels.

The factory setting is set to be invalid for the floating blanking function.

Both fixed blanking function and floating blanking function are settable simultaneously.

- **Emission amount control function**

The two modes, normal mode and short mode, can be set / changed by controlling the emission amount. The factory setting is set to the normal mode for the emission amount control function.

- **Auxiliary output switching function (non-safety output)**

The following outputs are switchable as the auxiliary output.

0. Negative logic of the control output (OSSD 1 / 2) (factory setting)
1. Positive logic of the control output (OSSD 1 / 2)
2. For emission: output ON, For non-emission: output OFF
3. For emission: output OFF, For non-emission: output ON
4. For unstable incident light: OFF (Note 1)
5. For unstable incident light: ON (Note 1)
6. For muting: ON
7. For muting: OFF
8. For light reception: ON, For light blocked: OFF (Note 2)
9. For light reception: OFF, For light blocked: ON (Note 2)

Notes: 1) The output cannot be used while the fix blanking function, floating blanking function or the muting function is activated.

- 2) This device outputs the light received / blocked state under activating the auxiliary output switching function using the handy controller irrespective of activating other functions: fixed blanking function, floating blanking function and muting function.

<e.g.>

In case of activating the fixed blanking function, the control output (OSSD 1 / 2) becomes ON with the shielded object existed in the setting range and other ranges are in light receiving status.

If the auxiliary output switching function activates in No. 8 output, this device becomes OFF because the sensor itself detects the object.

- **Interlock setting changing function**

It is selectable one interlock state among the following three interlock settings

- **Start / Restart interlock**

The device goes into the interlock state after the power is turned ON, or when the light is blocked.

The factory setting is start / restart interlock.

- **Start interlock**

The device goes into the interlock state when the power supply is turned ON. Once this interlock is reset, the device does not go into the interlock state.

- **Restart interlock**

The device does not go into the interlock state when turning ON the power supply. Only when the control output (OSSD 1 / 2) becomes ON and the light is blocked after the power is turned ON and this device receives the light, the device goes into the interlock state.

- **External device monitor setting changing function**

The setting of the external device monitor is changeable.

1. Allowable time for response time: 100 to 600ms (Unit: 10ms)

Factory setting is 300ms.

2. The external device monitor function can be selected to valid or invalid.

The factory setting is set to valid for the external device monitor function.

● **Muting setting changing function**

The setting of the muting function is changeable.

1. Input order of the muting input A and B can be specified so that the muting function will be valid.

The muting function will be valid either the muting input A or B comes first to input at the time of factory setting.

2. Select either to validate or invalidate the muting function per beam channel. (Note 1)
The muting function is valid in all beam channels at the time of factory setting.
3. Select either to validate or invalidate the muting lamp diagnosis function. (Note 2)
The muting lamp diagnosis function is valid at the time of factory setting.
4. Output operation of a muting sensor which is to be connected to the muting input of this device can be set with the handy controller (**SE9Z-HC**) (optional). (Note 3, 4)

- **NONO (Normally Open, Normally Open)**

It is at the time of factory setting.

- **NONC (Normally Open, Normally Closed)**

Connect a sensor or switch whose output operation is NO (Normally Open) type to the muting input A and connect a sensor or switch whose output operation is NC (Normally Closed) type to the muting input B.

To make the muting function valid, time difference between the time during muting input A becomes ON from OFF (Open) and the time during muting input B becomes OFF (Open) from ON should be within 3 sec.

<Output operations of muting sensors (when setting to NONC)>

	Muting input	Operation at ON state	Operation at OFF state
NO (Normally Open) type ON with light non-received status (photoelectric sensor, etc.) ON with object approaching status (inductive proximity sensor, etc.) ON with object contacted status (position switch, etc.)	A	0V or +V	Open
NC (Normally Closed) type ON with light received status (photoelectric sensor, etc.) ON with object non-approaching status (inductive proximity sensor, etc.) ON with object non-contacted status (position switch, etc.)	B		

- Notes: 1) If a beam channel whose muting function is set to be invalid is blocked during the muting, the control output (OSSD 1 / 2) will be turned OFF and the muting function will be released.
- 2) Selectable with the handy controller (**SE9Z-HC**) (optional). If the muting lamp diagnosis function is set to be invalid, the muting function is maintained even if a lamp blows or a lamp is not connected.
 - 3) Selectable with the handy controller (**SE9Z-HC**) (optional).
 - 4) The muting function will be invalid if the muting sensor which is connected to the muting input of this device differs from the output operation which is set with the handy controller (**SE9Z-HC**) (optional).

● **Override setting changing function (Note)**

Maximum continuous effective time set at the override function can be changed.

The maximum continuous effective time can be set in the range of 60 to 600 sec. (in units of 10 sec.).

Note: Selectable with the handy controller (**SE9Z-HC**) (optional).

● **Protective function**

Unless the password is inputted, any change in setting of the device is not allowed.

The factory setting is set to be invalid for the protective function.

Chapter 4 Maintenance

<Reference>

When any errors are found, refer to “**Chapter 5 Troubleshooting**” and report the symptoms to the maintenance in charge. If the rectification method is not clear, please contact our office.
Please make a copy of this checklist, check each inspection item in the respective square, and file the list for record.

4-1 Daily Inspection



WARNING

Be sure to inspect the following items prior to operation and confirm that there is no error.

Operating this device without inspection or in an error condition can result in death or serious injury.

Check list (Daily inspection)

Check column	Inspection item
<input type="checkbox"/>	Dangerous parts of the machine cannot be reached without passing through the sensing area of this device.
<input type="checkbox"/>	Some part of operator's body remains in the sensing area when operation is done with dangerous parts of the machine.
<input type="checkbox"/>	The calculated safety distance has been maintained or exceeded during installation.
<input type="checkbox"/>	There is no damage to the safety guard or protective structure.
<input type="checkbox"/>	There is no defect, fold, or damage in the wiring.
<input type="checkbox"/>	The corresponding connectors have been connected securely.
<input type="checkbox"/>	No dirt or scratches exist on the light emitting surface.
<input type="checkbox"/>	The test rod is not deformed or defective.
<input type="checkbox"/>	The operation indicator (green) of the emitter and the OSSD indicator (green) of the receiver light up when no object is present in the sensing area. The control output (OSSD 1 / 2) is in ON status. At this time, the effect of external noise can be inspected. In case external noise affects the operation, remove its cause and reinspect.
<input type="checkbox"/>	<p>The test rod ($\phi 25\text{mm}$) can be detected less than 1,600mm/sec. at three positions, directly in front of the emitter (A), midway between the emitter and the receiver (B), and directly in front of the receiver (C). The OSSD indicator (red) of the receiver and the operation indicator (red) of the emitter continue to light up as long as the test rod is present in the sensing area from (A) to (C).</p>
<input type="checkbox"/>	With the machine in the operating condition, the dangerous parts operate normally when no object is present in the sensing area.
<input type="checkbox"/>	With the machine in the operating condition, the dangerous parts stop immediately when the test rod is inserted into the sensing area at any of the three positions, directly in front of the emitter (A), midway between the emitter and the receiver (B), and directly in front of the receiver (C).
<input type="checkbox"/>	The dangerous parts remain stopped as long as the test rod is present in the sensing area.
<input type="checkbox"/>	The dangerous parts stop immediately when the power supply of this device is turned OFF.
<input type="checkbox"/>	The control output (OSSD 1 / 2) must turn OFF when the emission halt input / reset input wire (pink) is open (for manual reset: connected to 0V, +V). At this time, the effect of external noise can be inspected. In case external noise affects the operation, remove its cause and reinspect.
<input type="checkbox"/>	Be sure to check the operation of the muting function before its use. Furthermore, check the state of the muting lamp (cleanliness or brightness etc.).

4-2 Periodic Inspection (Every Six Months)



WARNING

Be sure to inspect the following items every six months and confirm that there is no error. Operating this device without inspection or in an error condition can result in death or serious injury.

Check list (Periodic inspection)

Check column	Inspection item
<input type="checkbox"/>	The structure of the machine does not obstruct any safety mechanism for stopping operation.
<input type="checkbox"/>	No modification has been made in the machine controls which obstructs the safety mechanisms.
<input type="checkbox"/>	The output of this device is correctly detected.
<input type="checkbox"/>	The wiring from this device is correct.
<input type="checkbox"/>	The overall response time of the complete machine is equal or less than the calculated value.
<input type="checkbox"/>	The actual number of operation cycle (time) of the limited lifetime parts (relay, etc.) is less than their rated operation cycles (time).
<input type="checkbox"/>	No screws or connectors of this device are loose.
<input type="checkbox"/>	No extraneous light source or reflective object has been added near this device.

4-3 Inspection after Maintenance

Under the following situations, perform all the inspection items mentioned in “4-1 Daily Inspection” and “4-2 Periodic Inspection (Every Six Months).”

- 1) When any parts of this device are replaced.
- 2) When some abnormality is felt during operation.
- 3) When beam-axis alignment of the emitter and receiver is done.
- 4) When the device installation place or environment is changed.
- 5) When the wiring method or wiring layout is changed.
- 6) When FSD (Final Switching Device) parts are replaced.
- 7) When FSD (Final Switching Device) setting is changed.

Chapter 5 Troubleshooting

<Reference>

- Check the wiring.
- Check the power supply voltage and the power supply capacity.

5-1 Troubleshooting of Emitter

<All indicators are OFF>

Cause	Remedy
Power is not being supplied	Check that the power supply capacity is sufficient. Connect the power supply correctly.
Supply voltage is out of the specified range.	Set the supply voltage correctly.
Connector is not connected securely.	Connect the connector securely.

<Fault indicator (yellow) lights or blinks>

Cause	Remedy	
[Digital error indicator: 1] Setting data error of this device	Series connection is incorrect.	Check that the cable for series connection does not short-circuit, or is connected to the correct position (emitter for emitter, receiver for receivers). In case the handy controller (SE9Z-HC) (optional) is applied, reset the function.
	Noise is out of the specified range.	Check the noise status around this device. In case the handy controller (SE9Z-HC) (optional) is applied, reset the function.
	Internal error	Contact our office.
[Digital error indicator: 1] System error between emitter and receiver	Systems are different between emitter and receiver.	Set the same value to the numbers of emitter and receiver and that of beam channel, and the shield wires.
[Digital error indicator: 2] Series connection error	The serial signal short-circuits or comes down.	Check if the end cap has been fitted properly. Check that the cable for series connection does not short-circuit, or is connected to the correct position (emitter for emitter, receiver for receiver). Check the error contents of the device connected by the cable for series connection.
	Any of the main / sub sensor is in error.	
[Digital error indicator: 3] No. of total units / No. of total beam channels error	No. of total units / No. of total beam channels is out of the specified range.	Set the condition of the series connection within the specification. Refer to " 2-5-6 Series Connection. "
[Digital error indicator: 4] Interlock setting error	Voltage level of interlock setting input wire (pale purple), or emission halt input / reset input wire (pink) is unstable.	Wire the interlock setting input wire (pale purple) and emission halt input / reset input wire (pink) correctly.
[Digital error indicator: 5 5] Muting lamp error	Muting lamp output wire (red) short-circuits with 0V or +V.	Wire the muting lamp output wires (red) correctly. Refer to " 2-5 Wiring. " Current value should be within the specified muting lamp output.
	Muting lamp output wire (red) short-circuits with other I/O wires.	
	Excessive incoming current flows in the muting lamp output.	
	Output polarity setting wire (shield) and muting lamp output wire (red) are not correctly wired.	Wire the output polarity setting wire (shield) correctly. (0V: PNP output, +V: NPN output). Wire the muting lamp output wire (red) correctly. Refer to " 2-5 Wiring. "
Output circuit error	Output circuit is damaged. Replace this device.	

Cause		Remedy
[Digital error indicator: \bar{E}] Output polarity setting wire (shield) error	Output polarity setting wire (shield) comes down or short-circuits with other I/O wires. Output polarity setting wire (shield) connection of emitter / receiver is incorrect.	Wire the output polarity setting wire (shield) correctly. (0V: PNP output, +V: NPN output) Wire the output polarity setting wire (shield) of the receiver correctly.
[Digital error indicator: \bar{F}] Effect from noise / power supply or failure of internal circuit	Affected by noise / power supply. Internal circuit is broken down.	Check the noise status around this device. Check the wiring status, supply voltage, and power supply capacity. When the synchronization + wire (orange) and synchronization - wire (orange / black) is extended with a cable other than exclusive cable, use a 0.2mm ² or more shielded twisted pair cable. If this device still does not work, confirm number of blinks of the error indicator and call to our local office.

<Digital error indicator “ \bar{E} ” lights up>

Cause	Remedy
Synchronization + wire (orange) or synchronization - wire (orange / black) error. Synchronization + wire (orange) or synchronization - wire (orange / black) comes down or short-circuits.	Connect synchronization + wire (orange) or synchronization - wire (orange / black) properly. Refer to “ 2-5 Wiring. ”
Receiver error	Check the operation of the receiver side.

<Emission halt indicator (orange) lights up>

Cause	Remedy	
Emission is in halt condition (Device error or interlock setting error)	Error indicator (yellow) lights or blinks.	Check the contents of the digital error indicator.
	Emission halt input / reset input wire (pink) is open when selecting auto-reset.	Wire the emission halt input / reset input (pink) wire to 0V or +V. Refer to “ 2-5 Wiring. ”
	Emission halt input / reset input wire (pink) is connected to 0V or +V when selecting manual reset.	Open the emission halt input / reset input (pink) wire. Refer to “ 2-5 Wiring. ”

<All beam-axis adjustment indicators (red) light up>

Cause	Remedy
The beam channel with its fixed blanking function set into valid receives light.	Turn ON the power supply after checking the installation status.

<Operation indicator remains lit in red (light is not received) (Note)>

Cause	Remedy
The beam channels are not correctly aligned.	Align the beam channels. Refer to “ 2-6 Adjustment. ” Align the top / bottom direction of the beam channel between emitter and receiver.
Sensing range is shortened because of the emission amount control function.	Reset to factory default (CLR) by the handy controller (SE9Z-HC) (optional).

Note: Since the color of the operation indicator changes according to ON / OFF status of the control output (OSSD 1 / 2), the operation indicator is marked as “OSSD” on the device.

If the device does not work normally after checking the items above, please consult IDEC.

<Reference>

About counting blinks of the error indicator, count blinks from 2 seconds of no blinking.

5-2 Troubleshooting of Receiver

<All indicators are OFF>

Cause	Remedy
Power is not being supplied.	Check that the power supply capacity is sufficient. Connect the power supply correctly.
Supply voltage is out of the specified range.	Set the supply voltage correctly.
Connector is not connected securely.	Connect the connector securely.

<Fault indicator (yellow) lights or blinks>

Cause	Remedy	
[Digital error indicator: 1] Setting data error of this device	Series connection is incorrect.	Check that the cable for series connection does not short-circuit, or is connected to the correct position (emitter for emitter, receiver for receiver). In case the handy controller (SE9Z-HC) (optional) is applied, reset the function.
	Noise is out of the specified range.	Check the noise status around this device. In case the handy controller (SE9Z-HC) (optional) is applied, reset the function.
	Internal error	Replace this device.
[Digital error indicator: 2] System error between emitter and receiver	Systems are different between emitter and receiver.	Set the same value to the numbers of emitter and receiver and that of beam channel, and the shield wires.
[Digital error indicator: 3] Series connection error	The serial signal short-circuits or comes down.	Check if the end cap has been fitted properly. Check that the cable for series connection does not short-circuit, or is connected to the correct position (emitter for emitter, receiver for receiver). Check the error contents of the device connected by the cable for series connection.
	Any of the main / sub sensor is in error.	
[Digital error indicator: 4] No. of total units / No. of total beam channels error	No. of total units / No. of total beam channels is out of the specified range.	Set the condition of the series connection within the specification. Refer to " 2-5-6 Series Connection. "
[Digital error indicator: 5] Extraneous light error	Extraneous light is entering or light from other model is entering.	When the power is ON, prevent any extraneous light from entering the receiver. If the extraneous light is coming from this device, conduct " 2-3-4 Device Placement " or " 3-4 Interference Prevention Function. "
[Digital error indicator: 6] Control output (OSSD 1 / 2) error	Control output 1 (OSSD 1) wire (black) and control output 2 (OSSD 2) wire (white) short-circuits with 0V or +V.	Wire the control output 1 (OSSD 1) wire (black) or control output 2 (OSSD 2) wire (white) correctly. Refer to " 2-5 Wiring. " Current value should be within the specified control output 1 (OSSD 1) wire (black) or control output 2 (OSSD 2) wire (white). Refer to " 6-1 Specifications. "
	Control output 1 (OSSD 1) wire (black) or control output 2 (OSSD 2) wire (white) short-circuit respectively, or short-circuits with other I/O wires.	
	Excessive incoming current flows in the Control output 1 (OSSD 1) wire (black) and control output 2 (OSSD 2) wire (white).	
	Output polarity setting wire (shield) and control output 1 (OSSD 1) wire (black) and control output 2 (OSSD 2) wire (white) are not correctly wired.	
	Output circuit error	Output circuit is damaged. Replace this device.
[Digital error indicator: 7] Output polarity setting wire (shield) error	Output polarity setting wire (shield) comes down or short-circuits with other I/O wires. Output polarity setting wire (shield) connection of emitter / receiver is incorrect.	Wire the output polarity setting wire (shield) correctly. (0V: PNP output, +V: NPN output) Wire the output polarity setting wire (shield) of the receiver correctly.

Cause		Remedy	
[Digital error indicator: 7] External device error	When using safety relay	Relay contact is welded.	Replace the relay.
		Response time of the relay is slow.	Replace the relay with proper response time. Setting by the handy controller (SE9Z-HC) (optional) is also possible. Refer to “ 3-6 External Device Monitor Function. ”
		Contacting point “b” of the relay is not wired.	Wire correctly to the relay.
	When setting the external device monitor function to “invalid.”	Auxiliary output wire (yellow-green / black) and external device monitor input wire (yellow-green) are not wired.	Connect the auxiliary output wire (yellow-green / black) and the external device monitor input wire (yellow-green). Set the external device monitor function to “invalid” using the handy controller (SE9Z-HC) (optional).
		Auxiliary output is not correctly operated.	Check if the auxiliary output wire (yellow-green / black) is disconnected or short-circuited. Reset to factory default (mode 0) by the handy controller (SE9Z-HC) (optional).
Bottom cap cables are adversely connected between emitter and receiver.	Check the connecting locations of the bottom cap cables.		
[Digital error indicator: 8] Effect from noise / power supply or failure of internal circuit	Affected by noise / power supply. Internal circuit is broken down.	Check the noise status around this device. Check the wiring status, supply voltage, and power supply capacity. When the synchronization + wire (orange) and synchronization - wire (orange / black) is extended with a cable other than exclusive cable, use a 0.2mm ² or more shielded twisted pair cable. If this device still does not work, confirm number of blinks of the error indicator and call to our local office.	

<Digital error indicator “ 9 ” lights up>

Cause	Remedy
Synchronization + wire (orange) or synchronization - wire (orange / black) error. Synchronization + wire (orange) or synchronization - wire (orange / black) comes down or short-circuits.	Connect synchronization + wire (orange) or synchronization - wire (orange / black) properly. Refer to “ 2-5 Wiring. ”
Emitter error	Check the operation of the emitter side.

<All beam-axis adjustment indicators (red) light up>

Cause	Remedy
The beam channel with its fixed blanking function set into valid receives light.	Turn ON the power supply after checking the installation status.

<OSSD indicator remains lit in red (light is not received)>

Cause	Remedy
The beam channels are not correctly aligned.	Align the beam channels. Refer to “ 2-6 Adjustment. ” Align the top / bottom direction of the beam channel between emitter and receiver.

If the device does not work normally after checking the items above, please consult IDEC.

<Reference>

About counting blinks of the error indicator, count blinks from 2 seconds of no blinking.

Chapter 6 Specifications / Dimensions

6-1 Specifications

Model

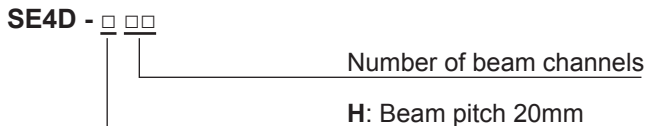

Example: **SE4D-H12**

Beam pitch: 20mm

Number of beam channels: 12 channels

Model-wise specifications

<20mm pitch type>

Type		20mm pitch type					
Item	Model No.	SE4D-H12	SE4D-H16	SE4D-H20	SE4D-H24	SE4D-H28	SE4D-H32
No. of beam channels		12	16	20	24	28	32
Sensing range		0.3 to 9m					
Beam pitch		20mm					
Protective height		230mm	310mm	390mm	470mm	550mm	630mm
Current consumption		Emitter: 70mA or less, Receiver: 95mA or less			Emitter: 80mA or less, Receiver: 115mA or less		
PFHd		1.8×10^{-9}	2.0×10^{-9}	2.2×10^{-9}	2.4×10^{-9}	2.6×10^{-9}	2.8×10^{-9}
MTTFd		More than 100 years					
Weight (total of emitter and receiver)		Approx. 510g	Approx. 660g	Approx. 810g	Approx. 960g	Approx. 1,110g	Approx. 1,260g

Type		20mm pitch type					
Item	Model No.	SE4D-H36	SE4D-H40	SE4D-H48	SE4D-H56	SE4D-H64	SE4D-H72
No. of beam channels		36	40	48	56	64	72
Sensing range		0.3 to 9m					0.3 to 7m
Beam pitch		20mm					
Protective height		710mm	790mm	950mm	1,110mm	1,270mm	1,430mm
Current consumption		Emitter: 80mA or less Receiver: 115mA or less	Emitter: 90mA or less Receiver: 140mA or less		Emitter: 100mA or less Receiver: 160mA or less		Emitter: 110mA or less Receiver: 180mA or less
PFHd		3.0×10^{-9}	3.2×10^{-9}	3.6×10^{-9}	4.0×10^{-9}	4.4×10^{-9}	4.8×10^{-9}
MTTFd		More than 100 years					
Weight (total of emitter and receiver)		Approx. 1,420g	Approx. 1,570g	Approx. 1,870g	Approx. 2,170g	Approx. 2,470g	Approx. 2,770g

Type		20mm pitch type		
Item	Model No.	SE4D-H80	SE4D-H88	SE4D-H96
No. of beam channels		80	88	96
Sensing range		0.3 to 7m		
Beam pitch		20mm		
Protective height		1,590mm	1,750mm	1,910mm
Current consumption		Emitter: 110mA or less Receiver: 180mA or less	Emitter: 120mA or less Receiver: 200mA or less	
PFHd		5.2×10^{-9}	5.6×10^{-9}	6.0×10^{-9}
MTTFd		More than 100 years		
Weight (total of emitter and receiver)		Approx. 3,070g	Approx. 3,370g	Approx. 3,670g

PFHd: Probability of dangerous failure per hour, MTTFd: Mean time to dangerous failure.

Common specifications

Type	20mm pitch type
Item Model No.	SE4D-H□
Detecting capability (Min. sensing object)	ø25mm opaque object
Effective aperture angle (EAA)	±2.5 degree or less [for sensing range exceeding 3m (Required by IEC 61496-2, ANSI/UL 61496-2)]
Supply voltage	24V DC±10% Ripple P-P10% or less
Control output (OSSD 1 / 2)	PNP open-collector / NPN open-collector transistor (switching type)
	<p><For PNP output></p> <ul style="list-style-type: none"> • Maximum source current: 200mA • Applied voltage: Same as supply voltage (between the control output and +V) • Residual voltage: 2.5V or less (source current 200mA, when using 15m length cable) • Leakage current: 0.1mA or less (Including power supply OFF condition) • Maximum load capacity: 0.22μF (No load to maximum output current) • Load wiring resistance: 3Ω or less
	<p><For NPN output></p> <ul style="list-style-type: none"> • Maximum sink current: 200mA • Applied voltage: Same as supply voltage (between the control output and 0V) • Residual voltage: 2.5V or less (sink current 200mA, when using 15m length cable) • Leakage current: 0.1mA or less (Including power supply OFF condition) • Maximum load capacity: 0.22μF (No load to maximum output current) • Load wiring resistance: 3Ω or less
Operation mode (Output operation)	ON when all beams are received, OFF when one or more beams are interrupted (Note 1, 2) (OFF when fault occurs in the sensor to the synchronization single error, too)
Protection circuit (Short-circuit)	Incorporated
Response time	In normal operation...OFF response: 14ms or less, ON response: 80 to 90ms
Auxiliary output (Non-safety output)	PNP open-collector transistor / NPN open-collector transistor (switching type)
	<p><For PNP output></p> <ul style="list-style-type: none"> • Maximum source current: 60mA • Applied voltage: Same as supply voltage (between the auxiliary output and +V) • Residual voltage: 2.5V or less (source current 60mA, when using 15m length cable)
	<p><For NPN output></p> <ul style="list-style-type: none"> • Maximum sink current: 60mA • Applied voltage: Same as supply voltage (between the auxiliary output and 0V) • Residual voltage: 2.5V or less (sink current 60mA, when using 15m length cable)
Operation mode (Output operation)	When OSSDs are ON: OFF, when OSSDs are OFF: ON (factory setting) [Changeable by using the handy controller (SE9Z-HC) (optional).]
Protection circuit (Short-circuit)	Incorporated
Protection	IP65 and IP67(IEC60529)
Degree of pollution	3
Ambient temperature	-10 to +55°C(No dew condensation of icing allowed), Storage:-25 to +70°C
Ambient humidity	30 to 85%RH, Strage: 30 to 95%RH
Ambient illuminance	Incandescent lamp: 3,500lx or less at the light-receiving surface
Operating altitude	2,000m or less
Voltage withstandability	1,000V AC for one min. (between all supply terminals connected together and enclosure)
Insulation resistance	20MΩ or more with 500V DC mega (between all supply terminals connected together and enclosure)
Vibration resistance	10 to 55Hz frequency, 0.75mm amplitude in X, Y, and Z directions for two hours each
Shock resistance	300m/s ² acceleration (Approx. 30G) in X, Y and Z directions for three times each
SFF (Safe failure fraction)	99%
HFT (Hardware fault tolerance)	1
Subsystem Type	Type B (IEC 61508-2)
Mission time	20 years
Emitting element	Infrared LED (Peak emission wavelength: 870nm)
Connection method	Connection with connectors
Material	Enclosure: Aluminum, Upper / lower case: SPCC, Sensing surface: PC / Polyester resin, Cap: PBT
Accessory	SE9Z-SED-2 (Intermediate supporting bracket): (Note 3) SE9Z-TR25 (Test rod): 1
Applicable standard	EN 61496-1 (Type 4), EN 55011, EN 61000-6-2, EN 50178, EN ISO 13849-1 (Category 4,PLe) IEC 61496-1/2 (Type 4) ISO 13849-1 (Category 4, PLe), IEC 61508-1 to 7 (SIL3) JIS B 9704-1/2 (Type 4), JIS B 9705-1 (Category 4), JIS C 0508 (SIL3) ANSI/UL 61496-1/2 (Type 4), UL 1998 (Class 2)

Notes: 1) The beam channel is not turned OFF during muting even if it is blocked.

2) In case the blanking function is valid, the operation mode is changed.

3) The intermediate supporting bracket (**SE9Z-SED-2**) is enclosed with the following devices. The quantity of the enclosed bracket differs depending on the device as follows:

1 set: 40 to 56 beam channels

2 sets: 64 to 80 beam channels

3 sets: 88 to 96 beam channels

⚠ WARNING

This device enables to set each function by using the handy controller (**SE9Z-HC**) (optional). Among the functions, the contents related to the safety distance such as the size of the minimum sensing object are varied depending on the setting condition. When setting each function, re-calculate the safety distance, and make enough space larger than the calculated safety distance. Failure to do so might cause the accident that the device cannot stop quickly before reaching the dangerous area of the device, resulting in the death or serious injury.

<Reference>

Refer to “**3-9 Functions Using Handy Controller (SE9Z-HC) (Optional)**” for details related to the function setting, or to the instruction manual attached to handy.

⚠ WARNING

Both emitter and receiver are adjusted before shipment, please apply both emitter and receiver with the same serial No. The serial No. is indicated on the plates of both emitter and receiver. (Under the model represents the serial No.)

6-2 Options

- 8-core bottom cap cable: 2 pcs./set

<Discrete wire>

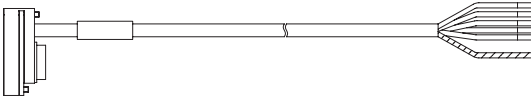

Type	Model No.	Cable length	Remarks
Discrete wire	SE9Z-CCB3	3m	This cable is used for normal operation.
	SE9Z-CCB7	7m	
	SE9Z-CCB10	10m	
	SE9Z-CCB15	15m	

- 12-core bottom cap cable: 2 pcs./set

<Discrete wire>

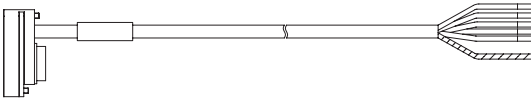

Type	Model No.	Cable length	Remarks
Discrete wire	SE9Z-CCB3-MU	3m	This 12-core bottom cap cable is used when the muting function is applied.
	SE9Z-CCB7-MU	7m	

- Cable for series connection: 2 pcs./set



Model No.	Cable length	Remarks
SE9Z-CSL05	0.5m	This cable is used for connecting the devices in series. Common for emitter and receiver.

- **Standard mounting bracket**
: 4 pcs./set

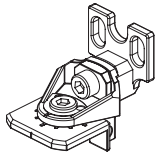

Model No.	Remarks
SE9Z-SED-1	This mounting bracket enables easy beam alignment. For two hexagon-socket head bolts [M5] or one hexagon-socket head bolt [M8].

- **M8 360°-rotatable mounting bracket**
: 4 pcs./set

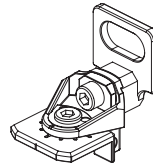

Model No.	Remarks
SE9Z-SED-1-T	This mounting bracket enables easy beam alignment. For one hexagon-socket head bolt [M8].

- **Dead zoneless mounting bracket: 4 pcs./set**

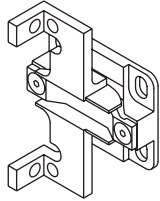

Model No.	Remarks
SE9Z-SED-3	This is the mounting bracket for reducing the dead space.

- **Handy controller: 1 pc.**

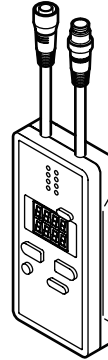

Model No.	Remarks
SE9Z-HC	Handy controller that enables setting each function.

6-3-2 Side Mounting with Standard Mounting Bracket (SE9Z-SED-1)

(Unit: mm)

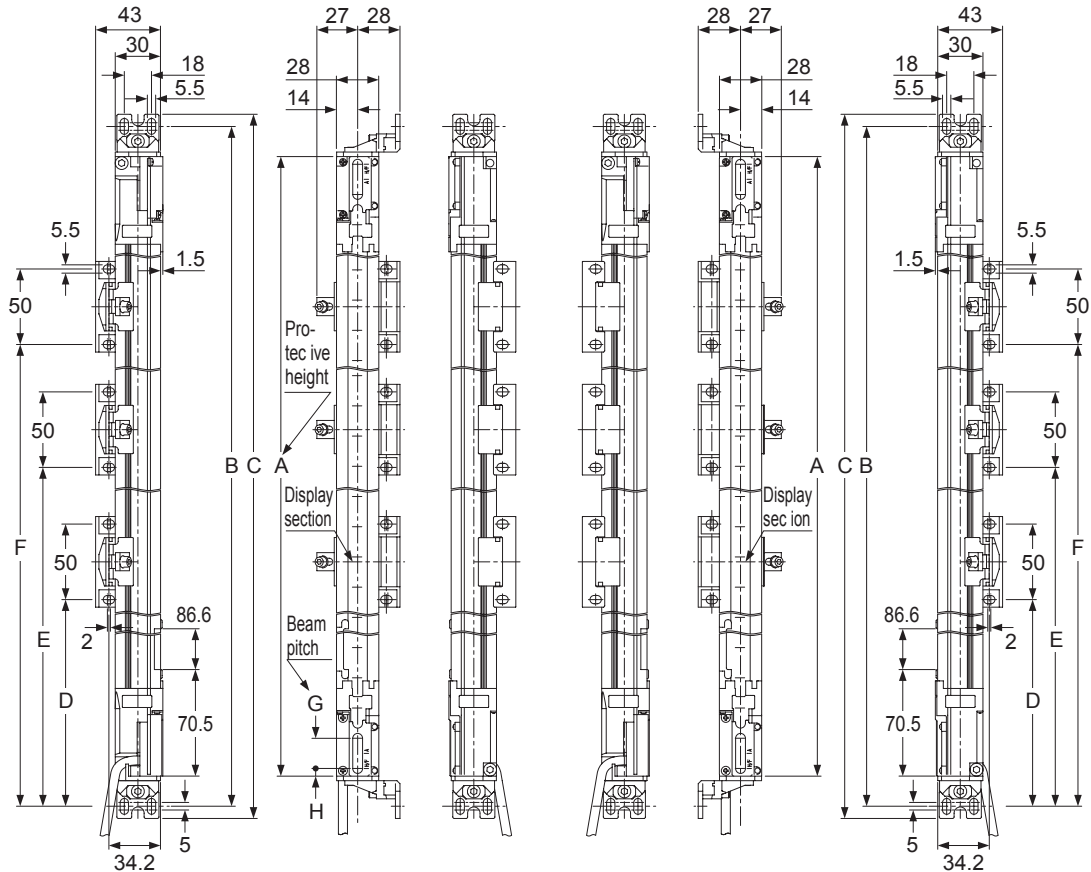

<Emitter>

<Receiver>

Model No.	A	B	C	D	E	F
SE4D-H12	230	270	286	-	-	-
SE4D-H16	310	350	366	-	-	-
SE4D-H20	390	430	446	-	-	-
SE4D-H24	470	510	526	-	-	-
SE4D-H28	550	590	606	-	-	-
SE4D-H32	630	670	686	-	-	-
SE4D-H36	710	750	766	-	-	-
SE4D-H40	790	830	846	390	-	-
SE4D-H48	950	990	1,006	470	-	-
SE4D-H56	1,110	1,150	1,166	550	-	-
SE4D-H64	1,270	1,310	1,326	418	842	-
SE4D-H72	1,430	1,470	1,486	472	948	-
SE4D-H80	1,590	1,630	1,646	525	1,055	-
SE4D-H88	1,750	1,790	1,806	433	870	1,308
SE4D-H96	1,910	1,950	1,966	473	950	1,428

Type	G	H
SE4D-H□	20	5

Note: The intermediate supporting bracket (SE9Z-SED-2) is enclosed with the devices.
The number of the brackets varies depending on the device.

6-3-3 Rear Mounting with Dead Zoneless Mounting Bracket (SE9Z-SED-3)

(Unit: mm)

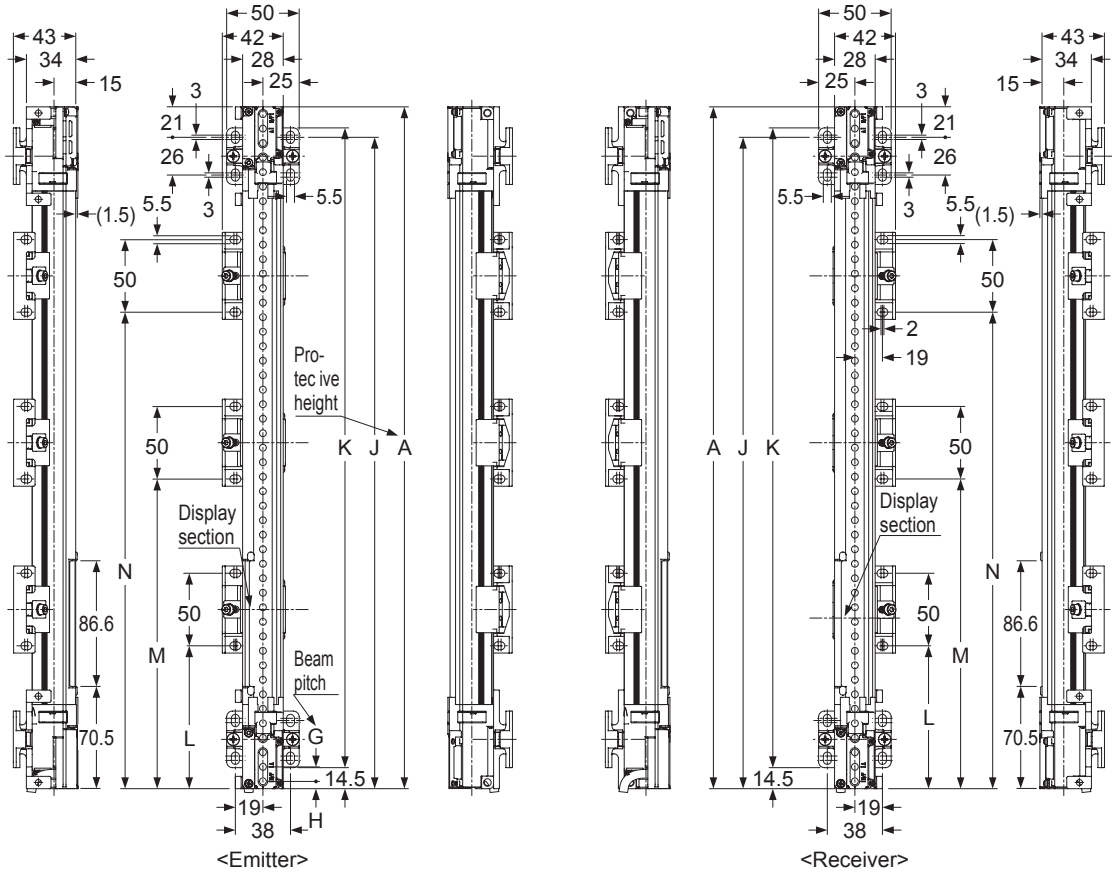

Model No.	A	J	K	L	M	N
SE4D-H12	230	209	201	-	-	-
SE4D-H16	310	289	281	-	-	-
SE4D-H20	390	369	361	-	-	-
SE4D-H24	470	449	441	-	-	-
SE4D-H28	550	529	521	-	-	-
SE4D-H32	630	609	601	-	-	-
SE4D-H36	710	689	681	-	-	-
SE4D-H40	790	769	761	370	-	-
SE4D-H48	950	929	921	450	-	-
SE4D-H56	1,110	1,089	1,081	530	-	-
SE4D-H64	1,270	1,249	1,241	398	822	-
SE4D-H72	1,430	1,409	1,401	452	928	-
SE4D-H80	1,590	1,569	1,561	505	1,035	-
SE4D-H88	1,750	1,729	1,721	413	850	1,288
SE4D-H96	1,910	1,889	1,881	453	930	1,408

Type	G	H
SE4D-H□	20	5

Note: The intermediate supporting bracket (SE9Z-SED-2) is enclosed with the devices.
The number of the brackets varies depending on the device.

6-3-4 Side Mounting with Dead Zoneless Mounting Bracket (SE9Z-SED-3)

(Unit: mm)

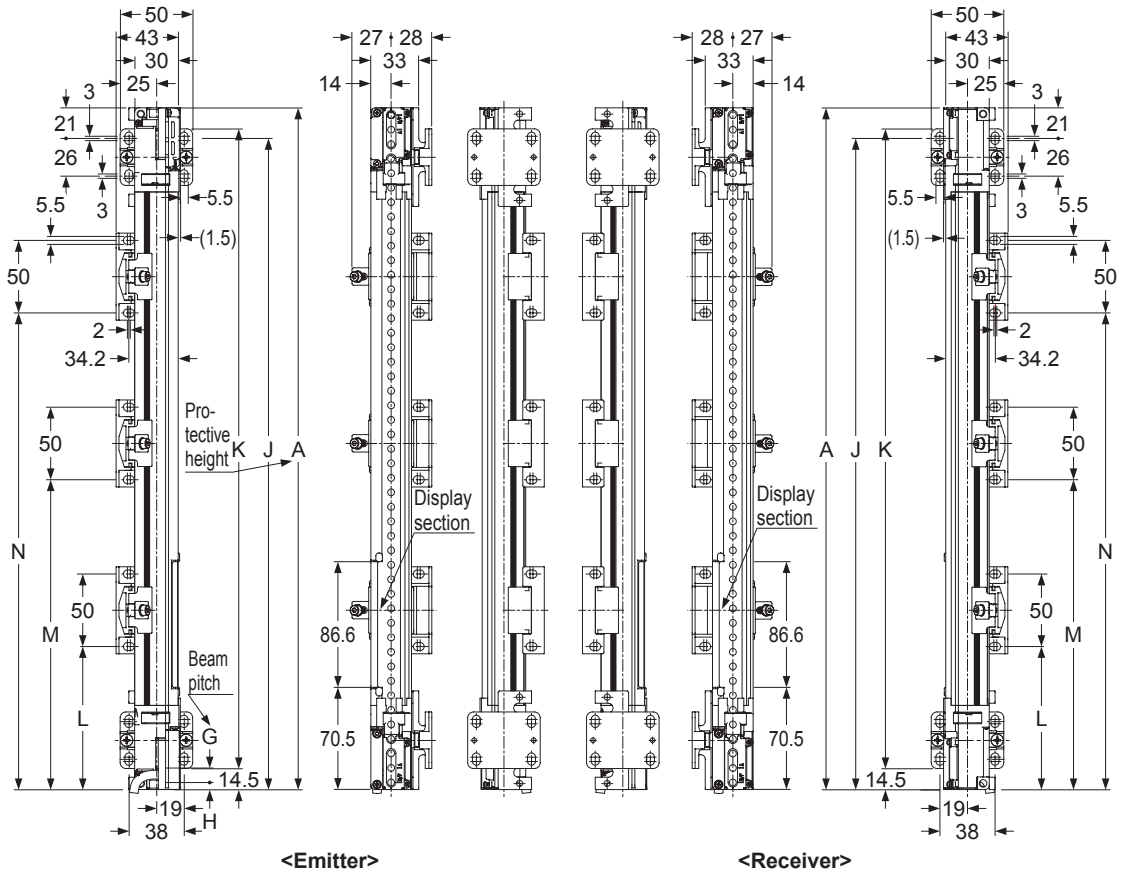

Model No.	A	J	K	L	M	N
SE4D-H12	230	209	201	-	-	-
SE4D-H16	310	289	281	-	-	-
SE4D-H20	390	369	361	-	-	-
SE4D-H24	470	449	441	-	-	-
SE4D-H28	550	529	521	-	-	-
SE4D-H32	630	609	601	-	-	-
SE4D-H36	710	689	681	-	-	-
SE4D-H40	790	769	761	370	-	-
SE4D-H48	950	929	921	450	-	-
SE4D-H56	1,110	1,089	1,081	530	-	-
SE4D-H64	1,270	1,249	1,241	398	822	-
SE4D-H72	1,430	1,409	1,401	452	928	-
SE4D-H80	1,590	1,569	1,561	505	1,035	-
SE4D-H88	1,750	1,729	1,721	413	850	1,288
SE4D-H96	1,910	1,889	1,881	453	930	1,408

Type	G	H
SE4D-H□	20	5

Note: The intermediate supporting bracket (SE9Z-SED-2) is enclosed with the devices.
The number of the brackets varies depending on the device.

6-3-5 Mounting Brackets

(Unit: mm)

1) Standard mounting bracket: SE9Z-SED-1

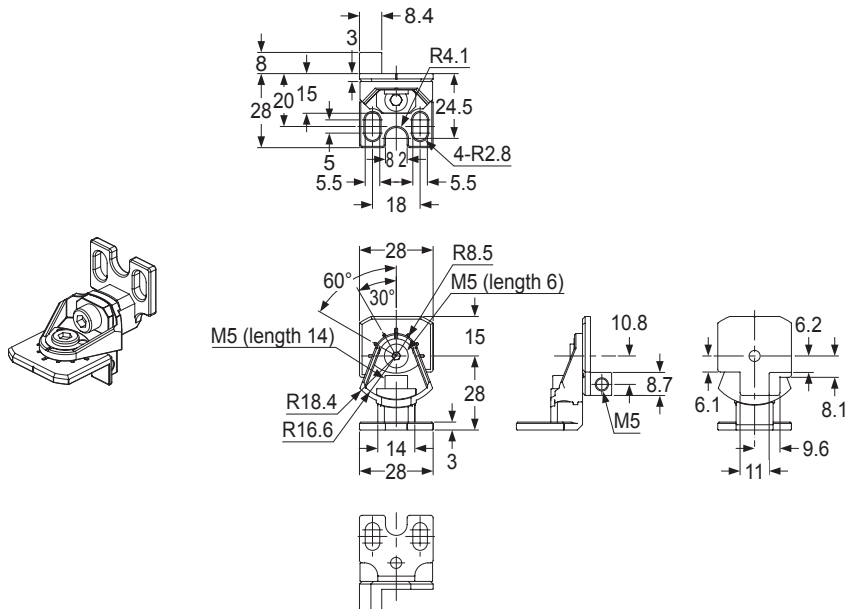

Material: Die-cast zinc alloy

2) M8 360°-rotatable mounting bracket: SE9Z-SED-1-T

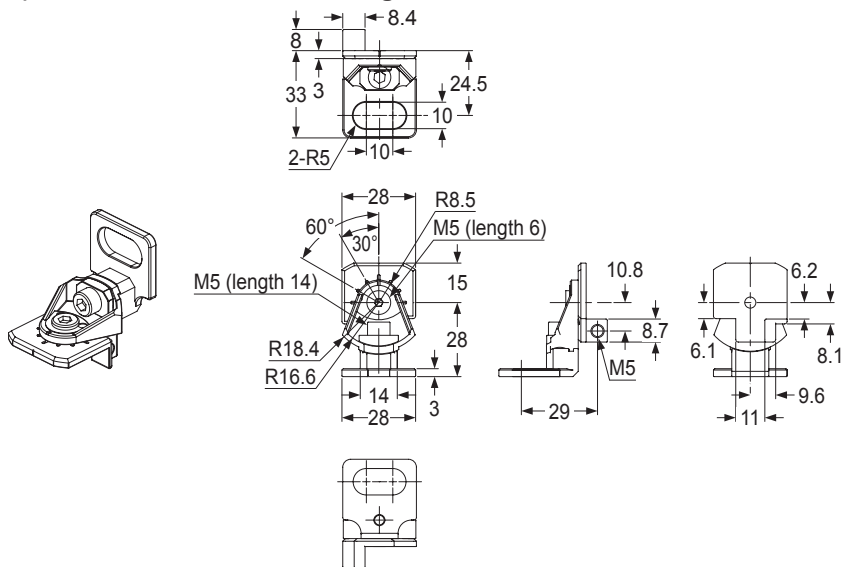

Material: Die-cast zinc alloy

3) Intermediate supporting bracket / SE9Z-SED-2

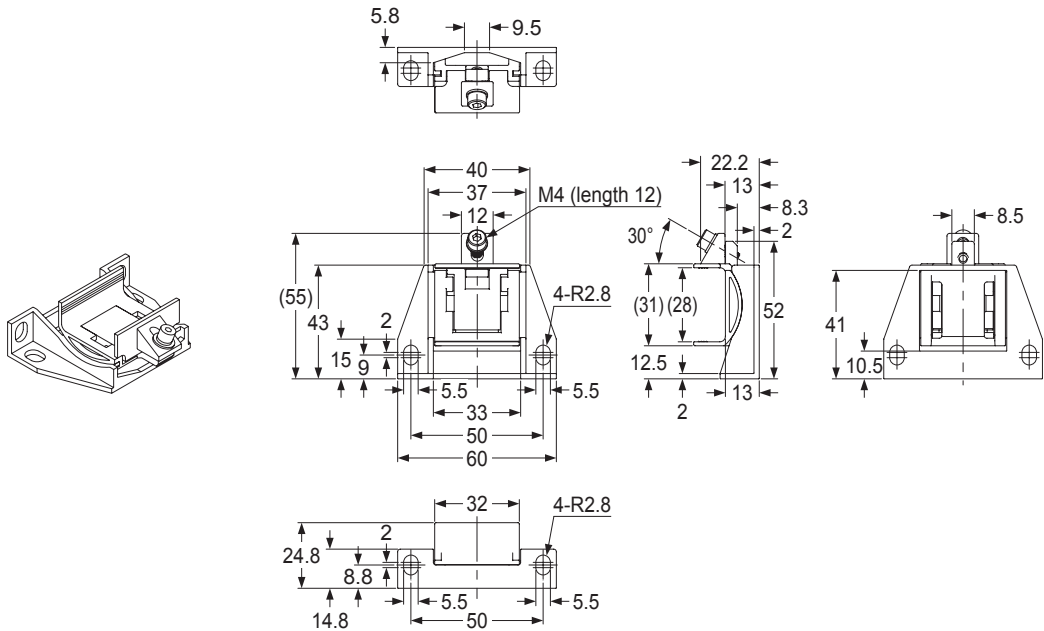

Material: Die-cast zinc alloy

4) Dead zoneless mounting bracket / SE9Z-SED-3

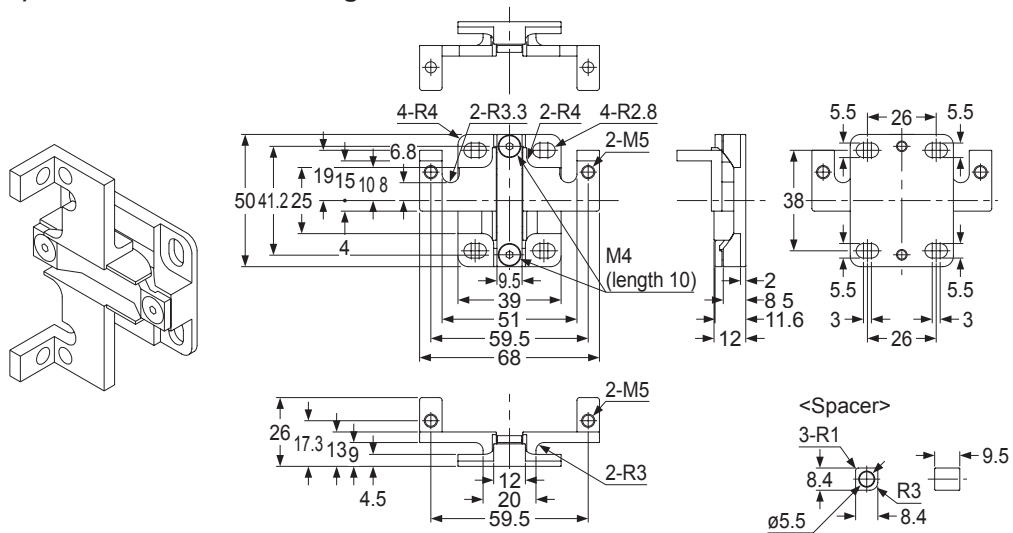

Material: Die-cast zinc alloy

Chapter 7 Others

7-1 Glossary

Machinery Directive	This directive is for an assembly of linked parts or components, energized by an electricity, compressed air or oil pressure, etc. and at least one of which moves, and a component which fulfills a safety function and is released into the market by itself.
EMC Directive	The directives is to any electric or electronic devices which will create more than a limited amount of RF interference, or will withstand a certain amount of Electro Magnetic fields while operating as intended within specifications.
EN 61496-1 IEC 61496-1/2 ANSI/UL 61496-1/2 JIS B 9704-1/2	The standards that pertain to machine safety, especially electro-sensitive protective equipment (ESPE). EN 61496-1, IEC 61496-1, ANSI/UL 61496-1 or JIS B 9704-1 gives general rules or failure mode and effect analysis, EMC requirements, etc. IEC 61496-2, ANSI/UL 61496-2 or JIS B 9704-2 specifies effective aperture angle, protection against extraneous light sources, etc, for Active Opto-electronic Protective Devices (AOPDs).
EN 55011	Specifies the limits and methods of measurement of radio disturbance characteristics of industrial, scientific and medical (ISM) radio-frequency equipment.
EN ISO 13849-1 ISO 13849-1 JIS B 9705-1	The standard that specifies the safety-related matters of machine safety / control system. They give roles for level (category) of structure and fault detection reliability, and for level of safety future performance capability (PL: Performance Level).
UL 1998	UL standard for safety-related software in programmable components.
ESPE	The abbreviation for Electro-Sensitive Protective Equipment.
Control output (OSSD)	The abbreviation for Output Signal Switching Device. A component of the light curtain that turns OFF when light of the light curtain is blocked.
FSD	The abbreviation for Final Switching Device. The component of the machine's safety related control system that open-circuits the MPCE circuit when the OSSD operates due to the light from the light curtain being blocked.
Test rod	This is a rod for checking the detection capability of this device. It has dimensions corresponding to the minimum sensing object for this device.
Main sensor / Sub sensor	For series connection, the sensor to which the power supply or the output is connected is called main sensor, and the others are called sub sensor.
Master side / Slave side	For parallel connection, the side where the emission / reception process timings are controlled is called master side, and the others are called slave side.
Lockout	It is one of the safe status of this device. Operation is stopped if the self-diagnosis function determines that an irrecoverable failure (OSSDs do not operate normally, etc.) has occurred. If an emitter is in lockout condition, it will stop emitting light. If a receiver is in lockout condition, OSSDs are turned OFF.
Safety distance	It is the minimum distance that must be maintained between the light curtain and the dangerous parts of a machine so that the machine can be stopped before a human body or an object can reach the dangerous parts.
Sensing height (Protective height)	The length of the beam-axis direction that the min. sensing object can be detected. The length from the center of the first beam channel to the center of the last beam channel in addition to +10mm (+5mm upward, +5mm downward).

Sensing range	It is the range between the facing emitter and receiver.
Sensing area	It is the area over which intrusion by people or objects can be detected by one set of the device. It is given by multiplying the sensing height (protective height) by the sensing range.
Emission halt function	This function enables checking of the receiver operation by turning OFF light emission. It is possible to halt emission by keeping the terminal open, and to have normal emission by connecting it to 0V (+V for NPN output).
PSDI	The abbreviation for the Presence Sensing Device Initiation. The safety device that restarts automatically without any operation by the operator after the device detects danger status and halts for a while.

7-2 CE Marking Declaration of Conformity

EU Declaration of Conformity

Identification of the Product	Safety Light Curtain
Name and address of Manufacturer	Name and address of the authorized representative :
IDEC CORPORATION	IDEC ELEKTROTECHNIK GmbH
2-6-64 Nishimiyahara, Yodogawa-Ku, Osaka 532-0004 Japan	Heselstuecken 8, 22453 Hamburg, Germany

This declaration of conformity is issued under the sole responsibility of the manufacturer.

Object of the declaration : Series Name – SE4D Series
Model No. – Refer type label for details

The object of the declaration described above is in conformity with the relevant EU harmonization legislation :

2006/42/EC	Machinery Directive
2014/30/EU	EMC Directive
2011/65/EU	RoHS Directive

Applied Union harmonized legislation and references to the relevant harmonization standards used or references the other technical specifications in relation to which conformity is declared.

EN 61496-1:2013
EN ISO 13849-1:2008
EN55011:2009/A1:2010
EN 61000-6-2:2005
EN 50581:2012

Where applicable, the notified body (Identification No. 0123)
TÜV SÜD Product Service GmbH, Ridlerstrasse, 65-80339 München, Germany

Additional Information :

Revision History

First edition: December 1, 2011

Second edition: August 1, 2013

Third edition: May 25, 2015

Fourth edition: April 20, 2016

(MEMO)

(MEMO)

1. WARRANTIES:

- (1) Subject to the exclusions stated in 2 (EXCLUSIONS) herein below, IDEC warrants the Products to be free of defects in material and workmanship for a period of one (1) year from the date of shipment under normal usage in environments commonly found in manufacturing industry.
- (2) Any Products found to be defective must be shipped to IDEC with all shipping costs paid by Purchaser or offered to IDEC for inspection and examination. Upon examination by IDEC, IDEC will, at its sole discretion, repair or replace at no charge, or refund the purchase price of, any Products found to be defective.

2. EXCLUSIONS:

- (1) This warranty does not apply to defects resulting from any cause:
 - (i) which was due to abuse, misuse, mishandling, improper installation, improper interfacing, or improper repair by Purchaser;
 - (ii) which was due to unauthorized modification by Purchaser, in part or in whole, whether in structure, performance or specification;
 - (iii) which was not discoverable by a person with the state-of-the-art scientific and technical knowledge at the time of manufacture;
 - (iv) which was due to an operation or use by Purchaser outside of the limits of operation or environment specified by IDEC;
 - (v) which was due to normal wear and tear;
 - (vi) which was due to Force Majeure; and
 - (vii) which was due to any use or application expressly discouraged by IDEC in 4 (CAUTIONS FOR SAFE USE) hereunder.
- (2) This warranty extends only to the first purchaser for application, and is not transferable to any person or entity which purchased from such purchaser for application.

3. DISCLAIMERS

- (1) IDEC's sole obligation and liability under this warranty is limited to the repair or replacement, or refund of the purchase price, of a defective Product, at IDEC's option.
- (2) THE REPAIR, REPLACEMENT, OR REFUND IS THE EXCLUSIVE REMEDY OF THE PURCHASER, AND ALL OTHER WARRANTIES, EXPRESS OR IMPLIED, INCLUDING, WITHOUT LIMITATION, THE WARRANTIES OF MERCHANTABILITY, FITNESS FOR A PARTICULAR PURPOSE, AND NON-INFRINGEMENT OF PROPRIETARY RIGHTS, ARE HEREBY EXPRESSLY DISCLAIMED. IN NO EVENT SHALL IDEC AND ITS AFFILIATED ENTITIES BE LIABLE FOR DAMAGES IN EXCESS OF THE PURCHASE PRICE OF THE PRODUCTS, OR FOR ANY INDIRECT, INCIDENTAL, SPECIAL OR CONSEQUENTIAL DAMAGES OF ANY KIND, GENERAL TERMS AND CONDITIONS 4 OR ANY DAMAGES RESULTING FROM LOSS OF USE, BUSINESS INTERRUPTION, LOSS OF INFORMATION, LOSS OR INACCURACY OF DATA, LOSS OF PROFITS, LOSS OF SAVINGS, THE COST OF PROCUREMENT OF SUBSTITUTED GOODS, SERVICES OR TECHNOLOGIES, OR FOR ANY MATTER ARISING OUT OF OR IN CONNECTION WITH THE USE OR INABILITY TO USE THE PRODUCTS.

4. CAUTIONS FOR SAFE USE

- (1) The applications shown in the catalogue are only suggestions, and it is Purchaser's sole responsibility to ascertain the fitness and suitability of the Products for any particular application, as well as to abide by Purchaser's applicable local laws and regulations, if any.
- (2) Never use the Products NOT rated or designated as "SAFETY SENSOR" in any application involving risk to life or property. When such a use is made by Purchaser, such Purchaser shall indemnify and hold harmless IDEC from any liability or damage whatsoever arising out of or in relation to such use.
- (3) In incorporating the Products to any equipment, facilities or systems, it is highly recommended to employ fail-safe designs, including but not limited to a redundant +++design, flame propagation prevention design, and malfunction prevention design so as not to cause any risk of bodily injury, fire accident, or social damage due to any failure of such equipment, facilities or systems.
- (4) The Products are each intended for use only in environments commonly found in manufacturing industry, and, unless expressly allowed in the catalogue, specification or otherwise, shall not be used in, or incorporated into, any equipment, facilities or systems, such as those:
 - (a) which are used for the protection of human life or body parts;
 - (b) which are used outdoors or in environments subject to any likelihood of chemical contamination or electromagnetic influence;
 - (c) which are likely to be used beyond the limits of operations or environments specified by IDEC in the catalogue or otherwise;
 - (d) which may cause risk to life or property, such as nuclear energy control equipment, transportation equipment (whether on rail or land, or in air or at sea), and medical equipment;
 - (e) which are operated continuously each day for 24 hours; and
 - (f) which otherwise require a high level of safety performance similar to that required in those equipment, facilities or systems as listed in (a) through (e) above.

5. EXPORT CONTROL LAWS

In some jurisdictions, the Products may be subject to local export laws and regulations. If any diversion or re-export is to be made, Purchaser is advised to abide by such local export laws and regulations, if any, at its own responsibility.

IDEC CORPORATION

2 6 64 Nishimiyahara, Yodogawa Ku, Osaka 532 0004, Japan

IDEC ELEKTROTECHNIK GmbH

Heseltuecken 8, 22453, Hamburg, Germany
<http://www.idec.com>
