



INSTRUCTION SHEET

Original Instructions
Key Type Interlock Switch
HS5E-K Series



Thank you for purchasing this IDEC product. Confirm that the delivered product is what you have ordered. Read this instruction sheet to make sure of correct operation.

SAFETY PRECAUTIONS

In this operation instruction sheet, safety precautions are categorized in order of importance to Warning and Caution :

WARNING

Warning notices are used to emphasize that improper operation may cause severe personal injury or death.

CAUTION

Caution notices are used where inattention might cause personal injury or damage to equipment.

1 Type

Circuit Code			HS5E-K□0L03-2A501		
Main circuit	Door monitor circuit	Lock monitor circuit			
[A] : 1NC+1NC	1NO	1NO	To select key numbers Blank : 500 501 to 515 : 501 to 515		
[B] : 1NC+1NC	1NO	1NC	Key Retained at A : Lock and Unlock B : Unlock C : Lock		
[C] : 1NC+1NC	1NC	1NO	Cable Length [01] : 1m 03 : 3m 05 : 5m		
[D] : 1NC+1NC	1NC	1NC	For Rear Unlock Blank : Without Rear Manual Unlock L : Push Button		
[F] : 1NC+1NC	2NC	-	Indicator [4] : With Indicator 0 : Without Indicator		
[G] : 1NC+1NC	1NC,1NO	-	*1 Type Nos. in [] are not supplied as standard. Contact IDEC if required.		
[H] : 1NC+1NC	-	2NC			
[J] : 1NC+1NC	-	1NC,1NO			
[DD] : 1NC+1NC	-	-			
[DD] : 1NC+1NC	-	-			
VA : -	1NC,1NO	1NC,1NO			
[VB] : -	1NC,1NO	2NC			
[VC] : -	2NC	1NC,1NO			
VD : -	2NC	2NC			
[VF] : -	3NC	1NC			
[VG] : -	2NC,1NO	1NC			
[VH] : -	1NC	3NC			
[VJ] : -	1NC	2NC,1NO			

2 Specifications and Ratings

Applicable Standards	EN ISO / ISO14119 IEC60947-5-1, EN60947-5-1 GS-ET-19, UL508, CSA C22.2 No.14 GB/T 14048. 5				
Standards for Use	IEC60204-1/EN60204-1				
Interlocking device Type / the level of coded	Type 2 Interlocking device / low level coded actuator (EN ISO / ISO14119)				
Applicable Directives	Low Voltage Directive, Machinery Directive				
Operating Condition	Operating Temperature	HS5E-K□0(Without Indicator Type) -25 to +70°C (no freezing) HS5E-K□4(With Indicator Type) -25 to +55°C (no freezing)			
	Operating Humidity	45 to 85%RH (no condensation)			
	Storage Temperature	-40 to +80°C (no freezing)			
	Pollution Degree	3 (Inside2)			
	Altitude	2,000m maximum			
Impulse withstand voltage (Uimp)	2.5kV (Between ground and LED circuit : 0.5kV)				
Rated Insulation voltage (Ui)	250V (Between ground and LED circuit : 30V) *2				
Thermal Current (Ith)	2.5A				
Contact Ratings (Reference Values) (Ue, Ie)	AC	Resistive load (AC12)	30V	125V	250V
			-	2.5A	1.5A
		Inductive load (AC15)	-	1.5A	0.75A
			DC	Resistive load (DC12)	2.5A
Inductive load (DC13)	2.3A	0.55A	0.27A		
Class of Protection	ClassII (IEC61140) *3 □				
Operating Frequency	900 operations/hour				
Operating Speed	0.05 to 1.0 m/s				
B _{10d}	2,000,000 (EN ISO13849-1 Annex C Table C.1)				
Mechanical durability	1,000,000 operations min. (GS-ET-19) the Rear Unlock Button: 3,000 operations min. (Type HS5E-K□L)				
Electrical Durability	100,000 operations min. (AC-12 250V·1.5A) 1,000,000 operations min. (AC/DC 24V 100mA) (900 operations / hour)				

Shock Resistance	Operating extremes: 100 m/s ² , Damage limits: 1,000 m/s ²	
Vibration Resistance	Operating extremes: 10 to 55 Hz, amplitude 0.35 mm minimum Damage limits: 30 Hz, amplitude 1.5 mm minimum	
Actuator Tensile Strength when Locked	Fzh=1,400N minimum F1max.=1,820N minimum (GS-ET-19) *4, *5 (Fzh=500N minimum : HS9Z-A55 actuator)	
Direct Opening Travel	11 mm min. (actuator: HS9Z-A51,A5P) 12 mm min. (for other actuators)	
Direct Opening Force	80N min.	
Contact Resistance	500 mΩmax. (initial value, 3m cable)	
Degree of Protection	IP65 (IEC60529)	
Shock Resistance	Operating extremes: 100 m/s ² , Damage limits: 1000 m/s ²	
Vibration Resistance	Operating extremes: 10 to 55 Hz, amplitude 0.35 mm minimum Damage limits: 30 Hz, amplitude 1.5 mm minimum	
Short-circuit Protective Device	Use 250V / 10A fast acting type fuse *6	
Key	Operating Specifications	2 Positions
	Mechanical Durability	100,000 operations min.
	Key Operating Durability	10,000 operations min.
	Key Tensile Strength	1.0N·m min.
	Direct Opening Force	0.6N·m min.
Indicator	Direct Opening Degree	60° min.
	Rated Operating Voltage	24V DC
	Rated Current	10 mA
	Light Source	LED
illumination Color	Green	

Ratings approved by safety agencies

- (1) TÜV,CCC rating (2) UL , c-UL rating
 AC-15 250V/0.75A 1.5A, 125V ac, Pilot Duty
 DC-13 125V/0.22A 0.22A, 125V dc, Pilot Duty
 DC-13 30V/2.3A

*2 Ratings approved by UL,c-UL:125V

*3 Basic insulation of 2.5kV impulse withstand voltage is ensured between different contact circuits and between contact circuits and LED or solenoid in the enclosure. When both SELV (safety extra low voltage) or PELV (protective extra low voltage) circuits and other circuits (such as 230V AC circuits) are used for the solenoid power and contact circuits at the same time, the SELV or PELV requirements are not met any more.

*4 The actuator locking strength is rated at 1,400N of static load . Do not apply a load higher than the rated value. When a higher load is expected to work on the actuator, provide an additional system consisting of another interlock switch without lock (such as the HS5D interlock switch) or a sensor to detect door opening and stop the machine.

*5 F1max. is maximum force. The actuator's guard-locking force Fzh is calculated in accordance with GS-ET-19 :

$$F_{zh} = \frac{\text{maximum force (F1max.)}}{\text{Safety coefficient (=1.3)}}$$

*6 Make sure that a fast acting fuse for short-circuit protection trips before overheating of the wires.

3 Mounting Examples

- Install the interlock switch on the immovable machine or guard, and install the actuator on the movable door. Do not install both interlock switch and actuator on the movable door, otherwise the angle of insertion of the actuator to the safety switch may become inappropriate, and failure will occur.

(Examples of Mounting on Sliding Doors) (Examples of Mounting on Hinged Doors)

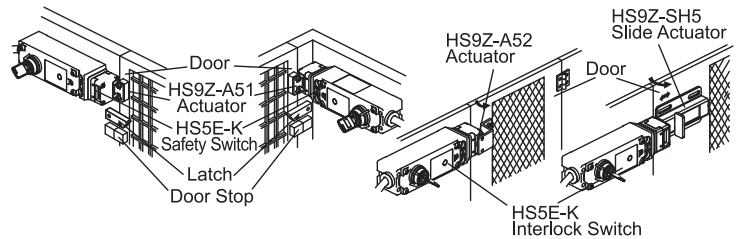

The HS5E-K Head

- Changing the Mounting Directions of the HS5E-K Head. The head of the HS5E can be mounted in four directions by removing the four screws from the corners of the HS5E-K head.

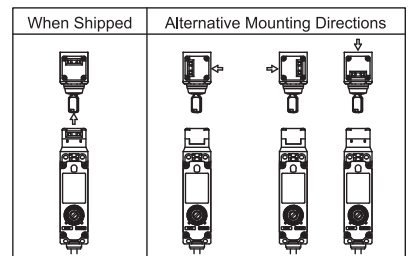

⚠ WARNING

Mounting Directions of the HS5E-K Head

- When replacing the HS5E-K head, make sure that no foreign object enters into the safety switch. Tighten the screws tightly, without leaving space between the head and body, otherwise the interlock switch may malfunction.
- Don't remove the screws of head expect when the mouting directions of head is changed.

Mounting the Head

- Do not use the plastic and metal head of the HS5D interlock switches. Be sure to use the metal head for the HS5E-K. When using these HS5D adjacently, ensure that the heads are not interchanged.

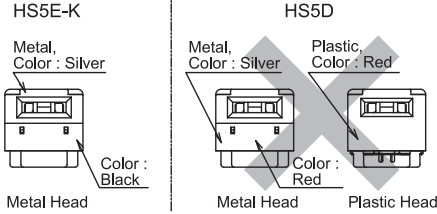

Head Removal Detection Function

When the key is operated, the operation of the main circuit (11-42)/monitor circuit (41-42) and monitor circuits (51-52, 61-62) are the same. However, when the head is removed, disparity is detected (11-42/41-42 : OFF, 51-52/61-62 : ON). The disparity of the contacts detects the removal of the head.

<p>■ : Contact Closed □ : Contact Open</p> <p>LOCK UNLOCK</p>	Actuator Unlocked	Actuator Locked	When the HS5E-K head is removed
Main Circuit: BU ⊙ 11 → 42 BU/WH			
Monitor Circuit: PK ⊙ 41 → 42 PK/WH			
Monitor Circuit: BN ⊙ 51 → 52 BN/WH			
Monitor Circuit: OG ⊙ 61 → 62 OG/WH			

Installing the Manual Rear Unlocking Button (Type HS5E-K□L)

- After installing the interlock switch on the panel, put the manual rear unlocking button (supplied) on the rod on the back of the interlock switch, and fasten using the mounting screw. When installing on the aluminum frame of the thickness of 6mm or more, use the rear unlocking button for frame kit (HS9Z-FL5□) sold separately.

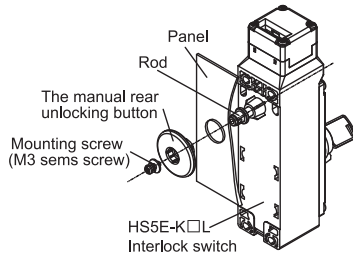

⚠ CAUTION

After installing the manual rear unlocking button, apply Loctite to the screw so that the screw does not become loose. The base is made of glass-reinforced PA66 (66 nylon). The mounting screw is iron. Take the compatibility of plastic material and Loctite into consideration.

Minimum Radius of Hinged Door

- When using the safety switch for a hinged door, the minimum radius of the applicable door is shown in the following figures.

When the center of the hinged door is on the extension line of the actuator mounting surface.

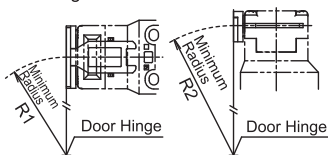

When the center of the hinged door is on the extension line of the contact surface of actuator and interlock switch.

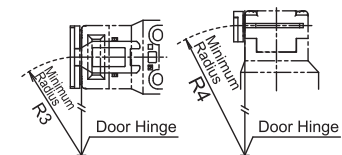

	Minimum Radius			
	R1	R2	R3	R4
HS9Z-A52	230 mm	260 mm	170 mm	190 mm
HS9Z-A52A	Mounting centers:12 mm	230 mm	120 mm	140 mm
	Mounting centers:20 mm	310 mm	170 mm	
HS9Z-A53		80 mm (Vertical Swing)		50 mm (Vertical Swing)
HS9Z-A55	70 mm (Horizontal Swing)	70 mm (Vertical Swing)	50 mm (Horizontal Swing)	50 mm (Vertical Swing)
HS9Z-A55S				

⚠ CAUTION

The values shown above are based on the condition that the actuator enters and exits the actuator entry slot smoothly when the door is closed or opened. Since there may be deviation or dislocation of the hinged door, make sure of correct operation in the actual application before installation.

Adjusting the Angle Adjustable (vertical/horizontal) Actuator (Type HS9Z-A53/A55/A55S)

- Using the angle adjustment screw (M3 hexagon socket set screw), the actuator angle can be adjusted up to 20°(refer to dimensions).
- The larger the actuator angle, the smaller the applicable radius of the door swing. After installing the actuator, open the door. Then adjust the actuator angle so that the actuator enters the entry slot of the interlock switch properly.
- After adjusting the actuator angle, apply loctite or the like on the adjustment screw to prevent loosening.

(Type HS9Z-A53)

Tightening torque of angle adjustment screw: 0.8 N·m.

(Type HS9Z-A55)

Use screw locking agent that is compatible with the base material.

Base: PA66 (66 nylon) of glass reinforced grade

Angle adjustment screws: stainless steel

(Type HS9Z-A55S)

Use screw locking agent that is compatible with the base material.

Plate: stainless steel

Base : PA66 (66 nylon) of glass reinforced grade

Angle adjustment screws : stainless steel

Actuator Mounting Reference Position

As shown below, the mounting reference position of the actuator inserted into the interlock switch is:

(Type HS9Z-A53)

The actuator stop film placed on the actuator touches the interlock switch lightly!

(Except Type HS9Z-A53)

The actuator and actuator cover touches the actuator stop placed on the interlock switch lightly.

(After mounting the actuator, remove the actuator stop from the interlock switch.)

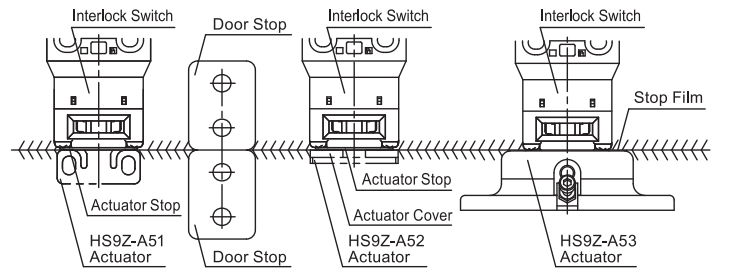

Actuator Mounting Tolerance

- Mounting tolerance of the actuator is 1.0mm in the four lateral directions.
- Make sure the actuator can be inserted into the entry slot without any issue.
- When closing the door, the actuator is inserted and locked within a certain distance from the reference position. After the actuator has been locked, the contact operation is not affected by the actuator movement in the locked state.

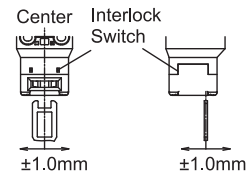

	(Actuator deviation) + (Door movement)
HS9Z-A51	≤ 3.3mm
HS9Z-A52	
HS9Z-A51A	≤ 4.6mm
HS9Z-A52A	
HS9Z-A53	≤ 5.6mm
HS9Z-A55	≤ 4.6mm
HS9Z-A55S	

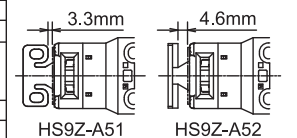

For Type HS9Z-A51A/A52A actuator

- When there is a displacement of safety switch and actuator, the actuator may hit the entry slot of safety switch hardly, thus damaging the entry slot and actuator. The rubber cushions on the HS9Z actuator prevent the actuator from damaging the entry slit by absorbing the shock with movement flexibility. Do not, however, exert excessive shocks, otherwise the failure of interlock switch may be caused.
- The rubber cushions may deteriorate depending on the operating environment and conditions. Immediately replace the deformed or cracked rubber cushions with new ones.

Recommended Screw Tightening Torque

Name or Use	Screw Tightening Torque
For mounting the interlock switch (M4 screw) *7	1.8 to 2.2 N•m
For mounting the actuator (HS9Z-A51: two M4 screws) *7	1.8 to 2.2 N•m
(HS9Z-A52: two M4 Phillips screws)	0.8 to 1.2 N•m
(HS9Z-A51A/A52A: two M4 screws) *7*8	1.0 to 1.5 N•m
(HS9Z-A53: two M6 screws) *7	4.5 to 5.5 N•m
(HS9Z-A55/A55S: two M4 screws) *7	1.0 to 1.5 N•m
For mounting the HS5E-K head (M3)	0.9 to 1.1 N•m
For mounting the manual rear unlocking button(M3 sems screw)	0.5 to 0.7 N•m

CAUTION

*7 The above recommended tightening torques of the mounting screws are the values confirmed with hex socket head bolts. When other screws are used and tightened to a smaller torque, make sure that the screws do not come loose after mounting.

*8 In the case of HS9Z-A51A and HS9Z-A52A, using two M4 screws and two attached washers, fasten the actuator securely on the door.

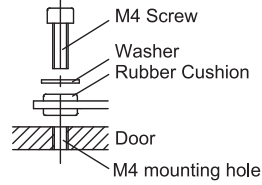

Installing the slot plug (In the case of a standard sale model. Please check other models.)

- When not in use, close up the interlock switch actuator entry slots with slot plugs to prevent dust from entering.
- The actuator entry slot vertical to the mounting panel come closed up with slot plugs at time of shipment. When replacing, please use the tool as shown and replace it.

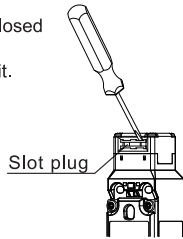

4 Precautions for Operation

For Mounting

- Do not apply an excessive shock to the safety switch when opening or closing the door. A shock to the interlock switch exceeding 1,000 m/s may cause failure.
- Provide a door guide, and ensure that force is applied on the safety switch only in the actuator insertion direction.
- Do not pull the actuator while it is locked. Also, regardless of door types, do not use the interlock switch as a door lock. Install a separate lock as shown in 3.
- Do not open the lid ① of the switch. Loosening the screws may cause damage to the switch.
- Entry of foreign objects in the actuator entry slot may affect the mechanism of the switch and cause a breakdown. If the operating atmosphere is contaminated, use a protective cover to prevent the entry of foreign objects into the switch through the actuator entry slots.
- Make sure to install the product in a place where it cannot be damaged. Make sure to conduct a proper risk assessment evaluation before using the product, and use a shield or a cover to protect the product if need be.
- Do not fasten and loosen the conduit at the bottom of the interlock switch.
- When wiring, make sure that liquid such as water and oil does not intrude from the tip of cable.
- When bending the cable during wiring, secure the cable radius of 30mm at the minimum.
- Use the dedicated actuators only. Other actuators will cause damage to the switch.

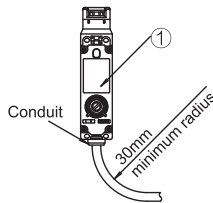

WARNING

- Turn off the power to the safety switch before starting installation, removal, wiring, maintenance, and inspection on the safety switch. Failure to turn power off may cause electrical shocks or fire hazard.
- Do not disassemble or modify the switch. Also do not attempt to disable the interlock switch function, otherwise a breakdown or an accident will result.

CAUTION

- Regardless of door types, do not use the safety switch as a door stop. Install a mechanical door stop to the end of the door to protect the safety switch against excessive force.
- Mount the actuator so that it will not hit the operator when the door is open, otherwise injury may be caused.
- Turn off the power to the safety switch before starting installation, removal, wiring, maintenance, and inspection on the safety switch. Failure to turn power off may cause electrical shocks or fire hazard.
- Mount the actuator so that it will not hit the operator when the door is open, otherwise injury may be caused.
- Pay attention to the management of spare actuator. Safety function of door interlock switch will be lost in case the spare actuator is inserted into the interlock switch. Ensure that the actuator is firmly fastened to the door (welding, rivet, special screw) in the appropriate location, so that the actuator cannot be removed easily.
- Do not cut or remodel the actuator, otherwise failure will occur.
- If multiple safety components are wired in series, the Performance Level to EN ISO13849-1 will be reduced due to the restricted error detection under certain circumstance.
- The entire concept of the control system, in which the safety component is integrated, must be validated to EN ISO13849-2.

- Do not mount the interlock switch facing down as shown in the figure on the right. The key may fall due to vibration.

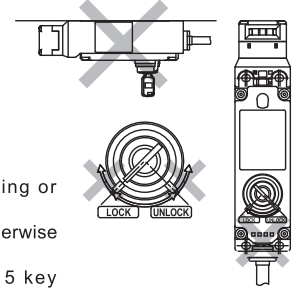

Key

- Be sure to take the following precautions. Otherwise, failure or damage may occur.
- When using the key, insert the key all the way.
- Do not apply a rotative force when inserting or removing the key.
- Also, do not pull the key during operation. Otherwise failure or damage may occur.
- Other than the standard key, there are 15 key variations. Be sure to use a key and cylinder with the same number.
- Do not apply excessive force to the key. Otherwise failure or damage may occur.
- With the key in the UNLOCK position, do not turn the key to the LOCK position with the actuator removed (door open). Otherwise failure or damage may occur.

For the Rear Unlock Button (Type HS5E-K□L)

- The rear unlock button is used for an emergency escape when the worker is confined in the safety hedge (the dangerous area). (The rear unlock button is according to EN ISO / ISO14119 (2013) ,GS-ET-19)
- The lock is released when the rear unlock button is pressed, and the door can be opened.
- To return to locked status, pull back the button. While the Rear Unlock Button is depressed, the main circuit remains open and the door is unlocked.

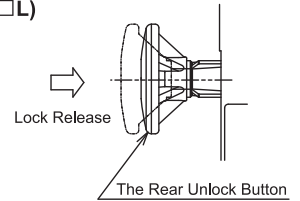

CAUTION

- Install the HS5E-K to ensure that a worker can operate the rear unlock button from inside the safety hedge (the dangerous area). It is dangerous to install the HS5E-K in the position where the rear unlock button can be operated from outside the the safety hedge (the dangerous area), because it is possible to unlock while the machine is operating.
- Use hand to press the button, and do not use a tool. Do not apply excessive force to the rear unlock button.

Using the HS5E-K in an explosive atmosphere

- By using the HS5E-K with an explosion-proof cover (HS9Z-BC51, optional) or a door handle actuator (HS9Z-DH□, optional), and connecting the EB3N safety relay barrier (EB3N-□□, optional), the HS5E-K can be used as an intrinsically safe explosion-proof product.
- When using in an explosive atmosphere, see the EB3N safety relay instruction manual or the user's manual.
- For operating conditions of the explosion-proof cover, see the instruction manual supplied with the explosion-proof cover.

5 Contact Operation

Contact Configuration and Operation

Type *10	Contact Configuration *11	Contact Operation (reference)
		0 (Actuator Mounting Reference Position) (Travel: mm) Approx. 3.3 (Lock) Approx. 5.3 Approx. 6.9 Approx. 26.4
[HS5E-KA□]	Main Circuit: 11-12, 23-24, 53-54 Monitor Circuit: 41-42, 51-52	11-42, 23-24, 53-54, 41-42, 51-52
[HS5E-KB□]	Main Circuit: 11-12, 23-24, 51-52 Monitor Circuit: 41-42, 53-54	11-42, 23-24, 51-52, 41-42, 53-54
[HS5E-KC□]	Main Circuit: 11-12, 21-22, 53-54 Monitor Circuit: 41-42, 51-52	11-42, 21-22, 53-54, 41-42, 51-52
[HS5E-KD□]	Main Circuit: 11-12, 21-22, 51-52 Monitor Circuit: 41-42, 53-54	11-42, 21-22, 51-52, 41-42, 53-54
[HS5E-KF□]	Main Circuit: 11-12, 21-22, 31-32 Monitor Circuit: 41-42, 53-54	11-42, 21-22, 31-32, 41-42, 53-54
[HS5E-KG□]	Main Circuit: 11-12, 21-22, 33-34 Monitor Circuit: 41-42, 53-54	11-42, 21-22, 33-34, 41-42, 53-54
[HS5E-KH□]	Main Circuit: 11-12, 41-42, 51-52, 61-62 Monitor Circuit: 11-12, 21-22, 31-32, 41-42, 51-52, 61-62	11-42, 51-52, 61-62, 11-12, 21-22, 31-32, 41-42, 51-52, 61-62
[HS5E-KJ□]	Main Circuit: 11-12, 41-42, 51-52, 63-64 Monitor Circuit: 11-12, 21-22, 31-32, 41-42, 51-52, 63-64	11-42, 51-52, 63-64, 11-12, 21-22, 31-32, 41-42, 51-52, 63-64
[HS5E-KDD□]	Main Circuit: 11-12, 21-22, 51-52 Monitor Circuit: 41-42, 53-54	11-42, 21-22, 51-52, 41-42, 53-54
HS5E-KVA□	Monitor Circuit: 11-12, 23-24, 53-54	11-12, 23-24, 41-42, 53-54
[HS5E-KVB□]	Monitor Circuit: 11-12, 23-24, 51-52	11-12, 23-24, 41-42, 51-52
[HS5E-KVC□]	Monitor Circuit: 11-12, 21-22, 53-54	11-12, 21-22, 41-42, 53-54
HS5E-KVD□	Monitor Circuit: 11-12, 21-22, 51-52	11-12, 21-22, 41-42, 51-52
[HS5E-KVF□]	Monitor Circuit: 11-12, 21-22, 31-32	11-12, 21-22, 31-32, 41-42, 53-54
[HS5E-KVG□]	Monitor Circuit: 11-12, 21-22, 33-34	11-12, 21-22, 33-34, 41-42, 53-54
[HS5E-KVH□]	Monitor Circuit: 11-12, 41-42, 51-52, 61-62	11-12, 41-42, 51-52, 61-62, 11-12, 21-22, 31-32, 41-42, 51-52, 61-62
[HS5E-KVJ□]	Monitor Circuit: 11-12, 41-42, 51-52, 63-64	11-12, 41-42, 51-52, 63-64, 11-12, 21-22, 31-32, 41-42, 51-52, 63-64

CAUTION

*9 This locking monitoring marking has been newly described in section 9.2.1 of EN ISO / ISO 14119. It indicates that any devices with this marking meet the following EN ISO / ISO 14119 requirements:

- General (- General requirements for guard locking devices) (Section 5.7.1) *
- Locking monitoring (- Locking monitoring for guard locking devices) (Section 5.7.2.2)

When a lock monitor circuit (contact) has the locking monitoring marking, it means that one circuit (contact) can monitor the position and the locking function of the protective door. (The locking monitoring circuit (contact) is opened when opening or unlocking the protective door.)

*note HS5E-K safety switches have obtained the locking monitoring certification marking.

*10 Type Nos. in [] are not supplied as standard. Contact IDEC if required.

*11 The Actuator is inserted, and HS5E is locked.

- Contact operation is based on the condition that the actuator is inserted into the center of the interlock switch slot.
- Contact operation shows the HS9Z-A51 actuator. (For other actuators, add 1.3 mm to contact operation.)
- Terminals 12-41 are connected together internally. Use terminals 11-42 for safety circuit inputs.
- Use main circuit or monitor circuit with for the input to safety circuit.
- (Type HS5E-KDD) Terminals 12-41, 22-51 are connected together internally. Use terminals 11-42, 21-52 for safety circuit inputs.

Operation Cycle

Door States	Closed	Closed	Open	Closed
Main Circuit	11-42 21-52	Closed	Open	Open
Monitor Circuit	11-12 21-22 31-32	Closed	Closed	Open
Monitor Circuit	23-24 33-34	Open	Open	Closed
Monitor Circuit	41-42 51-52 61-62	Closed	Open	Open
Monitor Circuit	53-54 63-64	Open	Closed	Closed
Key Position /Rear Unlock Button	Lock Position /Returned status	Unlock Position /Returned status	Unlock Position /Returned status	Lock Position /When operating the Button
	Door is locked. The machine can be operated.	Door is unlocked. The machine can not be operated.	The machine can not be operated.	Door is unlocked. The machine can not be operated.

6 Wiring

Wiring

- Cable specifications UL style 2464 (80°C 300V)
 (Type HS5E-K□, KDD) 8c × No.21 AWG
 (Type HS5E-KV□) 12c × No.22 AWG
- Wire identification
 Wires are identified by the color and white line printed on the wire.
 (Type HS5E-KV□) Do not use wire which is Gray, Gray / White.
 (Type HS5E-KDD) Do not use wire which is Brown, Brown / White.

(Type HS5E-K□, HS5E-DD) (Type HS5E-KV□)

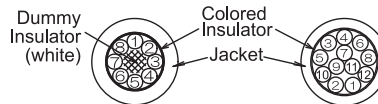

No.	Insulator Color	No.	Insulator Color
1	White	7	Blue / White
2	Black	8	Orange / White
3	Brown	9	Pink
4	Blue	10	Pink / White
5	Brown / White	11	Gray
6	Orange	12	Gray / White

Terminal Number Identification

- When wiring, the terminal number on each contact is identified by wire color.
- The following shows the identification of terminal number.
- When wiring, cut unnecessary wires such as dummy insulator (white) and/or unused wires to avoid incorrect wiring.
 (Type HS5E-KV□)
 Blue/White is circuit No. 12.
 (Type HS5E-KDD)
 Orange/White is circuit No. 52.

Circuit No.	Insulator Color
11	Blue
(12), 42	Blue / White
21, 23, 61, 63	Orange
22, 24, [52], 62, 64	Orange / White
31, 33, 51, 53	Brown
32, 34, 52, 54	Brown / White
41	Pink
42	Pink / White
A1 (-)	Black
A2 (+)	White

7 Example of wiring Diagram realizing Safety Category

Example of a circuit diagram for Safety Category 3 (attainable PL = d)

(Condition 1: To apply the fault exclusion of mechanical structural parts including the actuator → Make sure to use the product within the product specification range described in this manual and the version of the manual provided with the product.)

(Condition 2: Documentation of the reason for the machine/equipment manufacturer to have applied the fault exclusion based on EN ISO13849-1, EN ISO13849-2 or IEC62061.)

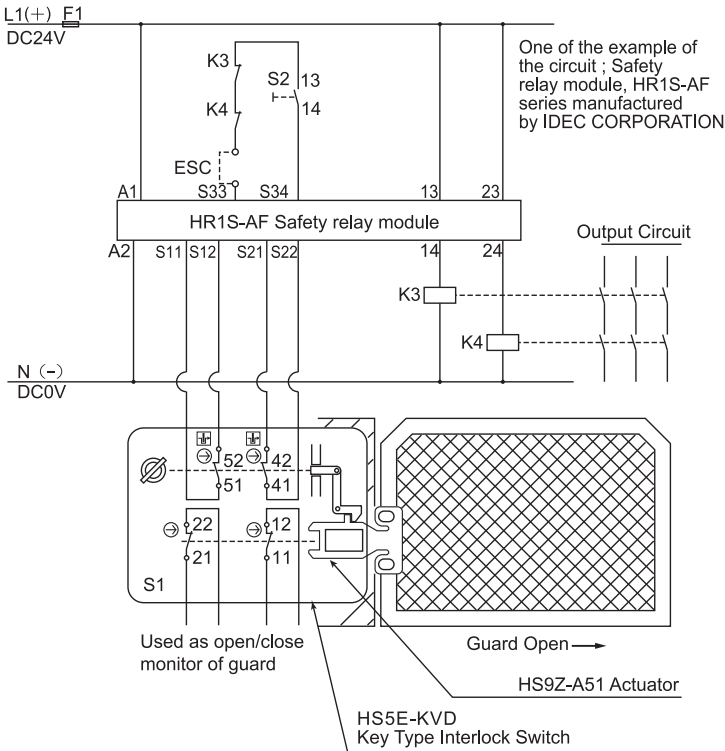

- S1: HS5E-KVD Key Type Interlock Switch
- S2: Starting Switch (HW Series Momentary)
- S3: Safety limit Switch
- ESC: Outside start condition
- K3, 4: Safety Contactor
- F1: Outside fuse of safety relay module at power supply line

Example of a circuit diagram for Safety Category 4 (attainable PL = e)

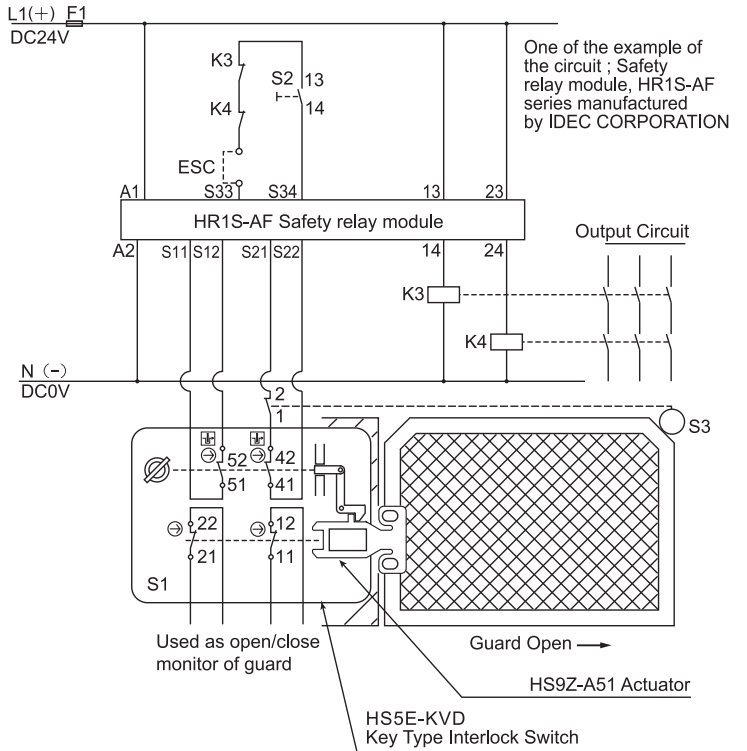

Note: Use the monitoring device(Safety relay module) provided the capability to detect a cross short circuit. The insulation of the cable has to withstand environmental influences. If a control device other than the one shown in the draft is used, the used control device has to be equipped with a cross short circuit monitor.

Type : HS9Z-A55S
Angle Adjustable (vertical/horizontal) Actuator with plate

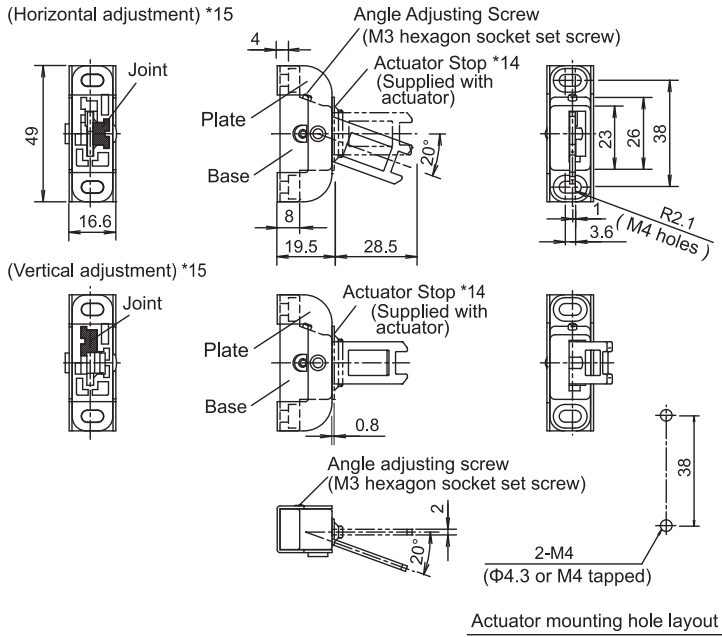

*14 The actuator stop and The Stopper film are used when adjusting the actuator position. Remove after the actuator position is determined.

*15 The direction of adjustable angle can be changed (vertical or horizontal) by changing the insertion direction of the joint.
Do not lose the joints. Actuators do not operate normally without a joint.

(Horizontal adjustment) (Vertical adjustment)

9 Precaution for Disposal

Dispose of the HS5E-K interlock switch as an industrial waste.

IDEC CORPORATION <http://www.idec.com>

Manufacturer: IDEC CORP.
2-6-64 Nishimiyahara Yodogawa-ku, Osaka 532-0004, Japan

EU Authorized Representative: APEM SAS
55, Avenue Edouard Herriot BP1, 82303 Caussade Cedex, France

EU DECLARATION OF CONFORMITY
We, IDEC CORPORATION 2-6-64, Nishimiyahara Yodogawa-ku, Osaka 532-0004, Japan declare under our sole responsibility that the product:

Description: Interlock Switch
Model No: HS5E-K

Applied Union harmonized legislation and references to the relevant harmonization standards used or references the other technical specifications in relation to which conformity is declared.

Applicable EU Directive : Low Voltage Directive (2014/35/EU)
Machinery Directive (2006/42/EC)
RoHS Directive (2011/65/EU)

Applicable Standard(s) : EN 60947-5-1, GS-ET-19, EN IEC 63000

UK Authorized Representative: APEM COMPONENTS LIMITED

Drakes Drive, Long Crendon, Buckinghamshire, HP18 9BA, UK
Applicable UK Directive : Electrical Equipment (Safety) Regulations 2016,
Supply of Machinery (Safety) Regulations 2008,
The Restriction of the Use of Certain Hazardous Substances in
Electrical and Electronic Equipment Regulations 2012
Applicable Standard(s) : EN 60947-5-1, EN IEC 63000, EN ISO 14119