

LH series Surface Mount Indicators

**Innovative indicators with IP67 protection and integrated cable wiring.
Directly mountable on equipment and aluminum frames (jumbo dome models).**

- Surface mount style does not affect the location of other components. Requires only a small space behind the mounting surface.
- Integrated cable wiring ensures waterproof characteristics. 1m, 3m, and 5m cables available. M12 connector cable (30 cm) available for jumbo dome model.
- IP67 (IEC60529) rated. Can be used in environments subject to washdown.
- Slim design well suited for installation in small spaces.
- Excellent visibility from the front and from the side.
- Legends and symbols can be printed on marking film to customize flat model.
- Two-color alternate illumination available for all models. (Except A/G, A/PW Jumbo dome types)
- Three-color alternate illumination available with jumbo dome model.



Specifications

Type	Cable	M12 Connector
Rated Insulation Voltage (Ui)	32V	
Rated Voltage	24V AC/DC	24V DC
Operating Voltage Range	24V AC/DC ±10%	24V DC ±10%
Rated Current	17 mA (Dome: 13 mA)	
Maximum Current Draw	0.6W	

- Use Class 2 power supply when using the LH1D as a UL compliant product.
- 24V AC, 50/60 Hz
- M12 connectors are available for jumbo dome models only.

Model		Jumbo Dome	Dome / Flat
Illumination Colors	Single Color	R (red), G (green), Y (yellow), A (amber), S (blue), PW (pure white),	
	Two-Color Alternate	R/G, R/PW, G/PW	R/G
	Three-Color Alternate	R/G/PW	

Specifications



Applicable Standards	IEC60947-5-1, IEC60947-1 EN60947-5-1, EN60947-1 UL508, CSA C22.2 No.14
Operating Temperature	-20 to +55°C (no freezing)
Operating Humidity	45 to 85% RH (no condensation)
Storage Temperature	-30 to +80°C (no freezing)
Impulse Withstand Voltage (illuminating part)	800V
Insulation Resistance	Between live and dead parts: 100 MΩ minimum
Dielectric Strength	Between live and dead parts: 2000V, 50/60 Hz, 1 minute
Pollution Degree	3
Vibration Resistance	5 to 55 Hz, amplitude 0.5 mm
Shock Resistance	1000 m/s ²
Degree of Protection	IP67 (IEC60529) NEMA Type 4X Indoor Use Only (Note)
Housing Color	Black
LED Lamp Life	Approx. 50,000 hours (When used on complete DC at 25°C, brightness reduces to 50% of the initial intensity.)
Weight	140g (jumbo dome model, 1m cable) 50g (dome model, 1m cable) 50g (flat model, 1m cable)

Note: Jumbo dome model is NEMA Type 1 under UL listing.

Model		Jumbo Dome	Dome/Flat
Cable	Single Color	UL20276, 21 AWG, 3-core Cable outside diameter: ø4.9 mm Allowable cable bending radius: 30 mm	UL20276, 24AWG, 3-core Cable outside diameter: ø4.1 mm Allowable cable bending radius: 24.6 mm
	Two-Color Alternate		
	Three-Color Alternate	UL20276, 22AWG, 4-core Cable outside diameter: ø5.0 mm Allowable cable bending radius: 30 mm	
Connector		20AWG, 4-core Cable length: 0.3m Cable outside diameter: ø6.0 mm Allowable cable bending radius: 40 mm M12 one-touch connector	

Jumbo Dome Model

Package Quantity: 1

Shape	Types	Ordering Part No.	Illumination Color
 Jumbo Dome (ø66) One color	Cable	1m	LH1D-D3HQ4C10①
		3m	LH1D-D3HQ4C30①
		5m	LH1D-D3HQ4C50①
	Connector	LH1D-D3HQ4CN1①	
 Jumbo Dome (ø66) 2-color alternate	Cable	1m	LH1D-D3HQ4C10①②
		3m	LH1D-D3HQ4C30①②
		5m	LH1D-D3HQ4C50①②
	Connector	LH1D-D3HQ4CN1①②	
 Jumbo Dome (ø66) 3-color alternate	Cable	1m	LH1D-D3HQ4C10①②③
		3m	LH1D-D3HQ4C30①②③
		5m	LH1D-D3HQ4C50①②③
	Connector	LH1D-D3HQ4CN1①②③	

Specify a color code in place of ① in the Part No.
Color code: R, G, Y, A, S, PW

Specify a color code in place of ①/② in the Part No.
Color code: R/G, R/PW, G/PW
(Two-color alternate)

Specify a color code in place of ①/②/③ in the Part No.
Color code: R/G/PW
(Three-color alternate)

- Color code: R (red), G (green), Y (yellow), A (amber), S (blue), PW (pure white)
- For orange, specify "A" (for amber).

Dimensions

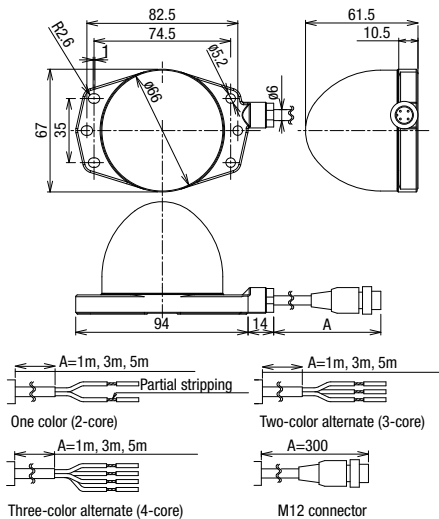

Mounting Hole Layout

All dimensions in mm.

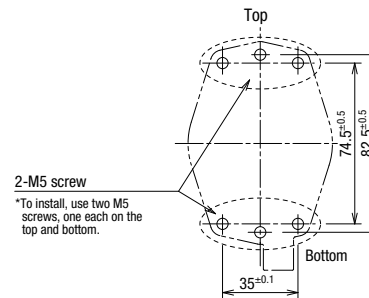

2-M5 screw
*To install, use two M5 screws, one each on the top and bottom.

Internal Circuit

• One-color Illumination

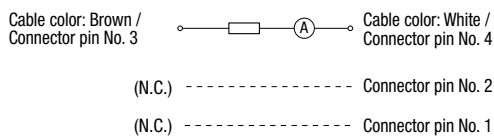

• Two-color Alternate Illumination

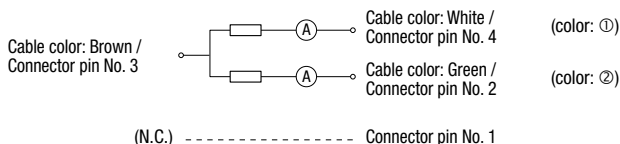

• Three-color Alternate Illumination

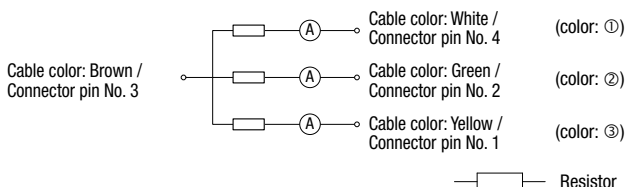

Lens Colors

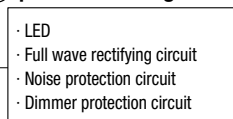

	Illumination Color	Lens Color
One Color	Red (R) Green (G) Yellow (Y) Amber (A) Blue (S) Pure White (PW)	Red Green Yellow Amber Blue White
Two-color Alternate	Red (R) / Green (G) Red (R) / Pure White (PW) Green (G) / Pure White (PW)	White White White
Three-color Alternate	Red (R) / Green (G) / Pure White (PW)	White

* (A) part of left diagrams.



Dome Model

Package Quantity: 1

Shape	Cable	Ordering Part No.	Illumination Color
Dome ø37 One Color 	1m	LH1D-D2HQ4C10ⓐ	Specify a color code in place of ⓐ in the Part No. R: red G: green Y: yellow A: amber S: blue PW: pure white
	3m	LH1D-D2HQ4C30ⓐ	
	5m	LH1D-D2HQ4C50ⓐ	
Dome ø37 Red/Green 2-color alternate 	1m	LH1D-D2HQ4C10RG	R (red) / G (green) 2-color alternate illumination
	3m	LH1D-D2HQ4C30RG	
	5m	LH1D-D2HQ4C50RG	

• For orange, specify "A" (for amber).

Dimensions

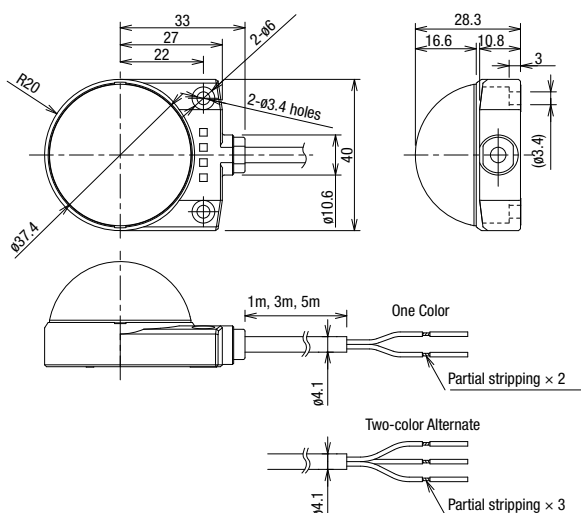

Mounting Hole Layout

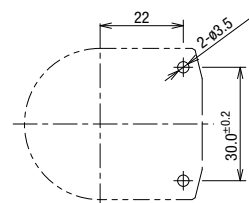

All dimensions in mm.

Internal Circuit

• One-color Illumination

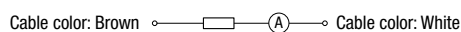

• Two-color Alternate Illumination

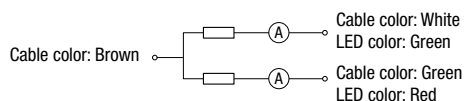

Lens Colors

Illumination Type	Illumination Color	Lens Color
One Color	Red (R)	Red
	Green (G)	Green
	Yellow (Y)	Yellow
	Amber (A)	Amber
	Blue (S)	Blue
	Pure White (PW)	Clear (Note)
Two-color Alternate	Red (R) / Green (G)	Clear (Note)



Note: Because lenses have a white diffusion cover inside, clear lens type appear white when the light is off.

* ⓐ part of left diagrams.

- LED
- Full wave rectifying circuit
- Noise protection circuit
- Dimmer protection circuit

Flat Model

Package Quantity: 1

Shape	Cable	Ordering Part No.	Illumination Color
Flat One Color 	1m	LH1D-H2HQ4C10⊙	Specify a color code in place of ⊙ in the Part No. R: red G: green Y: yellow A: amber S: blue PW: pure white
	3m	LH1D-H2HQ4C30⊙	
	5m	LH1D-H2HQ4C50⊙	
Flat Red/Green 2-color Alternate 	1m	LH1D-H2HQ4C10RG	R (red) / G (green) 2-color alternate illumination
	3m	LH1D-H2HQ4C30RG	
	5m	LH1D-H2HQ4C50RG	

• For orange, specify "A" (for amber).

Dimensions

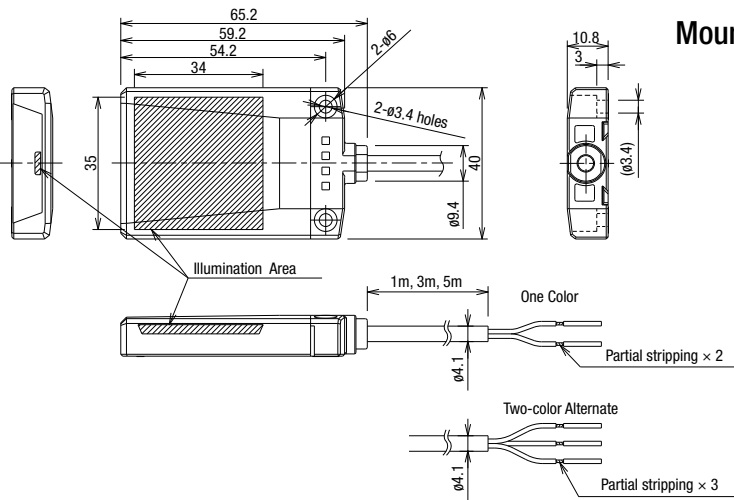

Mounting Hole Layout

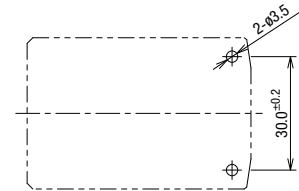

All dimensions in mm.

Internal Circuit

• One-color Illumination

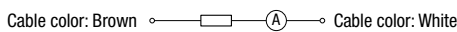

• Two-color Alternate Illumination

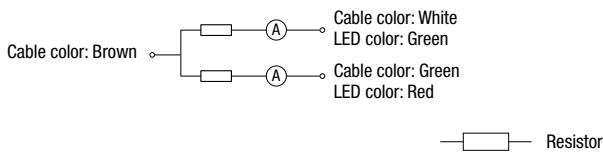

Lens Colors

Illumination Type	Illumination Color	Lens Color
One Color	Red (R)	Red
	Green (G)	Green
	Yellow (Y)	Yellow
	Amber (A)	Amber
	Blue (S)	Blue
	Pure White (PW)	Clear
Two-color Alternate	Red (R) / Green (G)	Clear

* (A) part of left diagrams.

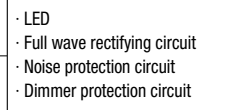

Replacement Parts

Package Quantity: 1

Shape	Material	Ordering Part No.	Lens Color
Lens (flat model) 	Polyarylate	LH9Z-1DLH2⊙	For flat model. Specify a color code in place of ⊙ in the Part No. R: red, G: green, Y: yellow, A: amber, C: clear, S: blue

Note: Use C (clear) lens for R / G (red/green alternate) or PW (pure white) illumination.

Safety Precautions

- Do not disassemble, repair, or modify the LH1D indicator, otherwise electric shock, damage, fire, or malfunction may occur.
- Do not pull out or push in the cable of the LH1D indicator, otherwise damage may occur. Provide a slack in the cable while wiring.
- The LH1D indicator is a general-purpose and industrial electronic device. Do not use the LH1D indicator for electronic equipment which may damage the human body or threaten life in case of malfunction or failure.

Operating Instructions

- LED elements may vary in colors and brightness.
- The LH1D indicator is vulnerable to static electricity. Take sufficient protection against static electricity and spikes.
- For one-color illumination of cable types, the green wire is cut short because it is not used. When cutting the cable for shorter wiring, cut the green wire short or make sure that the green wire is not used.

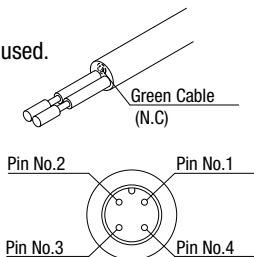

- The pin layout of connector type is shown at the right.

- Excessive shock to the LH1D may cause damage or failure, and the internal lens may fall off even if no defects are found externally. The internal lens may have fallen off when:
 - The illumination varies greatly when viewed from the side.
 - The indicator makes a rattling sound when shaken lightly.
 When any of the above is observed, contact IDEC.

Note: Do not remove the lens.

 The specified degree of protection cannot be assured when the lens is removed.

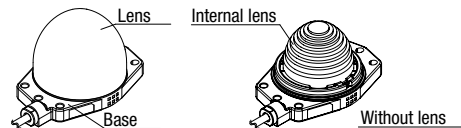

Panel Mounting

Using two M3 screws (M5 screws for jumbo dome models), install the LH1D indicator to a mounting surface. Tighten the screws to a torque of 0.6 N·m maximum (1.0 to 1.4 N·m for jumbo dome models). Mounting screws are not provided and must be supplied by the user.

Jumbo Dome Model

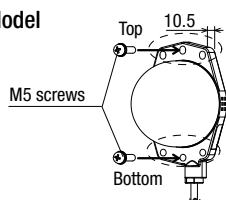

- Note 1: Take into account the thickness of the base (10.5 mm), when selecting the length of the screws.
- Note 2: Take appropriate anti-loosening measures such as spring washers and screw locks.
- Note 3: Install the LH1D using two M5 screws, one each on the top and the bottom.

Dome Model

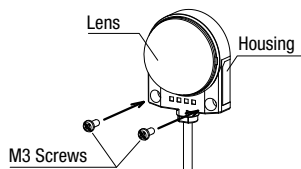

Note: The dome lens is not removable. Do not attempt to remove the lens, otherwise damage will occur.

Flat Model

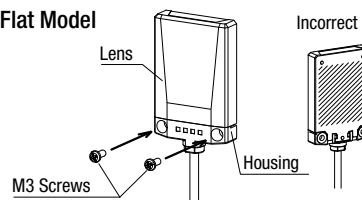

- Note 1: Do not install the LH1D indicator by attaching only the lens, such as by taping down the lens. Otherwise internal components may come loose.
- Note 2: Make sure that the back of the indicator is securely attached to the mounting surface, so that the lens cannot be easily removed.

Inserting Marking Film into Flat Model Lens

1. Insert a flat screwdriver into the groove between the base and lens. Do not use flat screwdrivers with a tip width of 1.0 mm or more.

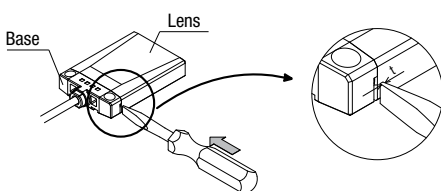

2. Twist the screwdriver and disengage the lens from the base.

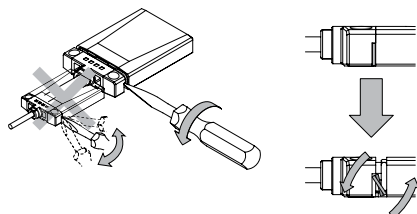

3. Remove the lens from the base.

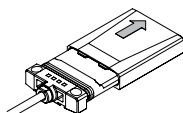

4. Insert the edge of a marking film into the gap between the base and the diffusion plate, and place the marking film on top of the diffusion plate.

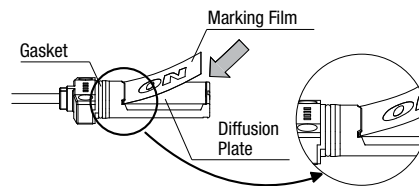

5. Install the lens. Ensure that the lens is installed snugly.

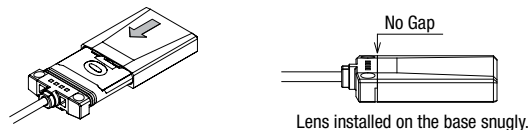

- Note 1: Do not touch the gasket, as this may affect its waterproof characteristics.
- Note 2: Do not touch the diffusion plate.

Markings

Legends and symbols can be printed on marking film for the flat lens. One 0.1 mm-thick film can be installed. Marking film is not attached and must be supplied by the user. Recommended marking film: Polyester

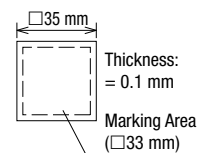

Ordering Terms and Conditions

Thank you for using IDEC Products.

By purchasing products listed in our catalogs, datasheets, and the like (hereinafter referred to as "Catalogs") you agree to be bound by these terms and conditions. Please read and agree to the terms and conditions before placing your order.

1. Notes on contents of Catalogs

- (1) Rated values, performance values, and specification values of IDEC products listed in this Catalog are values acquired under respective conditions in independent testing, and do not guarantee values gained in combined conditions.
Also, durability varies depending on the usage environment and usage conditions.
- (2) Reference data and reference values listed in Catalogs are for reference purposes only, and do not guarantee that the product will always operate appropriately in that range.
- (3) The specifications / appearance and accessories of IDEC products listed in Catalogs are subject to change or termination of sales without notice, for improvement or other reasons.
- (4) The content of Catalogs is subject to change without notice.

2. Note on applications

- (1) If using IDEC products in combination with other products, confirm the applicable laws / regulations and standards.
Also, confirm that IDEC products are compatible with your systems, machines, devices, and the like by using under the actual conditions. IDEC shall bear no liability whatsoever regarding the compatibility with IDEC products.
- (2) The usage examples and application examples listed in Catalogs are for reference purposes only. Therefore, when introducing a product, confirm the performance and safety of the instruments, devices, and the like before use. Furthermore, regarding these examples, IDEC does not grant license to use IDEC products to you, and IDEC offers no warranties regarding the ownership of intellectual property rights or non-infringement upon the intellectual property rights of third parties.
- (3) When using IDEC products, be cautious when implementing the following.
 - i. Use of IDEC products with sufficient allowance for rating and performance
 - ii. Safety design, including redundant design and malfunction prevention design that prevents other danger and damage even in the event that an IDEC product fails
 - iii. Wiring and installation that ensures the IDEC product used in your system, machine, device, or the like can perform and function according to its specifications
- (4) Continuing to use an IDEC product even after the performance has deteriorated can result in abnormal heat, smoke, fires, and the like due to insulation deterioration or the like. Perform periodic maintenance for IDEC products and the systems, machines, devices, and the like in which they are used.
- (5) IDEC products are developed and manufactured as general-purpose products for general industrial products. They are not intended for use in the following applications, and in the event that you use an IDEC product for these applications, unless otherwise agreed upon between you and IDEC, IDEC shall provide no guarantees whatsoever regarding IDEC products.
 - i. Use in applications that require a high degree of safety, including nuclear power control equipment, transportation equipment (railroads / airplanes / ships / vehicles / vehicle instruments, etc.), equipment for use in outer space, elevating equipment, medical instruments, safety devices, or any other equipment, instruments, or the like that could endanger life or human health
 - ii. Use in applications that require a high degree of reliability, such as provision systems for gas / waterworks / electricity, etc., systems that operate continuously for 24 hours, and settlement systems
 - iii. Use in applications where the product may be handled or used deviating from the specifications or conditions / environment listed in the Catalogs, such as equipment used outdoors or applications in environments subject to chemical pollution or electromagnetic interference
If you would like to use IDEC products in the above applications, be sure to consult with an IDEC sales representative.

3. Inspections

We ask that you implement inspections for IDEC products you purchase without delay, as well as thoroughly keep in mind management/maintenance regarding handling of the product before and during the inspection.

4. Warranty

- (1) Warranty period
The warranty period for IDEC products shall be one (1) year after purchase or delivery to the specified location. However, this shall not apply in cases where there is a different specification in the Catalogs or there is another agreement in place between you and IDEC.
- (2) Warranty scope
Should a failure occur in an IDEC product during the above warranty period for reasons attributable to IDEC, then IDEC shall replace or repair that product, free of charge, at the purchase location / delivery location of the product, or an IDEC service base. However, failures caused by the following reasons shall be deemed outside the scope of this warranty.
 - i. The product was handled or used deviating from the conditions / environment listed in the Catalogs
 - ii. The failure was caused by reasons other than an IDEC product
 - iii. Modification or repair was performed by a party other than IDEC
 - iv. The failure was caused by a software program of a party other than IDEC
 - v. The product was used outside of its original purpose
 - vi. Replacement of maintenance parts, installation of accessories, or the like was not performed properly in accordance with the user's manual and Catalogs
 - vii. The failure could not have been predicted with the scientific and technical standards at the time when the product was shipped from IDEC
 - viii. The failure was due to other causes not attributable to IDEC (including cases of force majeure such as natural disasters and other disasters)Furthermore, the warranty described here refers to a warranty on the IDEC product as a unit, and damages induced by the failure of an IDEC product are excluded from this warranty.

5. Limitation of liability

The warranty listed in this Agreement is the full and complete warranty for IDEC products, and IDEC shall bear no liability whatsoever regarding special damages, indirect damages, incidental damages, or passive damages that occurred due to an IDEC product.

6. Service scope

The prices of IDEC products do not include the cost of services, such as dispatching technicians. Therefore, separate fees are required in the following cases.

- (1) Instructions for installation / adjustment and accompaniment at test operation (including creating application software and testing operation, etc.)
- (2) Maintenance inspections, adjustments, and repairs
- (3) Technical instructions and technical training
- (4) Product tests or inspections specified by you

The above content assumes transactions and usage within your region. Please consult with an IDEC sales representative regarding transactions and usage outside of your region. Also, IDEC provides no guarantees whatsoever regarding IDEC products sold outside your region.

IDEC CORPORATION

Head Office 6-64, Nishi-Miyahara-2-Chome, Yodogawa-ku, Osaka 532-0004, Japan

USA IDEC Corporation
EMEA APEM SAS

Singapore IDEC Izumi Asia Pte. Ltd.
Thailand IDEC Asia (Thailand) Co., Ltd.
India IDEC Controls India Private Ltd.

China IDEC (Shanghai) Corporation
IDEC Izumi (H.K.) Co., Ltd.
Taiwan IDEC Taiwan Corporation

 www.idec.com

Japan IDEC Corporation

Specifications and other descriptions in this brochure are subject to change without notice.

2023 IDEC Corporation, All Rights Reserved.

