

FC9Y-B1283(1)

FC5A SERIES
MICROSmart _____
_____ *pentra* _____

PID Module

User's Manual

IDEC CORPORATION

SAFETY PRECAUTIONS

- Read this user's manual to make sure of correct operation before starting installation, wiring, operation, maintenance, and inspection of the FC5A series MicroSmart PID modules.
- All MicroSmart modules are manufactured under IDEC's rigorous quality control system, but users must add a backup or failsafe provision to the control system using the MicroSmart in applications where heavy damage or personal injury may be caused in case the MicroSmart should fail.
- In this user's manual, safety precautions are categorized in order of importance from Warning to Caution.



Warning

Warning notices are used to emphasize that improper operation may cause severe personal injury or death.

- Turn off the power to the MicroSmart before starting installation, removal, wiring, maintenance, and inspection of the MicroSmart. Failure to turn power off may cause electrical shocks or fire hazard.
- Special expertise is required to install, wire, program, and operate the MicroSmart. People without such expertise must not use the MicroSmart.
- Emergency stop and interlocking circuits must be configured outside the MicroSmart. If such a circuit is configured inside the MicroSmart, failure of the MicroSmart may cause a malfunction of the control system, damage, or accidents.
- Install the MicroSmart according to the instructions described in this user's manual. Improper installation will result in disattachment, failure, or malfunction of the MicroSmart.



Caution

Caution notices are used where inattention might cause personal injury or damage to equipment.

- The MicroSmart is designed for installation in a cabinet. Do not install the MicroSmart outside a cabinet.
- Install the MicroSmart in environments described in this user's manual. If the MicroSmart is used in places where the MicroSmart is subjected to high-temperature, high-humidity, condensation, corrosive gases, excessive vibrations, and excessive shocks, then electrical shocks, fire hazard, or malfunction will result.
- The environment for using the MicroSmart is "Pollution degree 2." Use the MicroSmart in environments of pollution degree 2 (according to IEC 60664-1).
- Prevent the MicroSmart from being dropped while moving or transporting the MicroSmart, otherwise damage or malfunction of the MicroSmart will result.
- Prevent metal fragments and pieces of wire from dropping inside the MicroSmart housing. Put a cover on the MicroSmart modules during installation and wiring. Ingress of such fragments and chips may cause fire hazard, damage, or malfunction.
- Use a power supply matching the rated value. Use of an incorrect power supply may cause fire hazard.
- Use an IEC 60127-approved fuse on the power line outside the MicroSmart. This is required when equipment containing the MicroSmart is destined for Europe.
- Use an IEC 60127-approved fuse on the output circuit. This is required when equipment containing the MicroSmart is destined for Europe.

- Use an EU-approved circuit breaker. This is required when equipment containing the MicroSmart is destined for Europe.
- Make sure of safety before starting and stopping the MicroSmart or when operating the MicroSmart to force outputs on or off. Incorrect operation on the MicroSmart may cause machine damage or accidents.
- If relays or transistors in the MicroSmart output modules should fail, outputs may remain on or off. For output signals which may cause serious accidents, provide a monitor circuit outside the MicroSmart.
- Do not connect the ground wire directly to the MicroSmart. Connect a protective ground to the cabinet containing the MicroSmart using an M4 or larger screw. This is required when equipment containing the MicroSmart is destined for Europe.
- Do not disassemble, repair, or modify the MicroSmart modules.
- When disposing of the MicroSmart, do so as an industrial waste.

ABOUT THIS MANUAL

Thank you for purchasing FC5A series MicroSmart PID Module. This user's manual primarily describes system configuration, specifications, installation, programming, application examples, and trouble shooting of the PID module. Read this user's manual to ensure the correct understanding of the entire functions of the PID module.

NOTICE

1. This publication is not to be, nor any parts of it, photocopied, reprinted, sold, transferred, or rented out without the specific written permission and consent of IDEC.
2. The contents of this user's manual are subject to change without notice.
3. Care has been taken to ensure that the contents of this user's manual are correct, but if there are any doubts, mistakes or questions, please inquire our sales department.

MicroSmart Modules

Category		Modules
MicroSmart (FC5A Series MicroSmart)		FC5A series MicroSmart pentra
FC5 Series CPU Modules	All-in-One Type	FC5A-C10R2, FC5A-C10R2C, FC5A-C16R2, FC5A-C16R2C, FC5A-C24R2, FC5A-C24R2C
	Slim Type	FC5A-D16RK1, FC5A-D16RS1, FC5A-D32K3, FC5A-D32S3, FC5A-D12K1E, FC5A-D12S1E
PID Modules		FC5A-F2MR2, FC5A-F2M2
Expansion Communication Modules		FC5A-SIF2, FC5A-SIF4
Memory Cartridge		FC4A-PM32, FC4A-PM64, FC4A-PM128
Expansion Modules		Expansion I/O module, Function module
Expansion I/O Modules		Input modules, Output modules, Mixed I/O modules
Function Modules		Analog modules, AS-Interface master module, PID module
Communication Expansion Modules		HMI base module, expansion RS232C communication module, expansion RS485 communication module
Optional Modules		HMI module, Memory cartridge, Clock cartridge, RS232C communication adapter, RS485 communication adapter
WindLDR		Application software [WindLDR]



Caution

The PID modules is used by connecting to the FC5A series CPU module. Use this product after thoroughly understanding the specifications of the FC5A series CPU module.

IMPORTANT INFORMATION

Under no circumstances shall IDEC Corporation be held liable or responsible for indirect or consequential damages resulting from the use of or the application of IDEC PLC components, individually or in combination with other equipment.

All persons using these components must be willing to accept responsibility for choosing the correct component to suit their application and for choosing an application appropriate for the component, individually or in combination with other equipment.

All diagrams and examples in this user's manual are for illustrative purposes only. In no way does including these diagrams and examples in this manual constitute a guarantee as to their suitability for any specific application. To test and approve all programs, prior to installation, is the responsibility of the end user.

REVISION HISTORY

Revision history of this user's manual is described here.

Date	Manual No.	Description
March, 2011	FC9Y-B1283-0	First print
January, 2015	FC9Y-B1283-1	Added "Confirming the PID Module System Program Version"
		Added "External PV Mode" to "PID Module Main Functions"
		Added the "External PV Mode" specification to "Data Register Allocation - Block 0 Read Only Parameters"
		Added the "External PV Mode" specification to "Data Register Allocation - Block 1 Write Only Parameters"
		Added the "External PV Mode" specification to "PID Module Configuration - Input Parameters List (CH0 and CH1)"
		Added "When Input CH0 External PV Mode and Input CH1 External PV Mode are Enabled"
		Added the "External PV Mode" specification to "Monitoring Screen"
		Added "External PV Mode" to "PID Module Function References"
		Corrected "Factory Default Settings of the PID Module"

RELATED MANUALS

The following manuals related to the FC5A series MicroSmart are available. Refer to them in conjunction with this manual.

Type No.	Manual Name	Description
FC9Y-B1283	FC5A Series PID Module User's Manual (this manual)	Describes PID Module specifications and functions.
FC9Y-B1268	FC5A Series MicroSmart Pentra User's Manual Basic Volume	Describes module specifications, installation instructions, wiring instructions, basic operation, special function, device addresses, instruction list, basic instructions, analog modules, user communication, data link communication, Modbus ASCII/RTU communication, and troubleshooting.
FC9Y-B1273	FC5A Series MicroSmart Pentra User's Manual Advanced Volume	Describes instruction list, move instructions, data comparison instructions, binary arithmetic instructions, boolean computation instructions, shift/rotate instructions, data conversion instructions, week programmer instructions, interface instructions, program branching instructions, refresh instructions, interrupt control instructions, coordinate conversion instructions, average instructions, pulse output instructions, PID instructions, dual/teaching timer instructions, intelligent module access instructions, trigonometric function instructions, logarithm/power instructions, file data processing instructions, clock instructions, computer link communication, modem communication, Modbus TCP communication, expansion RS232C/RS485 communication modules, and AS-Interface master modules.
FC9Y-B1278	FC5A Series MicroSmart Pentra User's Manual Web Server CPU Module Volume	Describes FC5A Slim Type Web Server CPU Module specifications and functions.

TABLE OF CONTENTS

CHAPTER 1: GENERAL INFORMATION	1-1
About the PID Modules.....	1-1
Quantity of Applicable PID modules	1-1
Applicable CPU and WindLDR version	1-2
Confirming System Program Version	1-2
Confirming the PID Module System Program Version	1-3
CHAPTER 2: MODULE SPECIFICATIONS	2-1
PID Module.....	2-1
Specifications.....	2-3
Dimensions	2-6
CHAPTER 3: INSTALLATION AND WIRING	3-1
Mounting Hole Layout for Direct Mounting on Panel Surface	3-1
Terminal Connection	3-3
Terminal Arrangement	3-4
Type of Protection.....	3-5
Power Supply for PID Modules	3-6
CHAPTER 4: PID MODULE MAIN FUNCTIONS	4-1
Temperature Control Using the PID Module.....	4-1
Fixed Value Control	4-3
Auto-Tuning (AT)/Auto-Reset	4-6
Program Control	4-9
Heating/Cooling Control	4-14
Difference Input Control.....	4-14
Cascade Control.....	4-15
External PV Mode.....	4-18
CHAPTER 5: DEVICE ALLOCATION OF PID MODULE	5-1
Device Allocation of PID Module	5-1
Program Size	5-2
Valid Devices	5-2
Control Register.....	5-2
Control Relay	5-3
Data Register Allocation - Block 0 Read Only Parameters	5-7
Data Register Allocation - Block 1 Write Only Parameters.....	5-10
Data Register Allocation - Blocks 2, 3 Basic Parameters (SHOT Action)	5-18
Data Register Allocation - Blocks 4, 5 Initial Setting Parameters (SHOT Action)	5-20
Data Register Allocation - Blocks 10-19 CH0 Program Parameters (SHOT Action)	5-23
Data Register Allocation - Blocks 30-39 CH1 Program Parameters (SHOT Action).....	5-25
CHAPTER 6: CONFIGURING PID MODULE USING WINDLDR.....	6-1
Procedure to configure the PID module	6-1

Expansion Modules Configuration Dialog Box	6-6
PID Module Configuration Dialog Box	6-7
PID Module Configuration - Input Parameters List (CH0 and CH1).....	6-8
PID Module Configuration - Control Parameters List (CH0 and CH1)	6-14
PID Module Configuration - Output Parameters List (CH0 and CH1)	6-19
PID Module Configuration - Program Parameters List (CH0 and CH1)	6-21
PID Module Configuration - I/O Function Selections.....	6-23
PID Module Configuration - Input Parameters Details	6-26
PID Module Configuration - Control Parameters Details.....	6-36
PID Module Configuration - Output Parameters Details	6-47
PID Module Configuration - Program Parameters Details	6-49
Monitoring PID Module	6-54
CHAPTER 7: APPLICATION EXAMPLES	7-1
Application Example 1	7-1
Application Example 2	7-8
Application Example 3	7-15
CHAPTER 8: TROUBLESHOOTING	8-1
The PID Module Power LED (PWR) is OFF or Flashing.....	8-1
The PID Module output does not operate normally.	8-2
Hunting phenomenon is occurring while in ON/OFF control action	8-3
Hunting phenomenon is occurring while in PID, PI, PD, or P control action	8-3
The PID Module input does not operate normally.	8-4
Loop break alarm turns on even though the actuator operates normally.	8-6
Program control is terminated earlier than the configured time.	8-6
CHAPTER 9: APPENDIX	9-1
PID Module Function References	9-1
Output Action	9-5
Factory Default Settings of the PID Module	9-9

1: GENERAL INFORMATION

This chapter describes general information and specifications of the FC5A series PID modules. Make effective use of the PID modules after reading and understanding thoroughly functions and characteristics.

About the PID Modules

The PID module performs control actions to eliminate the deviation between the set point (SP) and process variable (PV). The PID module, which is an expansion module, is required to connect to the FC5A series CPU for use. Depending on the difference of output specifications, the PID modules are categorized into two types, and can be used by connecting to a FC5A slim type CPU, or 24-I/O all-in-one type CPU (except 12V DC CPU). The input channel can accept voltage, current, thermocouple or resistance thermometer signals. The output channel generates relay output, non-contact voltage (for SSR drive), or current signals.

To configure the PID modules, the Expansion Modules Configuration dialog box in WindLDR is used. The following table shows the PID module type numbers.

PID Module Type Numbers

Module Type	I/O Points	I/O Signal	Type No.
Relay Output	2 inputs	Thermocouple [K, J, R, S, B, E, T, N, PL- II, C (W/Re5-26)] Resistance thermometer (Pt100, JPt100) Voltage (0 to 1V DC, 0 to 5V DC, 1 to 5V DC, 0 to 10V DC) Current (0 to 20mA DC, 4 to 20mA DC)	FC5A-F2MR2
	2 outputs	Relay contact	
Non-Contact Voltage (for SSR drive)/ Current Output	2 inputs	Thermocouple [K, J, R, S, B, E, T, N, PL- II, C (W/Re5-26)] Resistance thermometer (Pt100, JPt100) Voltage (0 to 1V DC, 0 to 5V DC, 1 to 5V DC, 0 to 10V DC) Current (0 to 20mA DC, 4 to 20mA DC)	FC5A-F2M2
	2 outputs	Non-contact voltage(for SSR drive)/Current	

Quantity of Applicable PID modules

The maximum number of PID modules that can be connected to the MicroSmart CPU differs depending on the CPU type. The following table shows the maximum number of the PID modules.

Type	All-in-One Type			Slim Type
FC5A MicroSmart CPU	FC5A-C10R2 FC5A-C10R2C FC5A-C10R2D	FC5A-C16R2 FC5A-C16R2C FC5A-C16R2D FC5A-C24R2D	FC5A-C24R2 FC5A-C24R2C	FC5A-D16RK1 FC5A-D16RS1 FC5A-D32K3 FC5A-D32S3 FC5A-D12K1E FC5A-D12S1E
Number of PID Modules	—			4
				7

Applicable CPU and WindLDR version

PID modules can be used with the following FC5A CPU module system program version and WindLDR version as listed below.

Type	All-in-One Type			Slim Type
FC5A MicroSmart CPU	FC5A-C10R2 FC5A-C10R2C FC5A-C10R2D	FC5A-C16R2 FC5A-C16R2C FC5A-C16R2D FC5A-C24R2D	FC5A-C24R2 FC5A-C24R2C	FC5A-D16RK1 FC5A-D16RS1 FC5A-D32K3 FC5A-D32S3 FC5A-D12K1E FC5A-D12S1E
CPU System Program Version	—			230 or higher *1
WindLDR Version				6.40 or higher

*1: The PID module can be used with FC5A-D12K1E/-S1E with the system program version 100 or higher.

Confirming System Program Version

The system program version can be confirmed using WindLDR.

1. Connect a PC to port 1 or 2 of the FC5A CPU using serial computer link cable I/F (FC2A-KC4C) or USB cable HG9Z-XCM2A for FC5A-D12x1E CPU.
2. From the WindLDR menu bar, select **Online > Monitor**.
3. From the WindLDR menu bar, select **PLC > Status**. The PLC Status dialog box appears and system program version is shown.

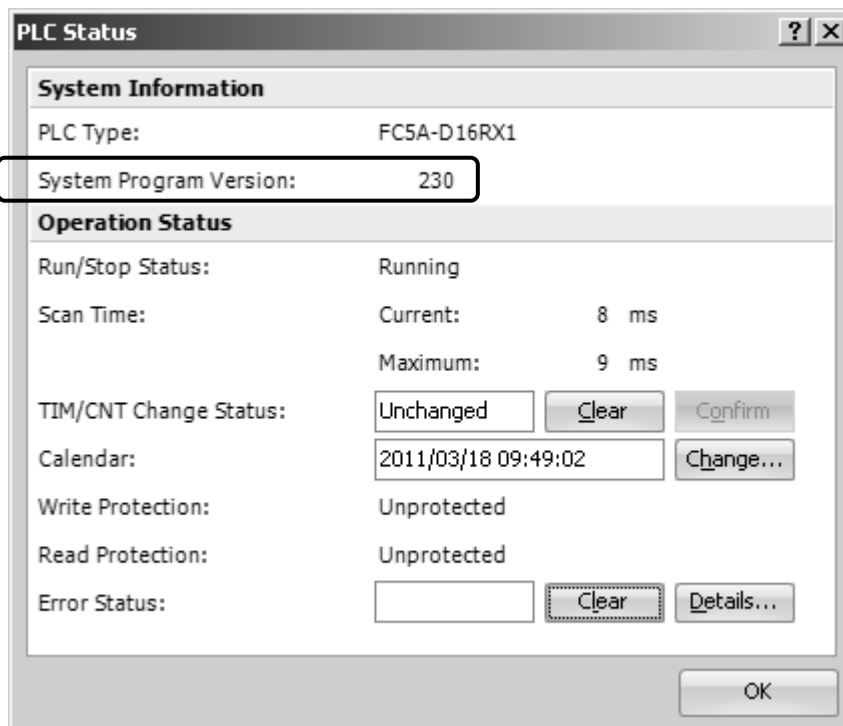

Confirming the PID Module System Program Version

The PID module system program version number can be checked with the module label on the PID module and is indicated on the module label as shown in the following diagram.

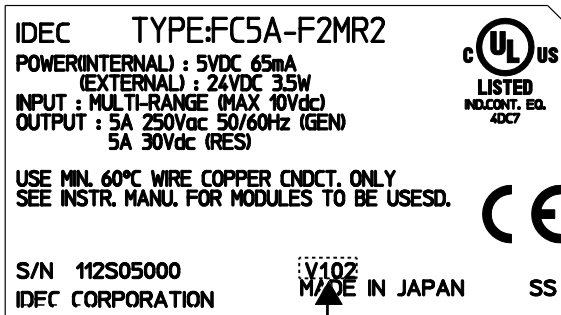

Version number

2: MODULE SPECIFICATIONS

This chapter describes parts names, functions, specifications, and dimensions of the PID modules.

PID Module

Parts Description

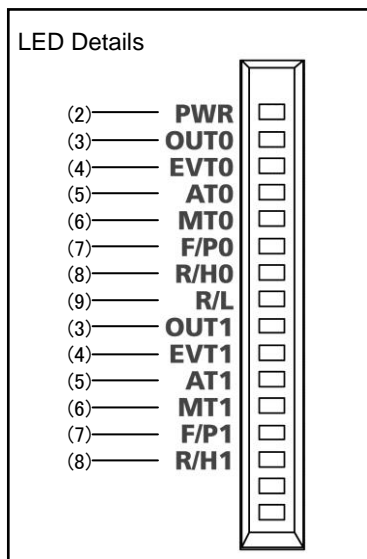
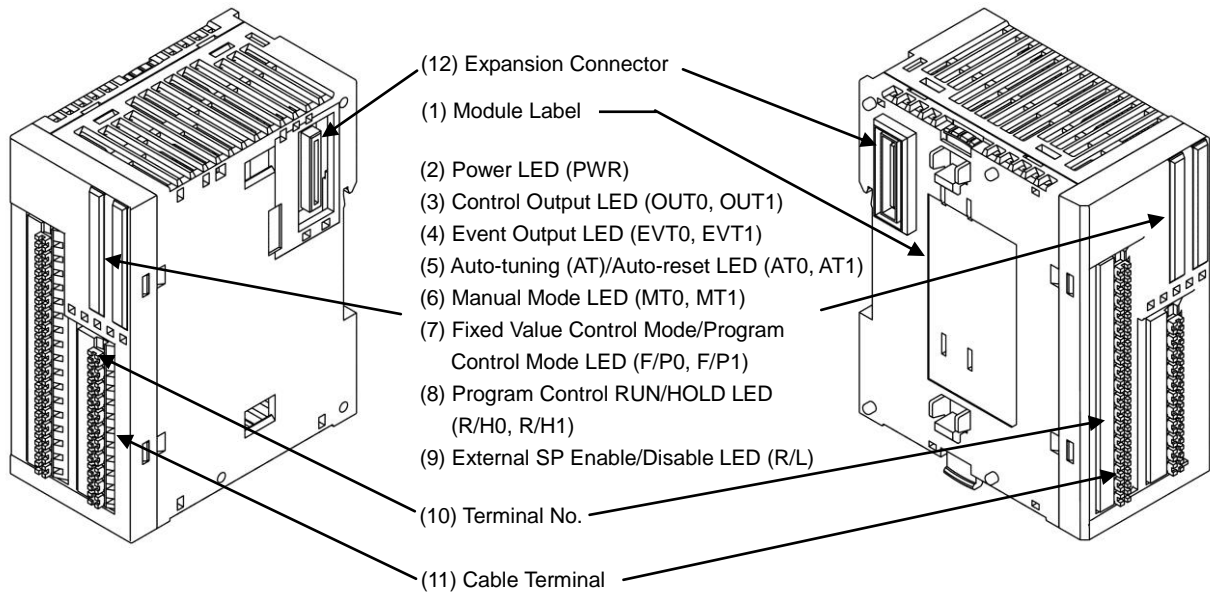

(1) Module Label

Indicates the PID module type No. and specifications.

(2) Power LED (PWR)

ON : Power is normally supplied.
 Flashes: External power supply (24V DC) error.
 OFF : Power is not supplied.

(3) Control Output LED (OUT0, OUT1)

- ON : Control output is turned on.
- OFF : Control output is turned off.
- Flashes: When current output is used, the LED flashes in a cycle of 125 ms according to the duty ratio of the output manipulated variable (MV). When output manipulated variable (MV) is 20%, the LED turns on for 25 ms and off for 100 ms continuously.

(4) Event Output LED (EVT0, EVT1)

- ON : Any alarm out of alarm 1 to alarm 8, loop break alarm is triggered.
- OFF : None of the alarms is triggered.

(5) Auto-tuning (AT)/Auto-reset LED (AT0, AT1)

- Flashes: Auto-tuning (AT) or auto-reset is performing.
- OFF : Auto-tuning (AT) or auto-reset is stopped.

(6) Manual Mode LED (MT0, MT1)

- ON : Manual mode
- OFF : Auto mode

(7) Fixed Value Control Mode/Program Control Mode LED (F/P0, F/P1)

- ON : Program control mode
- OFF : Fixed value control mode

(8) Program Control RUN/HOLD LED (R/H0, R/H1)

- ON : Program control is performing, or while in fixed value control enabled.
- Flashes: Program control is held, or power is restored.
- OFF : Program control is stopped, or while in fixed value control disabled.

(9) External SP Enable/Disable LED (R/L)

- ON : External SP input is enabled.
- OFF : External SP input is disabled.

(10) Terminal No. Indicates terminal numbers.

(11) Cable Terminal Spring clamp type terminal for connecting a cable.

(12) Expansion Connector Connects to the CPU module and other expansion modules.

Specifications

PID Module Specifications

Rating

Type No.	FC5A-F2MR2	FC5A-F2M2																																															
Rated Scale	Thermocouple																																																
	<table border="1"> <thead> <tr> <th>Type</th> <th>Measurement Range</th> <th>Input Value of LSB</th> </tr> </thead> <tbody> <tr> <td>K</td> <td>-200 to 1370°C</td> <td>-328 to 2498°F</td> <td>1°C (°F)</td> </tr> <tr> <td>K (with decimal point)</td> <td>-200.0 to 400.0°C</td> <td>-328.0 to 752.0°F</td> <td>0.1°C (°F)</td> </tr> <tr> <td>J</td> <td>-200 to 1000°C</td> <td>-328 to 1832°F</td> <td>1°C (°F)</td> </tr> <tr> <td>R</td> <td>0 to 1760°C</td> <td>32 to 3200°F</td> <td>1°C (°F)</td> </tr> <tr> <td>S</td> <td>0 to 1760°C</td> <td>32 to 3200°F</td> <td>1°C (°F)</td> </tr> <tr> <td>B</td> <td>0 to 1820°C</td> <td>32 to 3308°F</td> <td>1°C (°F)</td> </tr> <tr> <td>E</td> <td>-200 to 800°C</td> <td>-328 to 1472°F</td> <td>1°C (°F)</td> </tr> <tr> <td>T</td> <td>-200.0 to 400.0°C</td> <td>-328.0 to 752.0°F</td> <td>0.1°C (°F)</td> </tr> <tr> <td>N</td> <td>-200 to 1300°C</td> <td>-328 to 2372°F</td> <td>1°C (°F)</td> </tr> <tr> <td>PL-II</td> <td>0 to 1390°C</td> <td>32 to 2534°F</td> <td>1°C (°F)</td> </tr> <tr> <td>C(W/Re5-26)</td> <td>0 to 2315°C</td> <td>32 to 4199°F</td> <td>1°C (°F)</td> </tr> </tbody> </table>	Type	Measurement Range	Input Value of LSB	K	-200 to 1370°C	-328 to 2498°F	1°C (°F)	K (with decimal point)	-200.0 to 400.0°C	-328.0 to 752.0°F	0.1°C (°F)	J	-200 to 1000°C	-328 to 1832°F	1°C (°F)	R	0 to 1760°C	32 to 3200°F	1°C (°F)	S	0 to 1760°C	32 to 3200°F	1°C (°F)	B	0 to 1820°C	32 to 3308°F	1°C (°F)	E	-200 to 800°C	-328 to 1472°F	1°C (°F)	T	-200.0 to 400.0°C	-328.0 to 752.0°F	0.1°C (°F)	N	-200 to 1300°C	-328 to 2372°F	1°C (°F)	PL-II	0 to 1390°C	32 to 2534°F	1°C (°F)	C(W/Re5-26)	0 to 2315°C	32 to 4199°F	1°C (°F)	
	Type	Measurement Range	Input Value of LSB																																														
	K	-200 to 1370°C	-328 to 2498°F	1°C (°F)																																													
	K (with decimal point)	-200.0 to 400.0°C	-328.0 to 752.0°F	0.1°C (°F)																																													
	J	-200 to 1000°C	-328 to 1832°F	1°C (°F)																																													
	R	0 to 1760°C	32 to 3200°F	1°C (°F)																																													
	S	0 to 1760°C	32 to 3200°F	1°C (°F)																																													
	B	0 to 1820°C	32 to 3308°F	1°C (°F)																																													
	E	-200 to 800°C	-328 to 1472°F	1°C (°F)																																													
	T	-200.0 to 400.0°C	-328.0 to 752.0°F	0.1°C (°F)																																													
	N	-200 to 1300°C	-328 to 2372°F	1°C (°F)																																													
	PL-II	0 to 1390°C	32 to 2534°F	1°C (°F)																																													
	C(W/Re5-26)	0 to 2315°C	32 to 4199°F	1°C (°F)																																													
	Resistance Thermometer																																																
	<table border="1"> <thead> <tr> <th>Type</th> <th>Measurement Range</th> <th>Input Value of LSB</th> </tr> </thead> <tbody> <tr> <td>Pt100</td> <td>-200 to 850°C</td> <td>-328 to 1562°F</td> <td>1°C (°F)</td> </tr> <tr> <td>Pt100 (with decimal point)</td> <td>-200.0 to 850.0°C</td> <td>-328.0 to 1562.0°F</td> <td>0.1°C (°F)</td> </tr> <tr> <td>JPt100</td> <td>-200 to 500°C</td> <td>-328 to 932°F</td> <td>1°C (°F)</td> </tr> <tr> <td>JPt100(with decimal point)</td> <td>-200.0 to 500.0°C</td> <td>-328.0 to 932.0°F</td> <td>0.1°C (°F)</td> </tr> </tbody> </table>	Type	Measurement Range	Input Value of LSB	Pt100	-200 to 850°C	-328 to 1562°F	1°C (°F)	Pt100 (with decimal point)	-200.0 to 850.0°C	-328.0 to 1562.0°F	0.1°C (°F)	JPt100	-200 to 500°C	-328 to 932°F	1°C (°F)	JPt100(with decimal point)	-200.0 to 500.0°C	-328.0 to 932.0°F	0.1°C (°F)																													
	Type	Measurement Range	Input Value of LSB																																														
	Pt100	-200 to 850°C	-328 to 1562°F	1°C (°F)																																													
	Pt100 (with decimal point)	-200.0 to 850.0°C	-328.0 to 1562.0°F	0.1°C (°F)																																													
	JPt100	-200 to 500°C	-328 to 932°F	1°C (°F)																																													
JPt100(with decimal point)	-200.0 to 500.0°C	-328.0 to 932.0°F	0.1°C (°F)																																														
Current/Voltage																																																	
<table border="1"> <thead> <tr> <th>Type</th> <th>Measurement Range</th> <th>Input Value of LSB</th> </tr> </thead> <tbody> <tr> <td>4 to 20mA DC</td> <td>-2000 to 10000 (12000 increments) *1</td> <td>1.333μ</td> </tr> <tr> <td>0 to 20mA DC</td> <td>-2000 to 10000 (12000 increments) *1</td> <td>1.666μA</td> </tr> <tr> <td>0 to 1V DC</td> <td>-2000 to 10000 (12000 increments) *1</td> <td>0.083mV</td> </tr> <tr> <td>0 to 5V DC</td> <td>-2000 to 10000 (12000 increments) *1</td> <td>0.416mV</td> </tr> <tr> <td>1 to 5V DC</td> <td>-2000 to 10000 (12000 increments) *1</td> <td>0.333mV</td> </tr> <tr> <td>0 to 10V DC</td> <td>-2000 to 10000 (12000 increments) *1</td> <td>0.833mV</td> </tr> </tbody> </table>	Type	Measurement Range	Input Value of LSB	4 to 20mA DC	-2000 to 10000 (12000 increments) *1	1.333μ	0 to 20mA DC	-2000 to 10000 (12000 increments) *1	1.666μA	0 to 1V DC	-2000 to 10000 (12000 increments) *1	0.083mV	0 to 5V DC	-2000 to 10000 (12000 increments) *1	0.416mV	1 to 5V DC	-2000 to 10000 (12000 increments) *1	0.333mV	0 to 10V DC	-2000 to 10000 (12000 increments) *1	0.833mV																												
Type	Measurement Range	Input Value of LSB																																															
4 to 20mA DC	-2000 to 10000 (12000 increments) *1	1.333μ																																															
0 to 20mA DC	-2000 to 10000 (12000 increments) *1	1.666μA																																															
0 to 1V DC	-2000 to 10000 (12000 increments) *1	0.083mV																																															
0 to 5V DC	-2000 to 10000 (12000 increments) *1	0.416mV																																															
1 to 5V DC	-2000 to 10000 (12000 increments) *1	0.333mV																																															
0 to 10V DC	-2000 to 10000 (12000 increments) *1	0.833mV																																															
*1: Linear conversion possible																																																	
Input	Input type																																																
	Thermocouple	K, J, R, S, B, E, T, N, PL-II, C (W/Re5-26) External resistance: 100Ω maximum However, B input, External resistance: 40Ω maximum																																															
	Resistance Thermometer	Pt100, JPt100, 3-wire type Allowable conductor resistance (per wire): 10Ω maximum Sensor (detection) current: 0.2A																																															
	Current	0 to 20mA DC, 4 to 20mA DC Input impedance: 50Ω Maximum permanent allowed overload (No damage): 50mA maximum																																															
	Voltage	0 to 1V DC Input impedance: 1MΩ minimum Maximum permanent allowed overload (No damage): 5V DC maximum Allowable output impedance: 2kΩ maximum 0 to 5V DC, 1 to 5V DC, 0 to 10V DC Input impedance: 100kΩ minimum Maximum permanent allowed overload (No damage): 15V DC maximum Allowable output impedance: 100Ω maximum																																															
Power Supply Voltage	24V DC (External power), 5V DC (Internal power)																																																
Allowable Voltage Range	20.4 to 28.8V DC																																																

General Specifications

Type No.	FC5A-F2MR2	FC5A-F2M2
Connector	Connector on Mother Board	Input : F6018-17P (Fujicon) Output: F6018-11P (Fujicon)
	Connector Insertion/Removal Durability	—

Input Specifications

Type No.	FC5A-F2MR2	FC5A-F2M2
Maximum Error at 25°C	Thermocouple	±0.2% of full scale or ±2°C (4°F), whichever is greater However, R, S inputs, 0 to 200°C (0 to 400°F): ±6°C (12°F) B input, 0 to 300°C (0 to 600°F): Accuracy is not guaranteed. K, J, E, T, N inputs, Less than 0°C (32°F): ±0.4% of full scale
	Resistance Thermometer	±0.1% of full scale or ±1°C (2°F), whichever is greater
	Voltage, Current	±0.2% of full scale
Input Accuracy (at 0 to 55°C)	Thermocouple	±0.7% of full scale However, R, S input, 0 to 200°C (0 to 400°F): ±6°C (12°F) B input, 0 to 300°C (0 to 600°F): Accuracy is not guaranteed. K, J, E, T, N inputs, Less than 0°C (32°F): ±0.9% of full scale
	Resistance Thermometer	±0.6% of full scale
	Voltage, Current	±0.7% of full scale
Data Accuracy	Maximum error at 25°C±Minimum digital resolution of each input range	
Cold Junction Temperature Compensation Accuracy	±1°C at 0 to 55°C	
Sampling Period	125 ms	

Output Specifications

Type No.	FC5A-F2MR2	FC5A-F2M2
Control Output	Relay output 1a Rated load: 5A 250V AC (resistive load) 5A 30V DC (resistive load) 3A 250V AC (inductive load cosφ=0.4)	Non-contact voltage (for SSR drive) 12V DC±15% Current : 4 to 20mA DC

Program Control Specifications

Type No.	FC5A-F2MR2	FC5A-F2M2
Time Setting Accuracy	±0.5% of setting time	
Progressing Time Error After Power is Restored	Maximum 6 minutes	
Non-volatile Memory Write Limit	1,000,000 times	

Insulation, Dielectric Strength

Insulation, Dielectric Strength

Type No.	FC5A-F2MR2	FC5A-F2M2
Isolation	Photocoupler-isolated between input and internal circuit Photocoupler-isolated between input and power circuit Photocoupler-isolated between input and internal circuit Photocoupler-isolated between output and internal circuit	
Dielectric Strength	Output terminal - External power: 1500kV AC 5mA for 1 minute Output terminal - Internal power: 1500kV AC 5mA for 1 minute Input power - Output power: 1500kV AC 5mA for 1 minute FG - External power: 548V AC 5mA for 1 minute Input terminal - External power: 548V AC 5mA for 1 minute Input terminal - Internal power: 548V AC 5mA for 1 minute Output terminal - External power: 2500V AC 5mA for 1 minute Output terminal - Internal power: 2500V AC 5mA for 1 minute External power - Internal power: 548V AC 5mA for 1 minute Input terminal - Output terminal: 548V AC 5mA for 1 minute	FG - External power: 548V AC 5mA for 1 minute I/O terminal - External power: 548V AC 5mA for 1 minute I/O terminal - Internal power: 548V AC 5mA for 1 minute External power - Internal power: 548V AC 5mA for 1 minute Input terminal - Output terminal: 548V AC 5mA for 1 minute

Other

Type No.	FC5A-F2MR2	FC5A-F2M2
Power Consumption	Approx. 3.5W maximum	
Module Power Consumption (Interior)	5V DC	65mA
	24V DC	0mA
Ambient Temperature	0 to 55°C (No icing)	
Ambient Humidity	10 to 95%RH (Non-condensing)	
Weight	Approx. 140g	
Environmental Specifications	Conforms to RoHS directive.	
Recommended Cable	Twisted pair cable	

Dimensions

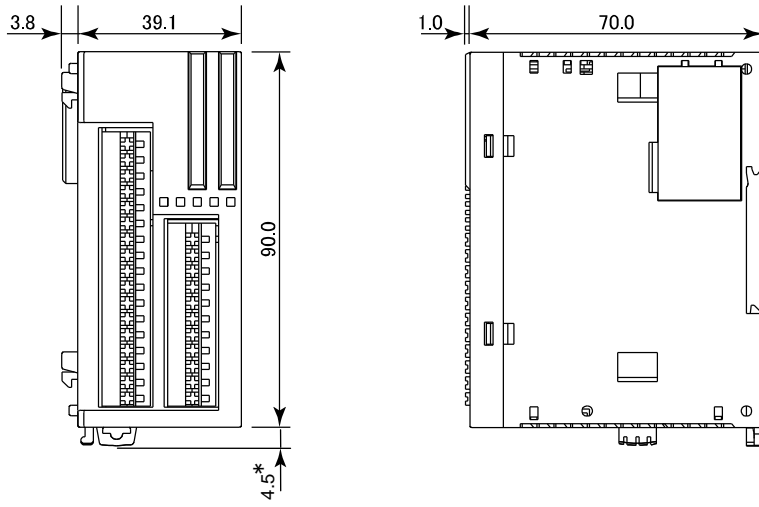

(All dimensions in mm)
* 8.5mm when the clamp is pulled out

3: INSTALLATION AND WIRING

This chapter describes how to install and wire the PID modules. For general methods and precautions for installation and wiring of the PID modules, see chapter 3 in the FC5A MicroSmart user's manual (FC9Y-B1268). Be sure to use the PID modules properly after understanding installation and wiring thoroughly.



Caution

- Assemble the CPU module and PID modules before installing them on a DIN rail. Otherwise, they may break.
- Do not lay out or wire the modules while power is supplied to them. Otherwise, they may be damaged.
- When installing modules, follow the instructions described in the FC5A MicroSmart user's manual. If there are flaws in the installation, it may cause disattachment, failure or malfunction.

Mounting Hole Layout for Direct Mounting on Panel Surface

To mount the PID module on a panel surface, use the direct mounting strip and two M4 screws (6 or 8 mm long).

For details about the direct mounting strip, see the FC5A MicroSmart user's manual (FC9Y-B1268).

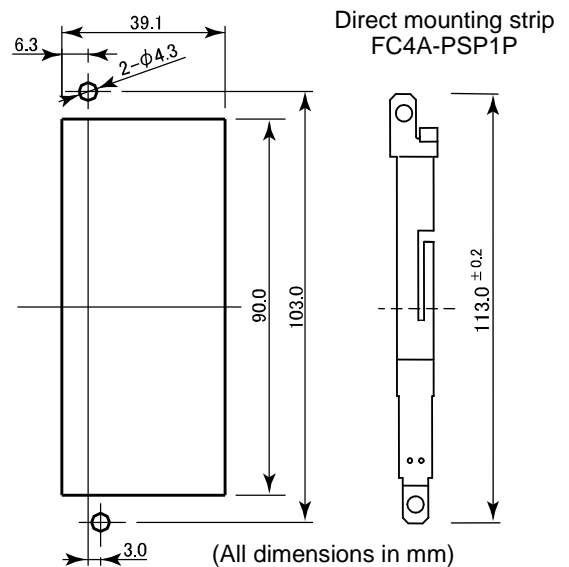

Example: Mounting hole layout for FC5A-C24R2 and four PID modules

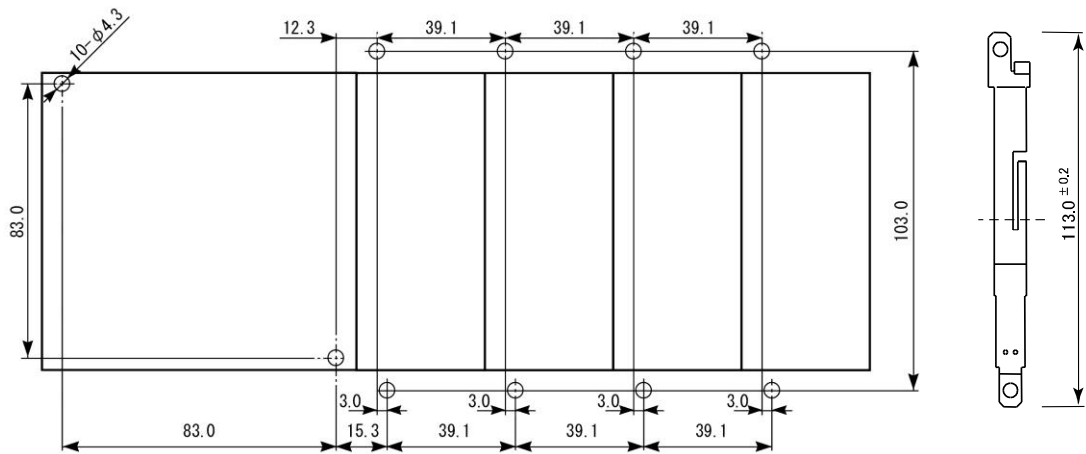

(All dimensions in mm)

Terminal Connection



Caution

- Make sure that the operating conditions and environments are within the specified values.
- Be sure to connect the grounding wire to a proper ground, otherwise electrical shocks may be caused.
- Do not touch live terminals, otherwise electrical shocks may be caused.
- Do not touch terminals immediately after power is turned off, otherwise electrical shocks may be caused.
- When using ferrules, insert a wire to the bottom of the ferrule and crimp the ferrule.
- When connecting a stranded wire or two solid wires to single-pole terminal block, be sure to use a ferrule. Otherwise the wire may slip off the terminal block.

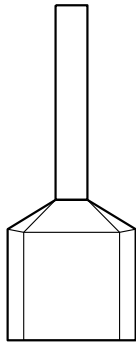

Ferrule for Terminal block

To cramp the following ferrules, use the specified crimping tool (CRIMPFOX ZA 3).

For 1-cable connection

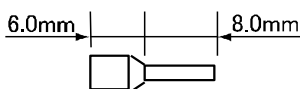

For 2-cable connection

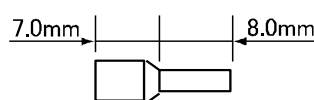

For 1-cable connection

Phoenix Type	Cable Size
AI 1-8 RD	UL1007AWG18
AI 0.5-8 WH	UL1015AWG22

For 2-cable connection

Phoenix Type	Cable Size
AI-TWIN2x0.75-8 GY	UL1007AWG18
AI-TWIN2x0.5-8 WH	UL1015AWG22

Note: The above ferrules, crimping tool, and screwdriver are made by Phoenix Contact and are available from Phoenix Contact.

Terminal Arrangement



Caution

- Connect an IEC 60127-approved fuse appropriate for the applied voltage and current draw, at the position shown in the diagram. (This is required when equipment containing the MicroSmart is destined for Europe.)
- Do not connect a thermocouple to hazardous voltage (60V DC, 42.4V DC peak or higher).
- Be sure to check the wiring before the power is turned on. Faulty wiring may result in damage to the PID module.
- Applicable electric cables are listed below.
 Cable size AWG16: Single-cable
 Cable size AWG18, AWG22: Single-cable/Twisted cable

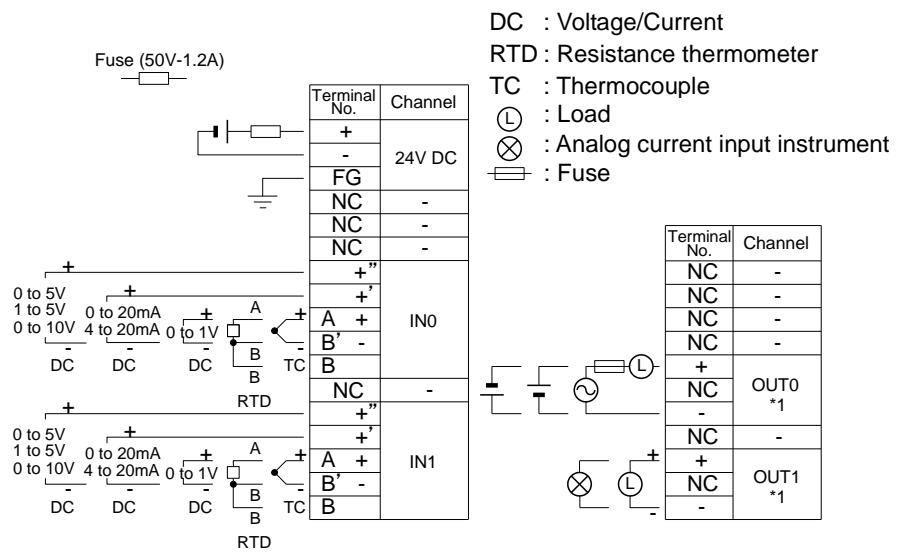
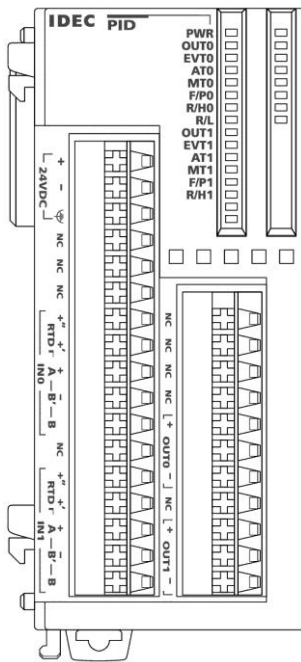

*1: OUT0 is a connection example of relay output.

OUT1 is a connection example of non-contact voltage/current output. The PID module having both outputs is non-existent.

Type of Protection

Input Circuits

FC5A-F2MR2, FC5A-F2M2

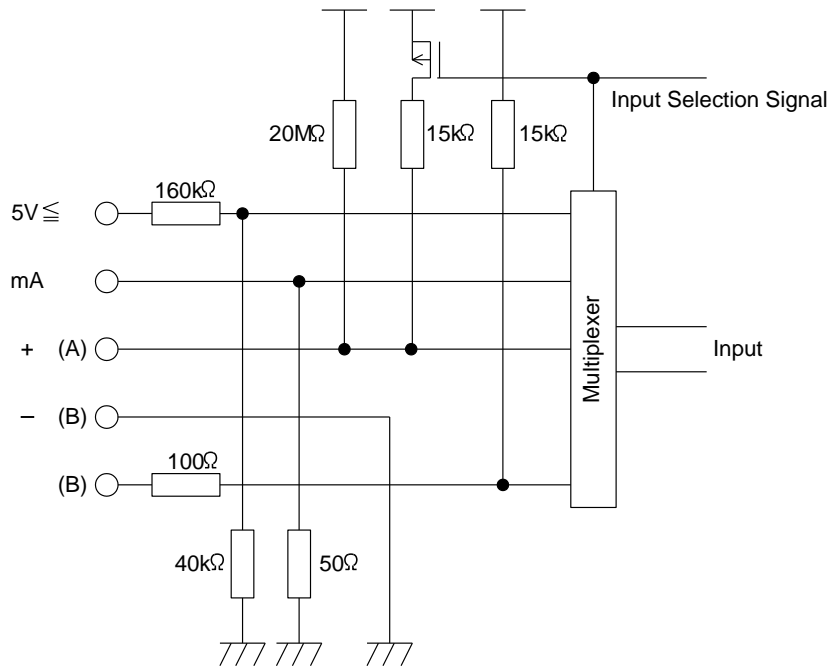

Output Circuits

FC5A-F2MR2

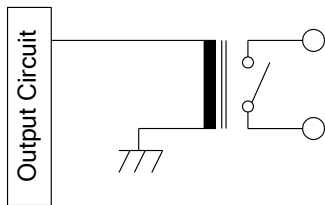

FC5A-F2M2 [Non-contact Voltage Output (for SSR drive)]

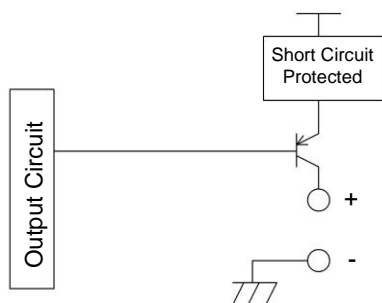

FC5A-F2M2 (Current Output)

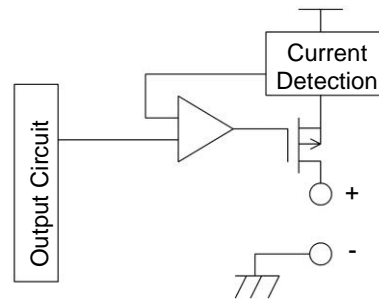

Power Supply for PID Modules

When supplying power to the PID modules, take the following into consideration.

Using the same power supply for the MicroSmart CPU and the PID module is recommended to suppress the influence of noise. If the same power source is used for the PID module and MicroSmart CPU module, after the MicroSmart CPU is started to run, the PID module performs initialization for a maximum of 5 seconds. During this period, each parameter has an indefinite value. Design the user program to make sure that each parameter is referred in the CPU module after the PID module operating status is changed to 0001h (Normal operation).

Wiring of Power Line and I/O Lines for the PID Module

Separate the I/O lines, particularly resistance thermometers, from the power line as much as possible to suppress the influence of noise.

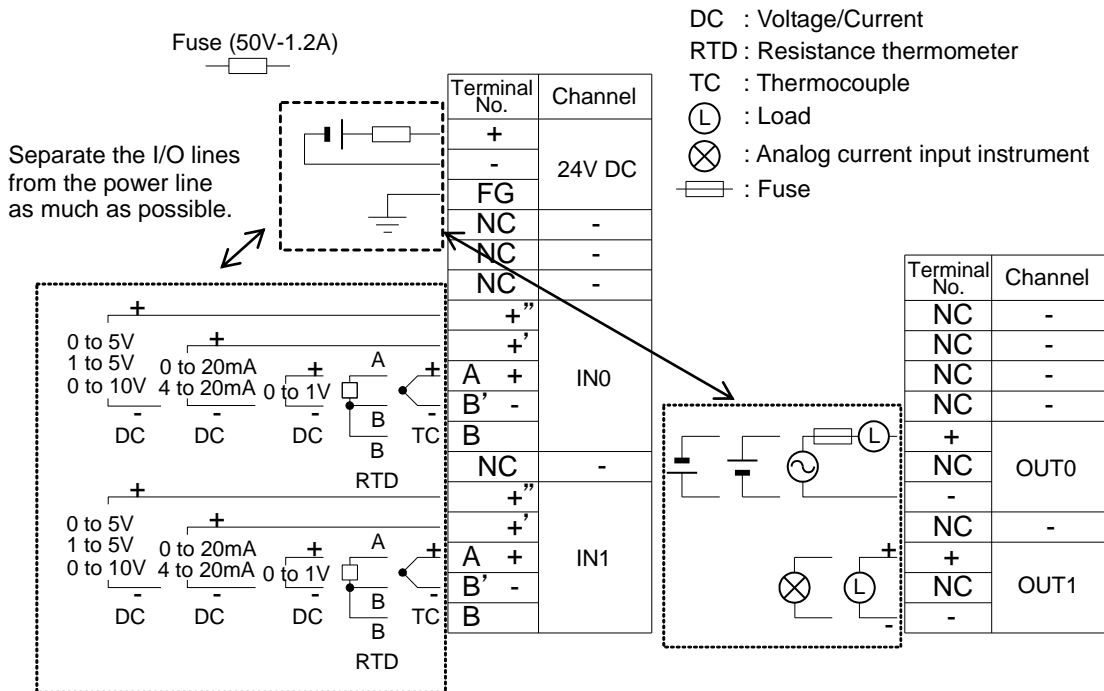

4: PID MODULE MAIN FUNCTIONS

This chapter describes the temperature control, fixed value control, auto-tuning (AT), program control, heating/cooling control, difference input control, and cascade control of the PID module.

Temperature Control Using the PID Module

Temperature Control Configuration Example Using the PID Module

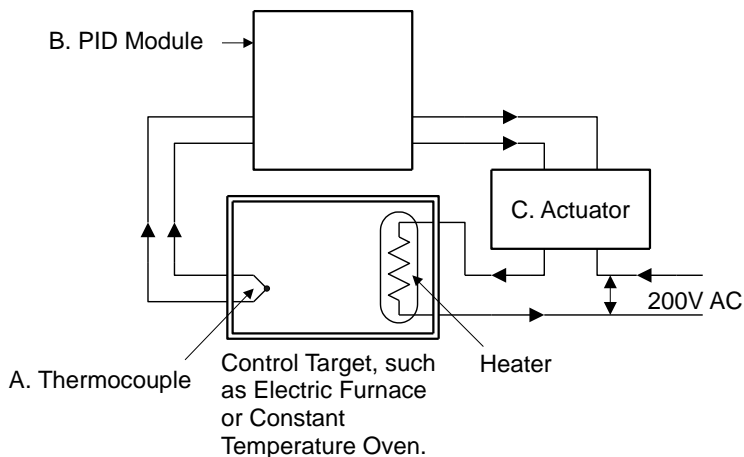

A. Sensor

Measures temperature of the control target. Thermocouple, resistance thermometer, voltage input, or current input can be used as the sensor.

B. PID module

Receives the temperature measured by the sensor as the process variable (PV), and calculates the output manipulated variable (MV) so that temperature difference (deviation) between the process variable (PV) and the set point (SP) can be eliminated. The output manipulated variable (MV) is outputted to the actuator as a control signal. Relay output, non-contact voltage output, or current output can be used as the control signal.

C. Actuator

Receives a control signal from the PID module and turns on the load power supply to the heater. Electromagnetic switches, SSR, or power controllers can be used as the actuator.

Optimal Temperature Control

The ideal temperature control, as shown in Figure 1, is to control the temperature to correspond with the set point (SP) regardless of any disturbances. There should be no overshoot or response delay of time until the temperature reaches the set point (SP).

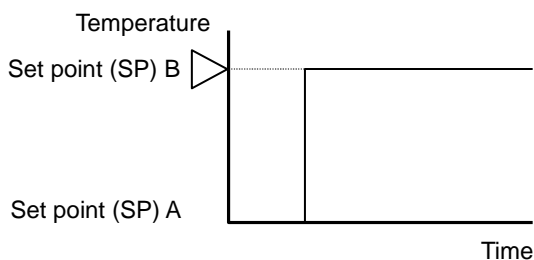

Figure 1. Ideal Temperature Control

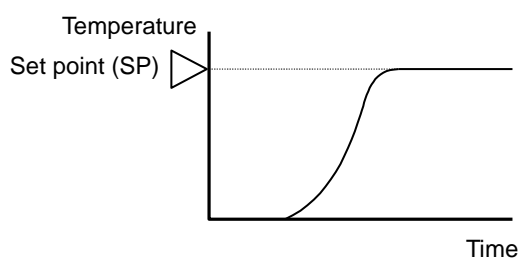

Figure 2. Optimal Temperature Control

In reality, the ideal temperature control shown in Figure 1 on the previous page is almost impossible to achieve due to a number of complicated factors such as thermal capacity, static characteristics, dynamic characteristics and disturbances.

Figure 2 is regarded as an optimal temperature control result. Depending on the usage and objective, for some temperature control applications, suppression of overshoot is required even if the temperature rises very slowly as shown in Figure 3. For some temperature control applications, it is necessary to stabilize the temperature as quickly as possible by raising the temperature rapidly even if overshoot is generated as shown in Figure 4. In general, however, Figure 2 is regarded as an optimal temperature control. The PID module is designed to raise the process variable (PV) to the set point (SP) as quickly as possible in order to stabilize the process variable (PV) at the set point (SP) so as to perform the optimal temperature control. If the temperature fluctuates due to sudden disturbances, the PID module responds to the fluctuation with speedy response in the shortest possible time and performs quick control to stabilize the temperature.

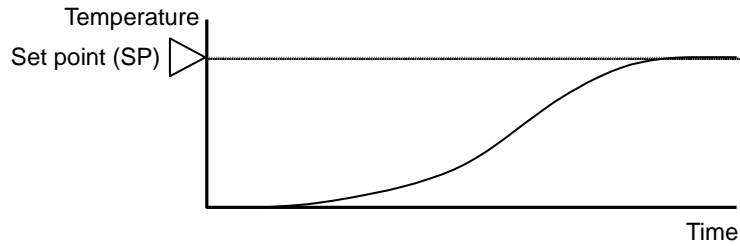

Figure 3. Stable but slow temperature rise control

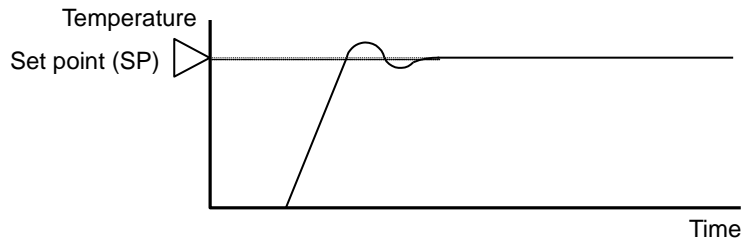

Figure 4. The temperature rises rapidly; however, the control stabilizes after overshoot and undershoot.

Characteristics of the Control Target

To perform optimal temperature control, it is necessary to have a good knowledge of the thermal characteristics of the PID module, sensors, actuators as well as control targets. For example, the PID module controls a constant temperature oven and its temperature can rise up to 100°C. Even if the set point (SP) of the PID modules is configured as 200°C, the temperature of the constant temperature oven rise only up to 100 °C due to its static characteristic.

The characteristic of the control target is determined by the combination of the following 4 factors.

1. Thermal capacity:

This represents how the target is easily heated, and has a relation with the volume size of the control target.

2. Static characteristic:

This represents the capability of heating, and is determined by the size of the heater capacity.

3. Dynamic characteristic:

This represents the rising characteristic (transitional response) during initial heating. This is a complicated process involving heater capacity, furnace capacity size and sensor location.

4. Disturbance:

Any change in control temperature causes disturbance. For example, the change of ambient temperature or supply voltage can cause disturbance.

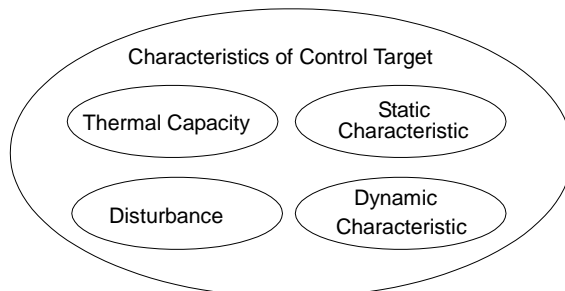

Fixed Value Control

The PID module provides 2 control modes, one is the fixed value control and the other is the program control. The fixed value control is a standard temperature control which performs to eliminate the deviation between the single set point (SP) and process variable (PV). The program control allows you to define the set point (SP) that changes as the time progresses so that the process variable (PV) can be controlled to match the set point (SP) changing as the time progresses. For detail about the program control, see 4-9. Control actions that can be used for fixed value control and program control are described below.

ON/OFF Control Action

In the ON/OFF control action, when the process variable (PV) is lower than the set point (SP), the control output is turned on, and when the process variable (PV) exceeds the set point (SP), the control output is turned off. Overshoot, undershoot, and hunting are generated. ON/OFF control is suitable for processes which do not require accuracy.

If the proportional band or proportional gain of the PID module parameter is set to 0, the control action becomes ON/OFF control.

Overshoot, Undershoot

As the temperature of the control target rises as shown in the figure on the right, the process variable (PV) sometimes exceeds the set point (SP) greatly. This is called overshoot. If the process variable (PV) drops below the set point (SP), this is called undershoot.

Hunting

The control result oscillates as shown in the figure on the right. This is the hunting.

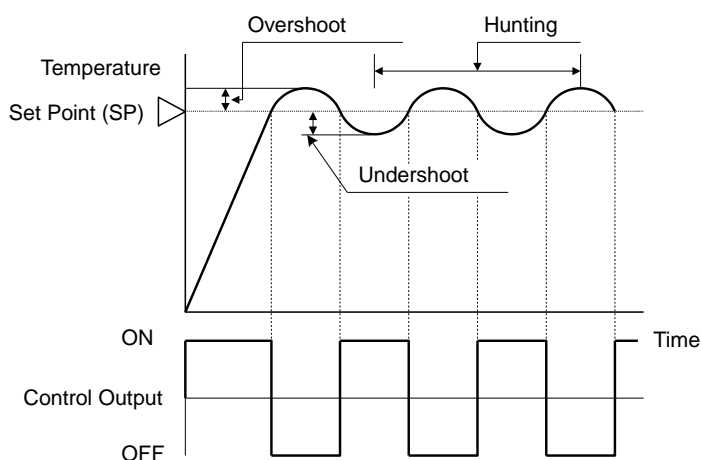

P Control Action (Proportional Action)

P control action outputs the manipulated variable (MV) in proportion to the deviation between the process variable (PV) and the set point (SP) within the proportional band. The control output is ON until the process variable (PV) reaches the point A that is determined by the proportional band. If the process variable (PV) exceeds the point A (enters the proportional band), the control output starts turn on/off according to the control period and the manipulated variable (MV). If the process variable (PV) exceeds the set point (SP), the control output is completely turned off. While the process variable (PV) rises from the point A to the set point (SP), the control output ON time decreases and the control output OFF time increases. Compared to ON/OFF control action, there is no overshoot in P control action, and hunting becomes less frequent; however, the offset is generated. The P control action is suitable for processes such as gas pressure control or level control, in which there is no dead time.

If the integral time and derivative time of the PID module parameter are set to 0, the control action becomes the P control action.

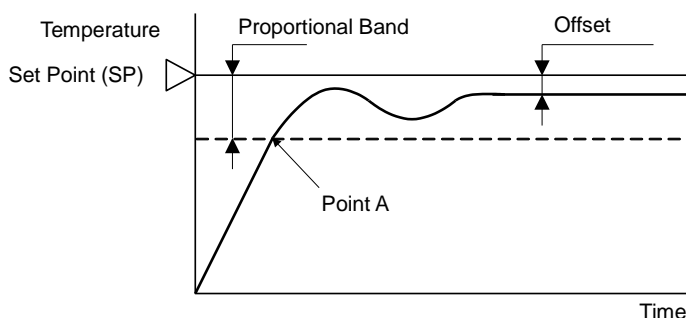

- If the proportional band is narrowed (Proportional gain is made larger)
Because the control output starts turning on/off at around the set point (SP), the time until the process variable (PV) reaches the set point (SP) is shortened, and the offset is small; however, hunting is frequent. If the proportional band is greatly narrowed, the control action becomes similar to the ON/OFF control action.
- If the proportional band is broadened (Proportional gain is made smaller)
Because the control output starts turning on/off at the significantly low temperature from the set point (SP), overshoot or hunting is reduced; however, it takes time for the process variable (PV) to reach to the set point (SP), and the offset between the process variable (PV) and the set point (SP) becomes broadened.

The offset caused by the P control action can be corrected by configuring the reset value. If the reset value is configured, the proportional band range can be shifted as shown in the figure below. The reset value can be automatically calculated by the auto-reset function.

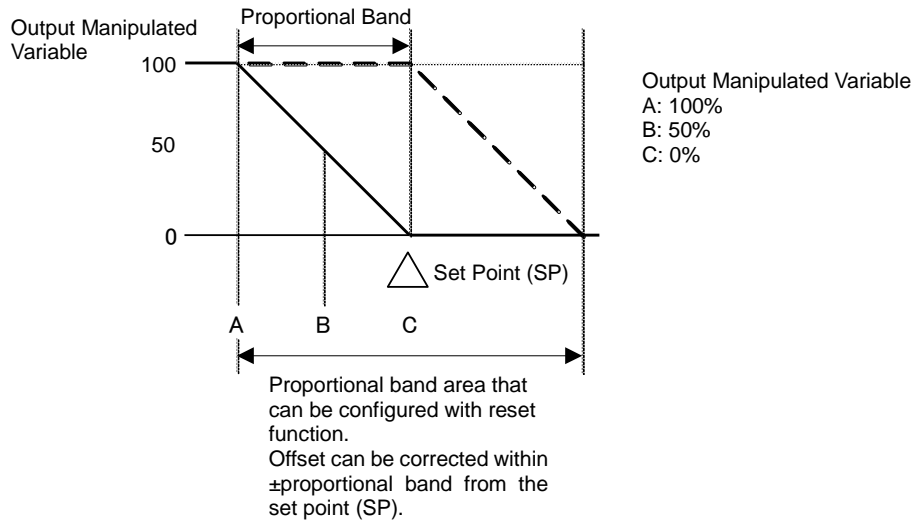

PI Control Action (Proportional + Integral Action)

I (Integral) action automatically corrects the offset caused by P control action, and temperature control is performed at the set point (SP). However, it takes time for the process variable (PV) to be stable if the process variable (PV) is changed rapidly due to disturbance. PI control action is suitable for the processes in which the temperature slowly changes.

If the derivative time of the PID module parameter is set to 0, the control action becomes the PI control action.

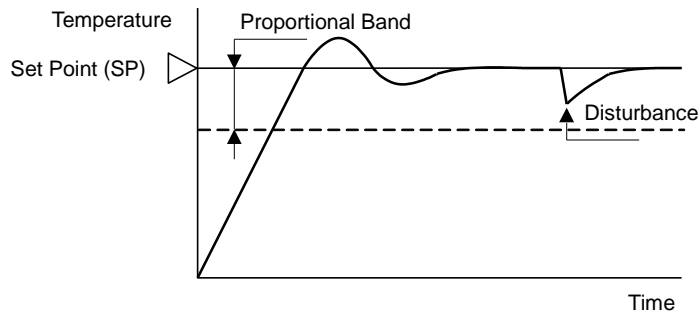

- If the integral time is shortened too much, the integral action becomes strong. The offset can be corrected in a shorter time; however, hunting with a long cycle may be caused.
- If the integral time is extended too much, the integral action becomes weak and it takes time to correct the offset.

PD Control Action (Proportional + Derivative Action)

Compared with P action, the response to rapid temperature change due to disturbance is faster, the temperature control can be stabilized in a shorter time, and transitional response characteristic can be improved in PD control action. PD control action is suitable for the processes in which the temperature rapidly changes.

If the integral time of the PID module parameter is set to 0, the control action becomes the PD control action.

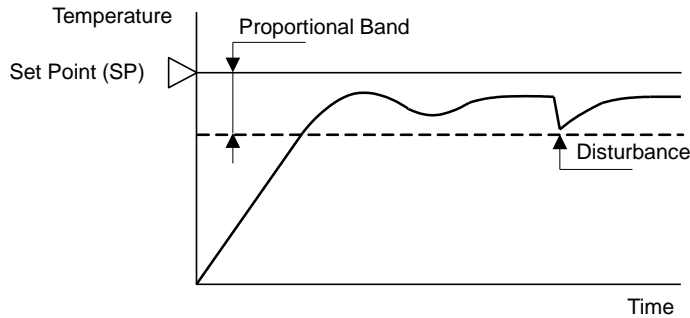

- If the derivative time is shortened, the derivative action becomes weak. The response to the rapid temperature change becomes slower. Because the action to suppress the rapid temperature rises becomes weaker, the time for the process variable (PV) to reach the set point (SP) is shortened; however, overshoot can occur.
- If the derivative time is extended, the derivative action becomes strong. The response to the rapid temperature change becomes faster. Because the action to suppress the rapid temperature rises becomes strong, the time for the process variable (PV) to reach the set point (SP) is extended; however, overshoot can be decreased.

The offset caused by the PD control action can be corrected by configuring the reset value. The reset value can be automatically calculated by the auto-reset function.

PID Control Action (Proportional + Integral + Derivative Action)

P action suppresses the overshoot and the hunting, I action corrects the offset, and D action corrects rapid temperature change due to disturbance in shorter time. Thus, using PID control action, optimal temperature control can be performed. The proportional band, integral time, derivative time, and ARW can be automatically calculated by the auto-tuning (AT).

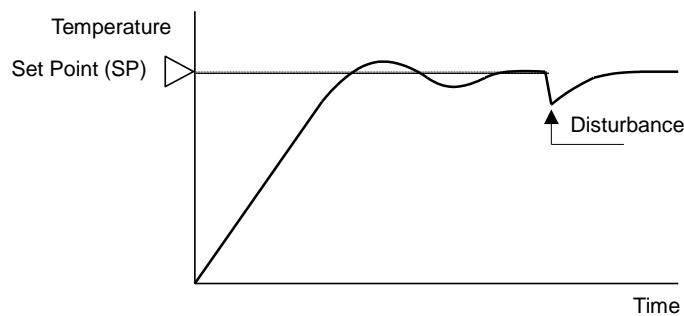

Auto-Tuning (AT)/Auto-Reset

The optimal temperature control parameters differ depending on the characteristics of the process to control. For PID control action, the proportional band, integral time, derivative time, and ARW are automatically configured by performing auto-tuning (AT). For P control or PD control action, the reset value is automatically configured by performing auto-reset.



Caution

- Perform auto-tuning (AT)/auto-reset during the trial run.
- If the auto-tuning (AT) is performed near the ambient temperature, sufficient fluctuations cannot be given to the process, and auto-tuning (AT) may fail. In such case, configure the P, I, D, and ARW values manually.
- Perform auto-reset when the process variable (PV) is stabilized within the proportional band.
- Once auto-tuning (AT)/auto-reset is performed, it is unnecessary to perform auto-tuning (AT)/auto-reset again as long as the process is unchanged.
- When voltage or current input is selected and the auto-tuning (AT) is performed, fluctuations are given to the process at the set point (SP) regardless of AT bias.
- During program control, fluctuations are given to the process as soon as auto-tuning (AT) is started.

Auto-tuning (AT)

In order to configure P (proportional band), I (integral time), D (derivative time), and ARW (Anti-Reset Windup) automatically with optimal values, the auto-tuning (AT) can be performed. The auto-tuning (AT) gives temperature fluctuation to the process to calculate those parameters. To perform an optimal auto-tuning (AT), temperature fluctuation is given to the process when the process variable (PV) reaches near the set point (SP). By setting the AT bias, the temperature to start giving fluctuation can be configured. The relation between the set point (SP), AT bias, auto-tuning (AT) starting point, and fluctuation starting point are shown below.

[Process variable (PV) ≤ Set point (SP) - AT bias value]

When AT bias is set to 20°C, the PID module starts giving the temperature fluctuation to the process at the temperature 20°C lower from the set point (SP).

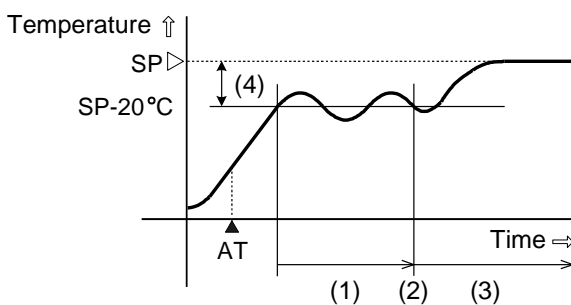

- (1) Fluctuation period. PID parameters are measured.
- (2) PID parameters are calculated and auto tuning (AT) is finished.
- (3) Temperature is controlled with the PID parameters configured with auto-tuning (AT).
- (4) AT bias value (20°C)

▲ AT: Auto-tuning (AT) perform bit is turned on

[Set point (SP) - AT bias value < Process variable (PV) < Set point (SP) + AT bias value]

The PID module starts giving the temperature fluctuation to the process when the process variable (PV) reaches the set point (SP).

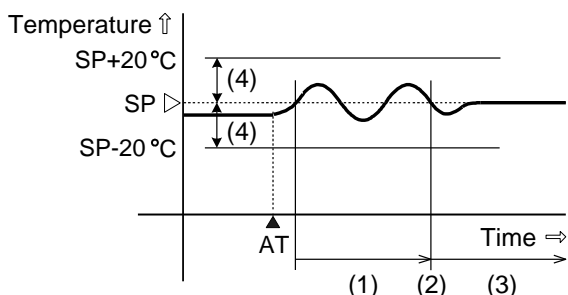

- (1) Fluctuation period. PID parameters are measured.
- (2) PID parameters are calculated and auto tuning (AT) is finished.
- (3) Temperature is controlled with the PID parameters configured with auto-tuning (AT).
- (4) AT bias value (20°C)

▲ AT: Auto-tuning (AT) perform bit is turned on

[Process variable (PV) ≥ Set point (SP) + AT bias value]

When AT bias is set to 20°C, the PID module starts giving the temperature fluctuation to the process at the temperature 20°C higher from the set point (SP).

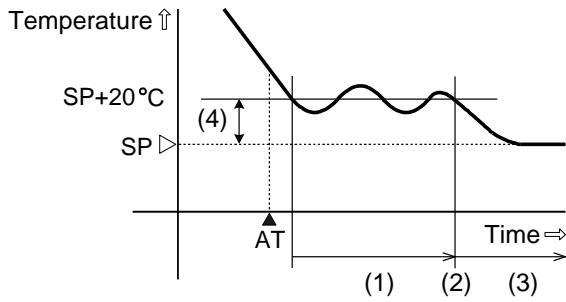

- (1) Fluctuation period. PID parameters are measured.
- (2) PID parameters are calculated and auto tuning (AT) is finished.
- (3) Temperature is controlled with the PID parameters configured with auto-tuning (AT).
- (4) AT bias value (20°C)

▲ AT: Auto-tuning (AT) perform bit is turned on

Auto-reset

During the P control or PD control action, the deviation (offset) between the process variable (PV) and the set point (SP) is generated when the process variable (PV) is stabilized. By performing auto-reset, the reset value can automatically be calculated to correct the offset. It is required to perform auto-reset when the process variable (PV) is stabilized within the proportional band. When the auto-reset is completed, the CPU module automatically reads all parameters including the calculated reset value from the PID module and stores those parameters in the data registers. It is unnecessary to perform the auto-reset again as long as the process is unchanged.

When the proportional band (P) is set to 0 or 0.0, the reset value is cleared.

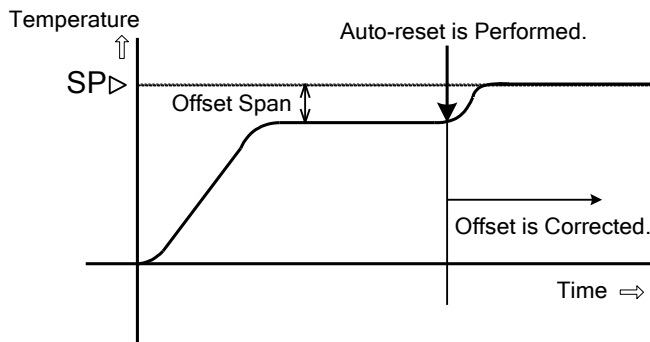

Auto-tuning (AT)/Auto-reset Perform/Cancel

The Auto-tuning (AT)/Auto-reset function can be performed or cancelled by turning on/off the operation parameter bits allocated to each channel. For the operation parameter bits, see page 5-10.

Perform Auto-tuning (AT)

To perform auto-tuning (AT), turn on the control enable/disable bit (Bit0) and auto-tuning (AT)/auto-reset bit (Bit1) of the operation parameter. P, I, D and ARW values will automatically be configured.

When auto-tuning (AT) is performed during the program control, P, I, D and ARW values of the current step are configured. While auto-tuning (AT) is performed, the Auto-tuning (AT)/Auto-reset LED (AT0/AT1) flashes.

When auto-tuning (AT) is completed, the operation parameter Bit1 is automatically turned off, and the CPU module reads all parameters of the AT performed channel from the PID module and store those parameters in the data registers. If any parameters in the data registers of the CPU module have been changed but have not been written to the PID module, those parameters will be overwritten with the parameters read from the PID module when auto-tuning (AT) is finished.

Cancel Auto-tuning (AT)

To cancel auto-tuning (AT) while it is performed, turn off Auto-tuning (AT)/Auto-reset bit (Bit1) of the operation parameter. When the operation parameter Bit1 is turned off, auto-tuning (AT) is canceled, and the Auto-tuning (AT)/Auto-reset LED (AT0/AT1) will go off. When auto-tuning (AT) is cancelled, P, I, D and ARW values are reverted to the original values at the time that auto-tuning (AT) was started.

Perform Auto-reset

To perform auto-reset, turn on Auto-tuning (AT)/Auto-reset bit (Bit1) of the operation parameter. The reset value will automatically be configured and the offset is corrected. During auto-reset is performed, the Auto-tuning (AT)/Auto-reset LED (AT0/AT1) flashes.

Auto-reset cannot be cancelled.

Auto-tuning (AT)/Auto-reset Program Example

The ladder program and the timing chart below describe an example of performing and canceling auto-tuning (AT)/auto-reset of CH0. In this example, D1000 is allocated to the control register and M1000 is allocated to control relay.

Ladder Program

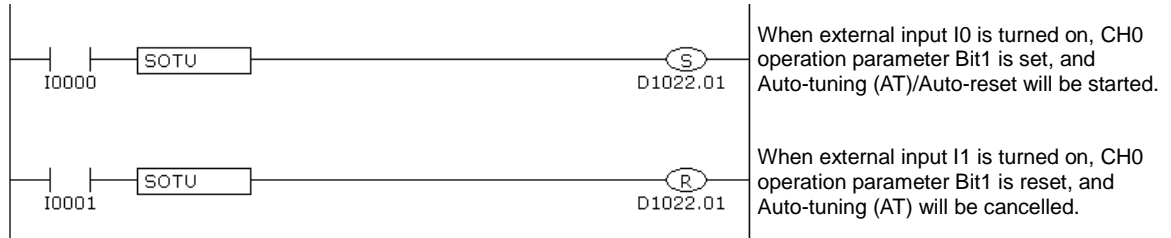

Timing Chart

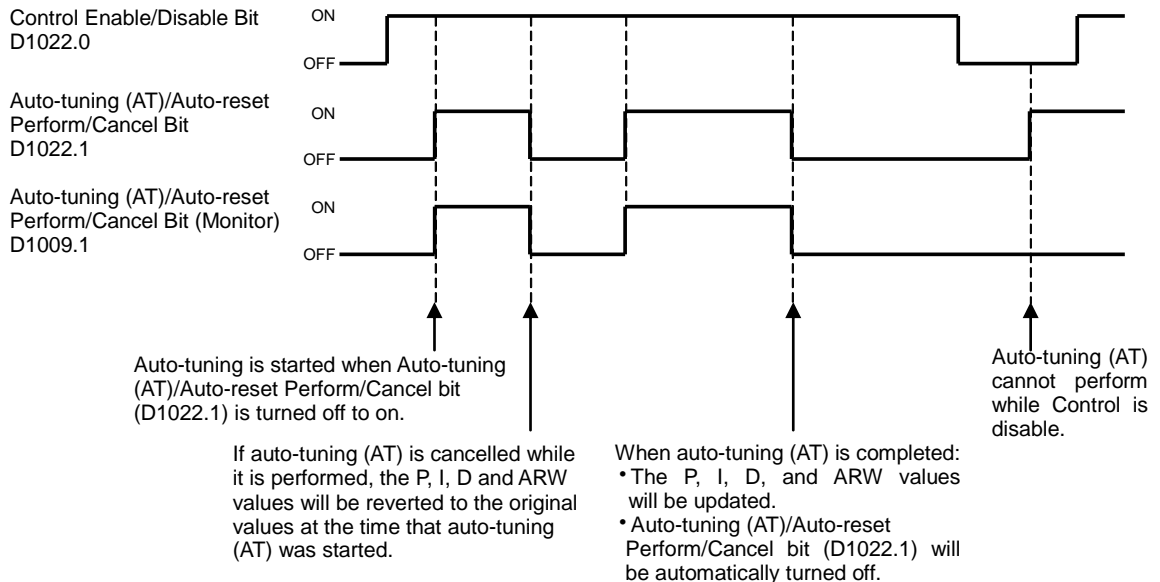

Notes

- Auto-tuning (AT)/Auto-reset bit is automatically turned off when Auto-tuning (AT)/Auto-reset is completed.
- If Auto-tuning (AT)/Auto-reset bit is kept on, Auto-tuning (AT)/Auto-reset will be performed continuously. Use SOTU and SET instructions to turn on Auto-tuning (AT)/Auto-reset bit so that auto-tuning (AT)/auto-reset is performed only once.
- If auto-tuning (AT) is cancelled while it is performed, P, I, D, and ARW values will be reverted to the original values at the time that auto-tuning (AT) was started.
- Auto-reset cannot be cancelled.

Program Control

The program control allows you to define the set point (SP) that changes as the time progresses so that the process variable (PV) can be controlled to match the set point (SP) changing as the time progresses. The set point (SP) and time can be configured for each step. A maximum of 10 steps can be configured and performed. The set point (SP) can be configured as shown in the following diagram. The program control is suitable for applications, such as electric furnaces for ceramic industries or food machineries.

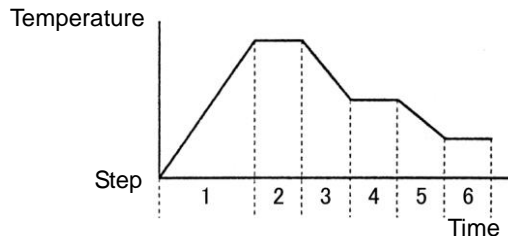

Main functions of the program control are described as follows:

Program Pattern and Steps

1 program pattern consisting of 10 steps can be performed per channel.

Program Hold Function

Suspends the progression of the program control while the program control is running and performs the fixed value control with the set point (SP) at the time that the program control is held.

Advance Next Function

Terminates the current step while the program control is running and proceeds to the start of the next step.

Advance Previous Function

Moves back the progression of the program control while the program control is running.

Wait Function

When a step ends during program control, if the deviation between the process variable (PV) and set point (SP) is bigger than the wait value, the program control does not move to the next step. The program control proceeds to the next step once the deviation between the process variable (PV) and set point (SP) becomes smaller than the wait value.

Repeat Function

When the all steps are executed and the program control is terminated, the program control can be repeated from Step 0 as many times as the repeat number configured.

Program Control Operation Bits and Status Monitoring

By turning on/off the operation parameter bit, program control progression can be operated. By monitoring program run status, the current status of program control can be monitored. For the allocation of operation parameter, program run status, operating status, see pages 5-7 to 5-10.

Program Control Start (Start the program control)

Turn on the program control bit (Bit3) of the operation parameter. Program control starts.

Program Control Stop (Terminate the program control)

Turn off the program control bit (Bit3) of the operation parameter. Program control stops and enters standby status.

Program Hold (Suspend the program control)

Turn on the program hold bit (Bit4) of the operation parameter. Program control is held (Suspended). While the program control is held, time progression is suspended, and fixed value control is performed with the set point (SP) at the time that the program control is held. While program is held, the Program Control RUN/HOLD LED (R/H0 or R/H1) of the PID module flashes. To resume the program control, turn off the program hold bit (Bit4).

Advance Next Function (Proceed to the next step)

Turn off to on the advance next step (Bit6) of the operation parameter. The current step is terminated and the program control is proceeded to the start of the next step. The advance next function is also effective while the program control is in wait action.

Advance Previous Function (Move back the program control)

Turn off to on the advance previous step (Bit7) of the operation parameter. The progression of the current step is stopped and the program control is moved back. If the elapsed time in the current step is less than 1 minute, the program control goes back to the start of the previous step. If the elapsed time in the current step is longer than 1 minute, the program control goes back to the start of the current step. Even when the advance previous function is executed at Step 0, the program control does not move back to Step 9 regardless of the program end action.

Current Step Remaining Time

The remaining time of the current step is stored in the "Current Step Remaining Time" of Block 0. The remaining time is stored in seconds or minutes according to the "Step time unit" setting.

Current Step Number

The current step number (0 to 9) is stored in the "Current Step Number" of Block 0.

Program Wait (Perform program wait)

While the program wait is functioning, the program wait bit (Bit5) of the operating status is turned on. If the condition below is satisfied, the wait function is cancelled, the program control proceeds to the next step, and the program wait bit (Bit5) is turned off.

Set point (SP) - Wait value \leq Process variable (PV) \leq Set point (SP) + Wait value

If the advance next function (Bit6) is turned from off to on or if the program control bit (Bit3) is turned off, the wait function is canceled.

Program End Output (Program Termination)

When the program control is finished, the program end output bit (Bit6) of the operating status is turned on. If the program control bit (Bit3) of the operation parameter is turned off, the program end output bit (Bit6) is turned off. To start program control again, turn off to on the program control bit (Bit3) of the operation parameter.

Action when Program Control Starts

The program control mode start type can be selected from 3 types: PV start, PVR start, and SP start. When SP start is selected, the program control starts from the set point (SP) configured with “Set point (SP) when program control starts.” When PV start or PVR start is selected, and the program control starts, the step time is advanced until the set point (SP) matches to the process variable (PV), and then the program control starts. For details about the program control mode start type, see page 6-41.

In the following example, the set point (SP) is 100°C, the step time is 60 minutes, and the process variable (PV) when program control starts is 25°C.

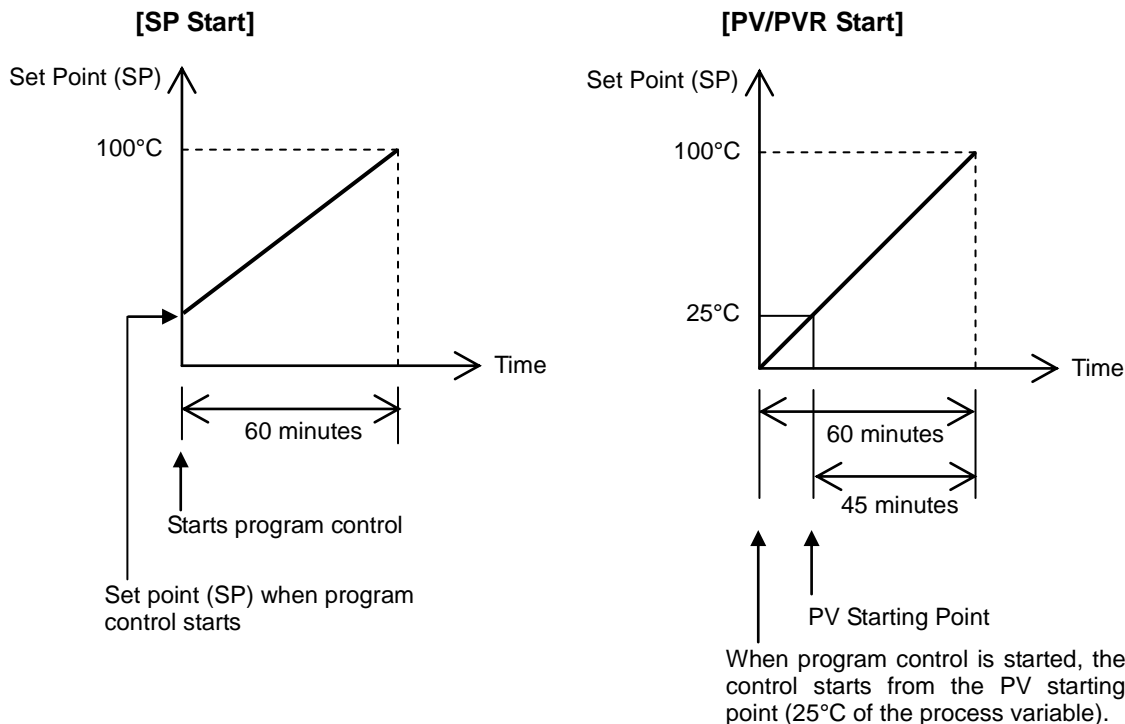

Program End Action

Program end action can be selected from 3 types: Terminate program control, Continue program control (Repeat), and Hold program control. When the all steps from 0 to 9 are executed and completed, the program control is finished. When “Terminate program control” is selected, the PID module will enter standby status after the program control is finished. While in standby status, no control is performed and the control output is in OFF status. If “Continue program control (Repeat)” is selected, the program control is repeated from step 0 as many times as the repeat number configured. When “Hold program control” is selected, the program control is held (suspended) after the program control is finished, and the fixed value control is performed with the set point (SP) of Step 9. For details about the program end action, see page 6-43.

Action after Power Is Restored

When the power is restored, every bit of the operation parameter excluding the program hold bit stored in the data register is maintained. If the power is failed and restored while the PID module performs the program control, the PID module starts its operation in accordance with the original PID module status before the power failure as shown in the table below.

Program End Action	PID Module Status before the Power Failure			
	Standby Status (*1)	Program Control is Performing.	Program Control is suspended (Hold)	Program Control is Terminated.
Terminate Program Control	Standby status is maintained.	The program control is continued. *2, *3	The program hold is canceled, and the program control is continued. *2, *3	The program control is started from the Step 0.
Continue Program Control (Repeat)				The program hold is maintained. Fixed value control is performed with the set point (SP) at the time that the power is turned off.
Hold Program Control				

- *1: The PID module is in standby status when the control enable bit is on but the program control bit is off. While in standby status, the PID module performs no control.
- *2: While the program control is running, the PID module saves the program control status every 6 minutes after the program control is started (after the program control bit is turned on). The program control status is also saved at the start of each step. If the power to the PID module is turned off while the program control is running, the PID module resumes the program control from the latest saved point.

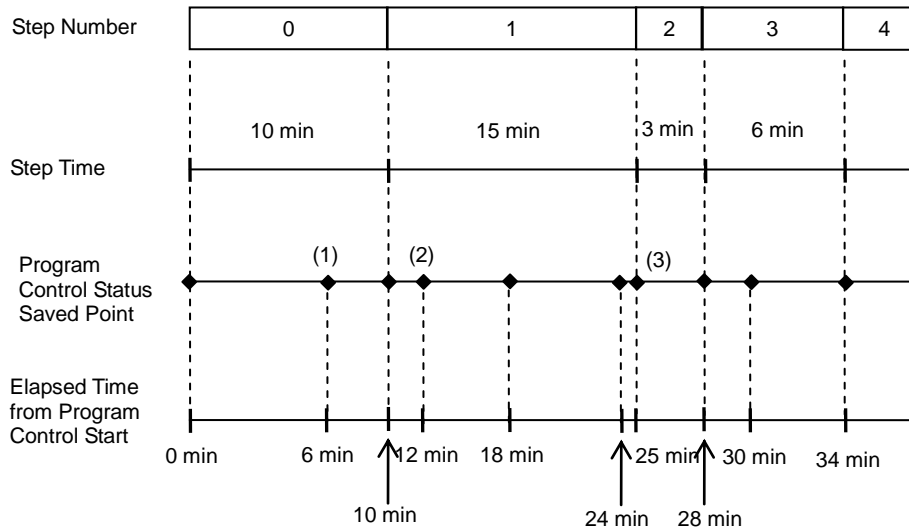

For example, if the power to the PID module is turned off in 7 minutes after the program control is started at step 0, the PID module resumes the program control at the status (1) when the power is restored. If the power to the PID module is turned off in 4 minutes after the program control enters step 1, the PID module resumes the program control at the status (2) when the power is restored. If the power to the PID module is turned off in 2 minutes after the program control enters step 2, the PID module resumes the program control at the status (3), which is the start of step 2, when the power is restored.

- *3: To restart the program control from the start of step 0, turn off and on the program control bit (operation parameter Bit3).

Program Pattern Example

The set point (SP) configured for each step is handled as the set point (SP) at the end of the step. The time configured for each step is the process time of each step.

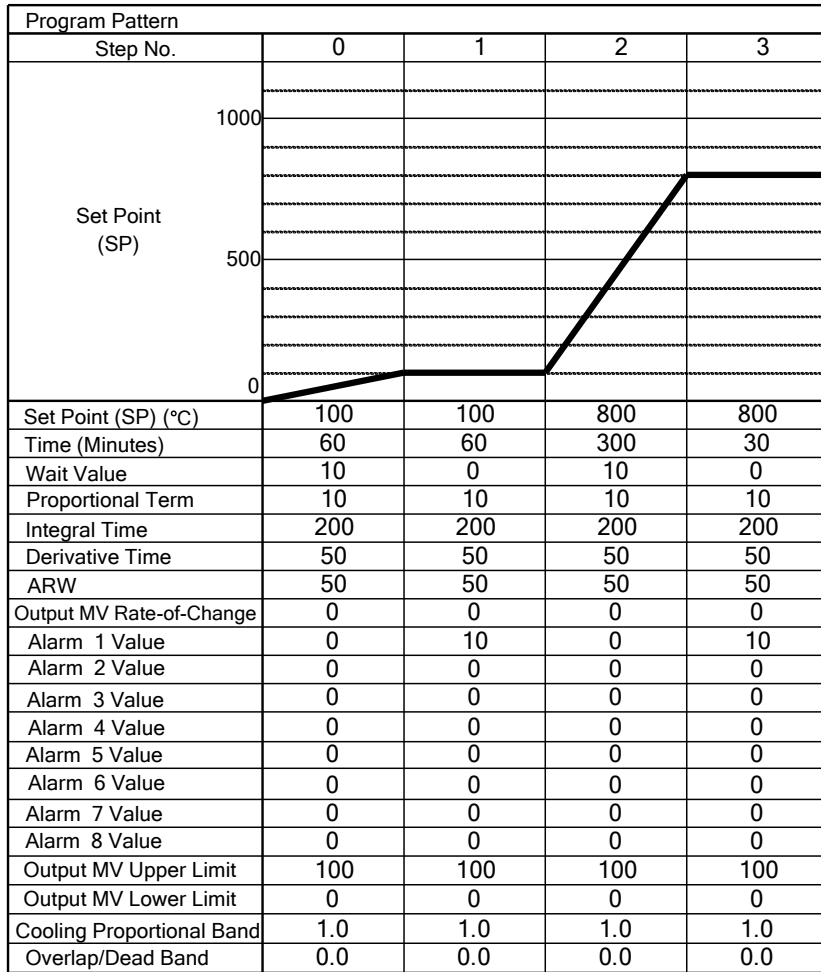

When the program pattern is configured as shown in the above table, the following control is performed at each step:

- [Step 0]: The set point (SP) is gradually risen to 100°C in 60 minutes.
When the step 0 ends, the wait function works so that the program control does not proceed to the step 1 until the process variable (PV) reaches 90°C.
- [Step 1]: The fixed value control is performed at 100°C of the set point (SP) for 60 minutes.
- [Step 2]: The set point (SP) is gradually risen to 800°C in 5 hours.
When the step ends, the wait function works so that the program control does not proceed to the step 3 until the process variable (PV) reaches 790°C.
- [Step 3]: The fixed value control is performed at 800°C of the set point (SP) for 30 minutes.

Heating/Cooling Control

When it is difficult to control the target process with heating control only, cooling control can be added to perform the heating/cooling control. Control results derived from the set point (SP) and process variable (PV) are outputted to 2 outputs, heating output (CH0) and cooling output (CH1). If the process variable (PV) is higher than the set point (SP), cooling output will be turned on. If the process variable (PV) is lower than the set point (SP), heating output will be turned on. The area in which both heating and cooling outputs are turned on can be configured as overlap. The area in which neither heating output nor cooling output is output can be configured as dead band.

Example: Heating/Cooling control uses both heating and cooling outputs and is suitable for the heat producing processes such as extruders or for temperature control at near ambient temperature such as environment testers.

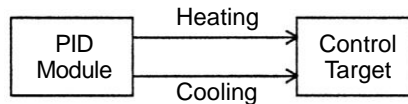

Difference Input Control

Difference input control is the control to keep the input difference between input CH0 and input CH1 at the same level. When the difference input control is selected, input CH0 and input CH1 are independently measured, and the difference between those inputs is used as process variable (PV). PID module controls output so that the difference between those inputs is matched to the set point (SP).

Example 1: Controlling the liquid level difference of 2 tanks

The PID module measures the liquid levels of 2 tanks and controls output to keep liquid level difference between Tank A and Tank B constant.

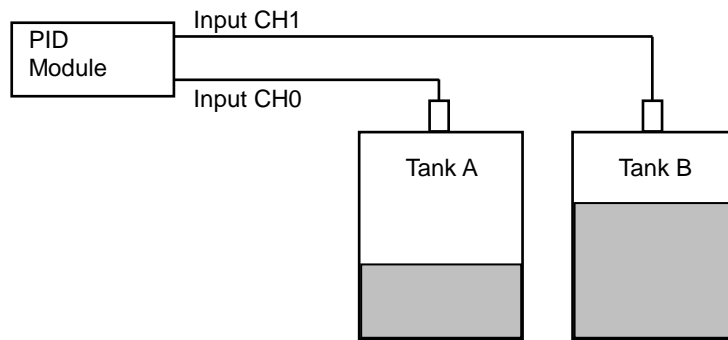

Example 2: Cabinet Interior Dew Condensation Prevention

The PID module measures interior and external temperatures of the cabinet and controls output to keep the temperature difference between interior and external cabinet constant so that dew condensation inside the cabinet can be prevented.

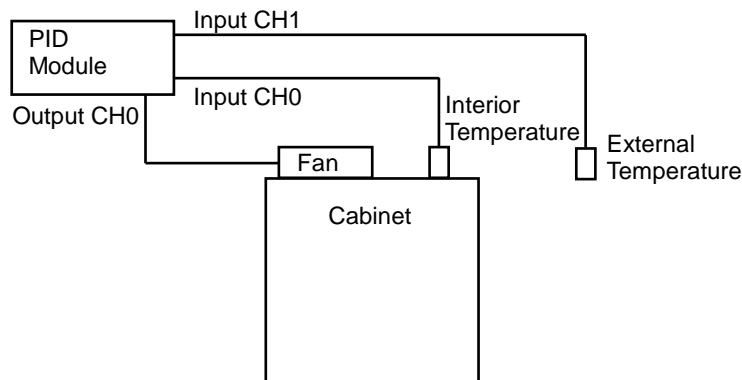

Cascade Control

The cascade control combines two PID controls to form one feedback loop to control a single target. The cascade control is effective for applications in which the delay time or dead time is considerably large. When delay time is large, it takes a long time for the process variable (PV) to change after the output manipulated variable (MV) is changed. By using the cascade control, highly stable control can be realized for such applications, though it takes time for the process variable (PV) to reach the set point (SP).

CH1 control is used as the master and CH0 control as the slave of the cascade control. The output manipulated variable (MV) of the master (CH1 control) becomes the set point (SP) of the slave (CH0 control), and the control result of CH0 is outputted from the CH0 output. The output manipulated variable (MV) (0 to 100%) of the master (CH1 control) is corresponded to the set point (SP) of the slave (CH0) according to the external SP input linear conversion minimum and maximum values. For example, when the external SP input linear conversion minimum value is 100°C and the maximum value is 400°C, the output manipulated variable (MV) (0 to 100%) of the master (CH1 control) is converted as follows: 0% is converted to 100°C, 50% is converted to 250°C, and 100% is converted to 400°C.

When a system using the cascade control is designed, it is required that the slave (CH0 control) have smaller delay time and faster response comparing to the master (CH1 control).

Example: The cascade control is used for an application in which the heat quantity of a heater is controlled using a power controller in order to control the temperature of the control target as shown in the figure below. It is also possible to utilize the heating/cooling control to prevent a rapid temperature rise of the control target by using a fan as the cooling output.

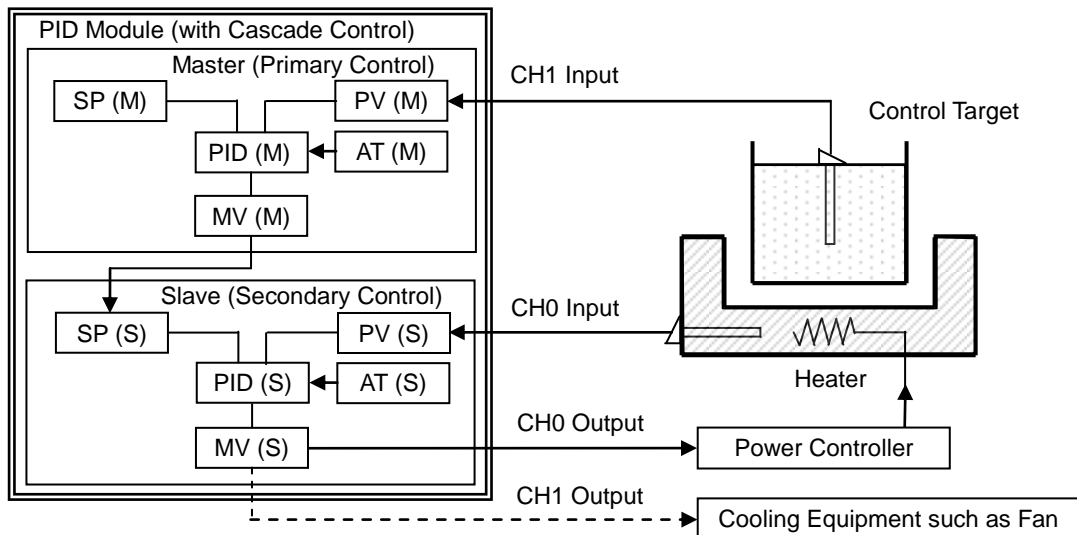

System Configuration and Wiring

Wiring Example of the FC5A-F2M2 [Current Output Type]

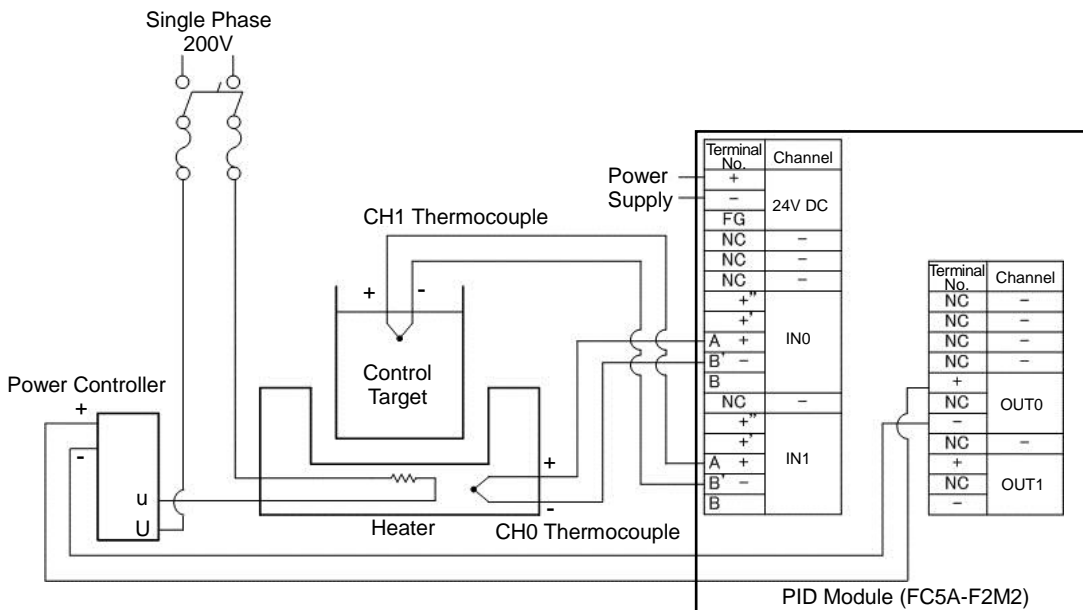

How to perform auto-tuning (AT) in cascade control

Auto-tuning (AT) can be performed for the cascade control with the following procedure.

Auto-tuning (AT) for the slave (CH0)

1. Turn off the CH0 and CH1 control enable bits of the operation parameter to disable the CH0 and CH1 controls.
2. Copy the set point (SP) of the master (CH1) to the set point (SP) of the slave (CH0), the external SP input linear conversion maximum value, and the external SP input linear conversion minimum value in order to fix the set point (SP) of the slave (CH0).
3. Turn on the CH0 and CH1 control enable bits of the operation parameter to enable the CH0 and CH1 controls. Turn on the CH0 auto-tuning (AT)/auto-reset bit of the operation parameter to start the auto-tuning (AT) for the slave (CH0).
When auto-tuning (AT) is completed, P, I, D and ARW values of the slave (CH0) will be automatically configured.

Auto-tuning (AT) for the master (CH1)

4. Turn off the CH1 control enable bit of the operation parameter to disable the CH1 control.
5. Store the original values in the external SP input linear conversion maximum and minimum values.
6. Turn on the CH1 control enable bit and CH1 auto-tuning (AT)/auto-reset bit of the operation parameter to enable the CH1 control and start the auto-tuning (AT) for the master (CH1).
When auto-tuning (AT) is completed, P, I, D and ARW values of the master (CH1) will be automatically configured.

Notes:

- When using the cascade control, store the same set point of the master (CH1) to the set point (SP) of the slave (CH0).
- The output manipulated variable (MV) (0 to 100%) of the master (CH1) corresponds to the set point (SP) of the slave (CH0). The range of the set point is the external SP input linear conversion minimum value to the external SP input linear conversion maximum value.
- Depending on each control target, optimum values of P, I, D and ARW may not be calculated with the auto-tuning (AT). In such case, configure those parameters manually based on the P, I, D and ARW values calculated with the auto-tuning (AT).

Program Example of Auto-tuning (AT) for Cascade Control

A sample ladder program to execute the auto-tuning (AT) for the master (CH1) and slave (CH0) in the cascade control is described in the following page.

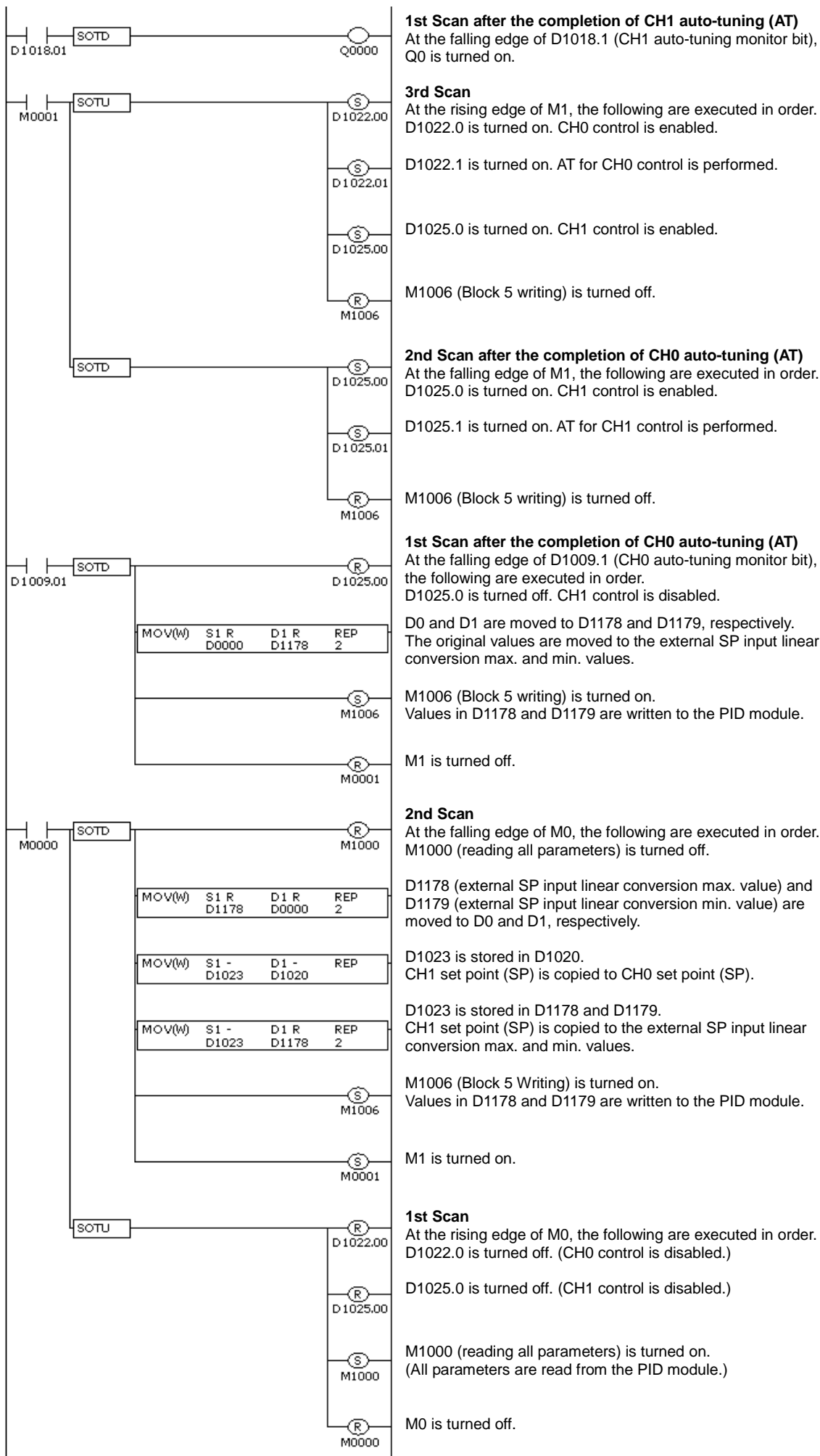

External PV Mode

External PV mode is a mode where control target temperature PV1 (process variable with decimal point) read by the PID module is used for a calculation in the ladder program of the CPU module, and PID control is performed based on that calculated result. External PV mode can only be used when the PID module system program version is 102 or higher and WindLDR version is 7.22 or higher. For how to confirm the PID module system program version, see Chapter 1 "Confirming the PID Module System Program Version" (page 1-3).

When external PV mode is disabled

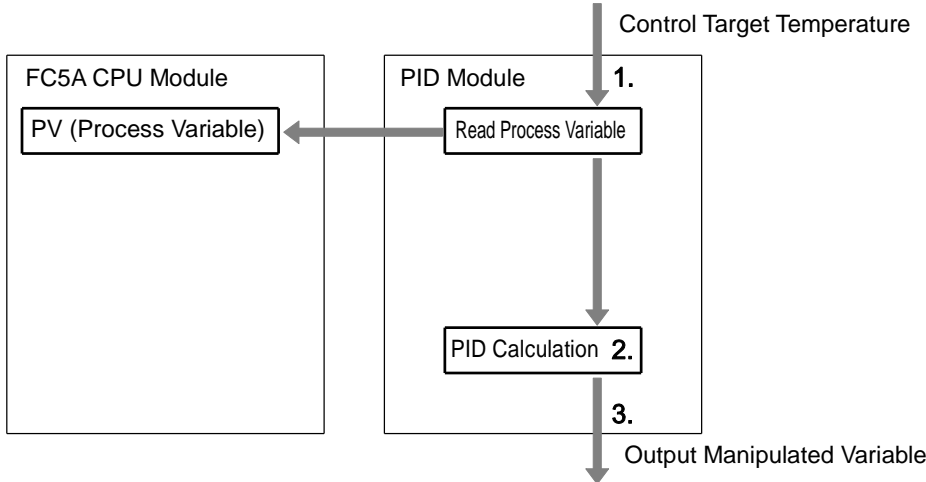

1. The PID module reads the control target temperature as the process variable.
2. The PID module performs the PID calculation using the process variable.
3. The PID module outputs the manipulated variable.

When external PV mode is enabled

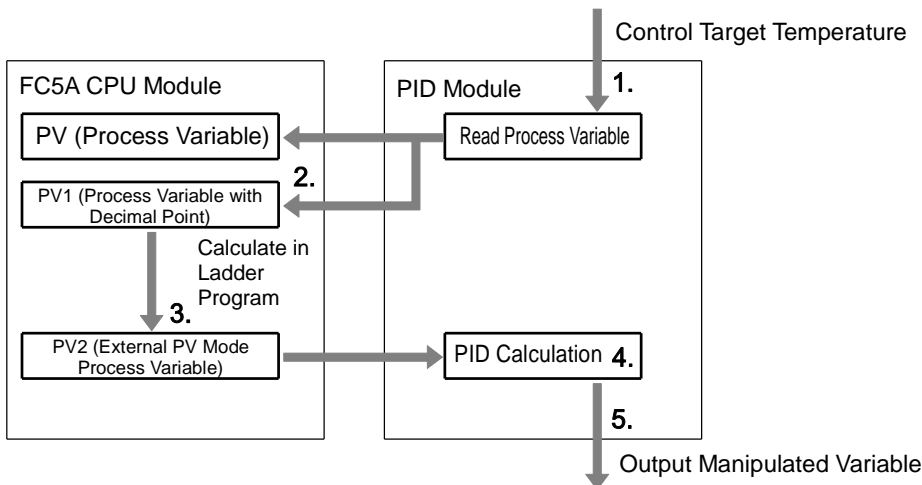

1. The PID module reads the control target temperature as the process variable.
2. The CPU module reads PV1 (process variable with decimal point) from the PID module.
3. The CPU module performs a calculation using PV1 (process variable with decimal point) in the ladder program and calculates PV2 (external PV mode process variable).
4. The PID module reads PV2 (external PV mode process variable) from the CPU module and performs the PID calculation.
5. The PID module outputs the manipulated variable.

Notes:

- The process variable read from the control target is retained as PV (process variable without decimal point) and PV1 (process variable with decimal point).
- When external PV mode is enabled, use PV1 (process variable with decimal point) to obtain PV2 (external PV mode process variable). By using the process variable with decimal point, high-precision PID control can be performed.

5: DEVICE ALLOCATION OF PID MODULE

This chapter describes the valid devices, control registers, control relays, and data register allocation for the PID module.

Device Allocation of PID Module

The PID module is used by connecting to the MicroSmart CPU module. To use the PID module, allocate the data register and internal relay to the PID module, configure the initial parameters using WindLDR, and download the user program and the parameters to the CPU module and the PID module. The initial parameters are downloaded to the CPU module along with the user program. The CPU module reads/writes data from/to the PID module according to the parameters configured in WindLDR.

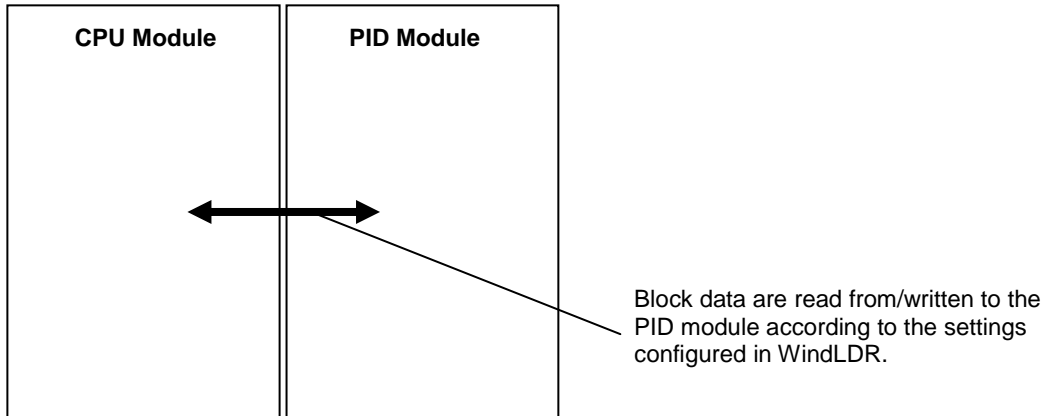

The PID module parameters consist of 26 data blocks divided according to the function and frequency of use of each parameter as shown in the table below. All blocks to be used are allocated to the data registers in the CPU module. The parameters of each block can be read from/written to the PID module using the allocated control relays.

Block	Number of Data Registers	Description
Block 0	20	Read only parameters (CH0, CH1)
Block 1	6	Write only parameters (CH0, CH1)
Block 2	27	Basic parameters (CH0)
Block 3	27	Basic parameters (CH1)
Block 4	50	Initial setting parameters (CH0)
Block 5	50	Initial setting parameters (CH1)
Blocks 10 to 19	21/block	Program parameters (CH0)
Blocks 30 to 39	19/block	Program parameters (CH1)

Block 0 includes parameters such as operating status, current process variable (PV), set point (SP), and output manipulated variable (MV) of the PID module. The CPU module reads those parameters from the PID module every scan. The control status and alarm status of the PID module can be monitored with Block 0 parameters.

Block 1 includes the set point (SP), manual mode output manipulated variable (MV), and operation parameters of the PID module. Those parameters are written to the PID module every scan. Operations such as changing the set point (SP) for the fixed value control, enabling/disabling the control, or performing auto-tuning (AT) can be carried out.

Blocks 2 and 3 include basic parameters of the PID module. By turning the control relay from off to on, parameters can be read from/ written to the PID module.

Blocks 4 and 5 include initial setting parameters of the PID module. Parameters that are usually not changed during the operation are stored.

Blocks 10 to 19 and 30 to 39 include parameters of each step of the program control. By turning the control relay from off to on, parameters can be read from/written to the PID module.

Program Size

The user program size that the PID module uses depends on CPU module type. The table below shows the program size required to use a PID module.

	Program Size	
	Both CH0 and CH1 are in fixed value control mode	CH0 or CH1 is in program control mode
All-in-one Type	1,300 bytes	4,400 bytes
Slim Type	1,200 bytes	3,900 bytes

Valid Devices

The following devices can be allocated as the control register and relay for the PID module. Control register and relay should be configured for each PID module. Duplicated device cannot be configured.

	I	Q	M	R	T	C	D	Constant
Control Register	-	-	-	-	-	-	X	-
Control Relay	-	-	X	-	-	-	-	-

Control Register

The PID module occupies a maximum of 590 data registers (minimum 190 data registers) per PID module. The occupied number of data registers varies between the fixed value control mode and program control mode. When both CH0 and CH1 are in fixed value control mode, 190 data registers are occupied, including the first data register designated. When either CH0 or CH1 is in program control mode, 590 data registers are occupied, including the first data register designated.

Precautions when Connecting Four PID Modules to All-in-One Type CPU Module

2000 data registers (D0 to D1999) are allocated to the all-in-one type CPU module. When four PID modules are connected to the all-in-one type CPU module, a maximum of six program controls can be conducted with three PID modules among the four PID modules.

The configurations shown in the examples 1 and 2 are not possible because the total number of occupied data registers exceeds 2000.

Example 1: Program control mode is selected in all four PID modules

Module Type	Type No.	Control Mode		Occupied Data Register (Word)
		CH0	CH1	
PID Module	FC5A-F2MR2/FC5A-F2M2	Program control mode	Program control mode	590
	FC5A-F2MR2/FC5A-F2M2	Program control mode	Program control mode	590
	FC5A-F2MR2/FC5A-F2M2	Program control mode	Program control mode	590
	FC5A-F2MR2/FC5A-F2M2	Fixed value control mode	Program control mode	590
Total				2360

Example 2: Program control mode is selected in all four PID modules

Module Type	Type No.	Control Mode		Occupied Data Register (Word)
		CH0	CH1	
PID Module	FC5A-F2MR2/FC5A-F2M2	Fixed value control mode	Program control mode	590
	FC5A-F2MR2/FC5A-F2M2	Fixed value control mode	Program control mode	590
	FC5A-F2MR2/FC5A-F2M2	Program control mode	Fixed value control mode	590
	FC5A-F2MR2/FC5A-F2M2	Program control mode	Fixed value control mode	590
Total				2360

The configurations shown in the example 3 and 4 are possible because the total number of occupied data registers is less than 2000.

Example 3: Program control mode is selected in three PID modules

Module Type	Type No.	Control Mode		Occupied Data Register (Word)
		CH0	CH1	
PID Module	FC5A-F2MR2/FC5A-F2M2	Program control mode	Program control mode	590
	FC5A-F2MR2/FC5A-F2M2	Fixed value control mode	Program control mode	590
	FC5A-F2MR2/FC5A-F2M2	Program control mode	Program control mode	590
	FC5A-F2MR2/FC5A-F2M2	Fixed value control mode	Fixed value control mode	190
Total				1960

Example 4: Program control mode is selected in two PID modules

Module Type	Type No.	Control Mode		Occupied Data Register (Word)
		CH0	CH1	
PID Module	FC5A-F2MR2/FC5A-F2M2	Program control mode	Fixed value control mode	590
	FC5A-F2MR2/FC5A-F2M2	Program control mode	Program control mode	590
	FC5A-F2MR2/FC5A-F2M2	Fixed value control mode	Fixed value control mode	190
	FC5A-F2MR2/FC5A-F2M2	Fixed value control mode	Fixed value control mode	190
Total				1560

Control Relay

The PID module occupies a maximum of 32 internal relays (minimum 8 internal relays) per module. The occupied number of internal relays varies between the fixed value control mode and program control mode. When both CH0 and CH1 are in fixed value control mode, 8 internal relays are occupied. When either CH0 or CH1 is in program control mode, 32 internal relays are occupied.

Internal Relay Allocation

When both CH0 and CH1 are in fixed value control mode, the following 8 internal relays are allocated:

Offset from the Control Relay	Description	R/W
+0	Reading all parameters (PID module → CPU module data registers)	R/W
+1	Loading initial values (CPU module ROM → data registers)	R/W
+2	Writing all parameters (CPU module data registers → PID module)	R/W
+3	Block 2 (CH0 basic parameters) writing	R/W
+4	Block 3 (CH1 basic parameters) writing	R/W
+5	Block 4 (CH0 initial setting parameters) writing	R/W
+6	Block 5 (CH1 initial setting parameters) writing	R/W
+7	Reserved	R/W

When either CH0 or CH1 is in program control mode, the following 32 internal relays are allocated:

Offset from the Control Relay	Description	R/W
+0	Reading all parameters (PID module → CPU module data register)	R/W
+1	Loading initial values (CPU module ROM → Data register)	R/W
+2	Writing all parameters (CPU module data register → PID module)	R/W
+3	Block 2 (CH0 basic parameters) writing	R/W
+4	Block 3 (CH1 basic parameters) writing	R/W
+5	Block 4 (CH0 initial setting parameters) writing	R/W
+6	Block 5 (CH1 initial setting parameters) writing	R/W
+7	Reserved	R/W
+8	Block 10 (CH0 Step 0) writing	R/W
+9	Block 11 (CH0 Step 1) writing	R/W
+10	Block 12 (CH0 Step 2) writing	R/W
+11	Block 13 (CH0 Step 3) writing	R/W
+12	Block 14 (CH0 Step 4) writing	R/W
+13	Block 15 (CH0 Step 5) writing	R/W
+14	Block 16 (CH0 Step 6) writing	R/W
+15	Block 17 (CH0 Step 7) writing	R/W
+16	Block 18 (CH0 Step 8) writing	R/W
+17	Block 19 (CH0 Step 9) writing	R/W
+18	Block 30 (CH1 Step 0) writing	R/W
+19	Block 31 (CH1 Step 1) writing	R/W
+20	Block 32 (CH1 Step 2) writing	R/W
+21	Block 33 (CH1 Step 3) writing	R/W
+22	Block 34 (CH1 Step 4) writing	R/W
+23	Block 35 (CH1 Step 5) writing	R/W
+24	Block 36 (CH1 Step 6) writing	R/W
+25	Block 37 (CH1 Step 7) writing	R/W
+26	Block 38 (CH1 Step 8) writing	R/W

+27	Block 39 (CH1 Step 9) writing	R/W
+28	Reserved	R/W
+29	Reserved	R/W
+30	Reserved	R/W
+31	Reserved	R/W

For details about blocks, see page 5-7 to 5-24.

Notes about the control relays:

- The control relay +0: Reading all parameters
When this bit is turned off to on, all parameters stored in the ROM of the PID module are read out and stored in the data registers in the CPU module.
- The control relay +1: Loading initial values
When the user program is downloaded to the CPU module, the initial values of all parameters for the PID module are also downloaded and stored in the ROM of the CPU module. When this bit is turned off to on, the initial values stored in the ROM are loaded into the data registers (RAM).
- The control relay +2: Writing all parameters
When this bit is turned off to on, all parameters stored in the data registers are written to the ROM of the PID module.
- The control relay +3 through +27: Writing blocks 2 to 5, 10 to 19, and 30 to 39
When the writing bit is turned off to on, the corresponding block parameters stored in the data registers are written to the ROM of the PID module.

Data Flow of the PID module parameters

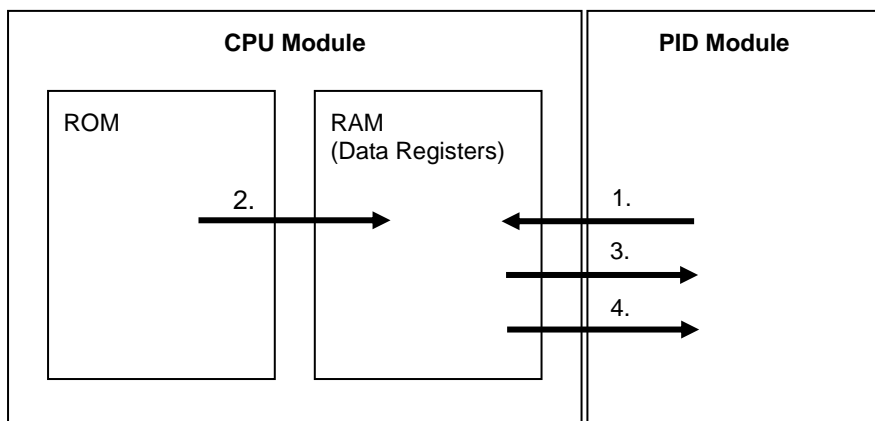

1. All parameters are read out from the PID module and stored in the data registers in the CPU module when the reading all parameters bit is turned off to on.
2. Initial values stored in the ROM of the CPU module are loaded to the data registers when the loading initial values bit is turned off to on.
3. All parameters stored in the data registers are written to the PID module when the writing all parameters bit is turned off to on.
4. The block parameters stored in the data registers are written to the PID module when the block writing bit is turned off to on.

Note:

The communication status between the CPU module and the PID module can be confirmed with the following data register.

- When both CH0 and CH1 are in fixed value control mode: First data register + 189
- When CH0 or CH1 is in program control mode: First data register + 589

Data Register Value	Description	
0	Normal operation	
1	Bus error	Turn off the MicroSmart and connect the PID module again.
3	Invalid module number	The PID module is not connected to the configured slot number. Turn off the MicroSmart and connect the PID module to the appropriate slot number.

Examples of changing the PID module parameters using the control relay

All parameters of block 1 to 5, 10 to 19, and 30 to 39 can be changed using a ladder program. The following examples demonstrate how the parameters of the PID module can be changed. See pages 5-7 to 5-24 for detail about each block parameter.

Example 1: Changing Block 1 Parameter

The set point (SP) of CH0 control (D1020) is changed to 250.5°C. In this example, D1000 is allocated to the control register and M500 is allocated to control relay.

When the new set point 2505 is stored in D1020 ^{*1}, it is automatically written to the PID module ^{*2}.

Ladder Program Example:

When external input I0 is turned on, the set point (SP) of CH0 will be changed to 250.5°C.

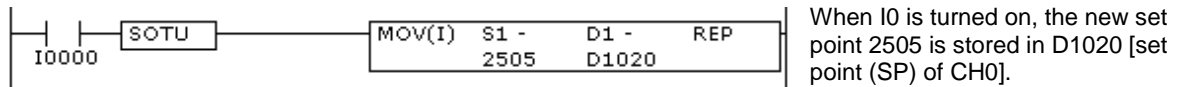

*1: When the input range has a decimal point, store the value multiplied by 10 in the data register.

*2: When the control register is D1000, Block 1 parameters are stored in D1020 to D1025. These values are written to the PID module every scan.

Example 2: Changing Block 2 Parameters

The integral time (D1027) is changed to 150 seconds and the derivative time (D1028) is changed to 45 seconds for CH0 control. In this example, D1000 is allocated to the control register and M500 is allocated to control relay.

Those parameters can be changed with the following procedure.

1. Turn on M500 (Reading all parameters). All PID module parameters are read out from the PID module and stored in the data registers. ^{*1}
2. Store 150 in D1027 (integral time of CH0) and 45 in D1028 (derivative time of CH0).
3. Turn on M503 (Block 2 writing) ^{*2}. The integral time (150 sec) and derivative time (45 sec) will be written to the PID module.

Ladder Program Example:

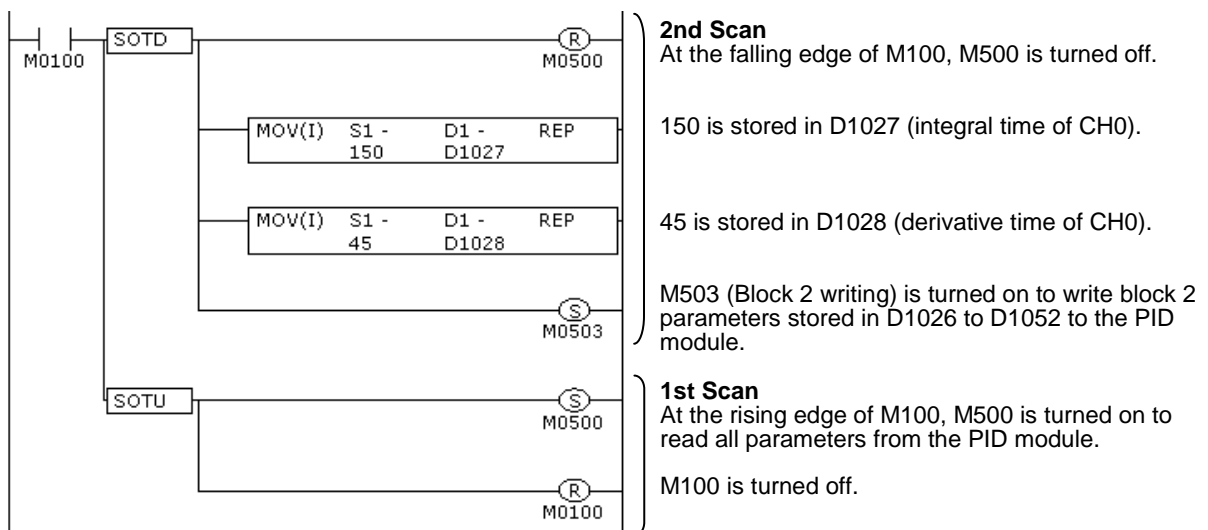

*1: If the reading all parameters bit (M500) is turned on, all PID module parameters are read out from the PID module and stored in the data registers. Block 2 parameters are stored in D1026 to D1052.

*2: Block 2 parameters stored in D1026 to D1052 are written to the PID module. The parameters of the other blocks are not written.

Example 3: Changing Block 4 Parameter

The PV filter time constant (D1063) of CH0 is changed to 1.5 seconds. In this example, D1000 is allocated to the control register and M500 is allocated to control relay.

The parameter can be changed with the following procedure.

1. Turn on M500 (Reading all parameters). All PID module parameters are read out from the PID module and stored in the data registers of the CPU module.^{*1}
2. Turn off D1022.0 (Control enable bit of CH0). CH0 control of the PID module will be disabled.
3. Store 15 in D1063 (PV filter time constant of CH0).^{*2}
4. Turn on M505 (Block 4 writing).^{*3}
5. Turn on D1022.0 (Control enable bit of CH0). CH0 of the PID module will be enabled.

Ladder Program Example:

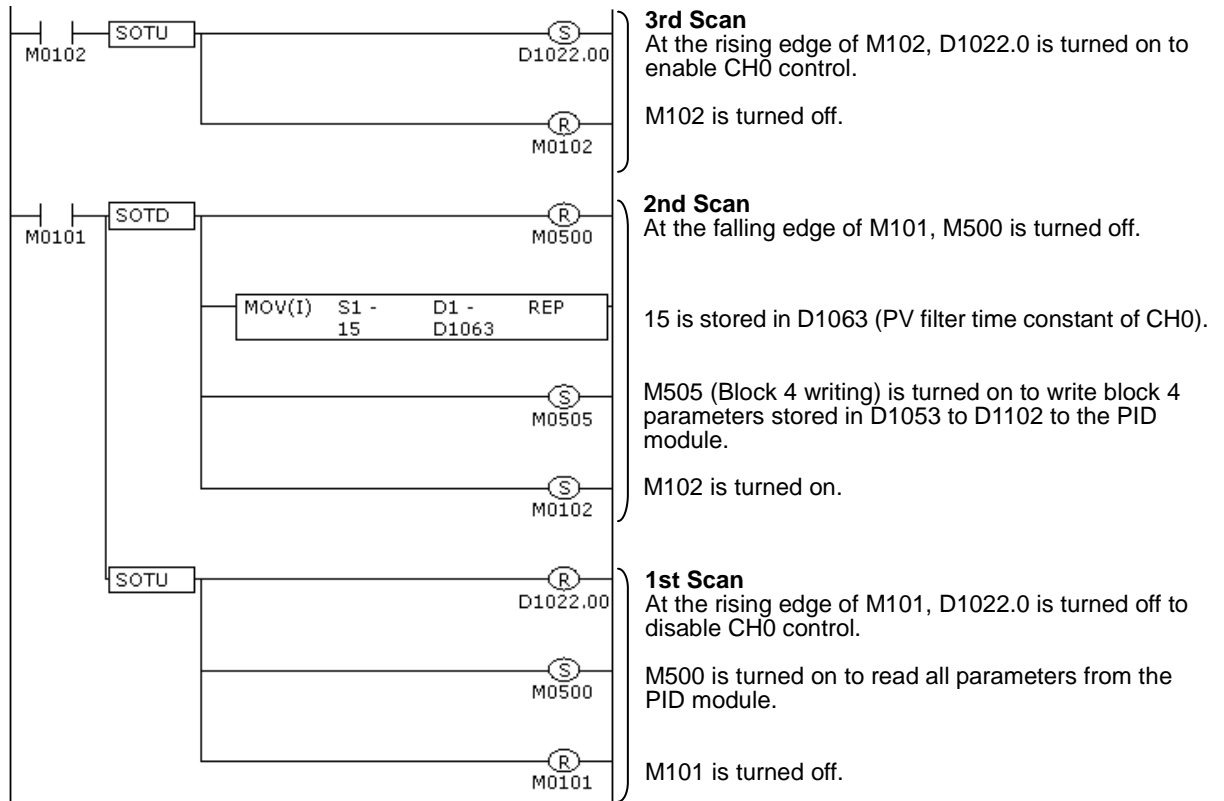

*1: If the reading all parameters (M500) is turned on, all PID module parameters are read out from the PID module and stored in the data registers. Block 4 parameters are stored in D1053 to D1102.

*2: For a value with a decimal point, store the value multiplied by 10 in the data register.

*3: Block 4 parameters stored in D1053 to D1102 are written to the PID module. The parameters of the other blocks are not written.

Note: If parameters of block 4 or 5 are changed while CH0 or CH1 control is enabled in the PID module, an unexpected operation of the PID module may be caused. It is recommended that the control channel of the PID module be disabled before changing the parameters of block 4 or 5.

Data Register Allocation - Block 0 Read Only Parameters

The CPU module reads the following parameters from the PID module and store them in the data registers every scan.

Offset from the Control Register		Parameter	Description	R/W
0	Common	PID Module Operating Status	0000h: Initialization 0001h: Normal operation 0002h: External power supply error	R
+1	CH0	Current Process Variable (PV)	When input is normal: Value within the control range (see 9-4) When input is invalid: Unknown value	R
+2		Current Heating Output Manipulated Variable (MV)	Output manipulated variable lower limit to upper limit	R
+3		Current Cooling Output Manipulated Variable (MV)	Cooling output manipulated variable lower limit to upper limit	R
+4		Current Set Point (SP)	When input is thermocouple or resistance thermometer: Set point (SP) lower limit to set point (SP) upper limit When input is voltage or current input: Linear conversion min. to linear conversion max.	R
+5		Current Step Remaining Time	0 to 6000 minutes/seconds	R
+6		Current Step Number	0 to 9	R
+7		Remaining Repeat Number	0 to 10000	R
+8		When external PV mode is disabled: Reserved	—	R
		When external PV mode is enabled: Current process variable with decimal point (PV1)	When input is normal: Value within the Input range (see 5-22) When input is invalid: Unknown value	
+9		Operation Parameter Monitor	See 5-8 for detail about the operation parameter monitor.	R
+10	Operating Status	See 5-9 for detail about the operating status.	R	
+11	CH1	Current Process Variable (PV)	When input is normal: Value within the control range (see 9-4) When input is invalid: Unknown value	R
+12		Current Output Manipulated Variable (MV)	Output manipulated variable lower limit to upper limit	R
+13		Current Set Point (SP)	When input is thermocouple or resistance thermometer: Set point (SP) lower limit to set point (SP) upper limit When input is voltage or current input: Linear conversion min. to linear conversion max.	R
+14		Current Step Remaining Time	0 to 6000 minutes/seconds	R
+15		Current Step Number	0 to 9	R
+16		Remaining Repeat Number	0 to 10000	R
+17		When external PV mode is disabled: Reserved	—	R
		When external PV mode is enabled: Read current process variable with decimal point (PV1)	When input is normal: Value within the Input range (see 5-22) When input is invalid: Unknown value	
+18		Operation Parameter Monitor	See 5-8 for detail about the operation parameter monitor.	R
+19		Operating Status	See 5-9 for detail about the operating status.	R

Operation Parameter Monitor

Bit	Operation Parameter Monitor (1 word)		
	Parameter	Status	Description
Bit0	Control Enable Bit	0	Control is disabled
		1	Control is enabled
Bit1	Auto-tuning (AT)/Auto-Reset Bit	0	Normal operation
		1	Auto-tuning (AT)/Auto-reset is being performed
Bit2	Auto/Manual Mode Bit	0	Auto mode
		1	Manual mode
Bit3	Program Control Bit	0	Program control is stopped
		1	Program control is running
Bit4	Program Hold Bit	0	Normal operation
		1	Program control is held
Bit5	External SP Input Enable Bit (CH0 only)	0	External SP input is disabled
		1	External SP input is enabled
Bit6	Parameter Range Error Bit (Note)	0	All parameters are within the valid range
		1	All parameters are out of the valid range
Bit7	Set point (SP) Range Error Bit	0	Set point (SP) is within the valid range.
		1	Set point (SP) is within the valid range.
Bit8	Manual Mode Output Manipulated Variable Range Error Bit	0	Manual mode output manipulated variable is within the valid range.
		1	Manual mode output manipulated variable is out of the valid range.
Bit9	Proportional Band/Integral Time/Derivative Time/ARW/Control Period Range Error Bit	0	Proportional band, integral Time, derivative time, ARW, or control period is within the valid range.
		1	Proportional band, integral Time, derivative time, ARW, or control period is out of the valid range.
Bit10	Reset Setting Range Error Bit	0	Reset setting is within the valid range.
		1	Reset setting is out of the valid range.
Bit11	Cooling Proportional Band/Cooling Control Period Range Error Bit (CH0 only)	0	Cooling proportional band or cooling control period is within the valid range.
		1	Cooling proportional band or cooling control period is out of the valid range.
Bit12	Overlap/Dead Band Range Error Bit (CH0 only)	0	Overlap/dead band is within the valid range.
		1	Overlap/dead band is out of the valid range.
Bit13	Alarm 1 to Alarm 8 Value Range Error Bit	0	Alarm 1 to Alarm 8 values are within the valid range.
		1	Alarm 1 to Alarm 8 values are out of the valid range.
Bit14	PV Filter/PV Correction Range Error Bit	0	PV Filter/PV Correction is within the valid range.
		1	PV Filter/PV Correction is out of the valid range.
Bit15	Program Control Set Point (SP) Range Error Bit	0	Program control set point (SP) is within the valid range.
		1	Program control set point (SP) is out of the valid range.

Note: The parameter range error bit is turned on when any parameter of the PID module is out of the valid range. While the parameter range error is occurring, the control output is turned off.

Operating Status

Bit	Operating Status (1 word)		
	Parameter	Status	Description
Bit0	(Heating) Control Output	0	OFF
		1	ON (Unknown for current output)
Bit1	Cooling Control Output (CHO only)	0	OFF
		1	ON (Unknown for current output)
Bit2	Loop Break Alarm	0	Normal operation
		1	Loop break alarm is occurring
Bit3	Over Range	0	Normal operation
		1	Input value is exceeding the upper limit of the control range (See page 9-4). Thermocouple or resistance thermometer may be burnt out. Voltage input (0 to 1V DC) may be disconnected.
Bit4	Under Range	0	Normal operation
		1	Input value is below the lower limit of the control range (See page 9-4). Voltage input (0 to 5V DC) may be disconnected. Current input (4 to 20mA DC) may be disconnected.
Bit5	Program Wait	0	Normal operation
		1	Program wait is functioning
Bit6	Program End Output	0	OFF
		1	ON
Bit7	Alarm 1 Output	0	OFF
		1	ON
Bit8	Alarm 2 Output	0	OFF
		1	ON
Bit9	Alarm 3 Output	0	OFF
		1	ON
Bit10	Alarm 4 Output	0	OFF
		1	ON
Bit11	Alarm 5 Output	0	OFF
		1	ON
Bit12	Alarm 6 Output	0	OFF
		1	ON
Bit13	Alarm 7 Output	0	OFF
		1	ON
Bit14	Alarm 8 Output	0	OFF
		1	ON
Bit15	Reserved	0	0 (Fixed value)

Data Register Allocation - Block 1 Write Only Parameters

The CPU module writes the following parameters stored in the data registers to the PID module every scan.

Offset from the Control Register	Parameter		Description	R/W
+20		Set Point (SP)	When the input is thermocouple or resistance thermometer: Set point (SP) lower limit to set point (SP) upper limit When the input is voltage or current input: Linear conversion min. to linear conversion max.	W
+21	CH0	When external PV mode is disabled: Manual Mode Output Manipulated Variable	When heating/cooling control is disabled: Output manipulated variable lower limit to output manipulated variable upper limit When heating/cooling control is enabled: - Cooling output manipulated variable upper limit to heating output manipulated variable upper limit	W
		When external PV mode is enabled: External PV Mode Process Variable (PV2)	Value within the Input range (see 5-22)	
+22		Operation Parameter	Refer to the table below for the operation parameters	W
+23		Set Point (SP)	When the input is thermocouple or resistance thermometer: Set point (SP) lower limit to set point (SP) upper limit When the input is voltage or current input: Linear conversion min. to linear conversion max.	W
+24	CH1	When external PV mode is disabled: Manual Mode Output Manipulated Variable	When heating/cooling control is disabled: Output manipulated variable lower limit to output manipulated variable upper limit When heating/cooling control is enabled: - Cooling output manipulated variable upper limit to heating output manipulated variable upper limit	W
		When external PV mode is enabled: External PV Mode Process Variable (PV2)	Value within the Input range (see 5-22)	
+25		Operation Parameter	Refer to the table below for the operation parameters	W

Note: When the power to the PID module is turned off, Block 1 parameters are cleared to zero.

Operation Parameters

Bit	Operation Parameters (1 word)		
	Item	Status	Description
Bit0	Control Enable Bit	0	Control disable
		1	Control enable
Bit1	Auto-tuning (AT)/Auto-Reset Bit *1	0	Auto-tuning (AT)/Auto-reset cancel
		1	Auto-tuning (AT)/Auto-reset perform
Bit2	Auto/Manual Mode Bit	0	Auto mode
		1	Manual mode
Bit3	Program Control Bit	0	Program control stop
		1	Program control run
Bit4	Program Hold Bit *2	0	Program control run
		1	Program control hold
Bit5	External SP Input Enable Bit	0	External SP input disable
		1	External SP input enable
Bit6	Advance Next Step Bit *3	0	No action
		1	Program control advance next step
Bit7	Advance Previous Step Bit *4	0	No action
		1	Program control advance previous step
Bit8	External PV Mode Enable Bit *5	0	External PV mode disabled
		1	External PV mode enabled
Bit9 to Bit15	Reserved	0	Fixed value 0

- *1: Once auto-reset is performed, it cannot be cancelled during its performance.
- *2: The program control is suspended while the program hold bit is on.
- *3: During the program control, the current step is terminated and the program control is proceeded to the start of the next step when the advance next step bit is turned off to on.
- *4: During the program control, the progression of the program control is moved back when the advance previous step bit is turned off to on. If the elapsed time in the current step is less than 1 minute, the program control goes back to the start of the previous step. If the elapsed time in the current step is more than or equal to 1 minute, the program control goes back to the start of the current step. Even when the advance previous step is executed at Step 0, the program control does not move back to Step 9 regardless of the program end action.
- *5: External PV mode is only executed in auto mode. External PV mode is not executed in manual mode, even if enabled.

Examples of Program Control Progress

Example 1: Terminate Program Control when Program Ends

The following diagram shows an example of the program control when terminate program control is selected as the program end action.

Time of steps: Step 0 and 1: 60 minutes, Step 2: 30 minutes, Steps 3 to 9: 0 minute

In this example, D1000 is allocated to the control register and M500 is allocated to control relay.

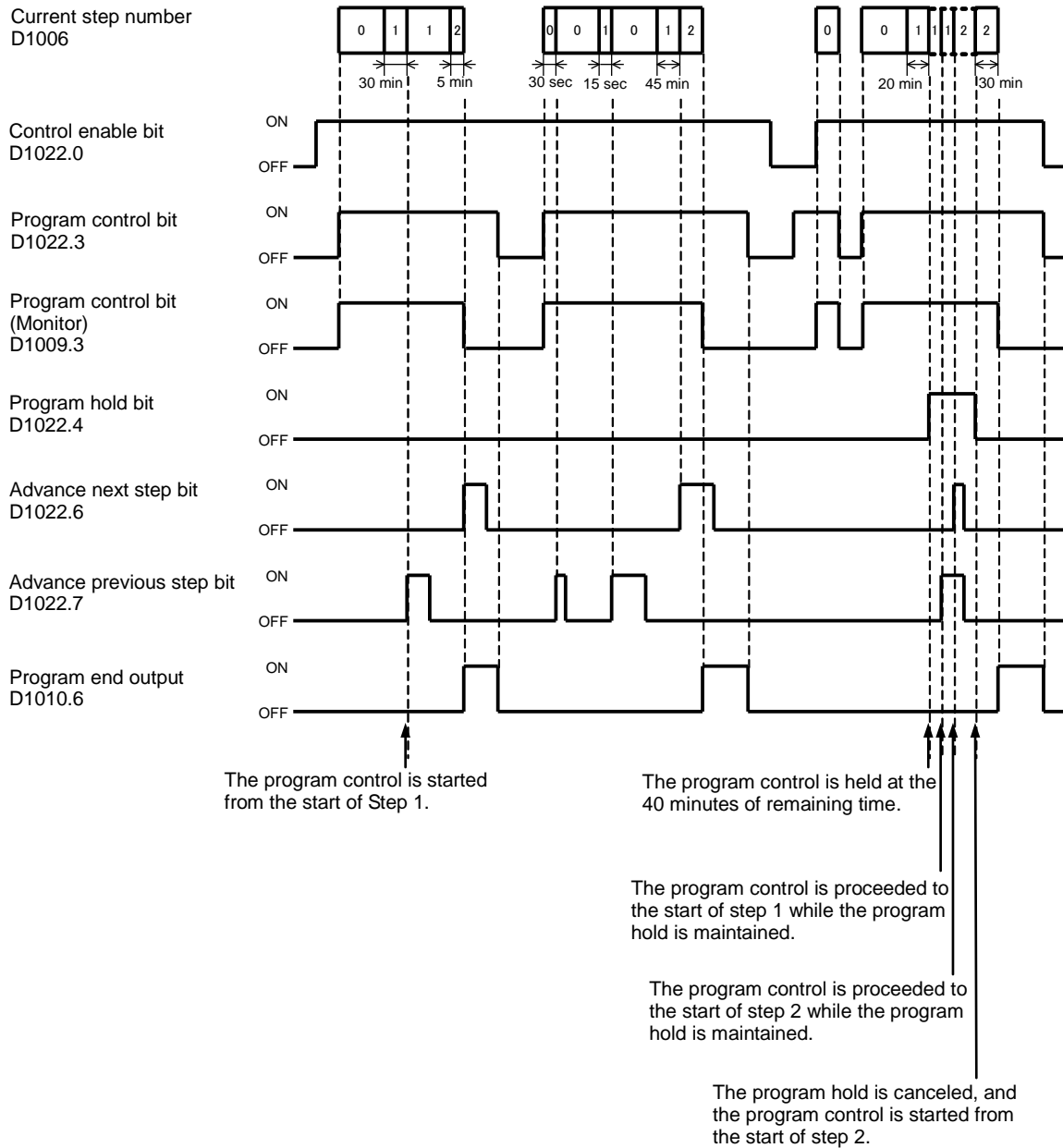

Note: The PID module executes all steps 0 to 9 even if the step times of steps are zero. When the program control is terminated, nine is stored in the current step number of block 0.

Example 2: Continue Program Control (Repeat) when Program Ends

The following diagram shows an example of the program control when continue program control (repeat) is selected as the program end action.

Time of steps: Step 0 and 1: 60 minutes, Step 2: 30 minutes, Steps 3 to 9: 0 minute

Number of repeats: 1

In this example, D1000 is allocated to the control register and M500 is allocated to control relay.

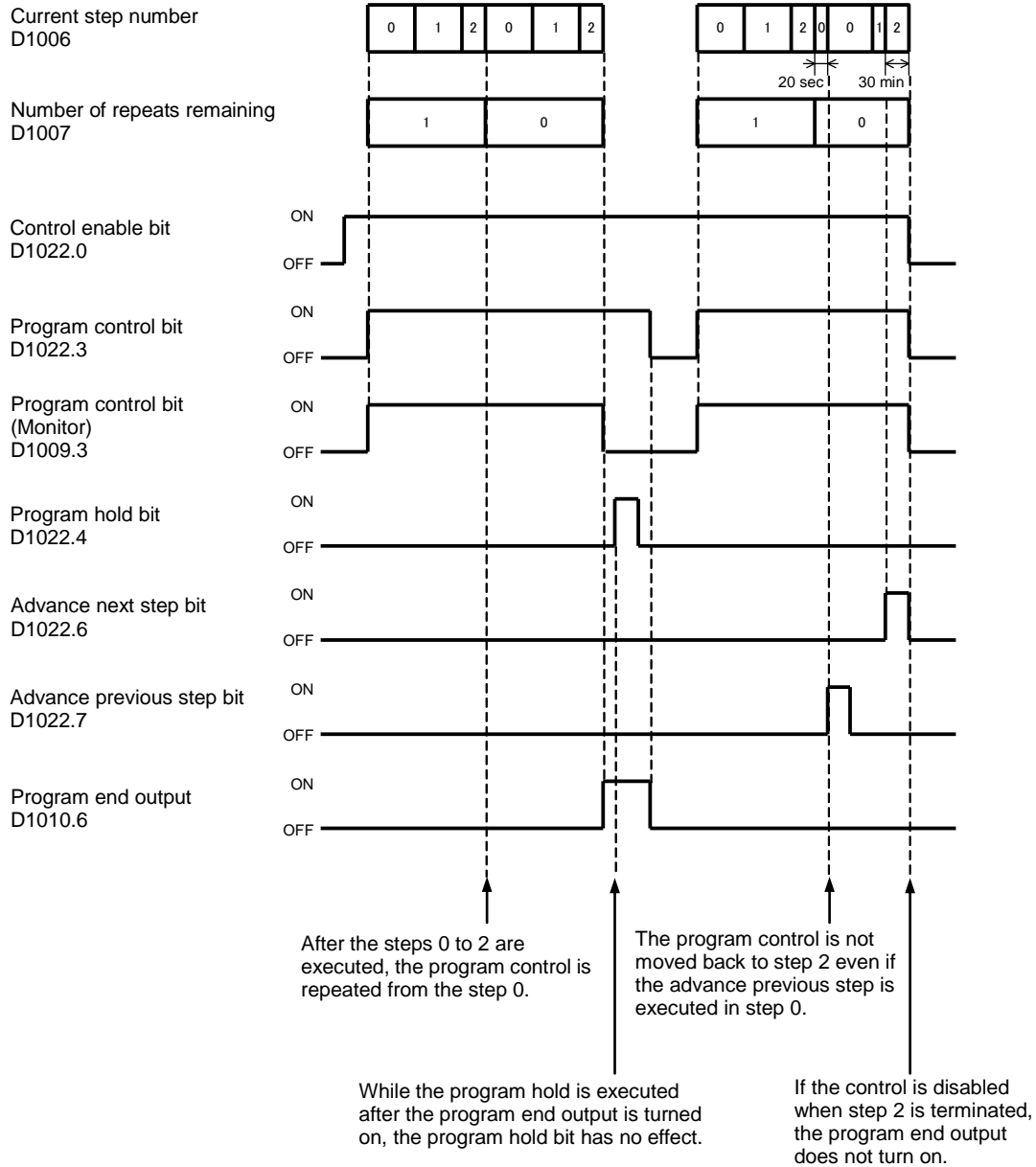

Example 3: Continue Program Control (Repeat) when Program Ends

The following diagram shows an example of the program control when continue program control (repeat) is selected as the program end action.

Time of steps: Step 0 and 1: 60 minutes, Step 2: 30 minutes, Steps 3 to 9: 0 minute

Number of repeats: 1

In this example, D1000 is allocated to the control register and M500 is allocated to control relay.

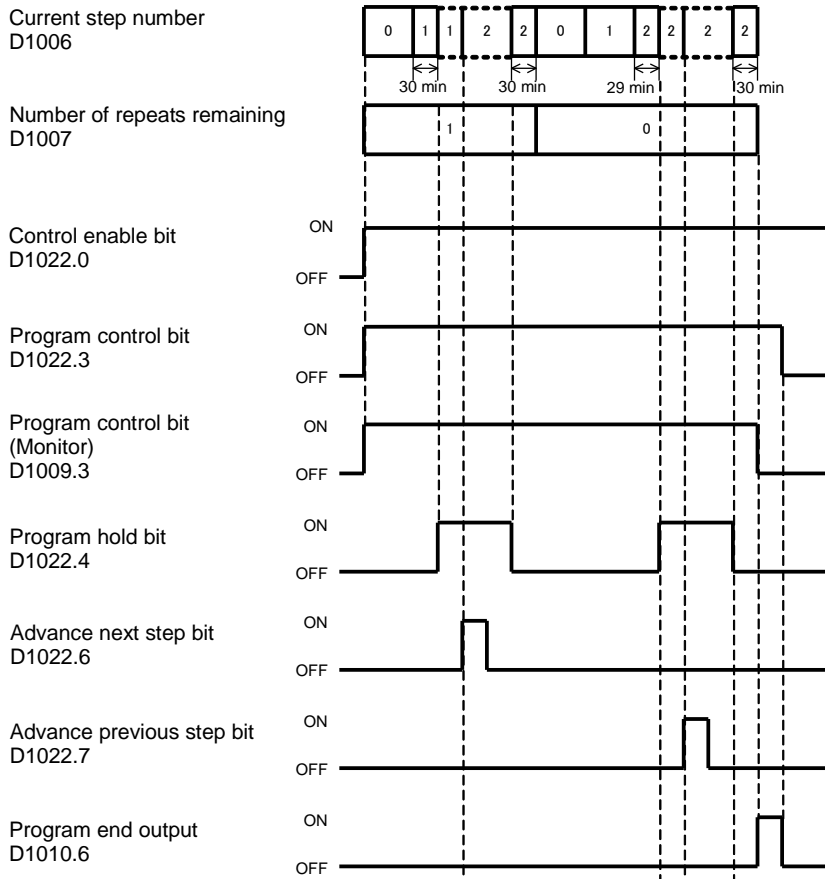

The program control is proceeded to the start of step 2 while the program hold is maintained.

The program control is held at 1 minute of the remaining time. (The program hold works when the remaining time is not zero.)

The program control is proceeded to the start of step 2 while the program hold is maintained.

The program hold is canceled, and the program control is started from the start of step 2.

Example 4: Hold Program Control when Program Ends

The following diagram shows an example of the program control when hold program control is selected as the program end action.

Time of steps: Step 0 and 1: 60 minutes, Step 2: 30 minutes, Steps 3 to 9: 0 minute

In this example, D1000 is allocated to the control register and M500 is allocated to control relay.

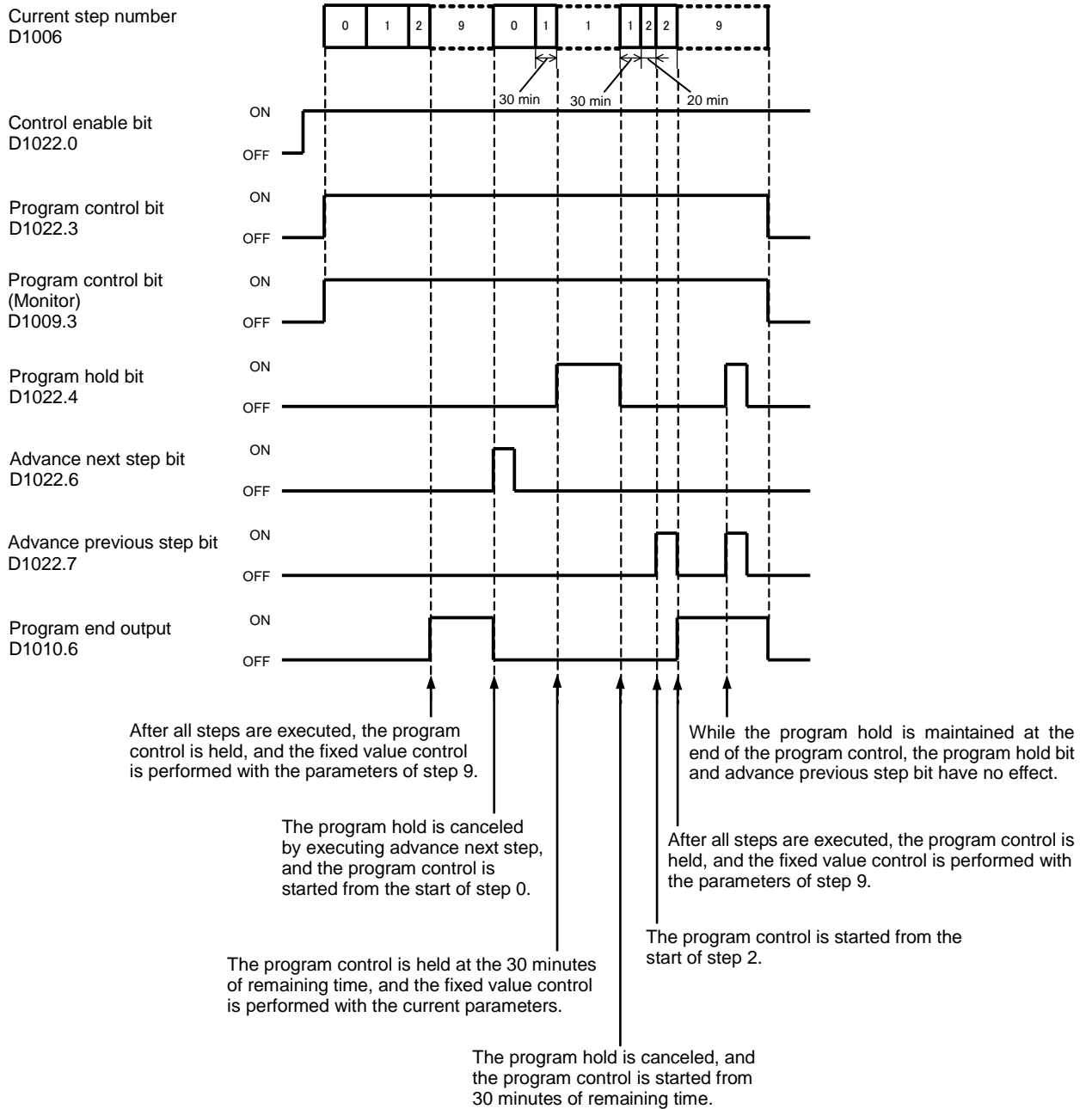

Note: The PID module executes all steps 0 to 9 even if the step times of steps are zero. When the program control is terminated, nine is stored in the current step number of block 0.

Example 5: Hold Program Control when Program Ends

The following diagram shows an example of the program control when hold program control is selected as the program end action.

Time of steps: Step 0 and 1: 60 minutes, Step 2: 30 minutes, Steps 3 to 9: 0 minute

In this example, D1000 is allocated to the control register and M500 is allocated to control relay.

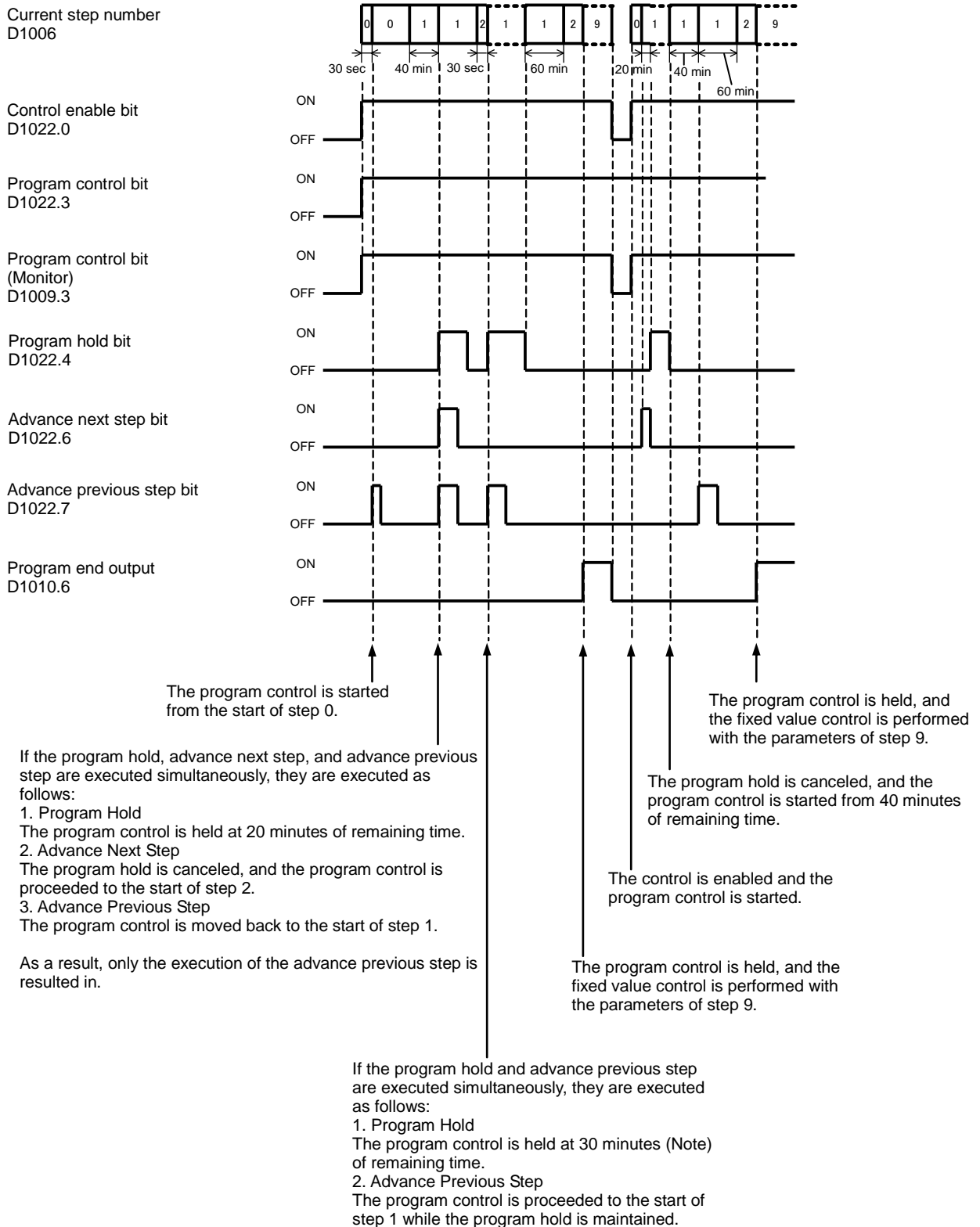

Note: If minute is selected as the step time unit, the remaining time is handled with the unit of minute. If the remaining time is between 29 minutes 1 second and 30 minutes 0 second, the remaining time will be 30 minutes.

Example 6: Hold Program Control when Program Ends

The following diagram shows an example of the program control when hold program control is selected as the program end action.

Time of steps: Step 0 and 1: 60 minutes, Step 2: 30 minutes, Steps 3 to 9: 0 minute

In this example, D1000 is allocated to the control register and M500 is allocated to control relay.

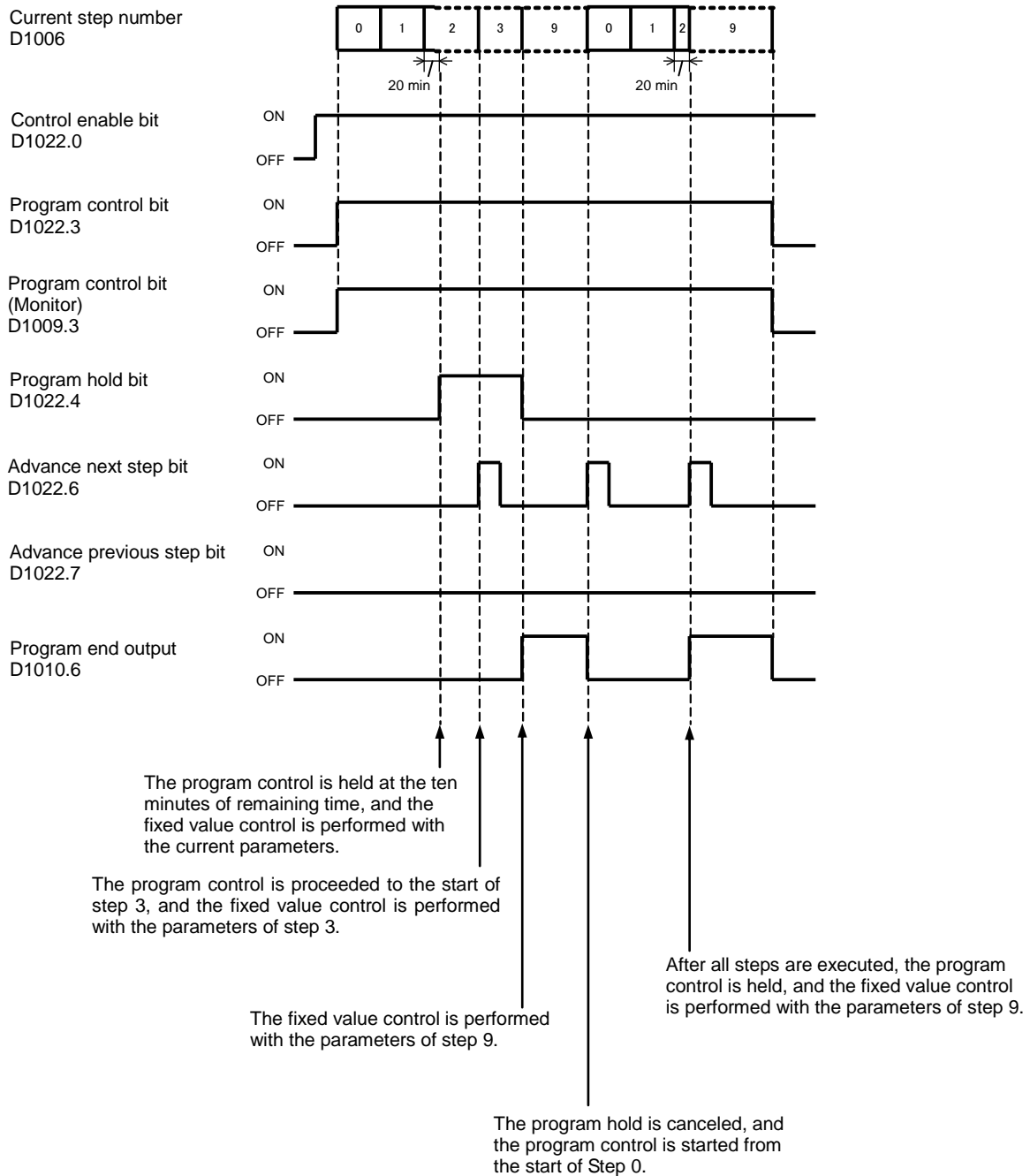

Notes:

- The PID module executes all steps 0 to 9 even if the times of steps are zero. When the program control is terminated, nine is stored in the current step number of block 0.
- When hold program control is selected as the program end action, the program control is held, and the fixed value control is performed with the parameters of step 9 after all steps are executed.

Data Register Allocation - Blocks 2, 3 Basic Parameters (SHOT Action)

Block 2 (CH0) and block 3 (CH1) parameters are shown in the table below. The parameters of block 2 and 3 can be changed while the control of the PID module is enabled.

Offset from the Control Register		Parameter	Description	R/W
CH0	CH1			
+26	+103	Proportional Term	Proportional band: When input range unit is Celsius: 0 to 10000°C (Range with a decimal point: 0.0 to 1000.0°C) When input range unit is Fahrenheit: 0 to 10000°F (Range with a decimal point: 0.0 to 1000.0°F) When input is voltage or current input: 0.0 to 1000.0% Proportional gain: 0.00 to 100.00%	R/W
+27	+104	Integral Time	0 to 10000 sec	R/W
+28	+105	Derivative Time	0 to 10000 sec	R/W
+29	+106	ARW (Anti-Reset Windup)	0 to 100%	R/W
+30	+107	Control Period	1 to 120 sec	R/W
+31	+108	Reset	When input range unit is Celsius: -100.0 to 100.0 °C When input range unit is Fahrenheit: -100.0 to 100.0 °F When input is voltage or current input: -1000 to 1000	R/W
+32	+109	Output Manipulated Variable Rate-of-Change	0 to 100%/sec	R/W
+33	+110	Set Point (SP) Rise Rate	When input range unit is Celsius: 0 to 10000°C/min (Range with a decimal point: 0.0 to 1000.0°C/min) When input range unit is Fahrenheit: 0 to 10000°F/min (Range with a decimal point: 0.0 to 1000.0°F/min) When input is voltage or current input: 0 to 10000/min	R/W
+34	+111	Set Point (SP) Fall Rate	When input range unit is Celsius: 0 to 10000°C/min (Range with a decimal point: 0.0 to 1000.0°C/min) When input range unit is Fahrenheit: 0 to 10000°F/min (Range with a decimal point: 0.0 to 1000.0°F/min) When input is voltage or current input: 0 to 10000/min	R/W
+35	+112	Loop Break Alarm (LA) Time	0 to 200 minutes	R/W
+36	+113	Loop Break Alarm (LA) Span	When input range unit is Celsius: 0 to 150 °C (Range with a decimal point: 0.0 to 150.0°C) When input range unit is Fahrenheit: 0 to 150 °F (Range with a decimal point: 0.0 to 150.0°F) When input is voltage or current input: 0 to 1500	R/W
+37	+114	Alarm 1 Value	See 5-18 for the valid range of alarm 1 to alarm 8 values.	R/W
+38	+115	Alarm 2 Value		R/W
+39	+116	Alarm 3 Value		R/W
+40	+117	Alarm 4 Value		R/W
+41	+118	Alarm 5 Value		R/W
+42	+119	Alarm 6 Value		R/W
+43	+120	Alarm 7 Value		R/W
+44	+121	Alarm 8 Value		R/W
+45	+122	Reserved		R/W

+46	+123	Output Manipulated Variable Upper Limit	When output type is relay or voltage: Output manipulated variable lower limit to 100% When output type is current: Output manipulated variable lower limit to 105%	R/W
+47	+124	Output Manipulated Variable Lower Limit	When output type is relay or voltage: 0% to output manipulated variable upper limit When output type is current: -5% to output manipulated variable upper limit	R/W
+48	+125	Cooling Proportional Band (CH0 only)	0.0 to 10.0 times (Cooling proportional band is the multiplication of heating proportional band)	R/W
+49	+126	Cooling Control Period (CH0 only)	1 to 120 sec	R/W
+50	+127	Overlap/Dead Band (CH0 only)	When input range unit is Celsius: -200.0 to 200.0°C When input range unit is Fahrenheit: -200.0 to 200.0°F When input is voltage or current input: -2000 to 2000	R/W
+51	+128	Cooling Output Manipulated Variable Upper Limit (CH0 only)	When output type is relay or voltage: Cooling output manipulated variable lower limit to 100% When output type is current: Cooling output manipulated variable lower limit to 105%	R/W
+52	+129	Cooling Output Manipulated Variable Lower Limit (CH0 only)	When output type is relay or voltage: 0% to cooling output manipulated variable upper limit When output type is current: -5% to cooling output manipulated variable upper limit	R/W

Valid Range for Alarm 1 to Alarm 8 Settings

Alarm Type	Valid Range
Upper Limit Alarm	-(Full scale) to full scale *1
Lower Limit Alarm	-(Full scale) to full scale *1
Upper/Lower Limits Alarm	0 to full scale *1
Upper/Lower Limit Range Alarm	0 to full scale *1
Process High Alarm	Input range lower limit to input range upper limit *2
Process Low Alarm	Input range lower limit to input range upper limit *2
Upper Limit Alarm with Standby	-(Full scale) to full scale *1
Lower Limit Alarm with Standby	-(Full scale) to full scale *1
Upper/Lower Limits Alarm with Standby	0 to full scale *1

*1: When input is voltage/current, full scale is the linear conversion span.

*2: When input is voltage/current, the valid range is the linear conversion minimum value to linear conversion maximum value.

Data Register Allocation - Blocks 4, 5 Initial Setting Parameters (SHOT Action)

Block 4 (CH0) and block 5(CH1) parameters are shown in the table below. Before changing the parameters of block 4 or 5, it is recommended that the control of the PID module be disabled.

Offset from the Control Register		Parameter	Description	R/W
CH0	CH1			
+53	+130	Control Action	0: Reverse control action (Heating) 1: Direct control action (Cooling)	R/W
+54	+131	Heating/Cooling Control (CH0 only)	0: Disable 1: Enable	R/W
+55	+132	External SP Input (CH0 only)	0: Disabled 1: External SP input (4 to 20mA DC) 2: External SP input (0 to 20mA DC) 3: External SP input (1 to 5V DC) 4: External SP input (0 to 1V DC) 5: Cascade control	R/W
+56	+133	Input Function	0: Input (CH0/CH1) 1: Difference input (CH0 - CH1) 2: Difference input (CH1 - CH0) 3: Addition input (CH0 + CH1)	R/W
+57	-	Output Function (CH0)	0: Output (CH0) 1: Output (CH1) 2: Both outputs (CH0, CH1)	R/W
-	+134	Output Function (CH1)	0: Output(CH1) Output Function (CH0) has priority.	R/W
+58	+135	Input Type	See 5-21 for the input types and range	R/W
+59	+136	Set Point (SP) Upper Limit/ Linear Conversion Maximum Value	When input is thermocouple or resistance thermometer: Set point (SP) lower limit to input range upper limit When input is voltage or current input: Linear conversion minimum to input range upper limit	R/W
+60	+137	Set Point (SP) Lower Limit/ Linear Conversion Minimum Value	When input is thermocouple or resistance thermometer: Input range lower limit to set point (SP) upper limit When input is voltage or current input: Input range lower limit to linear conversion maximum	R/W
+61	+138	Output ON/OFF Hysteresis	When input range unit is Celsius: 0.1 to 100.0°C When input range unit is Fahrenheit: 0.1 to 100.0°F When input is voltage or current input: 1 to 1000	R/W
+62	+139	PV Correction	When input range unit is Celsius: -100.0 to 100.0°C When input range unit is Fahrenheit: -100.0 to 100.0°F When input is voltage or current input: -1000 to 1000	R/W
+63	+140	PV Filter Time Constant	0.0 to 10.0 sec	R/W
+64	+141	Reserved		R/W
+65	+142	Alarm 1 Type	0: No alarm action	R/W
+66	+143	Alarm 2 Type	1: Upper limit alarm	R/W
+67	+144	Alarm 3 Type	2: Lower limit alarm	R/W
+68	+145	Alarm 4 Type	3: Upper/Lower limits alarm	R/W
+69	+146	Alarm 5 Type	4: Upper/Lower limit range alarm	R/W
+70	+147	Alarm 6 Type	5: Process high alarm	R/W
+71	+148	Alarm 7 Type	6: Process low alarm	R/W
+72	+149	Alarm 8 Type	7: Upper limit alarm with standby 8: Lower limit alarm with standby 9: Upper/Lower limits alarm with standby	R/W

+73	+150	Alarm 1 Hysteresis	When input range unit is Celsius: 0.1 to 100.0°C When input range unit is Fahrenheit: 0.1 to 100.0°F When input is voltage or current input: 1 to 1000	R/W
+74	+151	Alarm 2 Hysteresis		R/W
+75	+152	Alarm 3 Hysteresis		R/W
+76	+153	Alarm 4 Hysteresis		R/W
+77	+154	Alarm 5 Hysteresis		R/W
+78	+155	Alarm 6 Hysteresis		R/W
+79	+156	Alarm 7 Hysteresis		R/W
+80	+157	Alarm 8 Hysteresis		R/W
+81	+158	Alarm 1 Delay Time	0 to 10000 sec	R/W
+82	+159	Alarm 2 Delay Time		R/W
+83	+160	Alarm 3 Delay Time		R/W
+84	+161	Alarm 4 Delay Time		R/W
+85	+162	Alarm 5 Delay Time		R/W
+86	+163	Alarm 6 Delay Time		R/W
+87	+164	Alarm 7 Delay Time		R/W
+88	+165	Alarm 8 Delay Time		R/W
+89	+166	AT Bias	When input range unit is Celsius: 0 to 50 °C (0.0 to 50.0°C for input with decimal point) When input range unit is Fahrenheit: 0 to 100 °F (0.0 to 100.0°F for input with decimal point)	R/W
+90	+167	Control Mode	0: Fixed value control mode 1: Program control mode	R/W
+91	+168	Program Control Mode Start Type	0: PV start 1: PVR start 2: SP start	R/W
+92	+169	Step Time Unit	0: Minute 1: Second	R/W
+93	+170	Program End Action	0: Terminate program control 1: Continue program control (Repeat) 2: Hold program control	R/W
+94	+171	Proportional Term	0: Proportional band 1: Proportional gain	R/W
+95	+172	Cooling Method (CH0 only)	0: Air cooling 1: Oil cooling 2: Water cooling	R/W
+96	+173	Set Point (SP) when Program Control Starts	When input is thermocouple or resistance thermometer: Set point (SP) lower limit to set point (SP) upper limit When input is voltage or current input: Linear conversion min. to linear conversion max.	R/W
+97	+174	Number of Repeats	0 to 10000 times	R/W
+98	+175	Cooling Output ON/OFF Hysteresis (CH0 only)	When input range unit is Celsius: 0.1 to 100.0°C When input range unit is Fahrenheit: 0.1 to 100.0°F When input is voltage or current input: 1 to 1000	R/W
+99	+176	Output Type (FC5A-F2M2 only)	0: Non-contact voltage output (for SSR drive) 1: Current output	R/W
+100	+177	External SP Input Bias (CH1 only)	±20% of the external SP input linear conversion span	R/W
+101	+178	External SP Input Linear Conversion Maximum Value (CH1 only)	External SP input Linear conversion min. to input range upper limit	R/W
+102	+179	External SP Input Linear Conversion Minimum Value (CH1 only)	Input range lower limit to external SP input linear conversion max.	R/W

Input Range

Input Range		Range		Unit		
		PV	PV1/PV2	PV	PV1/PV2	
00h	Type K Thermocouple	Celsius	-200 to 1370°C	-200.0 to 1370.0°C	1°C	0.1°C
01h	Type K Thermocouple with Decimal Point		-200.0 to 400.0°C	-200.0 to 400.0°C	0.1°C	
02h	Type J Thermocouple		-200 to 1000°C	-200.0 to 1000.0°C	1°C	
03h	Type R Thermocouple		0 to 1760°C	0.0 to 1760.0°C	1°C	
04h	Type S Thermocouple		0 to 1760°C	0.0 to 1760.0°C	1°C	
05h	Type B Thermocouple		0 to 1820°C	0.0 to 1820.0°C	1°C	
06h	Type E Thermocouple		-200 to 800°C	-200.0 to 800.0°C	1°C	
07h	Type T Thermocouple		-200.0 to 400.0°C	-200.0 to 400.0°C	0.1°C	
08h	Type N Thermocouple		-200 to 1300°C	-200.0 to 1300.0°C	1°C	
09h	PL- II		0 to 1390°C	0.0 to 1390.0°C	1°C	
0Ah	C(W/Re5-26)		0 to 2315°C	0.0 to 2315.0°C	1°C	
0Bh	Pt100 with Decimal Point		-200.0 to 850.0°C	-200.0 to 850.0°C	0.1°C	
0Ch	JPt100 with Decimal Point		-200.0 to 500.0°C	-200.0 to 500.0°C	0.1°C	
0Dh	Pt100		-200 to 850°C	-200.0 to 850.0°C	1°C	
0Eh	JPt100		-200 to 500°C	-200.0 to 500.0°C	1°C	
0Fh	Type K Thermocouple		Fahrenheit	-328 to 2498°F	-328.0 to 2498.0°F	
10h	Type K Thermocouple with Decimal Point	-328.0 to 752.0°F		-328.0 to 752.0°F	0.1°F	
11h	Type J Thermocouple	-328 to 1832°F		-328.0 to 1832.0°F	1°F	
12h	Type R Thermocouple	32 to 3200°F		32.0 to 3200.0°F	1°F	
13h	Type S Thermocouple	32 to 3200°F		32.0 to 3200.0°F	1°F	
14h	Type B Thermocouple	32 to 3308°F		32.0 to 3308.0°F	1°F	
15h	Type E Thermocouple	-328 to 1472°F		-328.0 to 1472.0°F	1°F	
16h	Type T Thermocouple	-328.0 to 752.0°F		-328.0 to 752.0°F	0.1°F	
17h	Type N Thermocouple	-328 to 2372°F		-328.0 to 2372.0°F	1°F	
18h	PL- II	32 to 2534°F		32.0 to 2534.0°F	1°F	
19h	C(W/Re5-26)	32 to 4199°F		32.0 to 4199.0°F	1°F	
1Ah	Pt100 with Decimal Point	-328.0 to 1562.0°F		-328.0 to 1562.0°F	0.1°F	
1Bh	JPt100 with Decimal Point	-328.0 to 932.0°F		-328.0 to 932.0°F	0.1°F	
1Ch	Pt100	-328 to 1562°F		-328.0 to 1562.0°F	1°F	
1Dh	JPt100	-328 to 932°F		-328.0 to 932.0°F	1°F	
1Eh	4 to 20mA	-		-2000 to 10000(*1)	-2000 to 10000	1
1Fh	0 to 20mA					
20h	0 to 1V					
21h	0 to 5V					
22h	1 to 5V					
23h	0 to 10V					

(*1) Linear conversion is possible in the range of minimum linear conversion value to maximum linear conversion value.

Data Register Allocation - Blocks 10-19 CH0 Program Parameters (SHOT Action)

When CH0 control is in program control mode, block 10 to 19 should be configured. A maximum of ten steps from step 0 to step 9 can be configured. All parameters of block 10 to 19 are shown in the following tables. For detail about each parameter, see page 5-23.

Offset from the Control Register					Parameter
Step 0	Step 1	Step 2	Step 3	Step 4	
+180	+201	+222	+243	+264	Set point (SP)
+181	+202	+223	+244	+265	Step time
+182	+203	+224	+245	+266	Wait value
+183	+204	+225	+246	+267	Proportional term
+184	+205	+226	+247	+268	Integral time
+185	+206	+227	+248	+269	Derivative time
+186	+207	+228	+249	+270	ARW (Anti-Reset Windup)
+187	+208	+229	+250	+271	Output manipulated variable rate-of-change
+188	+209	+230	+251	+272	Alarm 1 value
+189	+210	+231	+252	+273	Alarm 2 value
+190	+211	+232	+253	+274	Alarm 3 value
+191	+212	+233	+254	+275	Alarm 4 value
+192	+213	+234	+255	+276	Alarm 5 value
+193	+214	+235	+256	+277	Alarm 6 value
+194	+215	+236	+257	+278	Alarm 7 value
+195	+216	+237	+258	+279	Alarm 8 value
+196	+217	+238	+259	+280	Reserved
+197	+218	+239	+260	+281	Output manipulated variable upper limit
+198	+219	+240	+261	+282	Output manipulated variable lower limit
+199	+220	+241	+262	+283	Cooling proportional band
+200	+221	+242	+263	+284	Overlap/Dead band

Offset from the Control Register					Parameter
Step 5	Step 6	Step 7	Step 8	Step 9	
+285	+306	+327	+348	+369	Set point (SP)
+286	+307	+328	+349	+370	Step time
+287	+308	+329	+350	+371	Wait value
+288	+309	+330	+351	+372	Proportional term
+289	+310	+331	+352	+373	Integral time
+290	+311	+332	+353	+374	Derivative time
+291	+312	+333	+354	+375	ARW (Anti-Reset Windup)
+292	+313	+334	+355	+376	Output manipulated variable rate-of-change
+293	+314	+335	+356	+377	Alarm 1 value
+294	+315	+336	+357	+378	Alarm 2 value
+295	+316	+337	+358	+379	Alarm 3 value
+296	+317	+338	+359	+380	Alarm 4 value
+297	+318	+339	+360	+381	Alarm 5 value
+298	+319	+340	+361	+382	Alarm 6 value
+299	+320	+341	+362	+383	Alarm 7 value
+300	+321	+342	+363	+384	Alarm 8 value
+301	+322	+343	+364	+385	Reserved
+302	+323	+344	+365	+386	Output manipulated variable upper limit
+303	+324	+345	+366	+387	Output manipulated variable lower limit
+304	+325	+346	+367	+388	Cooling proportional band
+305	+326	+347	+368	+389	Overlap/Dead band

Program Parameters

Parameter	Description	R/W
Set Point (SP)	When input is thermocouple or resistance thermometer: Set point (SP) lower limit to set point (SP) upper limit When input is voltage or current input: Linear conversion min. to linear conversion max.	R/W
Step Time	When step time unit is Minute: 0 to 6000 minutes When step time unit is Second: 0 to 6000 seconds	R/W
Wait Value	When input range unit is Celsius: 0 to 100°C (Range with a decimal point: 0.0 to 100.0°C) When input range unit is Fahrenheit: 0 to 100°F (Range with a decimal point: 0.0 to 100.0°F) When input is voltage or current input: 0 to 1000	R/W
Proportional Term	Proportional band: When input range unit is Celsius: 0 to 10000°C (Range with a decimal point: 0.0 to 1000.0°C) When input range unit is Fahrenheit: 0 to 10000°F (Range with a decimal point: 0.0 to 1000.0°F) When input is voltage or current input: 0.0 to 1000.0% Proportional gain: 0.00 to 100.00%	R/W
Integral Time	0 to 10000 sec	R/W
Derivative Time	0 to 10000 sec	R/W
ARW (Anti-Reset Windup)	0 to 100%	R/W
Output Manipulated Variable Rate-of-Change	0 to 100%/sec	R/W
Alarm 1 Value	See 5-18 for the valid range of alarm 1 to alarm 8 values.	R/W
Alarm 2 Value		R/W
Alarm 3 Value		R/W
Alarm 4 Value		R/W
Alarm 5 Value		R/W
Alarm 6 Value		R/W
Alarm 7 Value		R/W
Alarm 8 Value		R/W
Reserved		R/W
Output Manipulated Variable Upper Limit	When output type is relay or voltage: Output manipulated variable lower limit to 100% When output type is current: Output manipulated variable lower limit to 105%	R/W
Output Manipulated Variable Lower Limit	When output type is relay or voltage: 0% to output manipulated variable upper limit When output type is current: -5% to output manipulated variable upper limit	R/W
Cooling Proportional Band (CH0 only)	0.0 to 10.0 times (Cooling proportional band is the multiplication of heating proportional band)	R/W
Overlap/Dead Band (CH0 only)	When input range unit is Celsius: -200.0 to 200.0°C When input range unit is Fahrenheit: -200.0 to 200.0°F When input is voltage or current input: -2000 to 2000	R/W

Data Register Allocation - Blocks 30-39 CH1 Program Parameters (SHOT Action)

When CH1 control is in program control mode, block 30 to 39 should be configured. A maximum of ten steps from step 0 to step 9 can be configured. All parameters of block 30 to 39 are shown in the following tables. For detail about each parameter, see page 5-23.

Offset from the Control Register					Parameter
Step 0	Step 1	Step 2	Step 3	Step 4	
+390	+409	+428	+447	+466	Set point (SP)
+391	+410	+429	+448	+467	Step time
+392	+411	+430	+449	+468	Wait value
+393	+412	+431	+450	+469	Proportional term
+394	+413	+432	+451	+470	Integral time
+395	+414	+433	+452	+471	Derivative time
+396	+415	+434	+453	+472	ARW (Anti-Reset Windup)
+397	+416	+435	+454	+473	Output manipulated variable rate-of-change
+398	+417	+436	+455	+474	Alarm 1 value
+399	+418	+437	+456	+475	Alarm 2 value
+400	+419	+438	+457	+476	Alarm 3 value
+401	+420	+439	+458	+477	Alarm 4 value
+402	+421	+440	+459	+478	Alarm 5 value
+403	+422	+441	+460	+479	Alarm 6 value
+404	+423	+442	+461	+480	Alarm 7 value
+405	+424	+443	+462	+481	Alarm 8 value
+406	+425	+444	+463	+482	Reserved
+407	+426	+445	+464	+483	Output manipulated variable upper limit
+408	+427	+446	+465	+484	Output manipulated variable lower limit

Offset from the Control Register					Parameter
Step 5	Step 6	Step 7	Step 8	Step 9	
+485	+504	+523	+542	+561	Set point (SP)
+486	+505	+524	+543	+562	Step time
+487	+506	+525	+544	+563	Wait value
+488	+507	+526	+545	+564	Proportional term
+489	+508	+527	+546	+565	Integral time
+490	+509	+528	+547	+566	Derivative time
+491	+510	+529	+548	+567	ARW (Anti-Reset Windup)
+492	+511	+530	+549	+568	Output manipulated variable rate-of-change
+493	+512	+531	+550	+569	Alarm 1 value
+494	+513	+532	+551	+570	Alarm 2 value
+495	+514	+533	+552	+571	Alarm 3 value
+496	+515	+534	+553	+572	Alarm 4 value
+497	+516	+535	+554	+573	Alarm 5 value
+498	+517	+536	+555	+574	Alarm 6 value
+499	+518	+537	+556	+575	Alarm 7 value
+500	+519	+538	+557	+576	Alarm 8 value
+501	+520	+539	+558	+577	Reserved
+502	+521	+540	+559	+578	Output manipulated variable upper limit
+503	+522	+541	+560	+579	Output manipulated variable lower limit

6: CONFIGURING PID MODULE USING WINDLDR

This chapter describes configuration procedure of the PID modules using WindLDR, PID module configuration dialogs, and monitoring.

Procedure to configure the PID module

1. Expansion Modules Configuration Dialog Box

To open the Expansion Modules Configuration dialog box, follow one of the procedures below.

Procedure 1:

1. From the WindLDR menu bar, select **View > Project Window** to open the Project Window.
2. Double-click on **Expansion Modules Configuration** in the Project Window.

Procedure 2:

1. From the WindLDR menu bar, select **Configuration > Expansion Modules**.

Expansion Modules Configuration Dialog Box

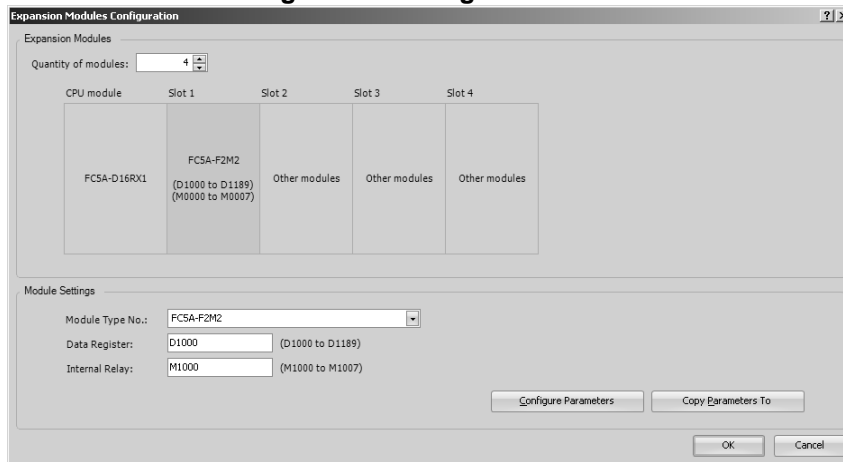

After specifying the quantity of modules and selecting the slot number to which the PID module is connected, designate the module type number, control register (data register) and control relay (internal relay). After designating those parameters, click on **Configure Parameters** button to open the PID Module Configuration dialog.

2. PID Module Configuration Dialog Box

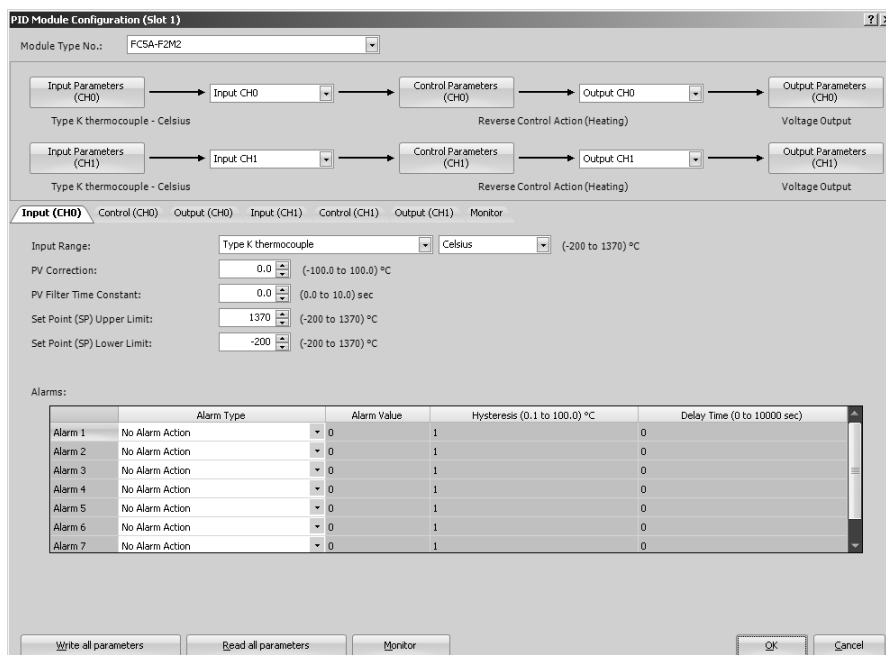

All parameters for the PID module can be configured in this dialog box. Configure the desired parameters and click on **OK** button to close the dialog.

3. Download Dialog Box

From the WindLDR menu bar, select **Online > Download**. The Download dialog box will be opened.

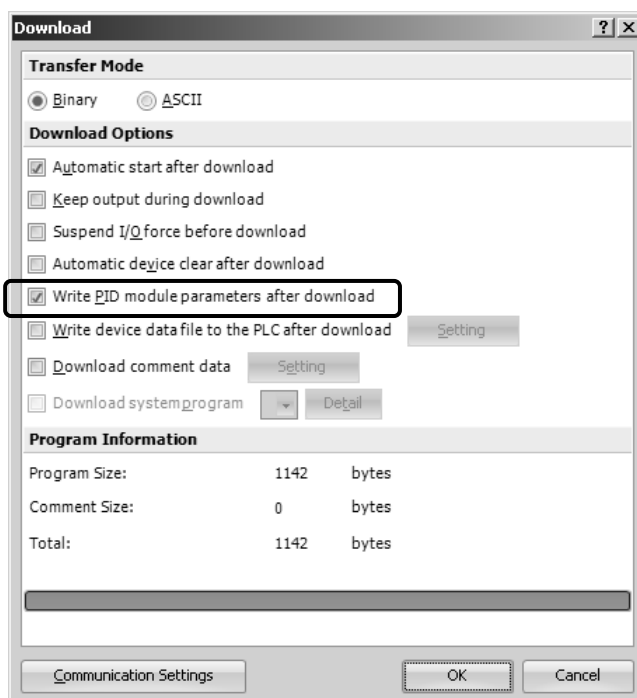

Click the check box on the left of **Write PID Module parameters after download** and click **OK** button. The user program will be downloaded. After downloading the user program, the PID module parameters will be automatically written to the data registers in the CPU module and the PID module connected to the CPU module.

Note: The CPU module and the connected PID module exchange data through the allocated data registers in the CPU module. In order for the CPU module to communicate with the PID Module, it is required that the user program be downloaded to the CPU module after configuring the PID Module in the Expansion Modules Configuration dialog box. In order for the PID module to operate, it is required that the parameters be written to the data registers in the CPU module and the PID module.

Writing and Reading Parameters

When Write All Parameters or Read All Parameters is executed in the PID Module Configuration dialog box, all parameters will be written to/read from the PID module as follows.

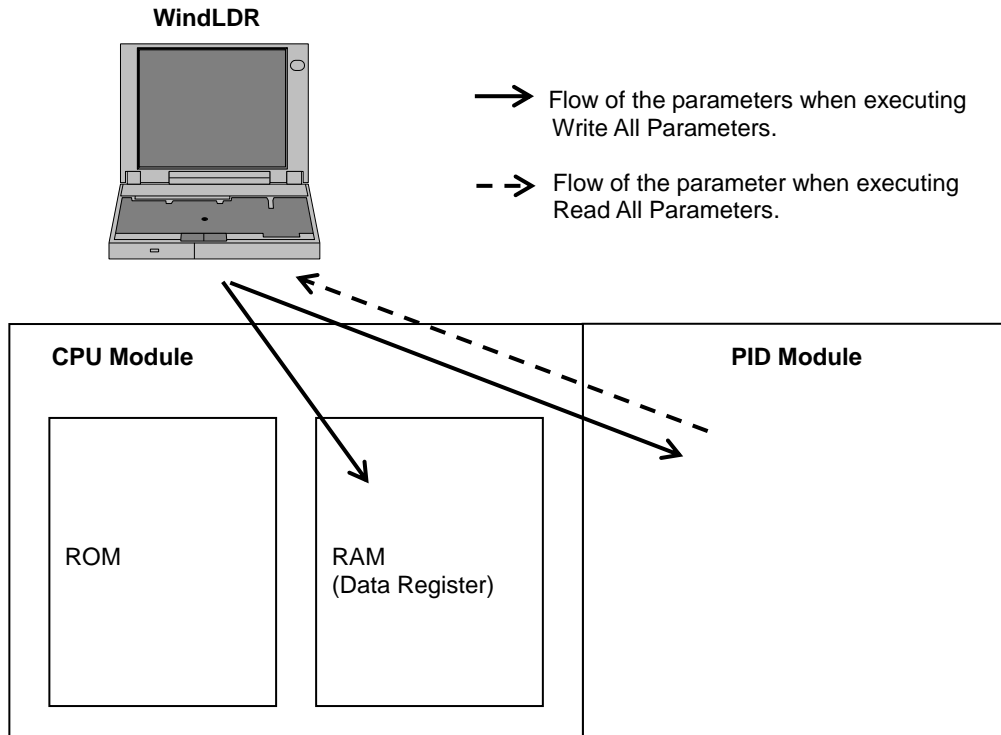

Downloading and Uploading User Program

When the user program download^{*1} or upload is executed, the user program is downloaded to/uploaded from the CPU module as follows.

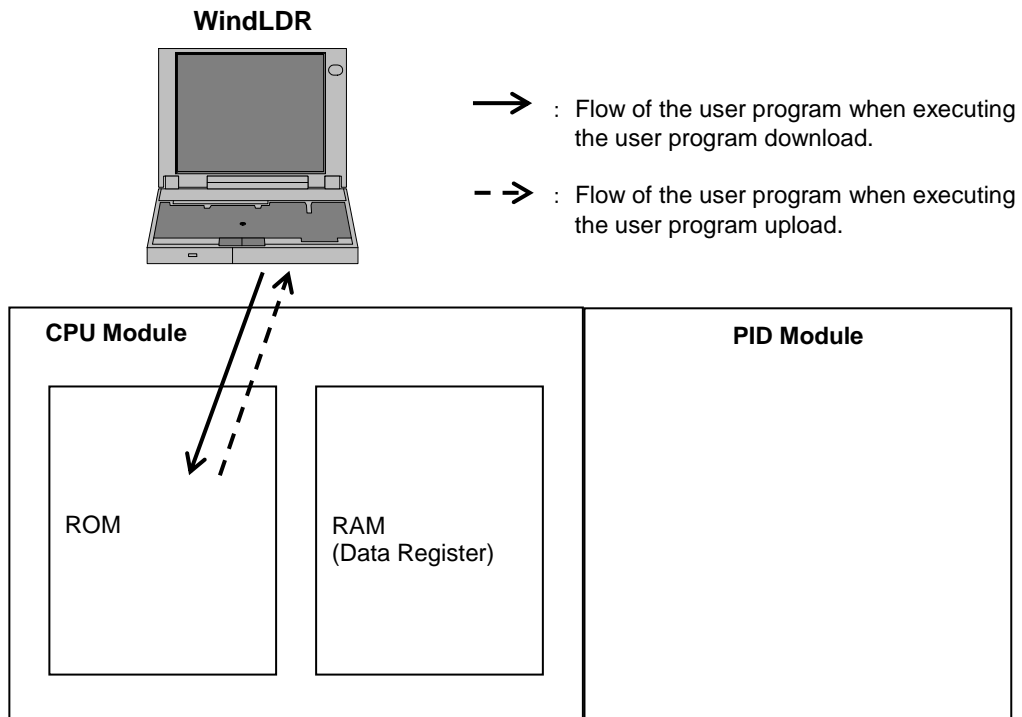

*1: When **Write PID Module parameters after download** is checked in the Download dialog, writing the PID module parameters will be executed after the user program is downloaded to the CPU module. The PID module parameters are written to the data registers in the CPU module and all PID modules configured in the Expansion Modules Configuration dialog box. For details, see the following page.

User Program Download

The user program contains the user program and the PID module parameters (initial values) configured in the PID Module Configuration dialog box. After the user program is downloaded to the CPU module, the CPU module can communicate with the PID Modules through the allocated data registers.

After the user program download, the following actions will be taken depending on whether **Write PID Module parameters after download** in the Download dialog box is checked or not.

When **Write PID Module parameters after download** is checked:

After the user program is downloaded to the CPU module, the PID module parameters configured in the PID Module Configuration dialog box are written to the CPU module and the connected PID modules.

When **Write PID Module parameters after download** is not checked:

After the user program is downloaded to the CPU module, the PID module parameters are not written to the PID module.

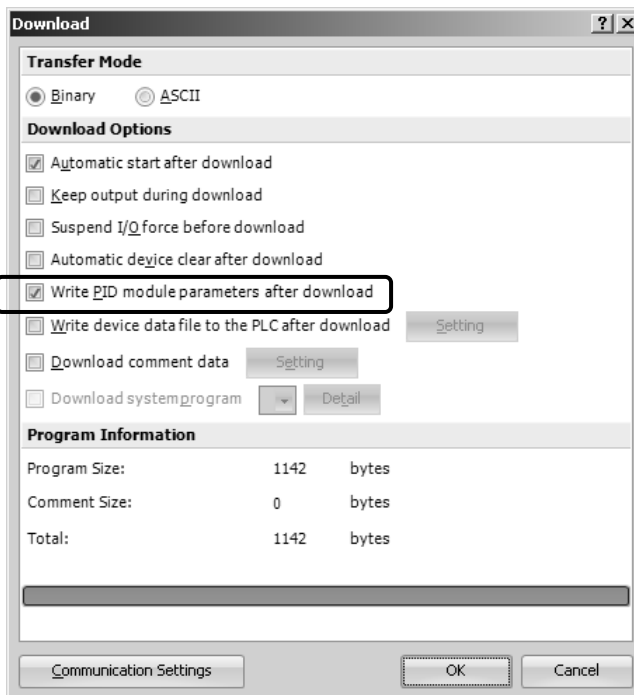

When **Write PID Module parameters after download** is checked, after the user program is downloaded to the CPU module, the PID module parameters configured in the PID Module Configuration dialog box will be written to the data registers in the CPU module and all PID modules configured in the Expansion Modules Configuration dialog box. However, if a PID module is not connected to the configured slot, writing parameters to the PID module will fail. Even after writing parameters to one PID module failed, WindLDR continues to write the parameters to all PID modules configured in the Expansion Modules Configuration dialog box.

If writing parameters fails, connect the PID module to the CPU module and write parameters to the PID module again.

To write the PID module parameters without downloading the user program to the CPU module, take the following steps:

1. Connect the PID module to the CPU module.
2. Open the PID Module Configuration dialog box for the slot.
3. Click on Write All Parameters button.

All the configured parameters will be written to the data registers in the CPU module and the PID module.

User Program Upload

When the user program containing the initial parameters of the PID modules is uploaded from the CPU module, the initial values will be restored. The parameters saved in the PID module will not be read.

How to restore data register values when a keep data error has occurred

If more than 30 days pass since the power to the CPU module is turned off, values stored in the data registers will be lost. When the data register values are lost, after the power is turned on, restore the PID module parameters in the data registers of the CPU module using either of the following methods, and then enable the control of the PID module.

Method 1: Use the parameters stored in the PID module

The parameters stored in the PID module can be read out and stored in the data registers of the CPU module with one of the following procedures:

Procedure 1: Using WindLDR

1. Open Expansion Modules Configuration dialog box in WindLDR.
2. Select the slot number of the connected PID module and open the PID Module Configuration dialog box.
3. Click on Read All Parameters button to read all parameters from the PID module.
4. Configure the set point (SP) and the manual mode output manipulated variable in the PID Module Configuration dialog box. *1
5. Click on Write All Parameters button.

When the control of the PID module is enabled, the PID module will start operating with the downloaded parameters.

Procedure 2: Using the user program

1. Turn off to on the reading all parameters relay (control relay + 0).
2. Configure the set point (SP) and the manual mode output manipulated variable if necessary. *1
When the control of the PID module is enabled, the PID module will start operating with the configured parameters.

*1: Because the block 1 parameters are not saved in the PID module, it is required to configure those parameters.

Method 2: Use the default parameters stored in the ROM of the CPU module

When the PID module parameters are configured in the PID Module Configuration dialog box and the user program is downloaded to the CPU module, the PID module parameters (initial values) will be saved in ROM of the CPU module. Those initial values can be loaded to the data registers in the CPU module, and the PID module can be operated with those initial values with the following procedure:

1. Turn off to on the loading initial values relay (control relay + 1).
2. Turn off to on the writing all parameters relay (control relay + 2).

When the control of the PID module is enabled, the PID module will start operating with the default values.

Expansion Modules Configuration Dialog Box

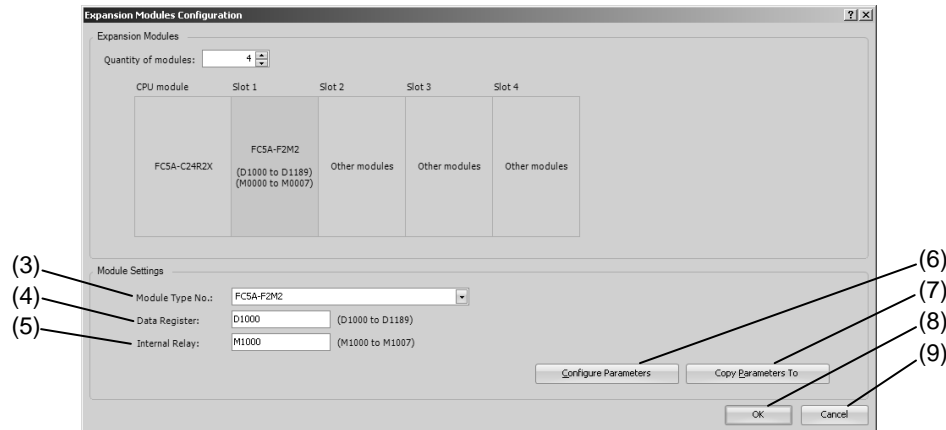
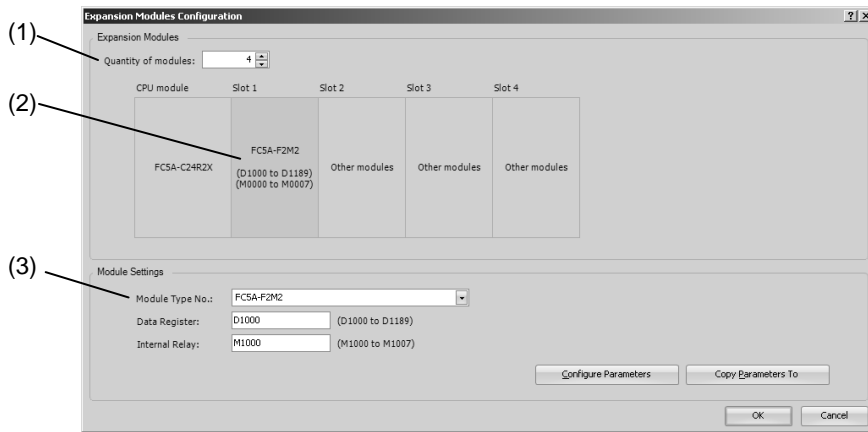

Settings

	Item	Description
(1)	Quantity of Modules	Configure the quantity of modules to be expanded. The quantity of PID modules can be connected varies with the CPU module type. A maximum of four PID modules can be connected to the all-in-one type CPU modules. A maximum of seven PID modules can be connected to the slim type CPU modules.
(2)	Slot Number	Select a slot number to configure the PID module.
(3)	Module Type No.	Select the type number of the PID module to configure. <div style="border: 1px solid gray; padding: 5px; margin: 5px 0;"> <p>Module Settings</p> <p>Module Type No.: FC5A-F2M2</p> <p>Data Register: Other modules FC5A-F2MR2</p> <p>Internal Relay: FC5A-F2M2 ICL-13A-RR/MM - SHINKO TECHNOS ICL-13A-AA/MM - SHINKO TECHNOS ICL-13A-RR/MM,W - SHINKO TECHNOS ICL-13A-AA/MM,W - SHINKO TECHNOS</p> </div>
(4)	Data Register	Designate the control register for the PID module. Data register can be designated. A maximum of 590 data registers (minimum 190 data registers) are occupied, including the first data register designated.
(5)	Internal Relay	Designate the control relay for the PID module. Internal relay can be designated. A maximum of 32 internal relays (minimum 8 internal relays) are occupied, including the first internal relay designated.

Buttons

	Button	Description
(6)	Configure Parameters	The PID Module Configuration dialog box is opened.
(7)	Copy Parameters To	The PID module parameters of the current slot can be copied to another slot.
(8)	OK	All parameters are saved and the dialog is closed.
(9)	Cancel	All changes made are discarded and the dialog is closed.

PID Module Configuration Dialog Box

The buttons in the PID module configuration dialog box are described.

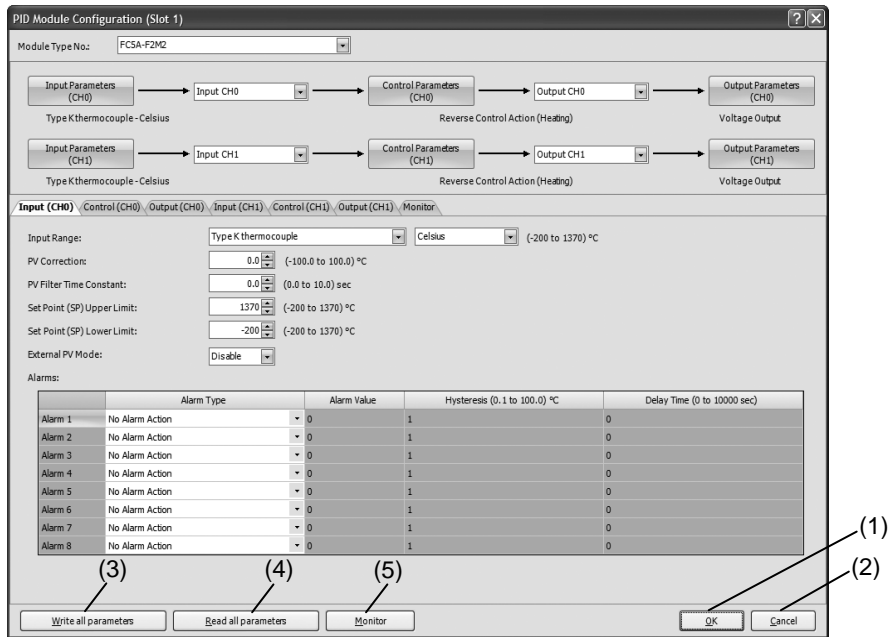

Buttons

	Button	Description
(1)	OK	All parameters are saved and the dialog is closed.
(2)	Cancel	All changes made to the parameters are discarded and the dialog is closed.
(3)	Write All Parameters	Current parameters configured in the PID Module Configuration dialog box are written to the data registers (RAM) in the CPU module and the PID module.
(4)	Upload All Parameters	All parameters stored in the PID module mounted on the slot selected in the Expansion Modules Configuration dialog box are read, and all parameters in the dialog box are updated.
(5)	Monitor	The PID module mounted on the slot selected in the Expansion Modules Configuration dialog box can be monitored.

PID Module Configuration - Input Parameters List (CH0 and CH1)

The input parameters for CH0 and CH1 controls are described here.

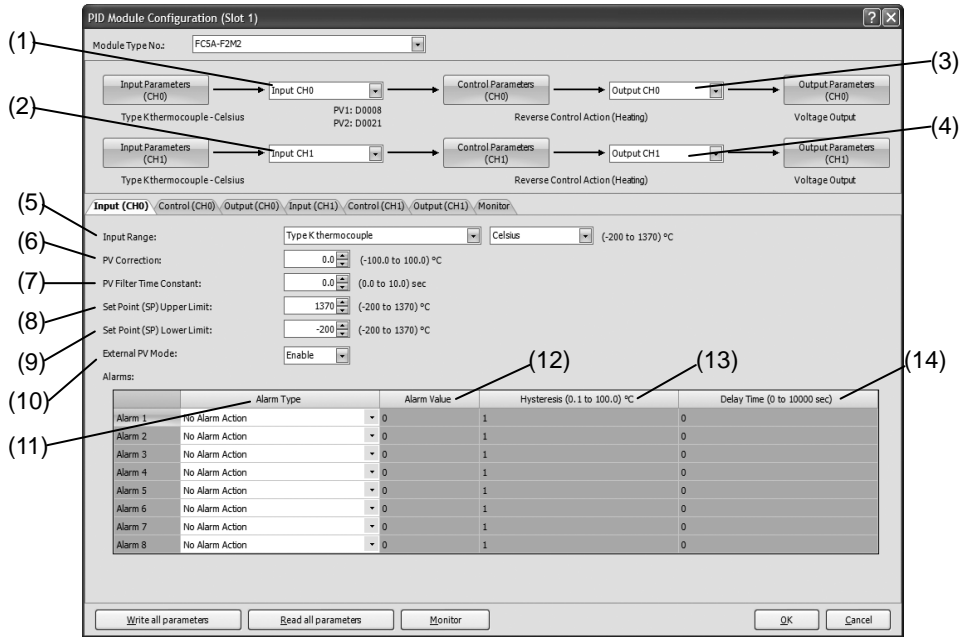

Control Registers

	Offset from the control register		Parameter	Description	R/W
	CH0	CH1			
(1)	+56	-	Input CH0 Function	0: Input CH0 1: Difference input (Input CH0 - Input CH1) 2: Difference input (Input CH1 - Input CH0) 3: Addition input (Input CH0 + Input CH1)	R/W
(2)	-	+133	Input CH1 Function	0: Input CH1 1: Difference input (Input CH0 - Input CH1) 2: Difference input (Input CH1 - Input CH0) 3: Addition input (Input CH0 + Input CH1)	R/W
	+55	-	External SP Input	0: Disabled 1: External SP input (4 to 20mA DC) (Note) 2: External SP input (0 to 20mA DC) 3: External SP input (1 to 5V DC) 4: External SP input (0 to 1V DC) 5: Cascade control (Note) Note: When External SP input is selected in Input CH1 Function, "1: External SP input (4 to 20mA DC)" is selected as the default. When Cascade Control is selected in Input CH1 Function, "5: Cascade control" is selected.	R/W
(3)	+57	-	Output CH0 Function	0: Output CH0 1: Output CH1 2: Both outputs (Output CH0, Output CH1)	R/W
(4)	-	+134	Output CH1 Function	0: Output CH1 (The selection of Output CH0 Function has priority.)	R/W
(5)	+58	+135	Input Range	See page 6-10 for the detail about the input range.	R/W
(6)	+59	+136	Set Point (SP) Upper Limit/ Linear Conversion Maximum Value	When input is thermocouple/resistance thermometer: Set point (SP) lower limit to input range upper limit When input is voltage/current: Linear conversion minimum to input range upper limit	R/W

	Offset from the control register		Parameter	Description	R/W
	CH0	CH1			
(7)	+60	+137	Set Point (SP) Lower Limit/ Linear Conversion Minimum Value	When input is thermocouple/resistance thermometer: Input range lower limit to set point (SP) upper limit When input is voltage/current: Input range lower limit to linear conversion maximum	R/W
(8)	+62	+139	PV Correction	When input range unit is Celsius: -100.0 to 100.0°C When input range unit is Fahrenheit: -100.0 to 100.0°F When input is voltage/current: -1000 to 1000	R/W
(9)	+63	+140	PV Filter Time Constant	0.0 to 10.0 sec	R/W
(10)	+22 (Bit8)	+25 (Bit8)	External PV Mode	0: Disabled 1: Enabled	R/W
(11)	+65	+142	Alarm 1 Type	0: No alarm action 1: Upper limit alarm 2: Lower limit alarm 3: Upper/Lower limits alarm 4: Upper/Lower limit range alarm 5: Process high alarm 6: Process low alarm 7: Upper limit alarm with standby 8: Lower limit alarm with standby 9: Upper/Lower limits alarm with standby	R/W
	+66	+143	Alarm 2 Type		
	+67	+144	Alarm 3 Type		
	+68	+145	Alarm 4 Type		
	+69	+146	Alarm 5 Type		
	+70	+147	Alarm 6 Type		
	+71	+148	Alarm 7 Type		
+72	+149	Alarm 8 Type			
(12)	+37	+114	Alarm 1 Value	See page 6-10 for the detail about alarm value range.	R/W
	+38	+115	Alarm 2 Value		
	+39	+116	Alarm 3 Value		
	+40	+117	Alarm 4 Value		
	+41	+118	Alarm 5 Value		
	+42	+119	Alarm 6 Value		
	+43	+120	Alarm 7 Value		
+44	+121	Alarm 8 Value			
(13)	+73	+150	Alarm 1 Hysteresis	When the unit is Celsius: 0.1 to 100.0°C When the unit is Fahrenheit: 0.1 to 100.0°F When input is voltage/current: 1 to 1000	R/W
	+74	+151	Alarm 2 Hysteresis		
	+75	+152	Alarm 3 Hysteresis		
	+76	+153	Alarm 4 Hysteresis		
	+77	+154	Alarm 5 Hysteresis		
	+78	+155	Alarm 6 Hysteresis		
	+79	+156	Alarm 7 Hysteresis		
+80	+157	Alarm 8 Hysteresis			
(14)	+81	+158	Alarm 1 Delay Time	0 to 10000 sec	R/W
	+82	+159	Alarm 2 Delay Time		
	+83	+160	Alarm 3 Delay Time		
	+84	+161	Alarm 4 Delay Time		
	+85	+162	Alarm 5 Delay Time		
	+86	+163	Alarm 6 Delay Time		
	+87	+164	Alarm 7 Delay Time		
+88	+165	Alarm 8 Delay Time			

Input Range

Each input setting range is described.

Input Range		Range		Unit		
		PV	PV1/PV2	PV	PV1/PV2	
00h	Type K Thermocouple	Celsius	-200 to 1370°C	-200.0 to 1370.0°C	1°C	0.1°C
01h	Type K Thermocouple with Decimal Point		-200.0 to 400.0°C	-200.0 to 400.0°C	0.1°C	
02h	Type J Thermocouple		-200 to 1000°C	-200.0 to 1000.0°C	1°C	
03h	Type R Thermocouple		0 to 1760°C	0.0 to 1760.0°C	1°C	
04h	Type S Thermocouple		0 to 1760°C	0.0 to 1760.0°C	1°C	
05h	Type B Thermocouple		0 to 1820°C	0.0 to 1820.0°C	1°C	
06h	Type E Thermocouple		-200 to 800°C	-200.0 to 800.0°C	1°C	
07h	Type T Thermocouple		-200.0 to 400.0°C	-200.0 to 400.0°C	0.1°C	
08h	Type N Thermocouple		-200 to 1300°C	-200.0 to 1300.0°C	1°C	
09h	PL- II		0 to 1390°C	0.0 to 1390.0°C	1°C	
0Ah	C(W/Re5-26)		0 to 2315°C	0.0 to 2315.0°C	1°C	
0Bh	Pt100 with Decimal Point		-200.0 to 850.0°C	-200.0 to 850.0°C	0.1°C	
0Ch	JPt100 with Decimal Point		-200.0 to 500.0°C	-200.0 to 500.0°C	0.1°C	
0Dh	Pt100		-200 to 850°C	-200.0 to 850.0°C	1°C	
0Eh	JPt100		-200 to 500°C	-200.0 to 500.0°C	1°C	
0Fh	Type K Thermocouple		Fahrenheit	-328 to 2498°F	-328.0 to 2498.0°F	
10h	Type K Thermocouple with Decimal Point	-328.0 to 752.0°F		-328.0 to 752.0°F	0.1°F	
11h	Type J Thermocouple	-328 to 1832°F		-328.0 to 1832.0°F	1°F	
12h	Type R Thermocouple	32 to 3200°F		32.0 to 3200.0°F	1°F	
13h	Type S Thermocouple	32 to 3200°F		32.0 to 3200.0°F	1°F	
14h	Type B Thermocouple	32 to 3308°F		32.0 to 3308.0°F	1°F	
15h	Type E Thermocouple	-328 to 1472°F		-328.0 to 1472.0°F	1°F	
16h	Type T Thermocouple	-328.0 to 752.0°F		-328.0 to 752.0°F	0.1°F	
17h	Type N Thermocouple	-328 to 2372°F		-328.0 to 2372.0°F	1°F	
18h	PL- II	32 to 2534°F		32.0 to 2534.0°F	1°F	
19h	C(W/Re5-26)	32 to 4199°F		32.0 to 4199.0°F	1°F	
1Ah	Pt100 with Decimal Point	-328.0 to 1562.0°F		-328.0 to 1562.0°F	0.1°F	
1Bh	JPt100 with Decimal Point	-328.0 to 932.0°F		-328.0 to 932.0°F	0.1°F	
1Ch	Pt100	-328 to 1562°F		-328.0 to 1562.0°F	1°F	
1Dh	JPt100	-328 to 932°F		-328.0 to 932.0°F	1°F	
1Eh	4 to 20mA	-		-2000 to 10000(*1)	-2000 to 10000	1
1Fh	0 to 20mA					
20h	0 to 1V					
21h	0 to 5V					
22h	1 to 5V					
23h	0 to 10V					

(*1) Linear conversion is possible in the range of minimum linear conversion value to maximum linear conversion value.

Valid Range for Alarm 1 to Alarm 8 Value

The valid range of each alarm type is described in the following table.

Alarm Type	Valid Range
Upper Limit Alarm	–(Full scale) to full scale *1
Lower Limit Alarm	–(Full scale) to full scale *1
Upper/Lower Limits Alarm	0 to full scale *1
Upper/Lower Limit Range Alarm	0 to full scale *1
Process High Alarm	Input range lower limit to input range upper limit *2
Process Low Alarm	Input range lower limit to input range upper limit *2
Upper Limit Alarm with Standby	–(Full scale) to full scale *1
Lower Limit Alarm with Standby	–(Full scale) to full scale *1
Upper/Lower Limits Alarm with Standby	0 to full scale *1

*1: When input is voltage/current, full scale is the linear conversion span.

*2: When input is voltage/current, the valid range is the linear conversion minimum value to linear conversion maximum value.

Input Parameters List when External SP Input is Selected

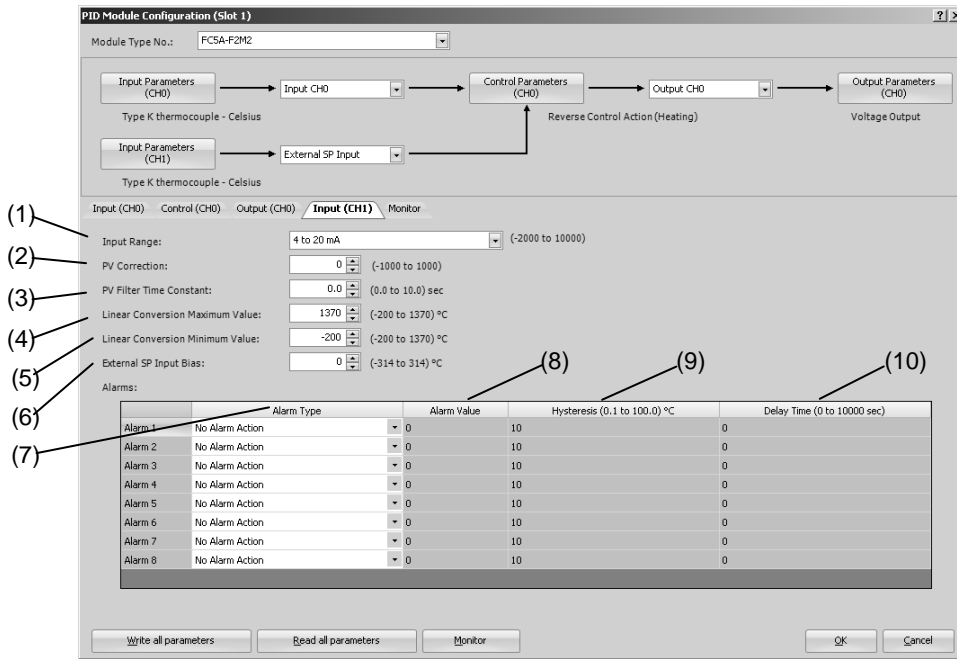

Control Registers

	Offset from the control register	Parameter	Description	R/W
(1)	+55	Input Range (External SP input)	0: Disabled (Note) 1: 4 to 20mA DC 2: 0 to 20mA DC 3: 1 to 5V DC 4: 0 to 1V DC 5: Cascade control (Note) Note: Disabled and Cascade control cannot be selected in the input range.	R/W
(2)	+139	PV Correction	-1000 to 1000	R/W
(3)	+140	PV Filter Time Constant	0.0 to 10.0 sec	R/W
(4)	+178	External SP Input Linear Conversion Maximum Value	External SP Input linear conversion min. to input range upper limit of CH0	R/W
(5)	+179	External SP Input Linear Conversion Minimum Value	Input range lower limit of CH0 to external SP input linear conversion max.	R/W
(6)	+177	External SP Input Bias	±20% of the external SP input linear conversion span	R/W
(7)	+142	Alarm 1 Type	0: No alarm action 1: No alarm action 2: No alarm action 3: No alarm action 4: No alarm action 5: Process high alarm 6: Process low alarm 7: No alarm action 8: No alarm action 9: No alarm action	R/W
	+143	Alarm 2 Type		
	+144	Alarm 3 Type		
	+145	Alarm 4 Type		
	+146	Alarm 5 Type		
	+147	Alarm 6 Type		
	+148	Alarm 7 Type		
+149	Alarm 8 Type			
(8)	+114	Alarm 1 Value		
	+115	Alarm 2 Value		
	+116	Alarm 3 Value		
	+117	Alarm 4 Value		
	+118	Alarm 5 Value		
	+119	Alarm 6 Value		
	+120	Alarm 7 Value		
+121	Alarm 8 Value			

(9)	+150	Alarm 1 Hysteresis	When input range unit is Celsius: 0.1 to 100.0°C When input range unit is Fahrenheit: 0.1 to 100.0°F When input is voltage or current: 1 to 1000	R/W
	+151	Alarm 2 Hysteresis		
	+152	Alarm 3 Hysteresis		
	+153	Alarm 4 Hysteresis		
	+154	Alarm 5 Hysteresis		
	+155	Alarm 6 Hysteresis		
	+156	Alarm 7 Hysteresis		
	+157	Alarm 8 Hysteresis		
(10)	+158	Alarm 1 Delay Time	0 to 10000 sec	R/W
	+159	Alarm 2 Delay Time		
	+160	Alarm 3 Delay Time		
	+161	Alarm 4 Delay Time		
	+162	Alarm 5 Delay Time		
	+163	Alarm 6 Delay Time		
	+164	Alarm 7 Delay Time		
	+165	Alarm 8 Delay Time		

PID Module Configuration - Control Parameters List (CH0 and CH1)

The control parameters for CH0 and CH1 are described here.

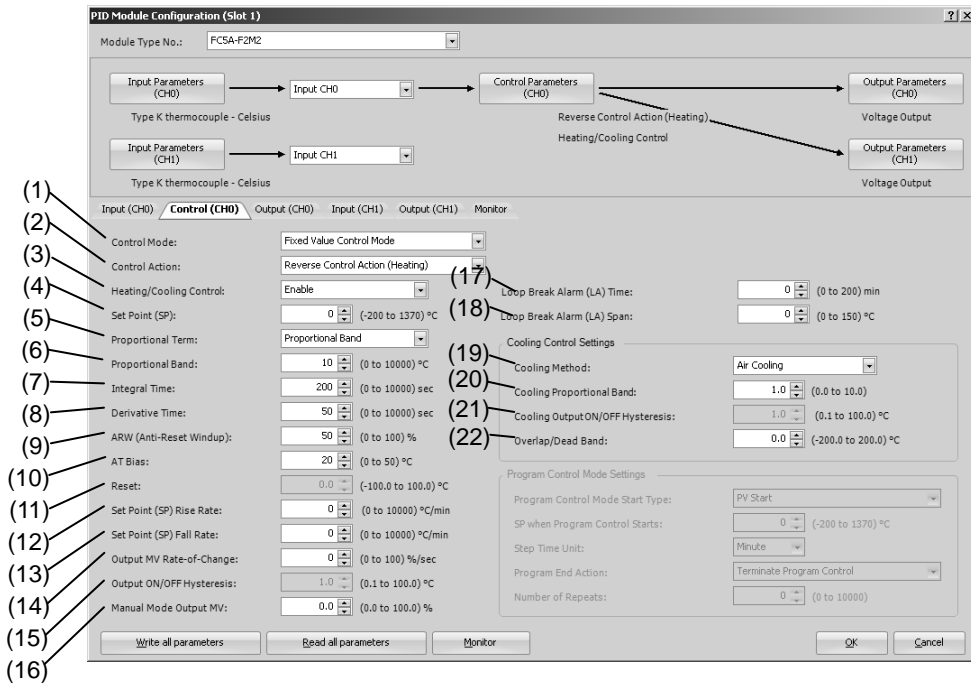

Control Parameters when Program Control Mode is Selected

When the program control mode is selected, parameters (23) to (27) are enabled. Parameters for the fixed value control mode, such as the set point (SP), proportional band/proportional gain, or integral time, are disabled.

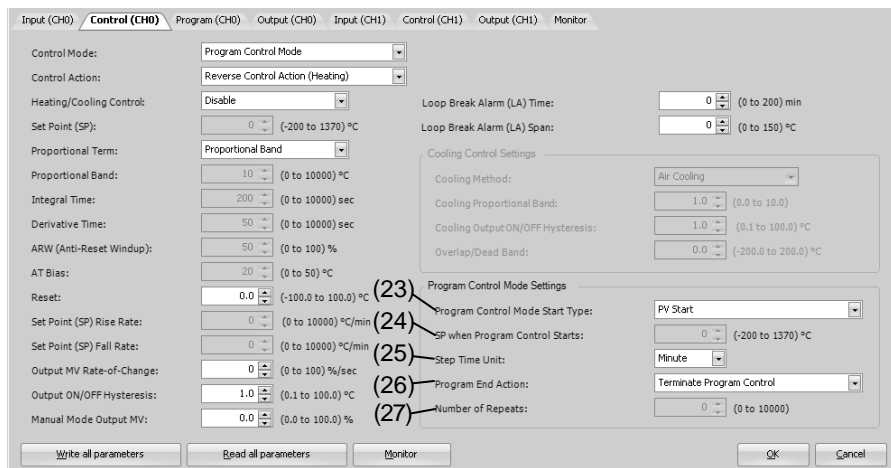

Control Registers

	Offset from the control register		Parameter	Description	R/W
	CH0	CH1			
(1)	+90	+167	Control Mode	0: Fixed value control mode 1: Program control mode When the cascade control is selected as Input CH1 Function, only the fixed value control mode can be selected for CH0 control. If program control is selected, external SP input will not work.	R/W
(2)	+53	+130	Control Action	0: Reverse control action (Heating) 1: Direct control action (Cooling)	R/W

	Offset from the control register		Parameter	Description	R/W
(3)	+54	–	Heating/Cooling Control	0: Disable 1: Enable	R/W
(4)	+20	+23	Set Point (SP)	When input is thermocouple/resistance thermometer: Set point (SP) lower limit to set point (SP) upper limit When input is voltage/current: Linear conversion min. to linear conversion max.	R/W
(5)	+94	+171	Proportional Term	0: Proportional band 1: Proportional gain	R/W
(6)	+26	+103	Proportional Band/ Proportional Gain	Proportional band: When input range unit is Celsius: 0 to 10000°C (Range with a decimal point: 0.0 to 1000.0°C) When input range unit is Fahrenheit: 0 to 10000°F (Range with a decimal point: 0.0 to 1000.0°F) When input is voltage/current: 0.0 to 1000.0% Proportional gain: 0.00 to 100.00%	R/W
(7)	+27	+104	Integral Time	0 to 10000 sec	R/W
(8)	+28	+105	Derivative Time	0 to 10000 sec	R/W
(9)	+29	+106	ARW (Anti-Reset Windup)	0 to 100%	R/W
(10)	+89	+166	AT Bias	When input range unit is Celsius: 0 to 50 °C (Range with a decimal point: 0.0 to 50.0 °C) When input range unit is Fahrenheit: 0 to 100 °F (Range with a decimal point: 0.0 to 100.0 °F)	R/W
(11)	+31	+108	Reset	When input range unit is Celsius: -100.0 to 100.0 °C When input range unit is Fahrenheit: -100.0 to 100.0 °F When input is voltage or current: -1000 to 1000	R/W
(12)	+33	+110	Set Point (SP) Rise Rate	When input range unit is Celsius: 0 to 10000°C/min (Range with a decimal point: 0.0 to 1000.0°C/min) When input range unit is Fahrenheit: 0 to 10000°F/min (Range with a decimal point: 0.0 to 1000.0°F/min) When input is voltage or current: 0 to 10000/min	R/W
(13)	+34	+111	Set Point (SP) Fall Rate	When input range unit is Celsius: 0 to 10000°C/min (Range with a decimal point: 0.0 to 1000.0°C/min) When input range unit is Fahrenheit: 0 to 10000°F/min (Range with a decimal point: 0.0 to 1000.0°F/min) When input is voltage or current: 0 to 10000/min	R/W

	Offset from the control register		Parameter	Setting Range	R/W
	CH0	CH1			
(14)	+32	+109	Output Manipulated Variable Rate-of-Change	0 to 100%/sec	R/W
(15)	+61	+138	Output ON/OFF Hysteresis	When input range unit is Celsius: 0.1 to 100.0°C When input range unit is Fahrenheit: 0.1 to 100.0°F When input is voltage or current: 1 to 1000	R/W
(16)	+21	+24	Manual Mode Output Manipulated Variable	When heating/cooling control is disabled: Output manipulated variable lower limit to output manipulated variable upper limit When heating/cooling control is enabled: - Cooling output manipulated variable upper limit to heating output manipulated variable upper limit	R/W
(17)	+35	+112	Loop Break Alarm (LA) Time	0 to 200 minutes	R/W
(18)	+36	+113	Loop Break Alarm (LA) Span	When input range unit is Celsius: 0 to 150 °C (Range with a decimal point: 0.0 to 150.0°C) When input range unit is Fahrenheit: 0 to 150 °F (Range with a decimal point: 0.0 to 150.0°F) When input is voltage or current: 0 to 1500	R/W
(19)	+95	-	Cooling Method	0: Air cooling 1: Oil cooling 2: Water cooling	R/W
(20)	+48	-	Cooling Proportional Band	0.0 to 10.0 times (Cooling proportional band is the product of this value and the heating proportional band)	R/W
(21)	+98	-	Cooling Output ON/OFF Hysteresis	When input range unit is Celsius: 0.1 to 100.0°C When input range unit is Fahrenheit: 0.1 to 100.0°F When input is voltage or current: 1 to 1000	R/W
(22)	+50	-	Overlap/Dead Band	When input range unit is Celsius: -200.0 to 200.0°C When input range unit is Fahrenheit: -200.0 to 200.0°F When input is voltage or current: -2000 to 2000	R/W
(23)	+91	+168	Program Control Mode Start Type	0: PV start 1: PVR start 2: SP start	R/W
(24)	+96	+173	Set Point (SP) when Program Control Starts	When input is thermocouple/resistance thermometer: Set point (SP) lower limit to set point (SP) upper limit When input is voltage or current: Linear conversion min. to linear conversion max.	R/W
(25)	+92	+169	Step Time Unit	0: Minute 1: Second	R/W
(26)	+93	+170	Program End Action	0: Terminate program control 1: Continue program control (Repeat) 2: Hold program control	R/W
(27)	+97	+174	Number of Repeats	0 to 10000 times	R/W

Control Parameters when Cascade Control is Enabled

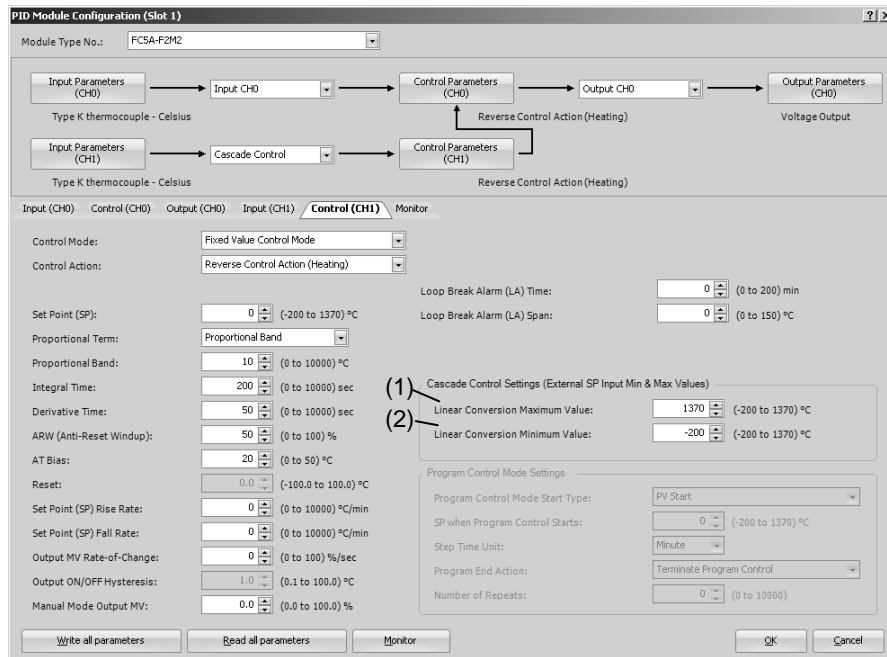

Control Registers

	Offset from the control register		Parameter	Setting Range	R/W
	CH0	CH1			
(1)	-	+178	External SP Input Linear Conversion Maximum Value	External SP Input linear conversion min. value to input range upper limit of CH0	R/W
(2)	-	+179	External SP Input Linear Conversion Minimum Value	Input range lower limit of CH0 to external SP Input linear conversion max. value	R/W

When Input CH0 External PV Mode and Input CH1 External PV Mode are Enabled

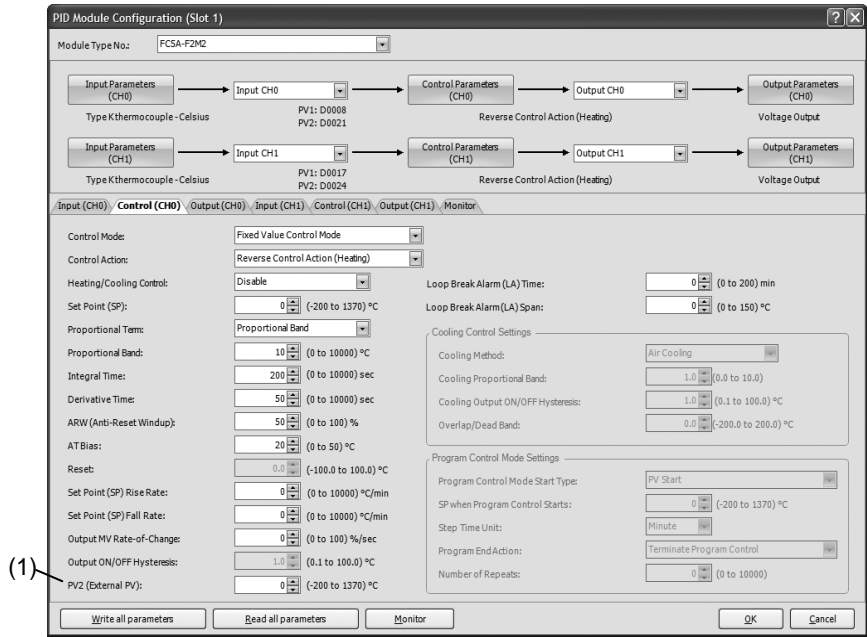

Control Registers

	Offset from the control register		Parameter	Setting Range	R/W
	CH0	CH1			
(1)	+21	+24	External PV Mode Process Variable (PV2)	When input is thermocouple/resistance thermometer: Minimum input value to maximum input value (°C/ °F) When input is voltage or current: Minimum linear conversion value to maximum linear conversion value	R/W

PID Module Configuration - Output Parameters List (CH0 and CH1)

The output parameters for CH0 and CH1 are described here.

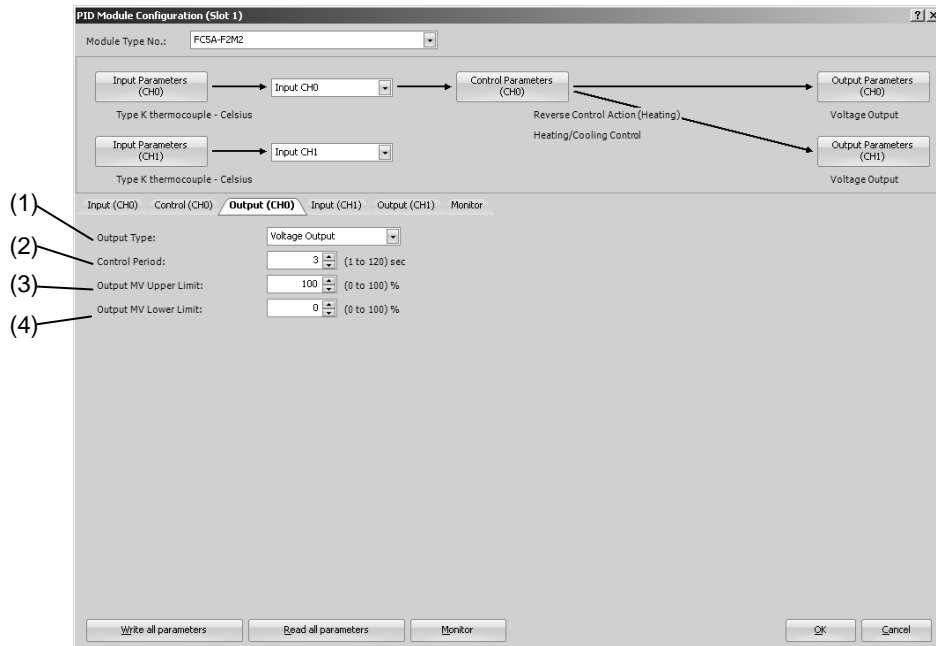

Output Parameters when Heating/Cooling Control is Enabled

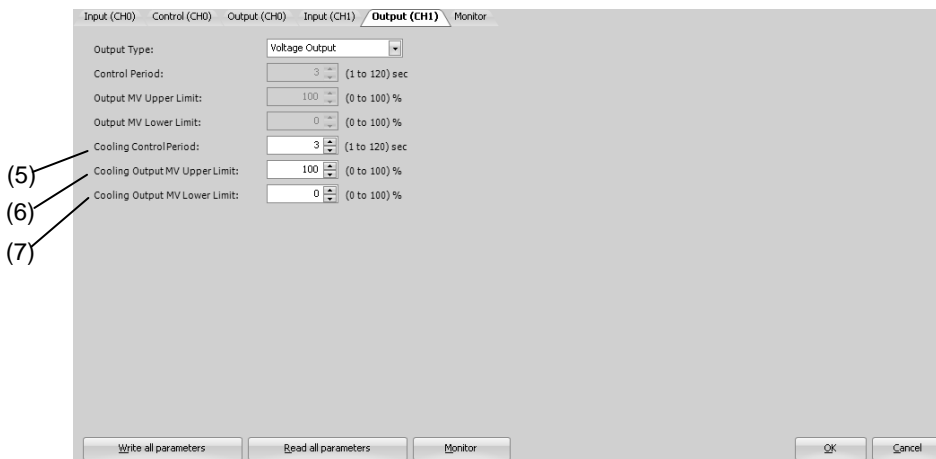

Control Registers

	Offset from the control register		Parameter	Description	R/W
	CH0	CH1			
(1)	+99	+176	Output Type	0: Non-contact voltage output (for SSR drive) 1: Current output	R/W
(2)	+30	+107	Control Period	1 to 120 sec	R/W
(3)	+46	+123	Output Manipulated Variable Upper Limit	When output type is voltage: Output manipulated variable lower limit to 100% When output type is current: Output manipulated variable lower limit to 105%	R/W
(4)	+47	+124	Output Manipulated Variable Lower Limit	When output type is voltage: 0% to output manipulated variable upper limit When output type is current: -5% to output manipulated variable upper limit	R/W
(5)	+49	-	Cooling Control Period	1 to 120 sec	R/W

	Offset from the control register		Parameter	Description	R/W
	CH0	CH1			
(6)	+51	–	Cooling Output Manipulated Variable Upper Limit	When output type is voltage: Cooling output manipulated variable lower limit to 100% When output type is current: Cooling output manipulated variable lower limit to 105%	R/W
(7)	+52	–	Cooling Output Manipulated Variable Lower Limit	When output type is voltage: 0% to cooling output manipulated variable upper limit When output type is current: -5% to cooling output manipulated variable upper limit	R/W

PID Module Configuration - Program Parameters List (CH0 and CH1)

Program parameters for CH0 and CH1 are described here.

Input (CH0)	Control (CH0)	Program (CH0)	Output (CH0)	Input (CH1)	Output (CH1)	Monitor						
		Range	Step 0	Step 1	Step 2	Step 3	Step 4	Step 5	Step 6	Step 7	Step 8	Step 9
		Set Point (SP) (-200 to 1370) °C	0	0	0	0	0	0	0	0	0	0
		Step Time (0 to 6000) min	0	0	0	0	0	0	0	0	0	0
		Wait Value (0 to 100) °C	0	0	0	0	0	0	0	0	0	0
		Proportional Band (0 to 10000) °C	10	10	10	10	10	10	10	10	10	10
		Integral Time (0 to 10000) sec	200	200	200	200	200	200	200	200	200	200
		Derivative Time (0 to 10000) sec	50	50	50	50	50	50	50	50	50	50
		ARW (Anti-Reset Windup) (0 to 100) %	50	50	50	50	50	50	50	50	50	50
		Output MV Rate-of-Change (0 to 100) %/sec	0	0	0	0	0	0	0	0	0	0
		Alarm 1 Value (-1570 to 1570) °C	0	0	0	0	0	0	0	0	0	0
		Alarm 2 Value (-1570 to 1570) °C	0	0	0	0	0	0	0	0	0	0
		Alarm 3 Value (-1570 to 1570) °C	0	0	0	0	0	0	0	0	0	0
		Alarm 4 Value (-1570 to 1570) °C	0	0	0	0	0	0	0	0	0	0
		Alarm 5 Value (-1570 to 1570) °C	0	0	0	0	0	0	0	0	0	0
		Alarm 6 Value (-1570 to 1570) °C	0	0	0	0	0	0	0	0	0	0
		Alarm 7 Value (-1570 to 1570) °C	0	0	0	0	0	0	0	0	0	0
		Alarm 8 Value (-1570 to 1570) °C	0	0	0	0	0	0	0	0	0	0
		Output MV Upper Limit (0 to 100) %	100	100	100	100	100	100	100	100	100	100
		Output MV Lower Limit (0 to 100) %	0	0	0	0	0	0	0	0	0	0
		Cooling Proportional Band (0.0 to 10.0) times	1	1	1	1	1	1	1	1	1	1
		Overlap/Dead Band (-200.0 to 200.0) °C	0	0	0	0	0	0	0	0	0	0

Control Registers

	Offset from the control register		Parameter	Description	R/W
	CH0	CH1			
(1)	+180	+390	Set Point (SP)	When input is thermocouple/resistance thermometer: Set point (SP) lower limit to set point (SP) upper limit When input is voltage or current: Linear conversion min. to linear conversion max.	R/W
(2)	+181	+391	Step Time	When step time unit is Minute: 0 to 6000 minutes When step time unit is Second: 0 to 6000 seconds	R/W
(3)	+182	+392	Wait Value	When input range unit is Celsius: 0 to 100°C (Range with a decimal point: 0.0 to 100.0°C) When input range unit is Fahrenheit: 0 to 100°F (Range with a decimal point: 0.0 to 100.0°F) When input is voltage or current: 0 to 1000	R/W
(4)	+183	+393	Proportional Band/ Proportional Gain	Proportional band: When input range unit is Celsius: 0 to 10000°C (Range with a decimal point: 0.0 to 1000.0°C) When input range unit is Fahrenheit: 0 to 10000°F (Range with a decimal point: 0.0 to 1000.0°F) When input is voltage or current: 0.0 to 1000.0% Proportional gain: 0.00 to 100.00%	R/W
(5)	+184	+394	Integral Time	0 to 10000 sec	R/W
(6)	+185	+395	Derivative Time	0 to 10000 sec	R/W

	Offset from the control register		Parameter	Description	R/W
	CH0	CH1			
(7)	+186	+396	ARW (Anti-Reset Windup)	0 to 100%	R/W
(8)	+187	+397	Output Manipulated Variable Rate-of-Change	0 to 100%/sec	R/W
(9)	+188	+398	Alarm 1 Value	Refer to the valid range for alarm 1 to alarm 8 values shown in the following table.	R/W
(10)	+189	+399	Alarm 2 Value		
(11)	+190	+400	Alarm 3 Value		
(12)	+191	+401	Alarm 4 Value		
(13)	+192	+402	Alarm 5 Value		
(14)	+193	+403	Alarm 6 Value		
(15)	+194	+404	Alarm 7 Value		
(16)	+195	+405	Alarm 8 Value		
(17)	+197	+407	Output Manipulated Variable Upper Limit	When output type is voltage: Output manipulated variable lower limit to 100% When output type is current: Output manipulated variable lower limit to 105%	R/W
(18)	+198	+408	Output Manipulated Variable Lower Limit	When output type is voltage: 0% to output manipulated variable upper limit When output type is current: -5% to output manipulated variable upper limit	R/W
(19)	+199	-	Cooling Proportional Band	0.0 to 10.0 times (Cooling proportional band is the multiplication of heating proportional band)	R/W
(20)	+200	-	Overlap/Dead Band	When input range unit is Celsius: -200.0 to 200.0°C When input range unit is Fahrenheit: -200.0 to 200.0°F When input is voltage or current: -2000 to 2000	R/W

Valid Range for Alarm 1 to Alarm 8 Value

Alarm Type	Valid Range
Upper Limit Alarm	-(Full scale) to full scale *1
Lower Limit Alarm	-(Full scale) to full scale *1
Upper/Lower Limits Alarm	0 to full scale *1
Upper/Lower Limit Range Alarm	0 to full scale *1
Process High Alarm	Input range lower limit to input range upper limit *2
Process Low Alarm	Input range lower limit to input range upper limit *2
Upper Limit Alarm with Standby	-(Full scale) to full scale *1
Lower Limit Alarm with Standby	-(Full scale) to full scale *1
Upper/Lower Limits Alarm with Standby	0 to full scale *1

*1: When input is voltage/current, full scale is the linear conversion span.

*2: When input is voltage/current, the valid range is the linear conversion minimum value to linear conversion maximum value.

PID Module Configuration - I/O Function Selections

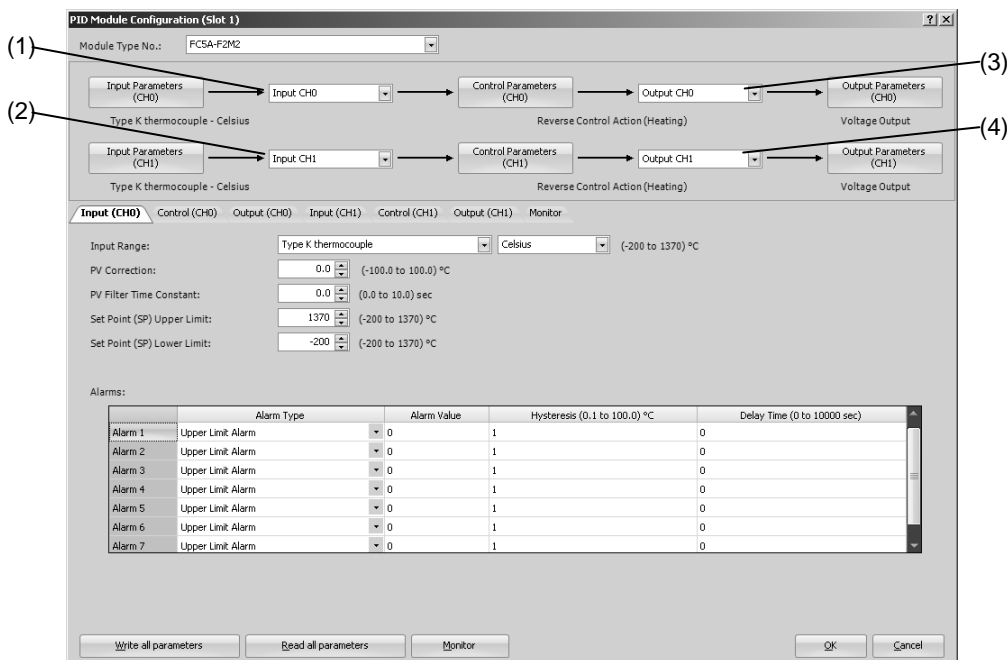

(1) Control Register+56: Input CH0 Function

The one of the following input functions can be selected as the Input CH0 Function.

Input CH0:

Input CH0 is used as the process variable (PV) for CH0 control.

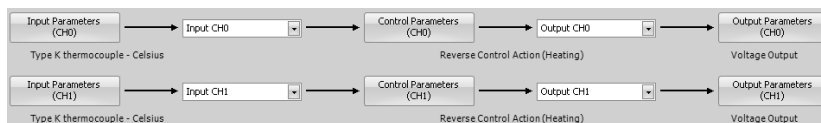

Difference (CH0-CH1):

The difference between input CH0 and input CH1 is used as the process variable (PV) for CH0 control. Process variable (PV) of CH0 control = Input CH0 input value - Input CH1 input value

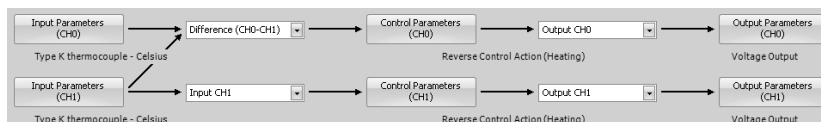

Difference (CH1-CH0):

The difference between input CH1 and input CH0 is used as the process variable (PV) for CH0 control. Process variable (PV) of CH0 control = Input CH1 input value - Input CH0 input value

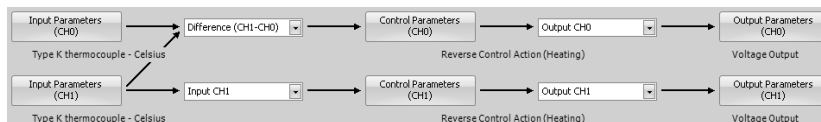

Addition (CH0+CH1):

The addition of input CH0 and input CH1 is used as the process variable (PV) for CH0 control. Process variable (PV) of CH0 control = Input CH0 input value + Input CH1 input value

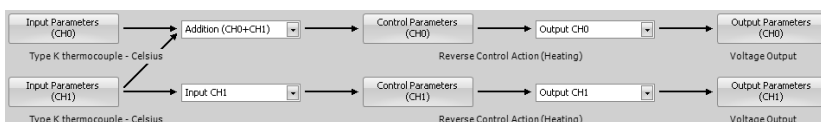

(2) Control Register+133: Input CH1 Function
Control Register+55: External SP Input

The one of the following input functions can be selected as the Input CH1 Function.

Input CH1:

Input CH1 is used as the process variable (PV) for CH1 control.

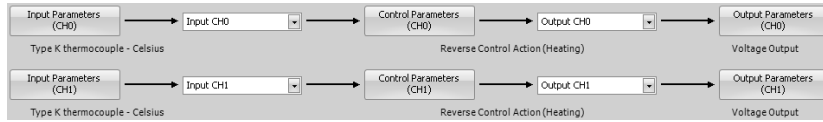

Difference (CH0-CH1):

The difference between input CH0 and input CH1 is used as the process variable (PV) for CH1 control. Process variable (PV) of CH1 control = Input CH0 input value - Input CH1 input value

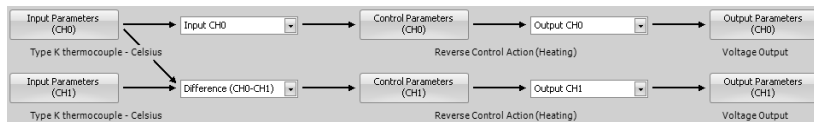

Difference (CH1-CH0):

The difference between input CH1 and input CH0 is used as the process variable (PV) for CH1 control. Process variable (PV) of CH1 control = Input CH1 input value - Input CH0 input value

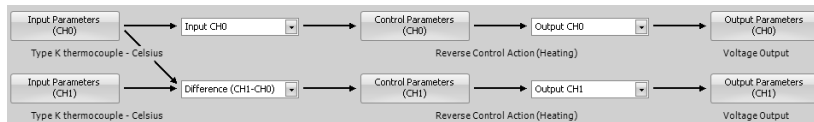

Addition (CH0+CH1):

The addition of input CH0 and input CH1 is used as the process variable (PV) for CH1 control. Process variable (PV) of CH1 control = Input CH0 input value + Input CH1 input value

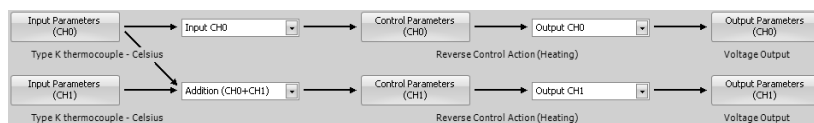

External SP Input:

Input CH1 is used as the set point (SP) for CH0 control.

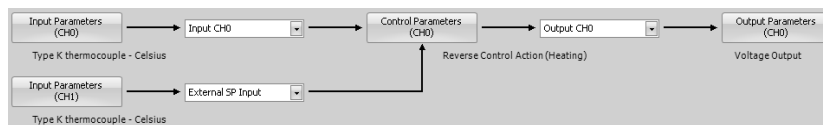

When the external SP input bias is configured, the external SP input bias is added to the input CH1 value, and then the input CH1 value is used as the set point (SP) for CH0 control. One of the analog input types shown in the table below can be selected for the external SP input.

	Current	Voltage
Input Type	4 to 20mA DC or 0 to 20mA DC	1 to 5V DC or 0 to 1V DC
Allowable Input	50mA DC maximum	0 to 1V DC: 5V DC maximum 1 to 5V DC: 10V DC maximum
Input Impedance	50Ω	100kΩ

Cascade Control:

The cascade control is an advanced control that uses 2 inputs [CH1 as a master (primary control) and CH0 as a slave (secondary control)] to control a single process.

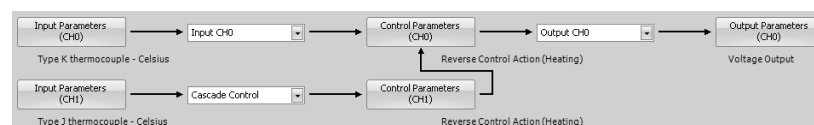

Master (CH1) calculates the output manipulated variable (MV) according to the process variable (PV) and the set point (SP). The output manipulated variable (MV) of the master (CH1) is used as the set point (SP) of the slave (CH0). With the obtained set point (SP), the slave (CH0) calculates the output manipulated variable (MV) and controls the output CH0.

When the cascade control is used, the output CH1 is unused. When the output type is current, the output CH1 is 4 mA. When the output type is voltage, the output CH1 is 0 V. When the output type is relay, Output CH1 is turned off. When heating/cooling control is enabled, output CH1 is used as the cooling output.

Output manipulated variable (MV) (0 to 100%) of the master (CH1) is converted using the external SP input linear conversion minimum and maximum values and is used as the set point (SP) of the slave (CH0).

Example: When the external SP input linear conversion minimum value is 0°C and the external SP input linear conversion maximum value is 1000°C, the set point (SP) of the slave (CH0) is decided as follows:

When master (CH1) output manipulated variable (MV) is 0%: 0°C

When master (CH1) output manipulated variable (MV) is 50%: 500°C

When master (CH1) output manipulated variable (MV) is 100%: 1000°C

Combination of Input CH0 and Input CH1 Functions

The possible combinations of Input CH0 and CH1 Functions are shown below. (O: Possible, X: Impossible)

Input CH0 \ Input CH1	Input CH1					
	Input CH1	Difference (CH0-CH1)	Difference (CH1-CH0)	Addition (CH0+CH1)	External SP Input	Cascade Control
Input CH0	O	O	O	O	O	O
Difference (CH0-CH1)	O	O	O	O	X	X
Difference (CH1-CH0)	O	O	O	O	X	X
Addition (CH0+CH1)	O	O	O	O	X	X

(3) Control Register+57: Output CH0 Function

The one of the following output functions can be selected as the Output CH0 Function.

Output (CH0): The output of the CH0 control is outputted from output CH0

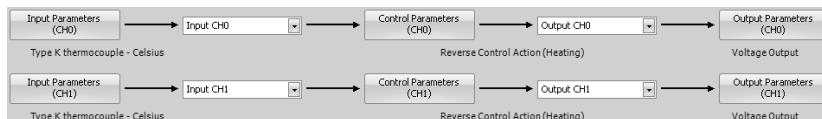

Output (CH1): The output of the CH0 control is outputted from output CH1

When Output (CH1) is selected, CH1 parameters are used for the control period and the output manipulated variable (MV) upper and lower limits. CH0 parameters are used for all other parameters, such as the output manipulated variable rate-of-change, output on/off hysteresis, and manual mode output manipulated variable.

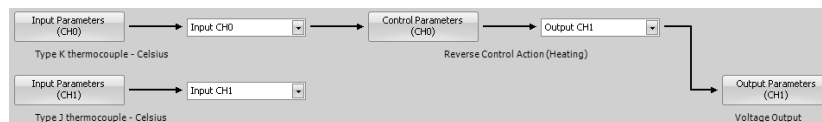

When Output (CH1) is selected, output CH0 is unused. When output type is relay, the output CH0 is turned off. When output type is voltage/current, output CH0 is 0V/4mA.

Both Outputs (CH0, CH1): The output of the CH0 control is outputted from both outputs CH0 and CH1. The control period and output manipulated variable (MV) upper and lower limits of CH0 and CH1 are used for the corresponding output. CH0 parameters are used for all other parameters, such as, the output manipulated variable rate-of-change, output on/off hysteresis, and manual mode output manipulated variable.

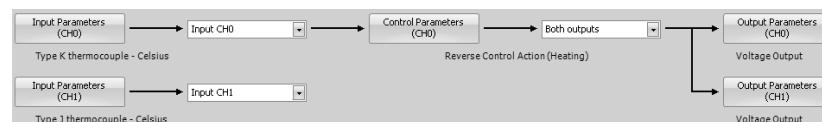

(4) Control Register+134: Output CH1 Function

Output (CH1) is always selected as Output CH1 Function. The output of the CH1 control is outputted from output CH1. Output CH0 Function has priority.

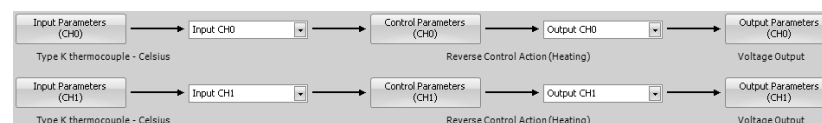

PID Module Configuration - Input Parameters Details

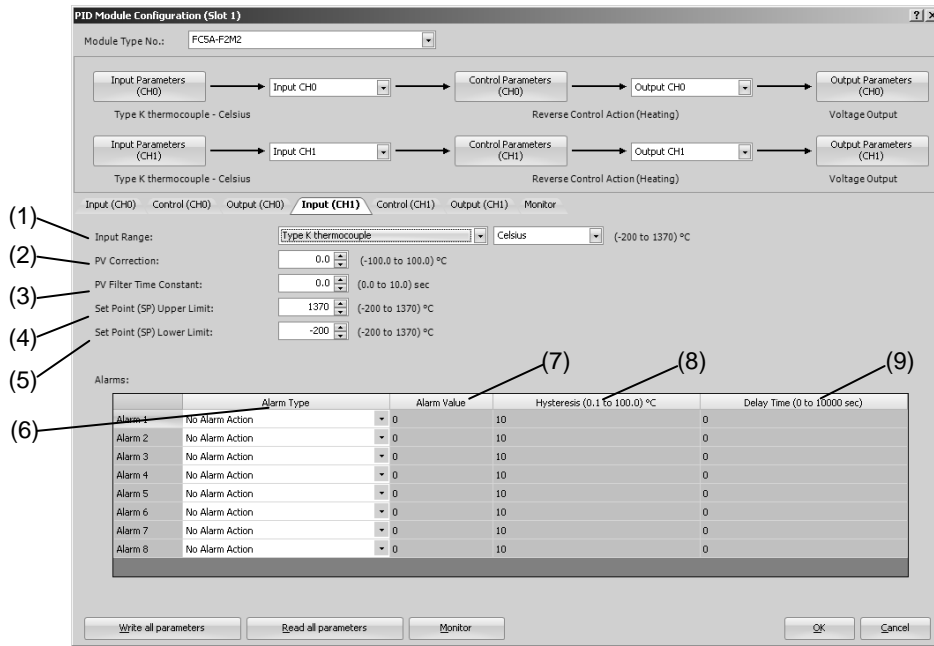

Input parameters for CH0 control are described here. Input parameters for CH1 control are the same as those of CH0 control. However, the position from the control register for each parameter differs. For details about the positions from the control register for CH1 control, see 5-17 to 5-20.

(1) Control Register+58: Input Range

Select input type and input range unit (Celsius or Fahrenheit). For details about the input range, see 6-10.

(2) Control Register+62: PV Correction

If the sensor cannot be installed to the location of the control target, the temperature measured by the sensor may deviate from the actual temperature of the control target. When a target is controlled with multiple PID modules, the measured temperatures may not match due to the differences in sensor accuracy or dispersion of load capacities even though the set points (SP) of those PID modules are the same. In such cases, the process variable (PV) of the PID module can be adjusted to the desired temperature by using the PV Correction. The process variable (PV) after the PV correction should be within the control range (See 9-4). For example, when type K thermocouple (-200 to 1370°C) is selected as input type, configure an appropriate PV correction value so that the process variable (PV) after the PV correction does not exceed the control range (-250 to 1420°C) [(Input range lower limit - 50°C) to (Input range upper limit + 50°C)].

When the process variable (PV) after the PV correction is within the control range, the PID module controls the temperature based on the process variable (PV) after the PV correction. When the process variable (PV) after the PV correction is out of the control range, the under or over range error occurs and the control output is turned off

The process variable (PV) after the PV correction can be calculated using the following formula:
 Process variable (PV) after the PV correction = Process variable (PV) + (PV correction value)

Example 1: When process variable (PV) is 198°C

If the PV correction value is 2.0°C, the process variable (PV) will be 200.0°C (198°C + 2.0°C).

If the PV correction value is -2.0°C, the Process variable (PV) will be 196.0°C (198°C - 2.0°C).

Example 2: By setting the PV correction value for the PID module to 10.0°C, the process variable (PV) of the PID module is adjusted from 190°C to 200°C.

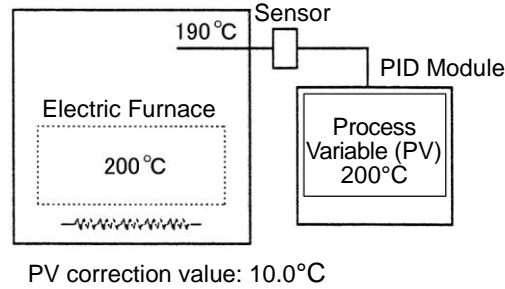

(3) Control Register +63: PV Filter Time Constant

The PV filter function is a software filter to stabilize the process variable (PV) affected by fluctuating processes, such as the pressure or flow rate, by calculating first-order lag of the process variable (PV). Even if the process variable (PV) changes as shown in the Figure 1, when the PV filter time constant is configured, the process variable (PV) changes as shown in the Figure 2. After the PV filtering process, the process variable (PV) reaches 63% of the process variable (PV) in T seconds.

If the PV filter time constant is too large, it adversely affects the control results due to the delay of response.

Example: If the least significant digit of the process variable (PV) is fluctuating, the fluctuation can be suppressed by using the PV filter time constant.

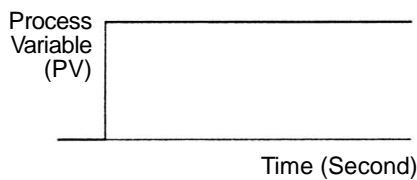

Figure 1. Process variable (PV) before PV filtering process

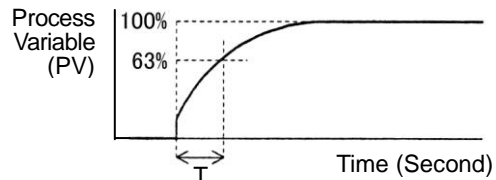

Figure 2. Process variable (PV) after PV filtering process

(4) Control Register+59: Set Point (SP) Upper Limit/Linear Conversion Maximum Value

(5) Control Register+60: Set Point (SP) Lower Limit/Linear Conversion Minimum Value

Linear Conversion Function

The diagram below shows an example of the linear conversion. When the linear conversion maximum value is 5000 and the linear conversion minimum value is 0, the current input (4 to 20mA DC) is linearly-converted as shown in the diagram.

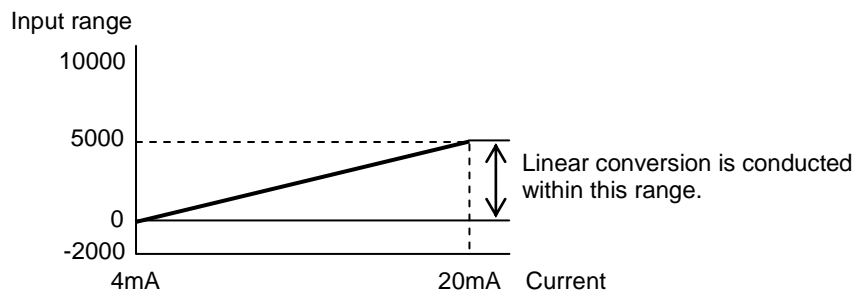

Set Point (SP) Upper Limit/Linear Conversion Maximum Value

When input type is thermocouple or resistance thermometer, the linear conversion is disabled. The linear conversion maximum value is used as the upper limit of the set point (SP). When input type is voltage/current, configure the maximum value of input CH0 as the linear conversion maximum value. Any value within the valid input range can be configured.

Set Point (SP) Lower Limit/Linear Conversion Minimum Value

When input type is thermocouple or resistance thermometer, the linear conversion is disabled. The linear conversion minimum value is used as the lower limit of the set point (SP). When input type is voltage/current, configure the minimum value of input CH0 as the linear conversion minimum value. Any value within the valid range can be configured.

- (6) Control Register+65: Alarm 1 Type
- Control Register+66: Alarm 2 Type
- Control Register+67: Alarm 3 Type
- Control Register+68: Alarm 4 Type
- Control Register+69: Alarm 5 Type
- Control Register+70: Alarm 6 Type
- Control Register+71: Alarm 7 Type
- Control Register+72: Alarm 8 Type

Select one of the alarm types from upper limit alarm, lower limit alarm, upper/lower limits alarm, upper/lower limit range alarm, process high alarm, process low alarm, upper limit alarm with standby, lower limit alarm with standby, upper/lower limits alarm with standby, and no alarm action. The same alarm type can be selected in multiple alarms.

Alarm Actions

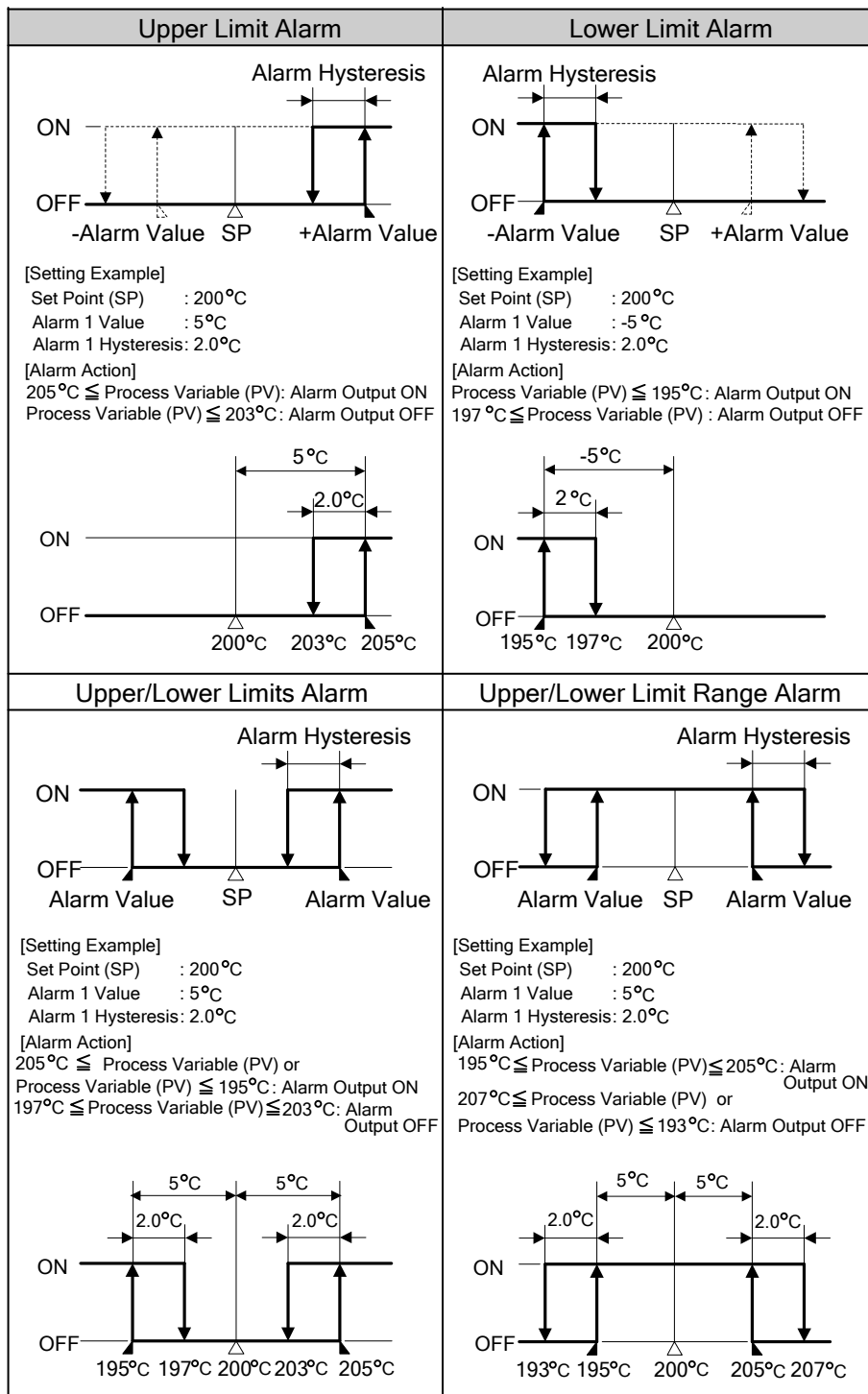

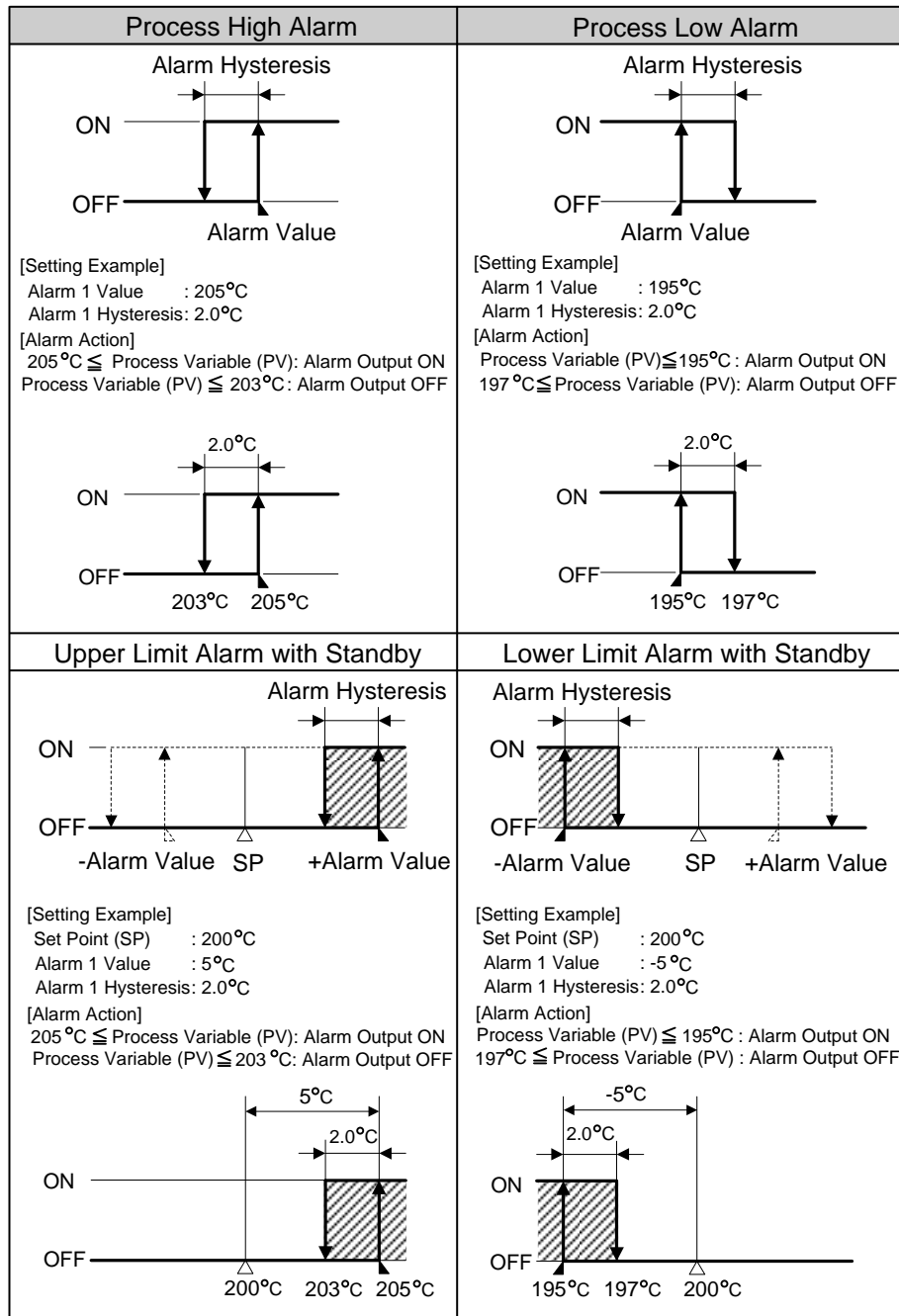

 : Standby functions.

Note: When the set point (SP) is changed, the standby function is enabled. Once the process variable (PV) enters the alarm output off range, the standby function is canceled.

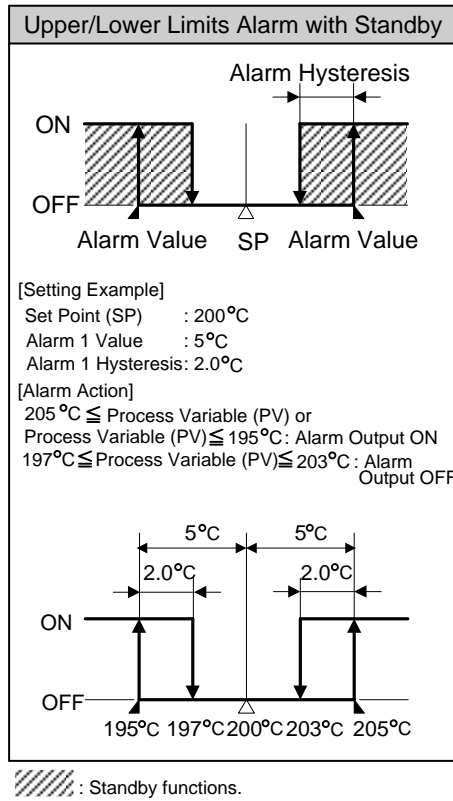

Notes:

- When the set point (SP) is changed, the standby function is enabled. Once the process variable (PV) enters the alarm output off range, the standby function is canceled.
- Even when an alarm output is triggered, the PID module continues its control. To stop the control when an alarm is triggered, ladder programming is needed. For a ladder program example, see 7-6.

- (7) **Control Register+37: Alarm 1 Value**
- Control Register+38: Alarm 2 Value**
- Control Register+39: Alarm 3 Value**
- Control Register+40: Alarm 4 Value**
- Control Register+41: Alarm 5 Value**
- Control Register+42: Alarm 6 Value**
- Control Register+43: Alarm 7 Value**
- Control Register+44: Alarm 8 Value**

There are two types of alarms: Deviation alarm and process alarm.

	Alarm Type	Alarm Value	Alarm Action
Deviation Alarm	Upper/Lower limit range alarm	Deviation from the set point (SP) is the alarm value.	The alarm output turns off if the process variable (PV) exceeds the range.
	Upper limit alarm, Lower limit alarm, Upper/Lower limits alarm, Upper limit alarm with standby, Lower limit alarm with standby, Upper/Lower limits alarm with standby		The alarm output turns on if the process variable (PV) exceeds the range.
Process Alarm	Process high alarm Process low alarm	The alarm action point is the alarm value.	The alarm output turns on if the process variable (PV) exceeds the alarm value.

When the alarm value is 0, the alarm action is disabled except process high alarm and process low alarm. If the input type or input unit type is changed, confirm the valid range of the alarm value and configure appropriate values.

- (8) Control Register+73: Alarm 1 Hysteresis**
- Control Register+74: Alarm 2 Hysteresis**
- Control Register+75: Alarm 3 Hysteresis**
- Control Register+76: Alarm 4 Hysteresis**
- Control Register+77: Alarm 5 Hysteresis**
- Control Register+78: Alarm 6 Hysteresis**
- Control Register+79: Alarm 7 Hysteresis**
- Control Register+80: Alarm 8 Hysteresis**

When an alarm turns from on to off and vice versa, the span between on and off is called alarm hysteresis. If the alarm hysteresis is narrowed, the alarm output switches to on or off even by a slight variation of temperature at around the alarm action point. This frequent on/off of an alarm may negatively affect the connected equipment. To prevent that harmful effect, configure the alarm hysteresis for alarm on/off action.

- (9) Control Register+81: Alarm 1 Delay Time**
- Control Register+82: Alarm 2 Delay Time**
- Control Register+83: Alarm 3 Delay Time**
- Control Register+84: Alarm 4 Delay Time**
- Control Register+85: Alarm 5 Delay Time**
- Control Register+86: Alarm 6 Delay Time**
- Control Register+87: Alarm 7 Delay Time**
- Control Register+88: Alarm 8 Delay Time**

The alarm is not triggered until the configured time elapses after the process variable (PV) enters the alarm output range. The input fluctuation due to noise may result in alarm output turning on. This can be prevented by configuring the alarm delay time. When an alarm output is changed from on to off status, the alarm output turns off and the alarm action delay time is reset. When the alarm output is changed from off to on status, the time counting starts.

Input Parameters when External SP Input is Selected

The input CH1 parameters when External SP input is selected as the Input CH1 Function are described here.

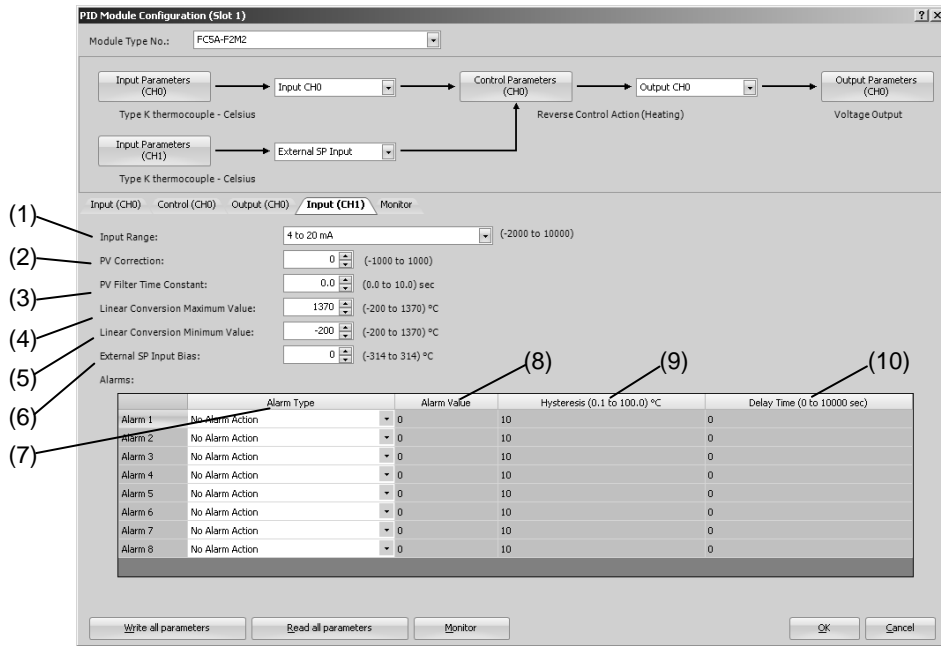

(1) Control Register+55: Input Range

Select input type for the external SP input. Current (4 to 20mA DC or 0 to 20mA DC) or voltage (0 to 1V DC or 1 to 5V DC) can be selected.

(2) Control Register+62: PV Correction

If the sensor cannot be installed to the location of the control target, the temperature measured by the sensor may deviate from the actual temperature of the control target. When a target is controlled with multiple PID modules, the measured temperatures may not match due to the differences in sensor accuracy or dispersion of load capacities even though the set points (SP) of those PID modules are the same. In such cases, the process variable (PV) of the PID module can be adjusted to the desired temperature by using the PV Correction.

The process variable (PV) after PV correction can be calculated using the following formula.

$$\text{Process variable (PV) after PV correction} = \text{Process variable (PV)} + (\text{PV correction value})$$

(3) Control Register +63: PV Filter Time Constant

The PV filter function is a software filter to stabilize the process variable (PV) affected by fluctuating processes such as pressure or flow rate by calculating first-order lag of the process variable (PV). Even if the process variable (PV) changes as shown in the Figure 1, when the PV filter time constant is configured, the process variable (PV) changes as shown in the Figure 2. After the PV filtering process, the process variable (PV) reaches 63% of the process variable (PV) in T seconds.

If the PV filter time constant is too large, it adversely affects the control results due to the delay of response.

Example: If the least significant digit of the process variable (PV) is fluctuating, the fluctuation can be suppressed by using the PV filter time constant.

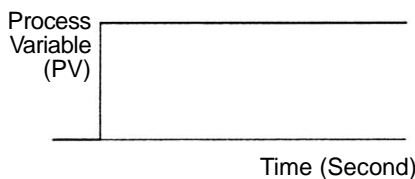

Figure 1. Process variable (PV) before PV filtering process

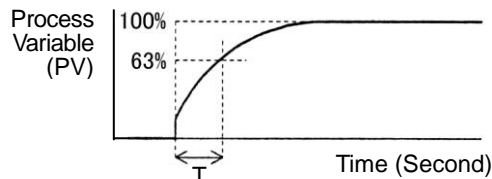

Figure 2. Process variable (PV) after PV filtering process

(4) Control Register+178: External SP Input Linear Conversion Maximum Value

Configure the linear conversion maximum value for the external SP input. When input type is current (4 to 20mA DC or 0 to 20mA DC), configure the value corresponding to 20mA for input CH1. When input type is voltage (0 to 1V DC or 1 to 5V DC), configure the value corresponding to 1V or 5V for input CH1.

Example: When input type is current (4 to 20mA DC), if the external SP input linear conversion maximum value is 1000°C, external SP input 20mA corresponds to the set point (SP) 1000°C for CH0 control. When input type is voltage (0 to 1V DC), if external SP input linear conversion maximum value is 1200°C, external SP input 1V corresponds to the set point (SP) 1200°C for CH0 control.

(5) Control Register+179: External SP Input Linear Conversion Minimum Value

Configure the linear conversion minimum value for the external SP input. When input type is current (4 to 20mA DC or 0 to 20mA DC), configure the value corresponding to 4mA or 0mA for input CH1. When input type is voltage (0 to 1V DC or 1 to 5V DC), configure the value corresponding to 0V or 1V for input CH1.

Example: When input type is current (4 to 20mA DC), if external SP input linear conversion minimum value is 0°C, external SP input 4mA corresponds to the set point (SP) 0°C for CH0 control. When input type is voltage (0 to 1V DC), if external SP input linear conversion maximum value is set to -20°C, external SP input 0V corresponds to the set point (SP) -20°C for CH0 control.

(6) Control Register+177: External SP Input Bias

The external SP input bias is added to the set point (SP) obtained after the linear conversion for the external SP input. The set point (SP) is then used as the set point (SP) for CH0 control.

Examples:

When the input type is current (4 to 20mA DC), the linear conversion maximum value is 1000°C, the linear conversion minimum value is 0°C, and the external SP input bias is 50°C, the set point (SP) of CH0 control corresponding to 12mA of external SP input will be 550°C.

When the input type is voltage (0 to 1V DC), the linear conversion maximum value is 1000°C, the linear conversion minimum value is 0°C, and the external SP input bias is 50°C, the set point (SP) of CH0 control corresponding to 0.5V of external SP input will be 550°C.

- (7) Control Register+65: Alarm 1 Type
- Control Register+66: Alarm 2 Type
- Control Register+67: Alarm 3 Type
- Control Register+68: Alarm 4 Type
- Control Register+69: Alarm 5 Type
- Control Register+70: Alarm 6 Type
- Control Register+71: Alarm 7 Type
- Control Register+72: Alarm 8 Type

Select one of the alarm types from process high alarm, process low alarm, and no alarm action. The same alarm type can be selected in multiple alarms.

Alarm Actions

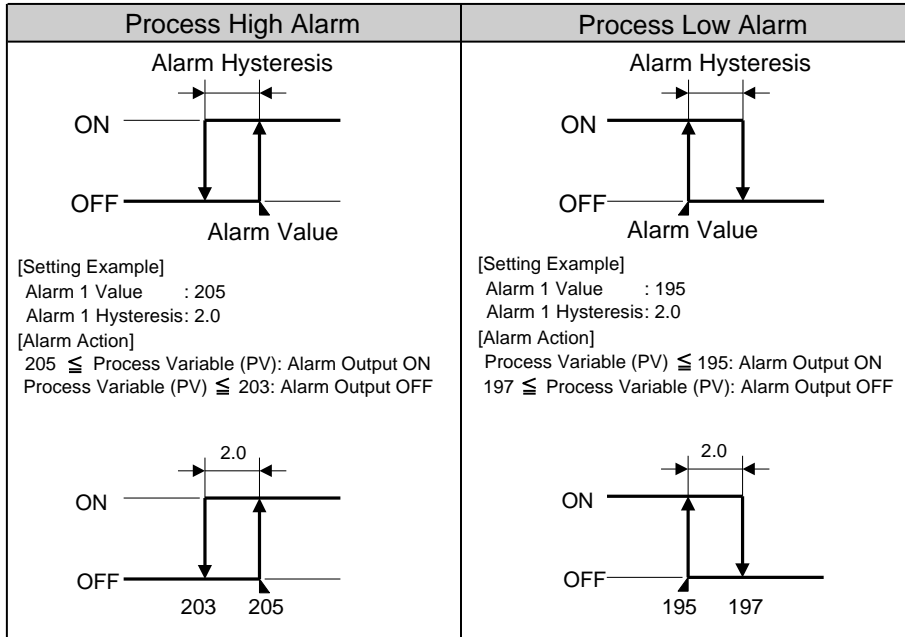

- (8) Control Register+37: Alarm 1 Value
- Control Register+38: Alarm 2 Value
- Control Register+39: Alarm 3 Value
- Control Register+40: Alarm 4 Value
- Control Register+41: Alarm 5 Value
- Control Register+42: Alarm 6 Value
- Control Register+43: Alarm 7 Value
- Control Register+44: Alarm 8 Value

	Alarm Type	Alarm Value	Alarm Action
Process Alarm	Process high alarm Process low alarm	The alarm action point is the alarm value.	The alarm output turns on if the process variable (PV) exceeds the alarm value.

- (9) Control Register+73: Alarm 1 Hysteresis**
- Control Register+74: Alarm 2 Hysteresis**
- Control Register+75: Alarm 3 Hysteresis**
- Control Register+76: Alarm 4 Hysteresis**
- Control Register+77: Alarm 5 Hysteresis**
- Control Register+78: Alarm 6 Hysteresis**
- Control Register+79: Alarm 7 Hysteresis**
- Control Register+80: Alarm 8 Hysteresis**

When an alarm turns from on to off and vice versa, the span between on and off is called alarm hysteresis. If the alarm hysteresis is narrowed, the alarm output switches to on or off even by a slight variation of temperature at around the alarm action point. This frequent on/off of an alarm may negatively affect the connected equipment. To prevent that harmful effect, configure the alarm hysteresis for alarm on/off action.

- (10) Control Register+81: Alarm 1 Action Delay Time**
- Control Register+82: Alarm 2 Action Delay Time**
- Control Register+83: Alarm 3 Action Delay Time**
- Control Register+84: Alarm 4 Action Delay Time**
- Control Register+85: Alarm 5 Action Delay Time**
- Control Register+86: Alarm 6 Action Delay Time**
- Control Register+87: Alarm 7 Action Delay Time**
- Control Register+88: Alarm 8 Action Delay Time**

The alarm is not triggered until the configured time elapses after the process variable (PV) enters the alarm output range. The input fluctuation due to noise may result in alarm output turning on. This can be prevented by configuring the alarm delay time. When an alarm output is changed from on to off status, the alarm output turns off and the alarm action delay time is reset. When the alarm output is changed from off to on status, the time counting starts.

PID Module Configuration - Control Parameters Details

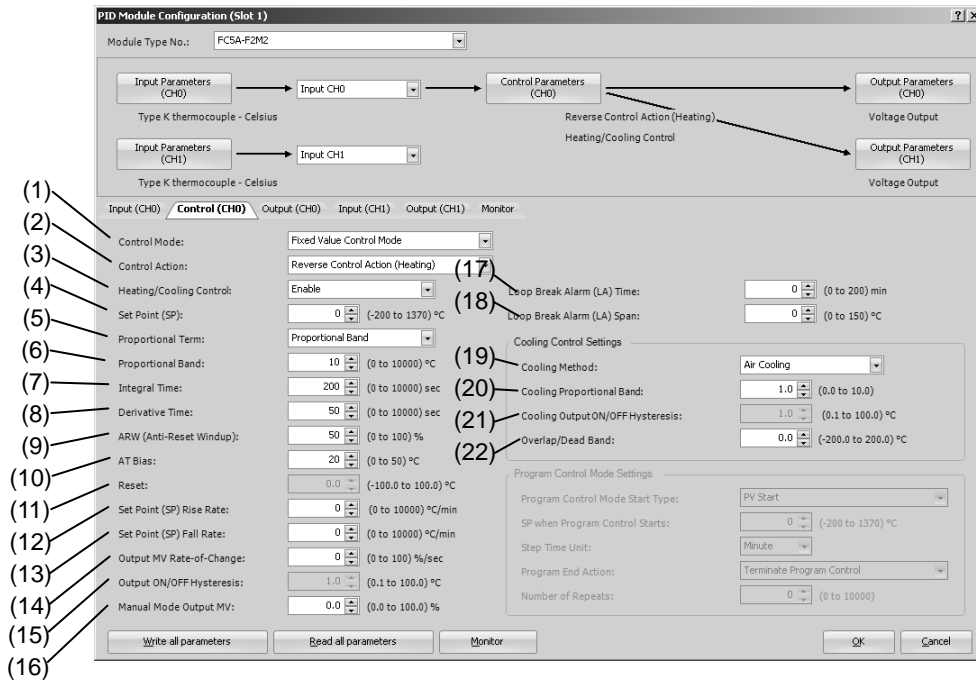

Control Parameters when Program Control Mode Is Selected

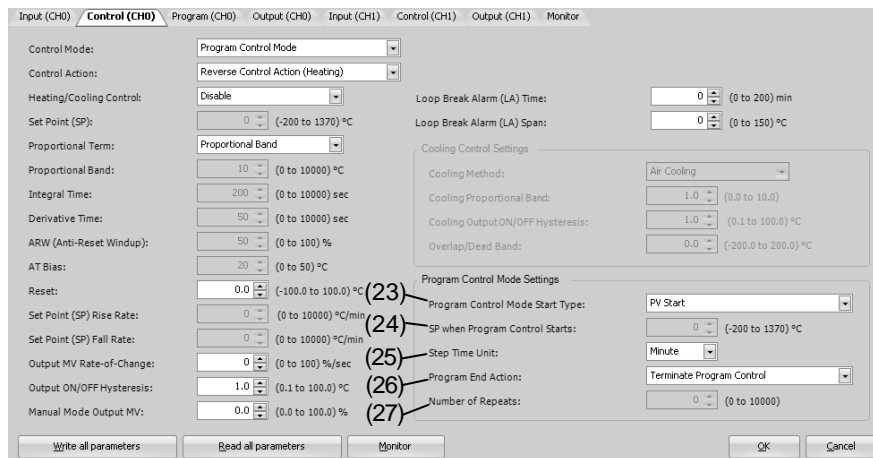

Control parameters of CH0 control are described here. When the program control mode is selected as the control mode, parameters for the fixed value control mode, such as the set point (SP), proportional band/proportional gain, or integral time, are disabled. The parameters for the program control mode (23) to (27) are enabled.

Control parameters for CH1 control are the same as those of CH0 control except cascade control parameters. However, the position from the control register for each parameter differs. For details about the positions from the control register for CH1 control, see pages 5-17 to 5-20.

(1) Control Register+90: Control Mode

Either fixed value control mode or program control mode can be selected. When the external SP input or the cascade control is selected in Input CH1 Function, the program control mode cannot be used for CH0 control. Select fixed value control mode for control mode of CH0 control. If the program control mode is selected, the external SP input does not function.

The fixed value control is a normal temperature control that the PID module controls the output to eliminate the deviation between a single set point (SP) and the process variable (PV). The following diagram shows an example of the fixed value control.

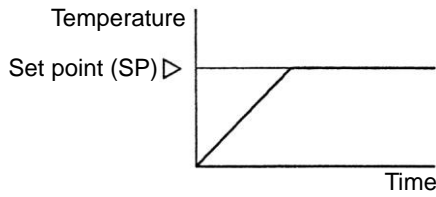

The program control allows you to define the set point (SP) that changes as the time progresses so that the process variable (PV) can be controlled to match the set point (SP) changing as the time progresses. The set point (SP) and time can be configured for each step. A maximum of 10 steps can be configured and performed. The set point (SP) can be configured as shown in the following diagram.

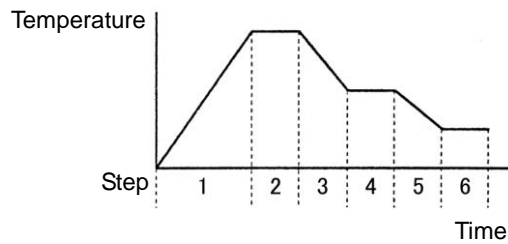

(2) Control Register+53: Control Action

Selects either direct control action or reverse control action.

In direct control action, the output manipulated variable (MV) increases when the process variable (PV) is higher than the set point (SP) (positive deviation). For example, freezers perform the direct control (cooling) action.

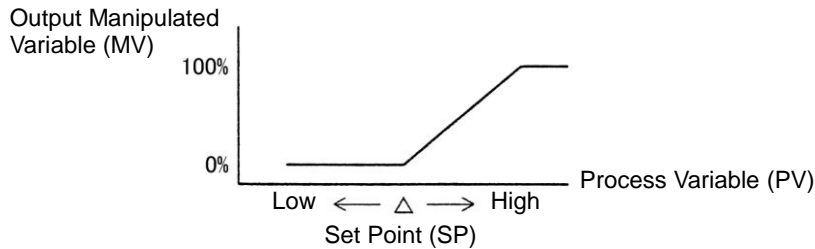

In reverse control action, the output manipulated variable (MV) increases when the process variable (PV) is lower than the set point (SP) (negative deviation). For example, electric furnaces perform the reverse control (heating) action.

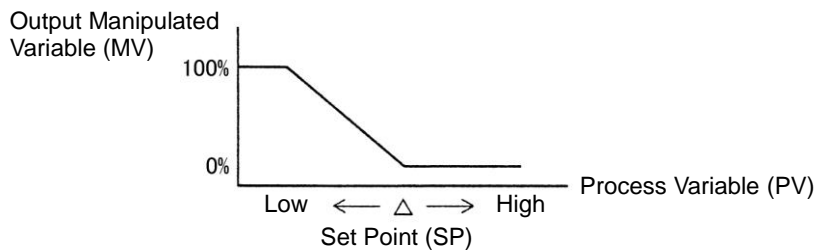

(3) Control Register+54: Heating/Cooling Control

The heating/cooling control can be enabled. When it is difficult to control a target process with heating control only, cooling control can be added to perform the heating/cooling control.

Example: Heating/Cooling control uses both heating and cooling outputs and is suitable for the heat producing processes such as extruders or for temperature control at near the ambient temperature, such as environment testers.

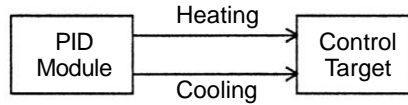

(4) Control Register+20: Set point (SP)

Any value within the following valid range can be configured as the set point (SP).

The valid range of set point (SP) when the input type is thermocouple or resistance thermometer:

$$\text{Set point (SP) lower limit} \leq \text{Set point (SP)} \leq \text{Set point (SP) upper limit}$$

The valid range of set point (SP) when the input type is voltage or current:

$$\text{Linear conversion minimum value} \leq \text{Set point (SP)} \leq \text{Linear conversion maximum value}$$

If the input type or input unit type is changed, confirm the valid range of set point (SP) and configure an appropriate value.

(5) Control Register+94: Proportional Term

Either proportional band or proportional gain can be selected to use. The proportional band, which is expressed in percentage form (%), is the span of the input necessary for the output manipulated variable (MV) to change from 0% to 100%. The proportional gain is the coefficient to calculate the output manipulated variable (MV) of the proportional action. The proportional gain can be obtained as the quotient of 100 and the proportional band.

Example: When the proportional band is 50%, the corresponding proportional gain will be 2% (100/50).

(6) Control Register+26: Proportional Band/Proportional Gain

The output of the proportional action varies in proportion to the deviation between the set point (SP) and the process variable (PV). When the heating/cooling control is enabled, this parameter becomes the heating proportional band. The control action will be ON/OFF control when the proportional band/proportional gain is 0. If the proportional band is broadened (proportional gain is made smaller), the control output starts turning on or off at the significantly low temperatures from the set point (SP), overshoot or hunting is reduced; however, it takes time for the process variable (PV) to reach the set point (SP), and the offset between the process variable (PV) and the set point (SP) is broadened.

If the proportional band is narrowed (proportional gain is made larger), the control output starts turning on or off at around the set point (SP), the time until the process variable (PV) reaches the set point (SP) is shortened, and the offset is small; however, the hunting phenomenon is frequent. If the proportional band is greatly narrowed, the control action becomes similar to the ON/OFF control action.

An appropriate proportional band/proportional gain for the control target can be automatically calculated using auto-tuning (AT) function. It is unnecessary to configure the proportional band/proportional gain in the WindLDR when using the auto-tuning (AT) function.

(7) Control Register+27: Integral Time

In the proportional control action, the offset is generated even when the control is stabilized. The integral action corrects the offset. The integral action is disabled when the integral time is 0.

The integral time is a coefficient to determine the output manipulated variable (MV) of the integral action.

If the integral time is shortened too much, the integral action becomes strong. The offset can be corrected in a shorter time; however, the hunting phenomenon may be caused over a long cycle. On the contrary, if the integral time is extended too much, the integral action becomes weak and it takes time to correct the offset.

An appropriate integral time for the control target can be automatically calculated using auto-tuning (AT) function. It is unnecessary to configure the integral time in the WindLDR when using the auto-tuning (AT) function.

(8) Control Register+28: Derivative Time

When the set point (SP) is changed or when the deviation between the set point (SP) and the process variable (PV) is increased due to a disturbance, the derivative action increases the output manipulated variable (MV) to rapidly correct the deviation between the process variable (PV) and the set point (SP). The derivative time is a coefficient to determine the output manipulated variable (MV) of the derivative action. The derivative action is disabled when the derivative time is 0.

If the derivative time is shortened, the derivative action becomes weak. The response to the rapid temperature change becomes slower. Because the action to suppress the rapid temperature rise becomes weaker, the time for the process variable (PV) to reach the set point (SP) is shortened; however, overshoot can occur.

If the derivative time is extended, the derivative action becomes strong. The response to the rapid temperature change becomes faster. Because the action to suppress the rapid temperature rise becomes strong, the time for the process variable (PV) to reach the set point (SP) is extended; however, overshoot can be decreased.

An appropriate derivative time for the control target can be automatically calculated using auto-tuning (AT) function. It is unnecessary to configure the derivative time in the WindLDR when using the auto-tuning (AT) function.

(9) Control Register+29: ARW (Anti-Reset Windup)

When the control is started, there is a large deviation between the set point (SP) and the process variable (PV). The integral action continues its action in a given direction until the process variable (PV) reaches the set point (SP). As a result, an overshoot is caused by the excessive integral action. ARW suppresses the overshoot by limiting the integral action area.

When ARW is 0%, the integral action area becomes the minimum and the suppression of the overshoot is maximized. When ARW is 50%, the integral action area becomes the intermediate and the suppression of the overshoot is intermediate. When ARW is 100%, the integral action area becomes the maximum and the suppression of the overshoot is minimized.

An appropriate ARW for the control target can be automatically calculated using auto-tuning (AT) function. It is unnecessary to configure the ARW in the WindLDR when using the auto-tuning (AT) function.

(10) Control Register+89: AT Bias

Auto-tuning (AT) starting point can be specified with the AT bias.

When Process variable (PV) \leq Set point (SP) – AT bias:

AT starting point = Set point (SP) – AT bias

When Process variable (PV) \geq Set point (SP) + AT bias:

AT starting point = Set point (SP) + AT bias

When Set point (SP) – AT bias < Process variable (PV) < Set point (SP) + AT bias:

AT starting point = Set point (SP)

For details about the AT bias, see page 4-6.

(11) Control Register+31: Reset

The reset corrects the offset between the set point (SP) and the process variable (PV) generated in P or PD control action. Reset can be configured only in P (integral time and derivative time are 0) or PD (integral time is 0) control action.

P or PD control action is used for the control target in which overshoot caused by the integral action is hard to be suppressed.

When the reverse control action is selected, the manipulated variable is calculated with the ratio of the reset to the proportional band, and the calculated manipulated variable is added to the output manipulated variable (MV). When the direct control action is selected, the manipulated variable is calculated with the ratio of the reset to the proportional band, and the calculated manipulated variable is subtracted from the output manipulated variable (MV).

(12) Control Register+33: Set Point (SP) Rise Rate

(13) Control Register+34: Set Point (SP) Fall Rate

When the set point (SP) is widely changed, this function makes the set point (SP) change gradually. The rising/falling span of the set point (SP) in 1 minute can be configured.

When the set point (SP) is changed, the set point (SP) is gradually changed from the original set point (SP) to the new set point (SP) with the configured ratio (°C/minute, °F/minute). When the control is started, the set point (SP) is gradually changed from the process variable (PV) to the set point (SP) with the configured ratio (°C/minute, °F/minute). In the fixed value control mode, this function is used to configure the desired temperature gradient until the process variable (PV) reaches the set point (SP).

This function is disabled when the set point (SP) rise/fall rate is 0.

(14) Control Register+32: Output Manipulated Variable Rate-of-Change

The maximum change of the output manipulated variable in one second can be configured. This function is disabled when the value is 0.

In the case of heating control, when there is a large deviation between the process variable (PV) and the set point (SP), the output immediately changes from off to on as shown in the diagram below (Normal Output). By configuring the output manipulated variable rate-of-change, the maximum change of the output manipulated variable (MV) in one second can be changed as shown in the diagram below (Output When Output Manipulated Variable Rate-of-Change is Configured).

This function can be used for a high temperature heater (used at approximately 1500 to 1800°C) which has to be heated gradually, as the heater can be burnt out if the power is supplied rapidly.

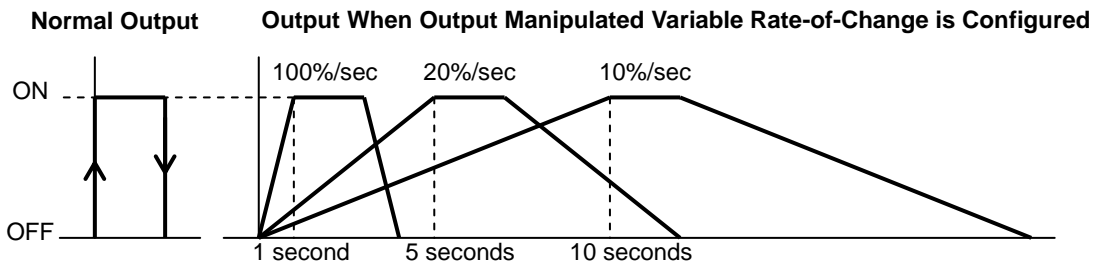

(15) Control Register+61: Output ON/OFF Hysteresis

Output on/off hysteresis can be configured. When the control action turns from on to off and vice versa, the span between on and off positions is called output on/off hysteresis.

If the output on/off hysteresis is narrowed, the control output switches to on or off even by a slight variation of temperature at around the set point (SP). This frequent on/off shortens the output relay life and may negatively affect the connected equipment. To prevent that harmful effect, the hysteresis is provided for on/off control action.

Output on/off hysteresis can be configured only for the ON/OFF control action (when the proportional band or proportional gain is 0).

(16) Control Register+21: Manual Mode Output Manipulated Variable

The output manipulated variable (MV) for the manual mode can be configured.

(17) Control Register+35: Loop Break Alarm Time

Configure the loop break alarm time to detect the loop break alarm. The loop break alarm is disabled when the loop break alarm time is 0. When one of the following conditions is met, the PID module considers that heater burnout, sensor burnout, or actuator trouble is detected and triggers the loop break alarm.

When the reverse control action is selected:

- The loop break alarm is triggered when the process variable (PV) does not rise as much as the loop break alarm span within the loop break alarm time while the output manipulated variable (MV) is 100% or the output manipulated variable upper limit.
- The loop break alarm is also triggered when the process variable (PV) does not fall as much as the loop break alarm span within the loop break alarm time while the output manipulated variable (MV) is 0% or the output manipulated variable lower limit.

When the direct control action is selected:

- The loop break alarm is triggered when the process variable (PV) does not fall as much as the loop break alarm span within the loop break alarm time while the output manipulated variable (MV) is 100% or the output manipulated variable upper limit.
- The loop break alarm is also triggered when the process variable (PV) does not rise as much as the loop break alarm span within the loop break alarm time while the output manipulated variable (MV) is 0% or the output manipulated variable lower limit value.

Even when the loop break alarm is triggered, the PID module continues its control. To stop the control, ladder programming is needed.

Ladder Program Example

The control register is D1000 in this example.

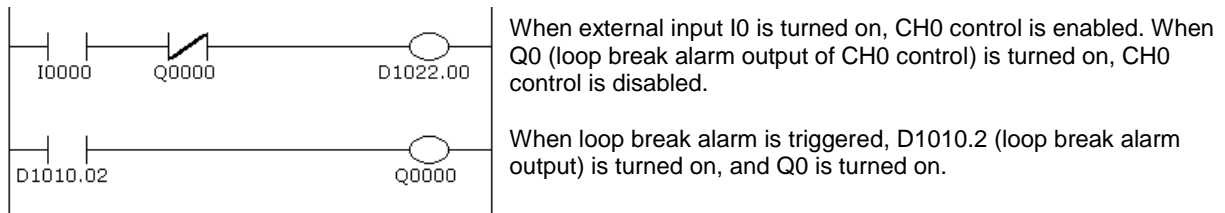

(18) Control Register+36: Loop Break Alarm Span

Configure the loop break alarm span to detect the loop break alarm. The loop break alarm is disabled when the loop break alarm span is 0.

(19) Control Register+95: Cooling Method

When the heating/cooling control is enabled, select the cooling method from air cooling, oil cooling, or water cooling. The output characteristics for the cooling output manipulated variable (MV) are shown below.

- Air cooling: linear characteristic
- Oil cooling: 1.5th power of the linear characteristic
- Water cooling: 2nd power of the linear characteristic

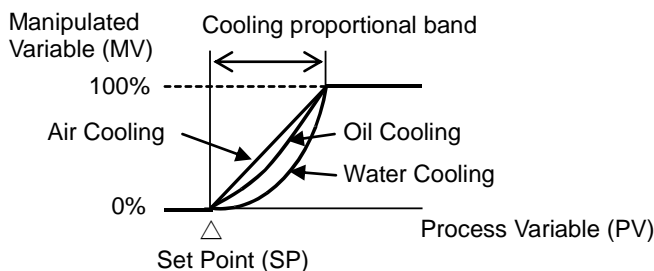

Output Characteristics of Cooling Method

(20) Control Register+48: Cooling Proportional Band

The cooling proportional band can be configured when the heating/cooling control is enabled. The cooling proportional band is the multiplication of the heating proportional band.

Example:

When the heating proportional band is 10°C and the cooling proportional band is 2.0, the cooling proportional band will be 20°C. If cooling proportional band value is 0.5, the cooling proportional band will be 5°C.

If the cooling proportional band is 0, the cooling side control will be ON/OFF control action. If the heating proportional band is 0, both heating and cooling side controls will be ON/OFF control action.

(21) Control Register+98: Cooling Output ON/OFF Hysteresis

Output on/off hysteresis for cooling output can be configured. When cooling control action turns from on to off and vice versa, the span between on and off positions of the cooling output is called cooling output on/off hysteresis.

If the cooling output on/off hysteresis is narrowed, the cooling control output switches to on or off even by a slight variation of temperature at around the set point (SP). This frequent on/off shortens the output relay life and may negatively affect the connected equipment. To prevent that harmful effect, the hysteresis is provided for on/off control action.

Cooling output on/off hysteresis can be configured only when cooling control action is in ON/OFF control (when cooling proportional band is 0).

(22) Control Register+50: Overlap/Dead Band

The overlap/dead band of the heating and cooling outputs can be configured when heating/cooling control is enabled. When the configured value is bigger than 0, the value is used as the dead band. When the configured value is less than 0, the value is used as overlap band.

When the overlap band is configured, the area in which both heating and cooling control outputs are turned on is generated, and the energy loss is caused. However, the overlap helps enhance the control accuracy and accelerate the response.

When the dead band is configured, the area in which neither heating nor cooling control outputs are turned on is generated. In the dead band, the control accuracy and responsiveness is lowered; however, the energy loss can be suppressed.

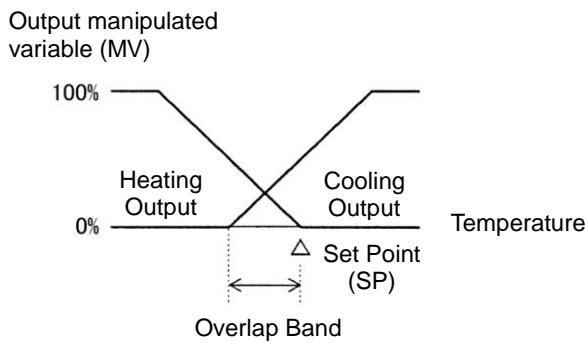

Overlap Band Action

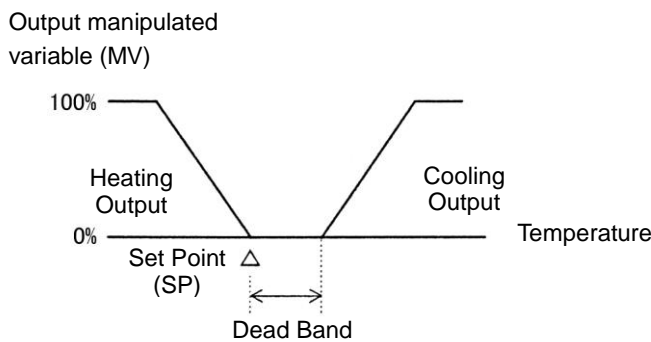

Dead Band Action

(23) Control Register+91: Program Control Mode Start Type

Select the program control mode start type from the following:

PV Start	When the program control is started, the time is advanced until the set point (SP) becomes equal to the process variable (PV), and then the program control starts.
PVR Start	When "Continue program control (Repeat)" is selected as the program end action, the time is advanced until the set point (SP) becomes equal to the process variable (PV) at which program control is terminated, and then the next program control starts.
SP Start	When the program control is started, the program control starts from the set point (SP) that is configured as "Set Point (SP) when Program Control Starts."

Examples for the PV start, PVR start and SP start actions are described using the following program pattern.

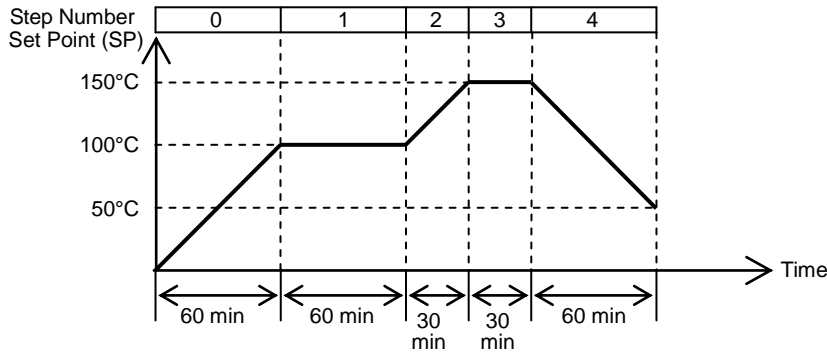

PV Start Action [Process variable (PV) is 25°C]

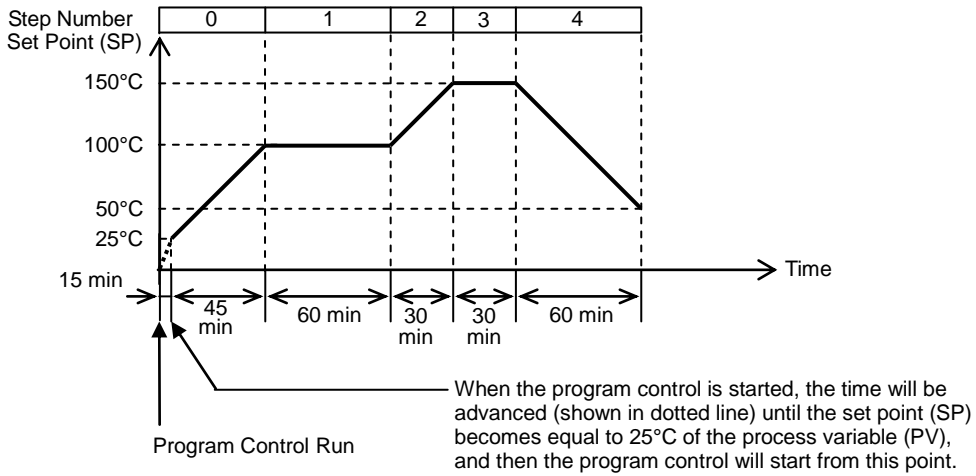

PV Start Action [Process variable (PV) is 170°C]

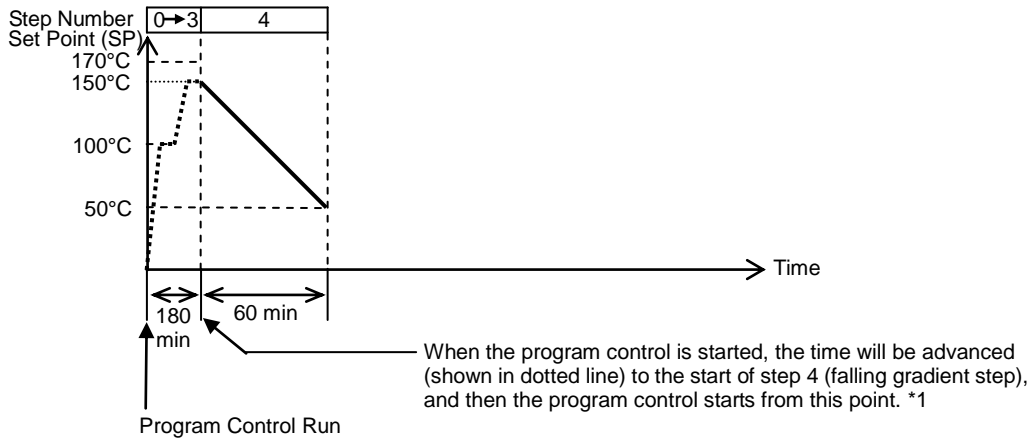

*1: In the above program pattern, if the set point (SP) of step 4 is 0°C and the step time of step 4 is 0 minutes (falling gradient step does not exist), the time will be advanced to the end of Step 3, and the program control will be terminated.

PVR Start Action [Process variable (PV) is 25°C]

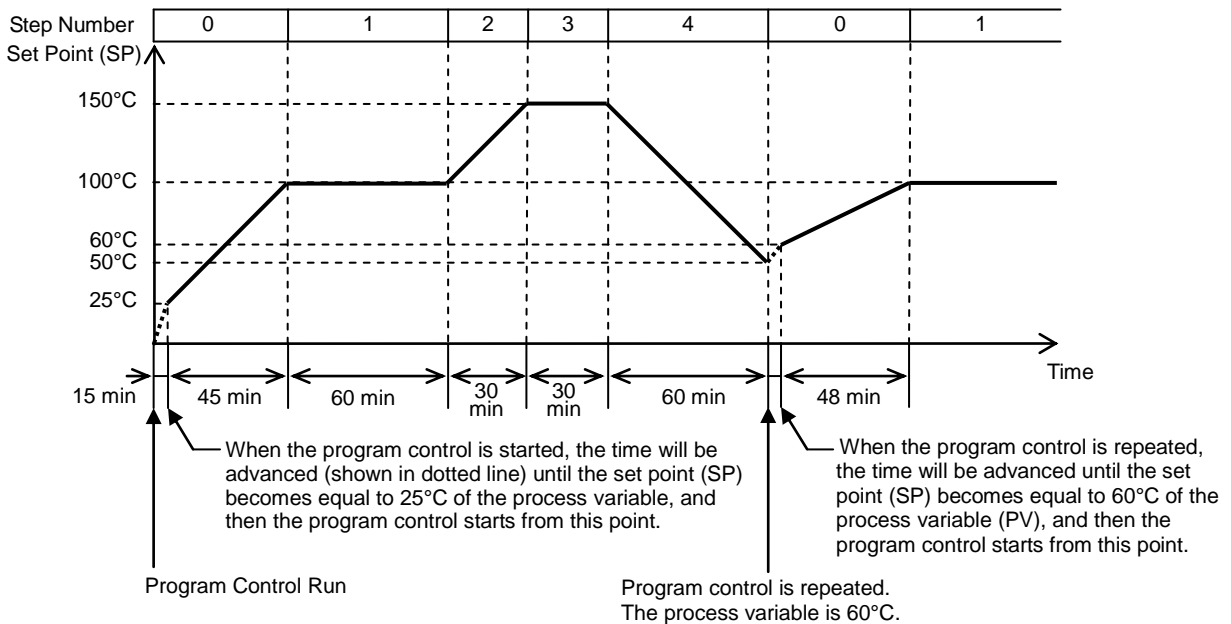

SP Start Action [Set point (SP) when Program Control Starts is 0°C]

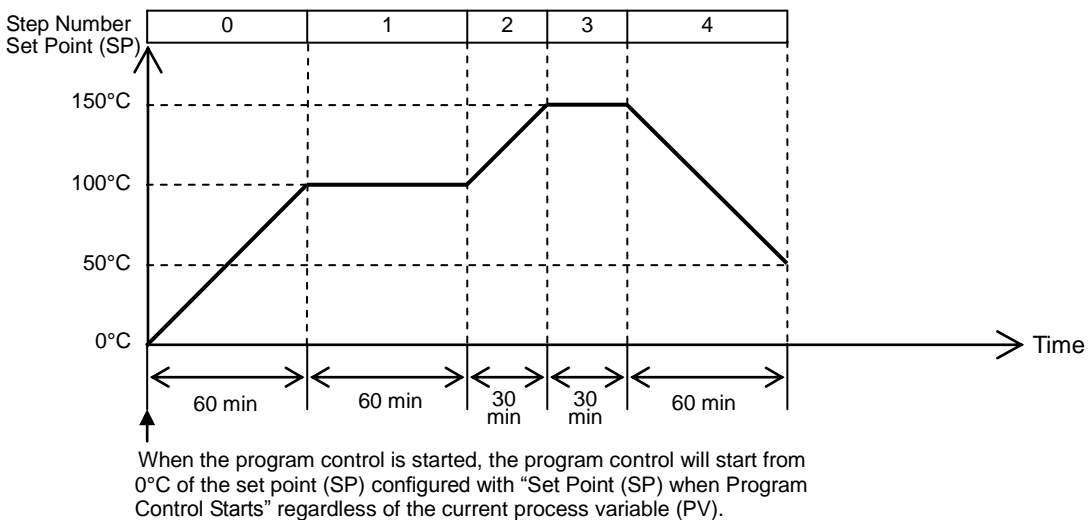

(24) Control Register+96: Set Point (SP) when Program Control Starts

The set point (SP) when program control starts can be configured. The program control starts with this set point (SP) when the SP start is selected as the program control mode start type.

(25) Control Register+92: Step Time Unit

Minute or second can be selected as the unit of program control progressing time.

(26) Control Register+93: Program End Action

The action to be taken when the program control is terminated can be selected. The program control is terminated when all steps 0 to 9 are performed and finished. Each step is performed with the parameters configured for each step. Steps to which step time 0 is configured are also performed. For example, if the program control of 4 steps is required, configure parameters of steps 0 to 3 and set the step time of the remaining steps 4 to 9 to zero.

<p>Terminate program control</p>	<p>When the program control is terminated, the program end output bit is turned on and maintained, and the PID module will be in standby status. The program control can be executed again by turning off to on the program control bit (operation parameter bit3). During the program control standby (waiting for program control run) status, the control output is turned off, and the operating status is not updated except the over range, the under range, and the program end output.</p>
<p>Continue program control (Repeat)</p>	<p>When the program control is terminated, the program control is repeated from step 0 as many times as the configured number of repeats. When the step 9 of the last program control cycle is performed and finished, the program end output bit is turned on and maintained.</p>
<p>Hold program control</p>	<p>When the program control is terminated, the program control is held at the last status of step 9. The program end output and program hold bit are turned on and maintained. While the program control is held, the fixed value control is performed with the set point (SP) of step 9. If advance next function (operation parameter Bit6 is turned off to on) is executed while the program control is held, the program control is started again from step 0. The program end output and program hold bit are turned off. While the program control is being held, the parameters of Blocks 10 to 19 and 30 to 39 can be changed. The program control can be executed again after changing the program parameters, such as the set point (SP) or step time of each step.</p>

(27) Control Register+97: Number of Repeats

The number of repeats for the program control can be configured.

Control Parameters when Cascade Control is Selected

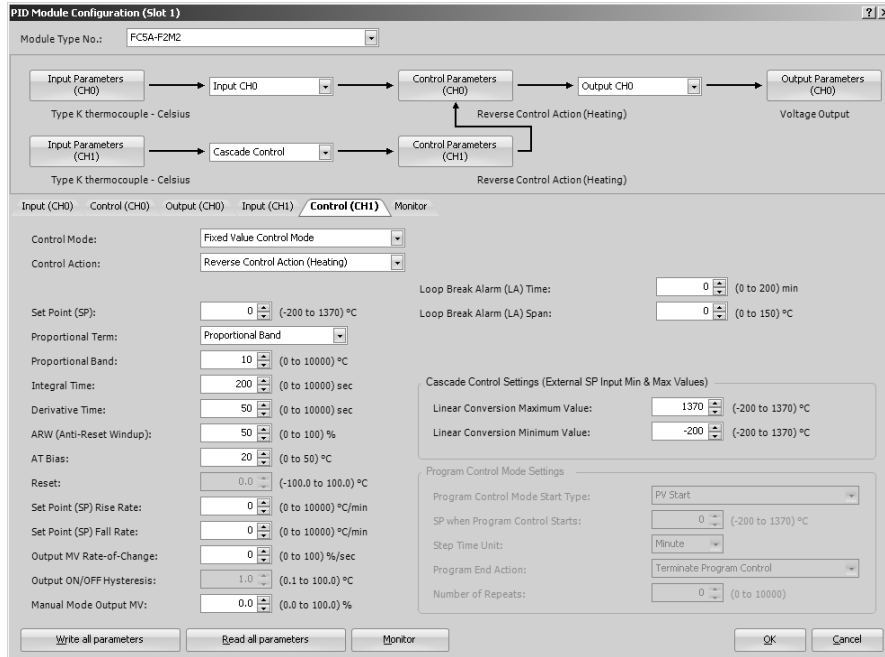

(1) Control Register+178: External SP Input Linear Conversion Maximum Value

Configure the external SP input linear conversion maximum value for the cascade control. The output manipulated variable (MV) (0 to 100%) of the master (CH1) corresponds to the set point (SP) of the slave (CH0). The range of the set point (SP) of the slave (CH0) is the external SP input linear conversion minimum value to the external SP input linear conversion maximum value.

Configure the external SP input linear conversion maximum value for when the output manipulated variable (MV) of the master (CH1) is 100%.

(2) Control Register+179: External SP Input Linear Conversion Minimum Value

Configure the external SP input linear conversion minimum value for the cascade control. The output manipulated variable (MV) (0 to 100%) of the master (CH1) corresponds to the set point (SP) of the slave (CH0). The range of the set point (SP) of the slave (CH0) is the external SP input linear conversion minimum value to the external SP input linear conversion maximum value.

Configure the external SP input linear conversion minimum value for when the output manipulated variable (MV) of the master (CH1) is 0%.

PID Module Configuration - Output Parameters Details

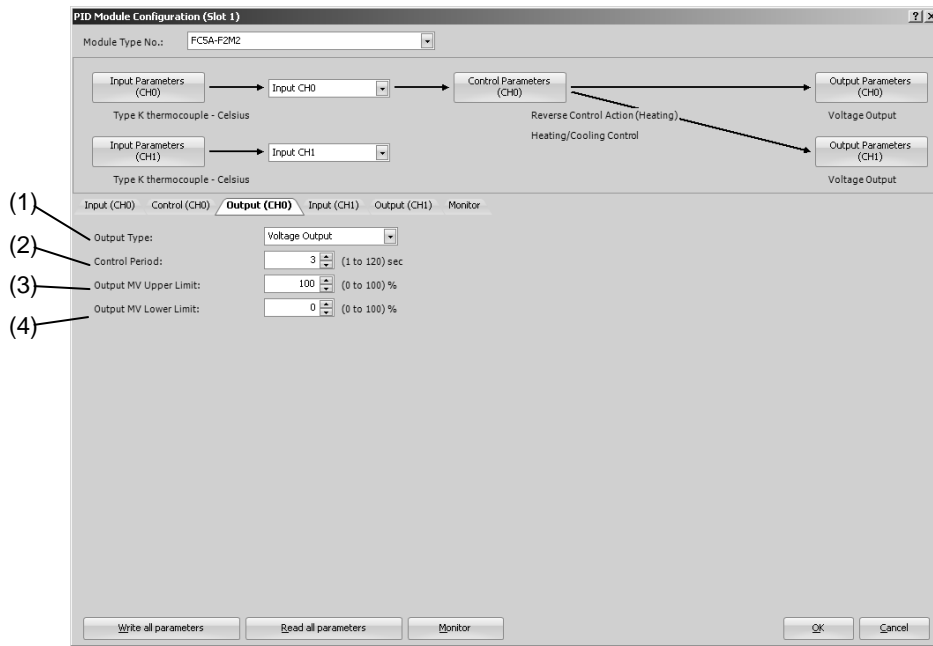

Output Parameters when Heating/Cooling Control is Enabled

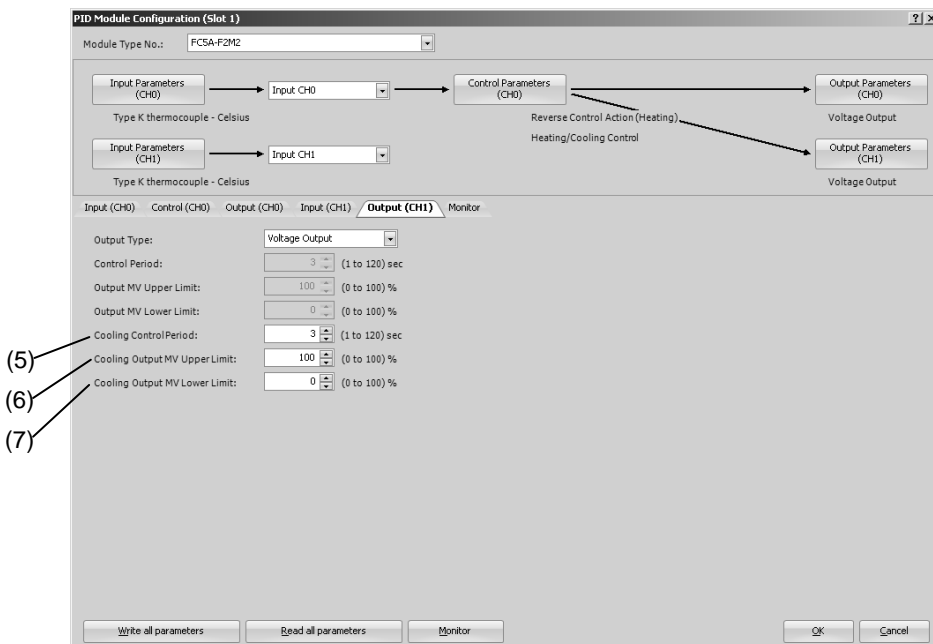

Output parameters of CH0 control are described here. When the heating/cooling control is enabled, the control period and the output manipulated variable (MV) upper and lower limits of CH1 are disabled. The parameters (5) to (7) are enabled.

Output parameters for CH1 control are the same as those of CH0 control except the cooling control parameters. However, the positions from the control register for each parameter differs. For details about the positions from the control register of CH1 control, see 5-17 to 5-20

(1) Control Register+99: Output Type

Select the output type for the FC5A-F2M2. Voltage or current output can be selected.

- Voltage output: 12V DC±15%
- Current output: 4 to 20mA DC

(2) Control Register+30: Control Period

The control period determines the duration of the ON/OFF cycle of the control output that is turned on and off according to the output manipulated variable (MV) calculated by the PID control action. The ON pulse duration of the control output is determined by the product of the control period and the output manipulated variable (MV).

When the heating/cooling control is enabled, the control period will be the heating control period. When the output type is current, the control period is disabled.

Example: When the control period is 5 sec:

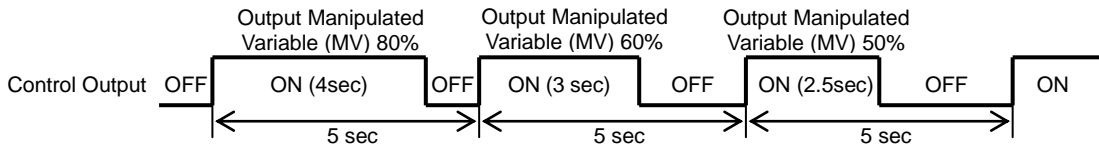

(3) Control Register+46: Output Manipulated Variable Upper Limit

This value specifies the upper limit of the output manipulated variable (MV). The output manipulated variable upper limit is used to suppress the output manipulated variable (MV).

Example:

When the output manipulated variable (MV) upper limit is 80%, the control output will be 80% even when the output manipulated variable (MV) reaches 100%.

(4) Control Register+47: Output Manipulated Variable Lower Limit

This value specifies the lower limit of the output manipulated variable (MV).

Example:

When the output manipulated variable (MV) lower limit is 20%, the control output will be 20% even when the output manipulated variable (MV) is 0%.

(5) Control Register+49: Cooling Control Period

When the heating/cooling control is enabled, the cooling control period determines the duration of the ON/OFF cycle of the cooling control output that is turned on and off according to the cooling output manipulated variable (MV) calculated by the PID control action.

(6) Control Register+51: Cooling Output Manipulated Variable Upper Limit

This value specifies the upper limit of the cooling output manipulated variable (MV). The cooling output manipulated variable upper limit is used to suppress the cooling output manipulated variable (MV).

Example:

When the cooling output manipulated variable (MV) upper limit is 80%, the cooling control output will be 80% even when the cooling output manipulated variable (MV) reaches 100%.

(7) Control Register+52: Cooling Output Manipulated Variable Lower Limit

This value specifies the lower limit of the cooling output manipulated variable (MV).

Example:

When the cooling output manipulated variable (MV) lower limit is 20%, the cooling control output will be 20% even when the cooling output manipulated variable (MV) is 0%.

PID Module Configuration - Program Parameters Details

	Range	Monitor											
		Step 0	Step 1	Step 2	Step 3	Step 4	Step 5	Step 6	Step 7	Step 8	Step 9		
(1) Set Point (SP)	(-200 to 1370) °C	0	0	0	0	0	0	0	0	0	0	0	0
(2) Step Time	(0 to 6000) min	0	0	0	0	0	0	0	0	0	0	0	0
(3) Wait Value	(0 to 100) °C	0	0	0	0	0	0	0	0	0	0	0	0
(4) Proportional Band	(0 to 10000) °C	10	10	10	10	10	10	10	10	10	10	10	10
(5) Integral Time	(0 to 10000) sec	200	200	200	200	200	200	200	200	200	200	200	200
(6) Derivative Time	(0 to 10000) sec	50	50	50	50	50	50	50	50	50	50	50	50
(7) ARW (Anti-Reset Windup)	(0 to 100) %	50	50	50	50	50	50	50	50	50	50	50	50
(8) Output MV Rate-of-Change	(0 to 100) %/sec	0	0	0	0	0	0	0	0	0	0	0	0
(9) Alarm 1 Value	(-1570 to 1570) °C	0	0	0	0	0	0	0	0	0	0	0	0
(10) Alarm 2 Value	(-1570 to 1570) °C	0	0	0	0	0	0	0	0	0	0	0	0
(11) Alarm 3 Value	(-1570 to 1570) °C	0	0	0	0	0	0	0	0	0	0	0	0
(12) Alarm 4 Value	(-1570 to 1570) °C	0	0	0	0	0	0	0	0	0	0	0	0
(13) Alarm 5 Value	(-1570 to 1570) °C	0	0	0	0	0	0	0	0	0	0	0	0
(14) Alarm 6 Value	(-1570 to 1570) °C	0	0	0	0	0	0	0	0	0	0	0	0
(15) Alarm 7 Value	(-1570 to 1570) °C	0	0	0	0	0	0	0	0	0	0	0	0
(16) Alarm 8 Value	(-1570 to 1570) °C	0	0	0	0	0	0	0	0	0	0	0	0
(17) Output MV Upper Limit	(0 to 100) %	100	100	100	100	100	100	100	100	100	100	100	100
(18) Output MV Lower Limit	(0 to 100) %	0	0	0	0	0	0	0	0	0	0	0	0
(19) Cooling Proportional Band	(0.0 to 10.0) times	1	1	1	1	1	1	1	1	1	1	1	1
(20) Overlap/Dead Band	(-200.0 to 200.0) °C	0	0	0	0	0	0	0	0	0	0	0	0

The program parameters of step 0 of CH0 control are described here. The parameters of steps 1 to 9 of CH0 and parameters of steps 0 to 9 of CH1 control are the same as those of step 0 of CH0 control. However, the positions from the control register for each parameter differs. For details about the positions from the control register for each program parameter, see 5-22 to 5-24.

(1) Control Register+180: Set Point (SP)

Configure the set point (SP) at the end of the step. Any value within the following range can be configured:

When input is thermocouple or resistance thermometer:

$$\text{Set point (SP) lower limit} \leq \text{Set point (SP)} \leq \text{Set point (SP) upper limit}$$

When input is voltage or current:

$$\text{Linear conversion minimum value} \leq \text{Set point (SP)} \leq \text{Linear conversion maximum value}$$

(2) Control Register+181: Step Time

The process time of each step can be configured as the step time.

When the set point (SP) is 500°C and the step time is 30 minutes, the PID module gradually increases the set point (SP) to 500°C in 30 minutes. If the PV Start or PVR Start is selected as the program control mode start type, when the program control is started, the time is advanced until the set point (SP) becomes equal to the process variable (PV). Then the program control starts and the set point is gradually increased to 500°C at the end of the step. If the SP Start is selected as the program control mode start type, the set point (SP) is increased from the set point (SP) specified with "Set Point (SP) when Program Control Starts" to the set point (SP) of step 0 in 30 minutes.

See page 6-41 and 6-42 for details about the program control mode start type.

(3) Control Register+182: Wait Value

During the program control running, when a step is finished, the PID module checks whether the deviation between the process variable (PV) and set point (SP) is less than or equal to the wait value. The program control is not proceeded to the next step until the deviation becomes less than or equal to the wait value.

The wait function does not work and the program control is proceeded to the next step if the process variable (PV) satisfies the following condition:

$$\text{Set Point (SP)} - \text{Wait Value} \leq \text{Process Variable (PV)} \leq \text{Set Point (SP)} + \text{Wait Value}$$

Example 1: Wait function when the temperature is rising

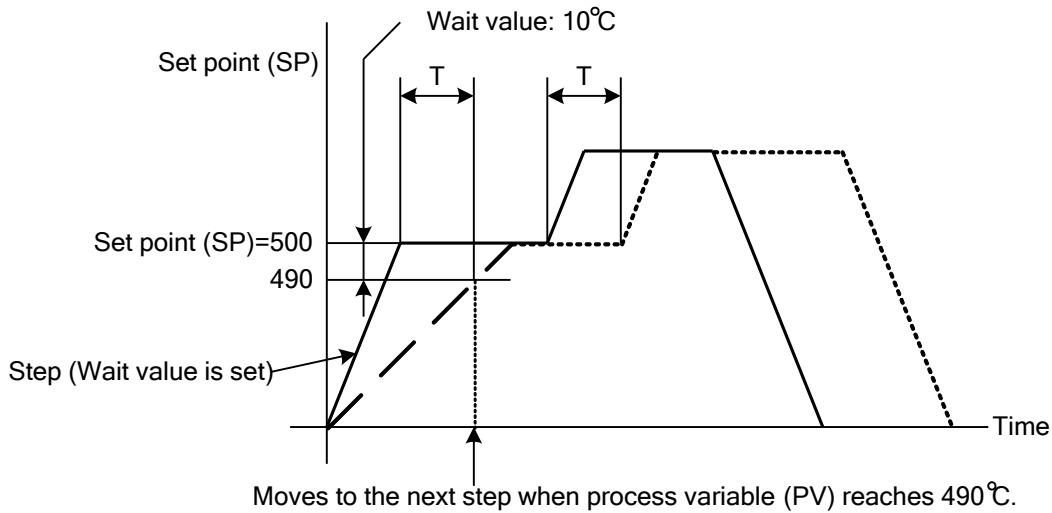

Example 2: Wait function when the temperature is falling

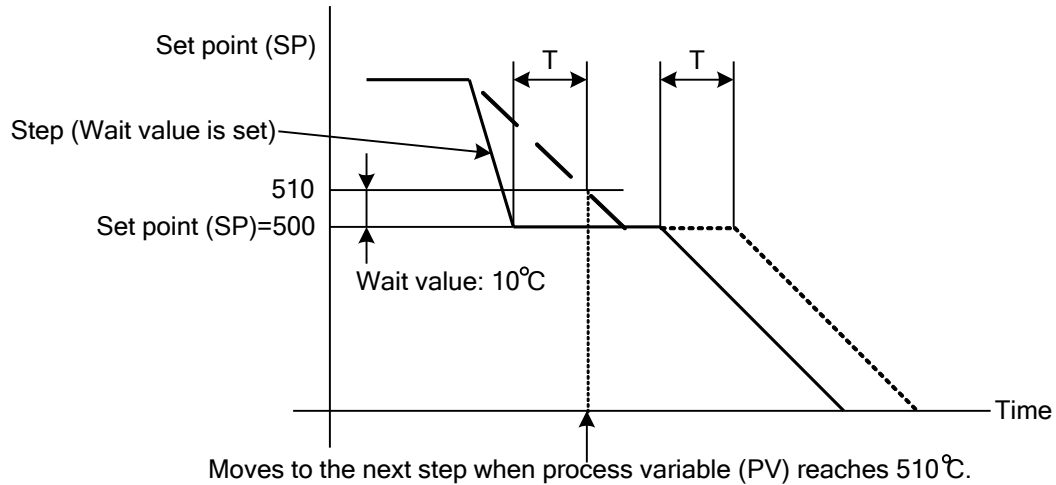

- : Program pattern
- — — — : Process variable (PV)
- : Program pattern delayed by T due to the wait function

How to Cancel Wait Function

The wait function can be cancelled for the program control to proceed to the next step by turning on the advance next step bit, which is the bit 6 of the operation parameter.

(4) Control Register+183: Proportional Term

The output of the proportional action varies in proportion to the deviation between the set point (SP) and the process variable (PV). When the heating/cooling control is enabled, this parameter becomes the heating proportional band. The control action will be ON/OFF control when the proportional band/proportional gain is 0. If the proportional band is broadened (proportional gain is made smaller), the control output starts turning on or off at the significantly low temperatures from the set point (SP), overshoot or hunting is reduced; however, it takes time for the process variable (PV) to reach the set point (SP), and offset between the process variable (PV) and the set point (SP) is broadened.

If the proportional band is narrowed (proportional gain is made larger), the control output starts turning on or off at around the set point (SP), the time until the process variable (PV) reaches the set point (SP) is shortened, and the offset is small; however, the hunting phenomenon is frequent. If the proportional band is greatly narrowed, the control action becomes similar to the ON/OFF control action.

An appropriate proportional band/proportional gain for the control target can be automatically calculated using auto-tuning (AT) function. It is unnecessary to configure the proportional band/proportional gain in the WindLDR when using the auto-tuning (AT) function.

(5) Control Register+184: Integral Time

In the proportional control action, the offset is generated even when the control is stabilized. The integral action corrects the offset. The integral action is disabled when the integral time is 0.

The integral time is a coefficient to determine the output manipulated variable (MV) of the integral action.

If the integral time is shortened too much, the integral action becomes strong. The offset can be corrected in a shorter time; however, the hunting phenomenon may be caused over a long cycle. On the contrary, if the integral time is extended too much, the integral action becomes weak and it takes time to correct the offset.

An appropriate integral time for the control target can be automatically calculated using auto-tuning (AT) function. It is unnecessary to configure the integral time in the WindLDR when using the auto-tuning (AT) function.

(6) Control Register+185: Derivative Time

When the set point (SP) is changed or when the deviation between the set point (SP) and the process variable (PV) is increased due to a disturbance, the derivative action increases the output manipulated variable (MV) to rapidly correct the deviation between the process variable (PV) and the set point (SP). The derivative time is a coefficient to determine the output manipulated variable (MV) of the derivative action. The derivative action is disabled when the derivative time is 0.

If the derivative time is shortened, the derivative action becomes weak. The response to the rapid temperature change becomes slower. Because the action to suppress the rapid temperature rise becomes weaker, the time for the process variable (PV) to reach the set point (SP) is shortened; however, overshoot can occur.

If the derivative time is extended, the derivative action becomes strong. The response to the rapid temperature change becomes faster. Because the action to suppress the rapid temperature rise becomes strong, the time for the process variable (PV) to reach the set point (SP) is extended; however, overshoot can be decreased.

An appropriate derivative time for the control target can be automatically calculated using auto-tuning (AT) function. It is unnecessary to configure the derivative time in the WindLDR when using the auto-tuning (AT) function.

(7) Control Register+186: ARW (Anti-Reset Windup)

When the control is started, there is a large deviation between the set point (SP) and the process variable (PV). The integral action continues its action in a given direction until the process variable (PV) reaches the set point (SP). As a result, an overshoot is caused by the excessive integral action. ARW suppresses the overshoot by limiting the integral action area.

When ARW is 0%, the integral action area becomes the minimum and the suppression of the overshoot is maximized. When ARW is 50%, the integral action area becomes the intermediate and the suppression of the overshoot is intermediate. When ARW is 100%, the integral action area becomes the maximum and the suppression of the overshoot is minimized.

An appropriate ARW for the control target can be automatically calculated using auto-tuning (AT) function. It is unnecessary to configure the ARW in the WindLDR when using the auto-tuning (AT) function.

(8) Control Register+187: Output Manipulated Variable Rate-of-Change

The maximum change of the output manipulated variable in 1 minute can be configured. This function is disabled when the value is 0.

In the case of heating control, when there is a large deviation between the process variable (PV) and the set point (SP), the output immediately changes from off to on as shown in the diagram below (Normal Output). By configuring the output manipulated variable rate-of-change, the maximum change of the output manipulated variable (MV) in 1 minute can be changed as shown in the diagram below (Output When Output Manipulated Variable Rate-of-Change is Configured).

This function can be used for a high temperature heater (used at approximately 1500 to 1800°C) which has to be heated gradually, as the heater can be burnt out if the power is supplied rapidly.

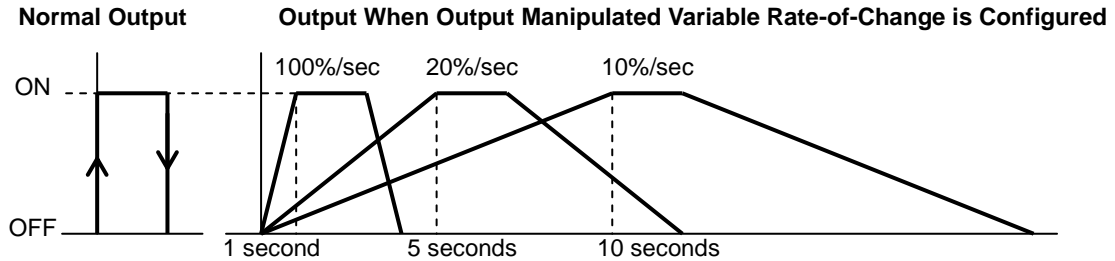

- (9) Control Register+188: Alarm 1 Value
- (10) Control Register+189: Alarm 2 Value
- (11) Control Register+190: Alarm 3 Value
- (12) Control Register+191: Alarm 4 Value
- (13) Control Register+192: Alarm 5 Value
- (14) Control Register+193: Alarm 6 Value
- (15) Control Register+194: Alarm 7 Value
- (16) Control Register+195: Alarm 8 Value

There are two types of alarms: Deviation alarm and process alarm.

	Alarm Type	Alarm Value	Alarm Action
Deviation Alarm	Upper/Lower limit range alarm	Deviation from the set point (SP) is the alarm value.	The alarm output turns off if the process variable (PV) exceeds the range.
	Upper limit alarm, Lower limit alarm, Upper/Lower limits alarm, Upper limit alarm with standby, Lower limit alarm with standby, Upper/Lower limits alarm with standby		The alarm output turns on if the process variable (PV) exceeds the range.
Process Alarm	Process high alarm Process low alarm	The alarm action point is the alarm value.	The alarm output turns on if the process variable (PV) exceeds the alarm value.

When the alarm value is 0, the alarm action is disabled except process high alarm and process low alarm.

(17) Control Register+197: Output Manipulated Variable Upper Limit

This value specifies the upper limit of the output manipulated variable (MV). The output manipulated variable upper limit is used to suppress the output manipulated variable (MV).

Example:

When the output manipulated variable (MV) upper limit is 80%, the control output will be 80% even when the output manipulated variable (MV) reaches 100%.

(18) Control Register+19: Output Manipulated Variable Lower Limit

This value specifies the lower limit of the output manipulated variable (MV).

Example:

When the output manipulated variable (MV) lower limit is 20%, the control output will be 20% even when the output manipulated variable (MV) is 0%.

(19) Control Register+199: Cooling Proportional Band

The cooling proportional band can be configured when the heating/cooling control is enabled. The cooling proportional band is the multiplication of the heating proportional band.

Example:

When the heating proportional band is 10°C and the cooling proportional band is 2.0, the cooling proportional band will be 20°C. If cooling proportional band value is 0.5, the cooling proportional band will be 5°C.

If the cooling proportional band is 0, the cooling side control will be ON/OFF control action. If the heating proportional band is 0, both heating and cooling side controls will be ON/OFF control action.

(20) Control Register+200: Overlap/Dead Band

The overlap/dead band of the heating and cooling outputs can be configured when heating/cooling control is enabled. When the configured value is bigger than 0, the value is used as the dead band. When the configured value is less than 0, the value is used as overlap band.

When the overlap band is configured, the area in which both heating and cooling control outputs are turned on is generated, and the energy loss is caused. However, the overlap helps enhance the control accuracy and accelerate the response.

When the dead band is configured, the area in which neither heating nor cooling control outputs are turned on is generated. In the dead band, the control accuracy and responsiveness is lowered; however, the energy loss can be suppressed.

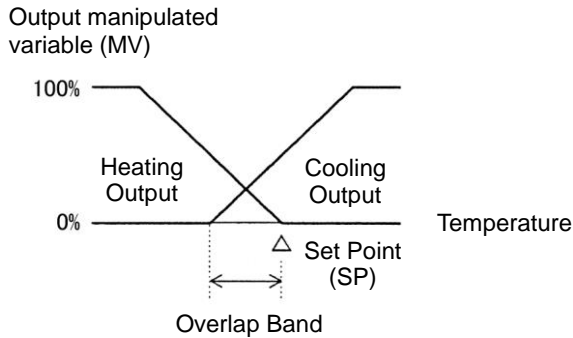

Overlap Band Action

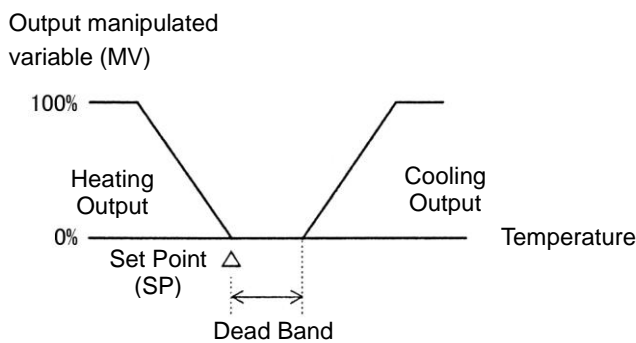

Dead Band Action

Monitoring PID Module

The PID Module status can be monitored on the monitoring screen. Click on Monitor tab in the PID Module Configuration dialog box to open the monitoring screen

Monitoring Screen

When external PV mode is disabled

To start monitoring the PID module, click on Monitor button in the PID Module Configuration dialog box.

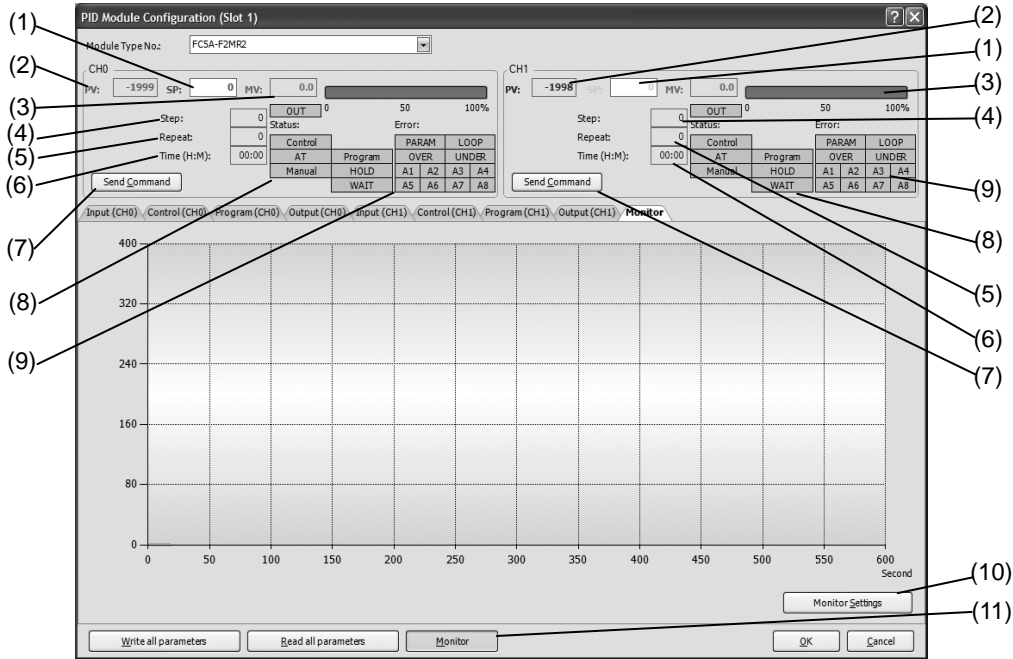

When external PV mode is enabled

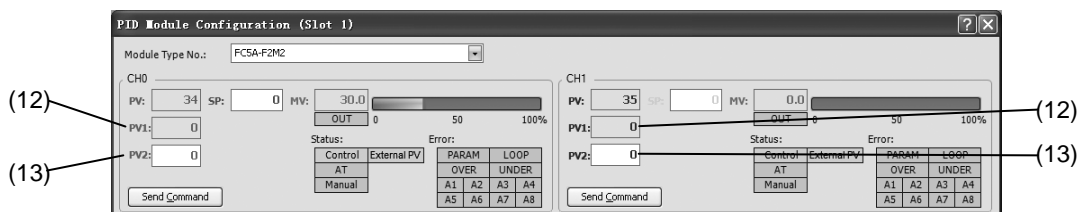

(1) CH0/CH1 SP (Set Point)

The set point (SP) of CH0 or CH1 is indicated. During the monitoring, set point (SP) of CH0 or CH1 can be changed.

(2) CH0/CH1 PV (Process Variable)

The process variable (PV) of CH0 or CH1 is indicated.

(3) CH0/CH1 MV (Output Manipulated Variable)

The output manipulated variable (MV) of CH0 or CH1 is indicated. The bar graph on the right is also updated according to the output manipulated variable (MV). While the output is on, the OUT indicator turns green. While CH0 or CH1 is in manual mode, output manipulated variable can be changed.

(4) CH0/CH1 Step

The current step number (0 to 9) is indicated when CH0 or CH1 is in program control mode.

(5) CH0/CH1 Repeat

The remaining repeat number is indicated when CH0 or CH1 is in program control mode.

(6) CH0/CH1 Time

The remaining time in the current step is indicated when CH0 or CH1 is in program control mode.

(7) CH0/CH1 Send Command

When a menu is selected, a command to control the PID module is sent.

Control:	Enable/Disable the control to the PID module.
AT/Auto-reset:	Perform auto-tuning (AT)/auto-reset or cancel auto-tuning (AT).
Manual Mode:	Enable manual/auto mode.
External SP Input (CH0 only):	Enable/Disable the external SP input.
Program Control:	Run/Stop the program control, advance next/previous step, or hold/run the program control.
External PV Mode:	Enable/Disable the external PV mode.

(8) CH0/CH1 Status Indicators

Control:	Turns green while the control of CH0/CH1 is enabled
AT:	Turns green while auto-tuning (AT) is performed for CH0/CH1.
Manual:	Turns green while CH0/CH1 is in the manual control.
External SP (CH0 only):	Turns green while the external SP input is enabled.
Program (Program control only):	Turns green while CH0/CH1 is in program control mode.
HOLD (Program control only):	Turns green while the program control of CH0/CH1 is held.
WAIT (Program control only):	Turns green while the program wait is functioning for CH0/CH1.
External PV:	Turns green while the external PV mode is enabled.

(9) CH0/CH1 Error Indicators

PARAM:	Turns red while parameter range error is occurring.
LOOP:	Turns red while loop break alarm is turned on.
UP:	Turns red while the input is over range.
DOWN:	Turns red while the input is under range.
A1 to A8:	Turns red while the corresponding alarm is turned on.

(10) Monitor Settings

Click on Monitor Settings button to open the PID Module Monitor Settings dialog box.

(11) Monitor

Click on Monitor button to start monitoring and tracing the PID module.

(12) CH0/CH1 Current Process Variable with Decimal Point (PV1)

The current process variable with decimal point (PV1) for CH0 and CH1 is indicated when external PV mode (CH0/CH1) is enabled.

(13) CH0/CH1 External PV Mode Process Variable (PV2)

The external PV mode process variable (PV2) for CH0 and CH1 is indicated when external PV mode (CH0/CH1) is enabled.

PID Module Monitor Settings dialog box

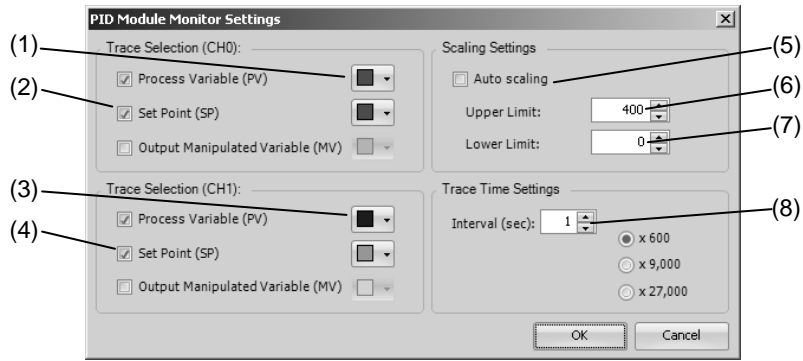

(1) CH0 Trace Color Selection

Select the color for the three parameters to be traced.

(2) CH0 Trace Selection

Select the parameter to be traced. If none of the three parameters are selected, CH0 parameters are not traced and only parameters are monitored.

(3) CH1 Trace Color Selection

Select the color for the three parameters to be traced.

(4) CH1 Trace Selection

Select the parameter to be traced. If none of the three parameters are selected, CH1 parameters are not traced and only parameters are monitored.

(5) Auto Scaling

If the auto scaling is enabled, the range of the vertical axis is automatically updated in accordance with the process variable (PV), set point (SP) and output manipulated variable (MV).

(6) Upper Limit

The upper limit of the vertical axis for the trace can be specified.

(7) Lower Limit

The lower limit of the vertical axis for the trace can be specified.

(8) Trace Time Settings

Interval: Configure the interval time for the tracing between 1 to 60 seconds

x600: Interval x 600 = Trace range
 Example: If the interval time is 1 sec, the trace range will be 600 sec. When the traced data reaches the right edge, the first half of the traced data is cleared, and the trace continues.

x9000: Interval x 9000 = Trace end time
 Example: If the interval time is 1 sec, the trace end time will be 9000 sec. The trace will be finished in 150 minutes.

x27000: Interval x 27000 = Trace end time
 Example: If the interval time is 1sec, the trace end time will be 27000 sec. The trace will be finished in 450 minutes.

Monitoring Screen Example

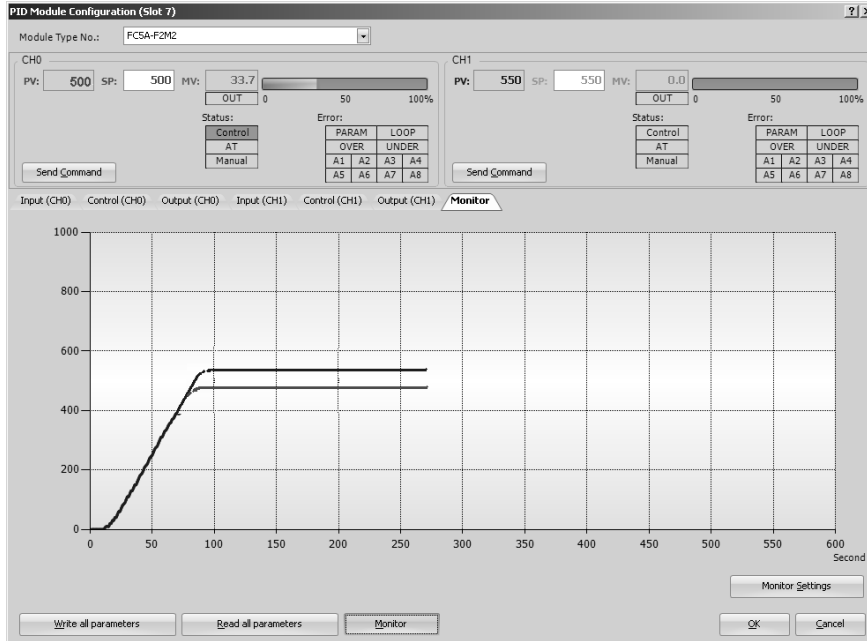

7: APPLICATION EXAMPLES

This chapter describes the PID modules application examples.

Application Example 1

This application example demonstrates the temperature control for a system using two electric furnaces. The set point (SP) of CH0 control is 200°C. The set point (SP) of CH1 control is 210°C.

- PID control is performed based on the temperature input to the PID module. The control output is turned on or off in accordance with the output manipulated variable (MV).
- PID parameters (proportional band/proportional gain, integral time, derivative time, and ARW) are automatically calculated using auto-tuning (AT).
- If the process variable (PV) of CH0 control becomes 205°C or higher, the upper limit alarm output (Q0) is turned on and the control is disabled.
- If the process variable (PV) of CH1 control becomes 215°C or higher, the upper limit alarm output (Q1) is turned on and the control is disabled.

System Configuration and Wiring

Wiring Example of the FC5A-F2M2 [Non-contact voltage output (for SSR drive)/current output type]

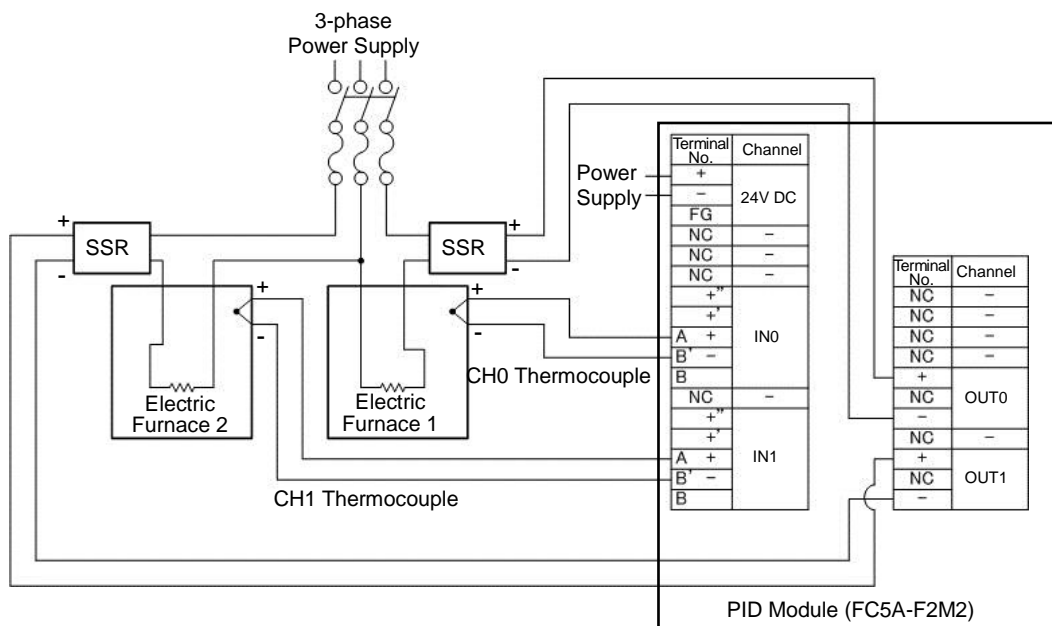

PID Module Parameter Configuration

The parameters of the PID module can be configured in the Expansion Modules Configuration and PID Module Configuration dialog boxes. The procedure to configure the PID module is described below.

Parameter Configuration Example

Quantity of Modules: 1 unit
 Slot Number: Slot 1
 Module Type No.: FC5A-F2M2
 Data Register: D1000
 Internal Relay: M1000
 I/O Function: Used as a 2-channel PID module

	CH0	CH1
Input	Type K thermocouple (-200 to 1370)°C	Type K thermocouple (-200 to 1370)°C
Output	Non-contact voltage output (for SSR drive)	Non-contact voltage output (for SSR drive)
Alarm 1 Type	Upper limit alarm	Upper limit alarm
Alarm 1 Value	5°C	5°C
Set Point (SP)	200°C	210°C
Control Action	PID control action [P, I, D and ARW are automatically calculated using auto-tuning (AT)]	PID control action [P, I, D and ARW are automatically calculated using auto-tuning (AT)]
AT Bias	20°C	20°C

Parameter Configuration Procedure

1. Expansion Modules Configuration

Select **Configuration > Expansion Modules** from the WindLDR menu bar to open the Expansion Modules Configuration dialog box.

In the Expansion Modules Configuration dialog, configure the quantity of modules, slot number, module type number, control register (data register) and control relay (internal relay). Click on **Configure Parameters** button to open the PID Module Configuration dialog box.

Expansion Modules Configuration Dialog Box

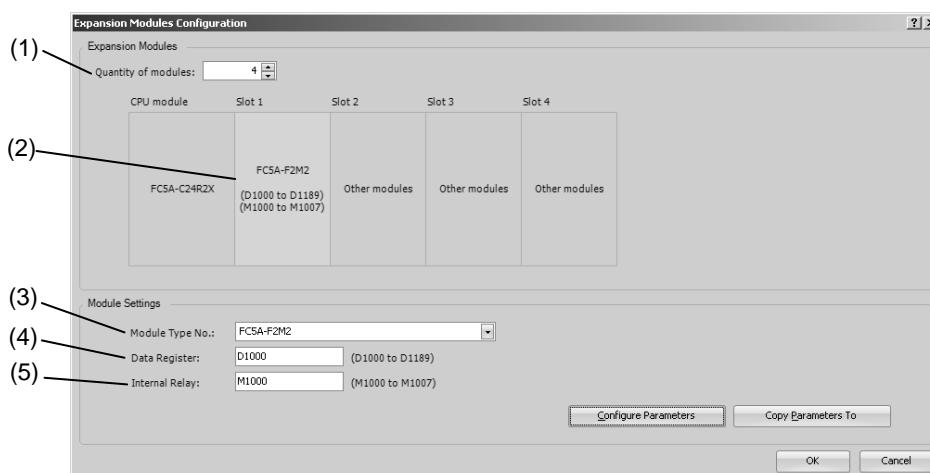

	Item	Setting
(1)	Quantity of Modules	1
(2)	Slot No.	Slot 1
(3)	Module Type No.	FC5A-F2M2
(4)	Data Register	D1000
(5)	Internal Relay	M1000

2. I/O Function Selection

Select I/O function for each channel in the PID Module Configuration dialog box.

PID Module Configuration Dialog Box (I/O Function Selection)

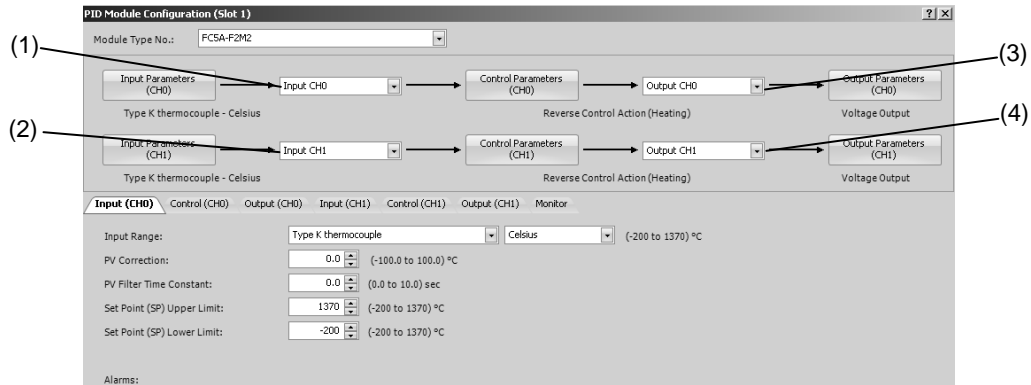

	Item	Setting
(1)	Input CH0 Function	Input CH0
(2)	Input CH1 Function	Input CH1
(3)	Output CH0 Function	Output CH0
(4)	Output CH1 Function	Output CH1

3. Input CH0 Parameters

Configure the Input CH0 parameters in the PID Module Configuration dialog box. To open Input CH0 Parameters in the PID Module Configuration dialog box, click on **Input Parameters (CH0)** button or **Input (CH0)** tab.

PID Module Configuration Dialog Box (Input CH0 Parameters)

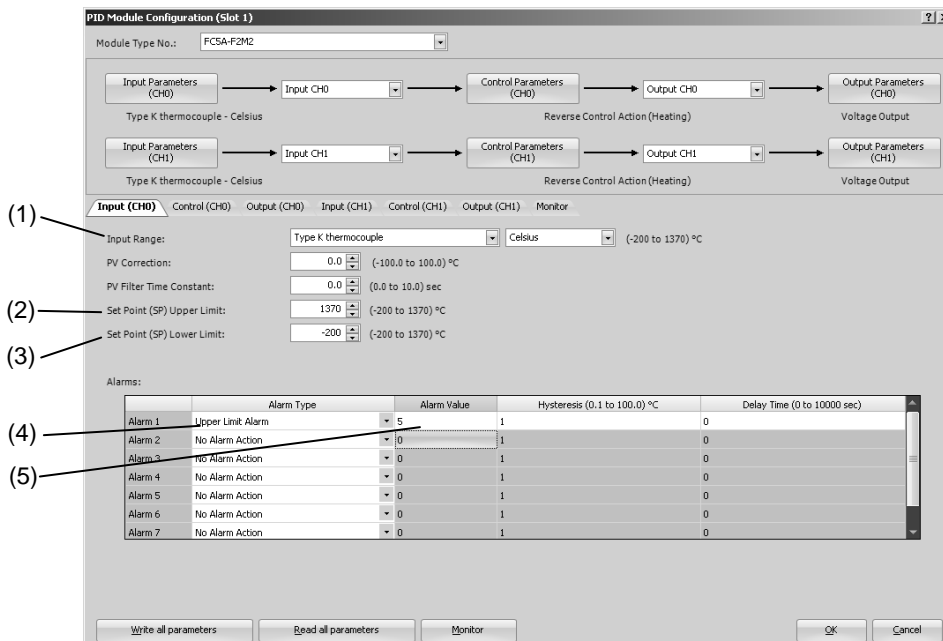

	Item	Setting
(1)	Input Range	Type K thermocouple, Celsius
(2)	Set Point (SP) Upper Limit	1370°C
(3)	Set Point (SP) Lower Limit	-200°C
(4)	Alarm 1 Type	Upper limit alarm
(5)	Alarm 1 Value	5°C

4. Control CH0 Parameters

Configure the Control CH0 parameters in the PID Module Configuration dialog box. To open Control CH0 Parameters in the PID Module Configuration dialog box, click on **Control Parameters (CH0)** button or **Control (CH0)** tab.

PID Module Configuration Dialog Box (Control CH0 Parameters)

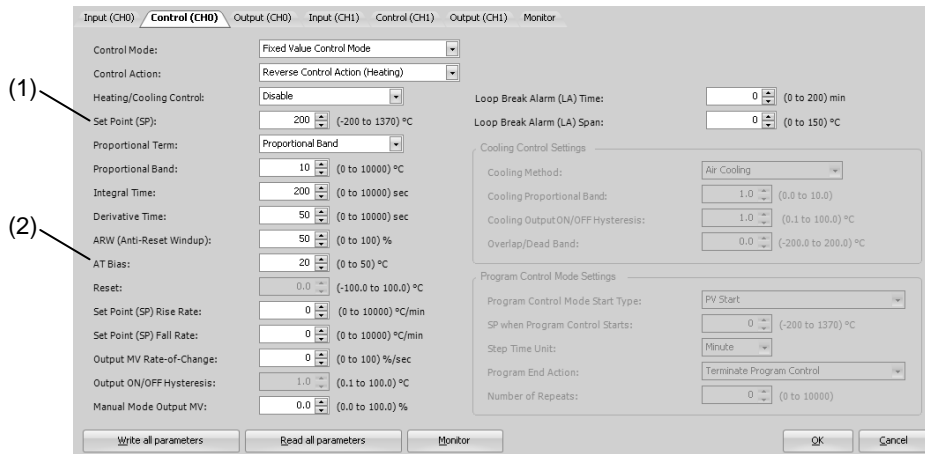

	Item	Setting
(1)	Set Point (SP)	200°C
(2)	AT Bias	20°C

5. Input CH1 Parameters

Configure the Input CH1 parameters in the PID Module Configuration dialog box. To open Input CH1 Parameters in the PID Module Configuration dialog box, click on **Input Parameters (CH1)** button or **Input (CH1)** tab.

PID Module Configuration Dialog Box (Input CH1 Parameters)

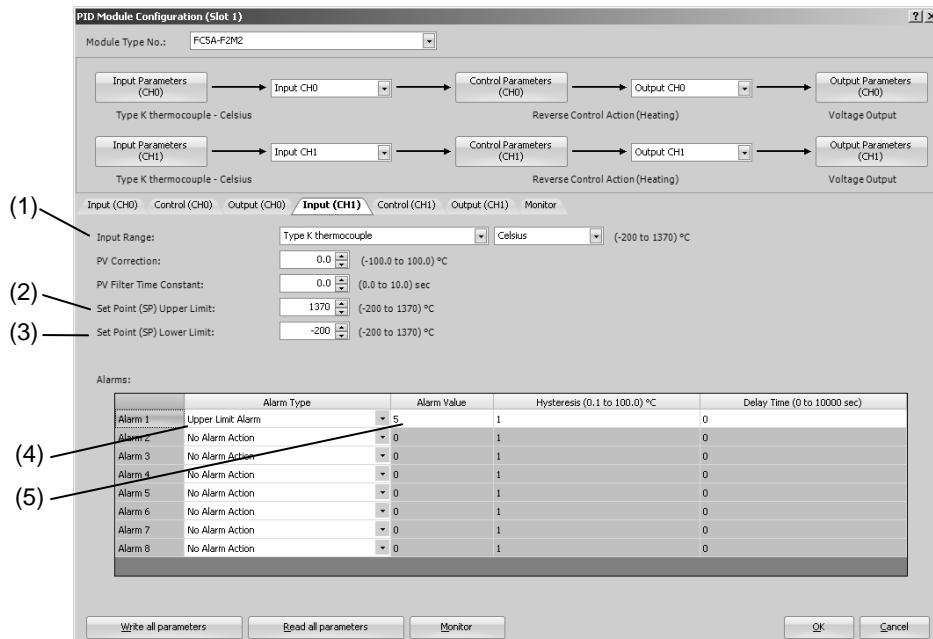

	Item	Setting
(1)	Input Range	Type K thermocouple, Celsius
(2)	Set Point (SP) Upper Limit	1370°C
(3)	Set Point (SP) Lower Limit	-200°C
(4)	Alarm 1 Type	Upper limit alarm
(5)	Alarm 1 Value	5°C

6. Control CH1 Parameters Setting

Configure the Control CH1 parameters in the PID Module Configuration dialog box. To open Control CH1 Parameters in the PID Module Configuration dialog box, click on **Control Parameters (CH1)** button or the **Control (CH1)** tab.

PID Module Configuration Dialog Box (Control CH1 Parameters)

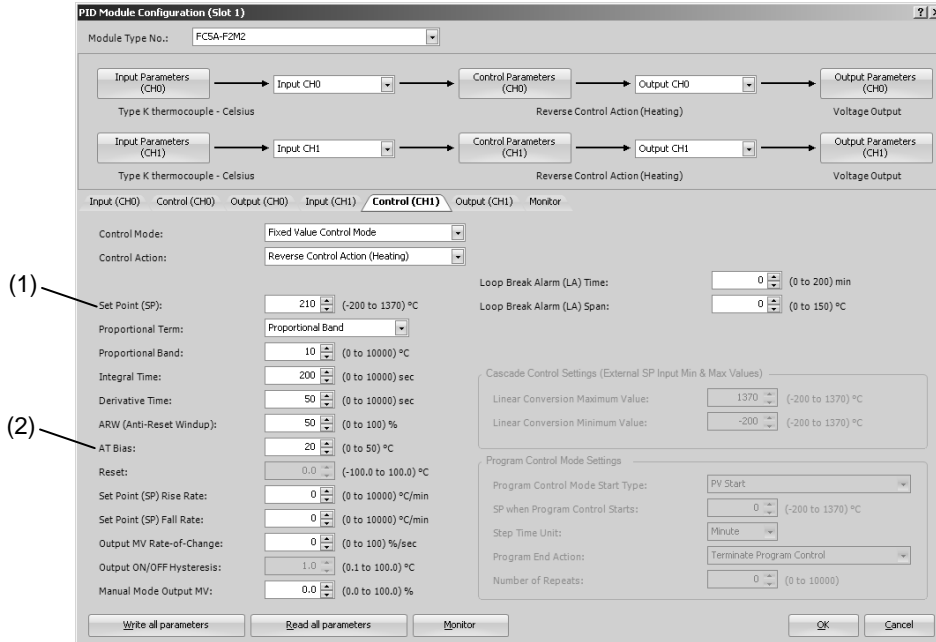

	Item	Setting
(1)	Set Point (SP)	210°C
(2)	AT Bias	20°C

7. Saving Parameters

Click **OK** button to save the configured parameters.

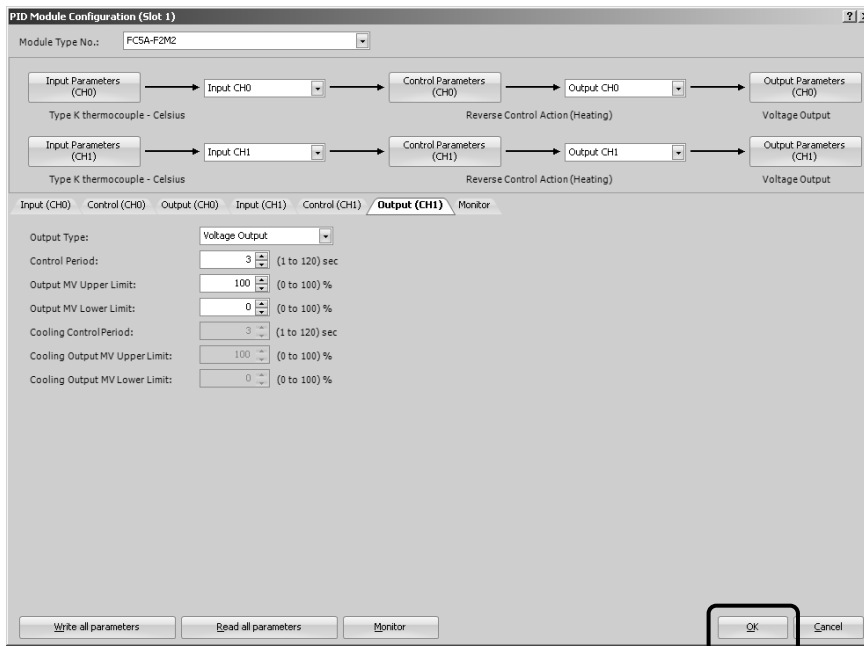

8. Ladder Programming

Create a ladder program to control the PID module.

Ladder Program Example

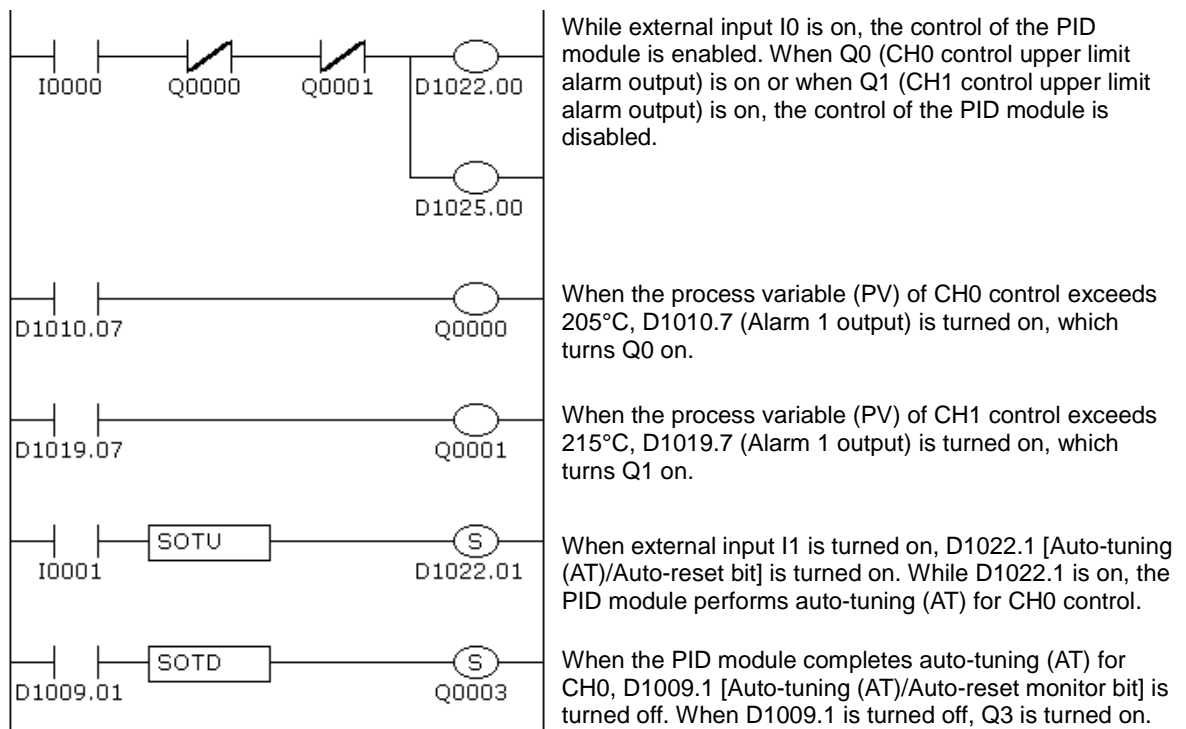

Notes:

- The temperature at which Auto-tuning (AT) is performed is determined by the set point (SP) and AT bias. In the above example, auto-tuning (AT) will be performed when the process variable (PV) reaches 180°C.
- The ladder program should be customized depending on actual applications.

9. User Program Download

From the WindLDR menu bar, select **Online > Transfer > Download** to open Download dialog box. Click the check box on the left of **Write PID Module parameters after download** and click **OK** button. The user program will be downloaded to the CPU module. After downloading the user program, the PID module parameters will be written to the data registers in the CPU module and the PID module connected to the CPU module.

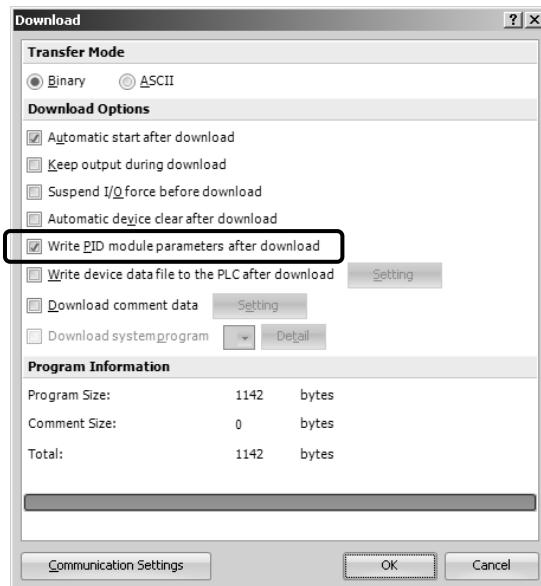

When program download is successfully completed, the following message will appear. Click **OK** button to close the message.

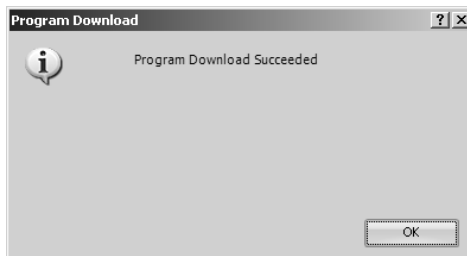

10. Starting Control

1. Confirm that 200 is stored in D1020 and 210 in D1023 of the CPU module.
2. Turn on the external input I0 to enable CH0 and CH1 controls.
3. Turn on the load circuit power.

The PID module starts the control action to keep the temperature of the control target at the set point (SP). Turn on I1 to perform the auto-tuning (AT) for CH0 control whenever necessary (see pages 4-6 to 4-8).

Application Example 2

This application example demonstrates the program control for a system using two electric furnaces for ceramic industries.

- The PID module controls electric furnace 1 with CH0 control and electric furnace 2 with CH1 control using program control.
- PID control is performed based on the temperature input to the PID module and the program pattern below. The control output is turned on or off in accordance with the output manipulated variable (MV).
- The program pattern for the program control consists of the following 4 steps.

[Step 0]: Preheat process

Step 0 is the process to gradually raise the set point (SP) to the preheat temperature (100°C) in 60 minutes to evaporate water in the specimen and electric furnace interior. When the elapsed time in step 0 is 60 minutes, if the process variable (PV) is less than 90°C, the PID module waits until the temperature reaches 90°C. When the temperature reaches 90°C, the PID module proceeds to the next step.

[Step 1]: Preheat process

Step 1 is the process to keep the preheat temperature (100°C) constant for 60 minutes.

[Step 2]: Firing process

Step 2 is the process to gradually raise the set point (SP) to the firing temperature (800°C) in 5 hours to prevent the specimen from being damaged by a rapid temperature rise. When the elapsed time in step 2 is 5 hours, if the process variable is less than 790°C, the PID module waits until the temperature reaches 790°C. When the temperature reaches 790°C, the PID module proceeds to the next step.

[Step 3]: Firing process

Step 3 is the process to keep the firing temperature (800°C) constant for 30 minutes.

- PID parameters (proportional band/proportional gain, integral time, derivative time, and ARW) of each step are automatically calculated using auto-tuning (AT).
- In CH0 control, if the process variable (PV) in step 1 becomes 110°C or higher or if the process variable (PV) in step 3 becomes 810°C or higher, the upper limit alarm output (Q0) is turned on and the control is disabled.
- In CH1 control, if the process variable (PV) in step 1 becomes 110°C or higher or if the process variable (PV) in step 3 becomes 810°C or higher, the upper limit alarm output (Q1) is turned on and the control is disabled.

System Configuration and Wiring

Wiring Example of the FC5A-F2MR2 [Relay output type]

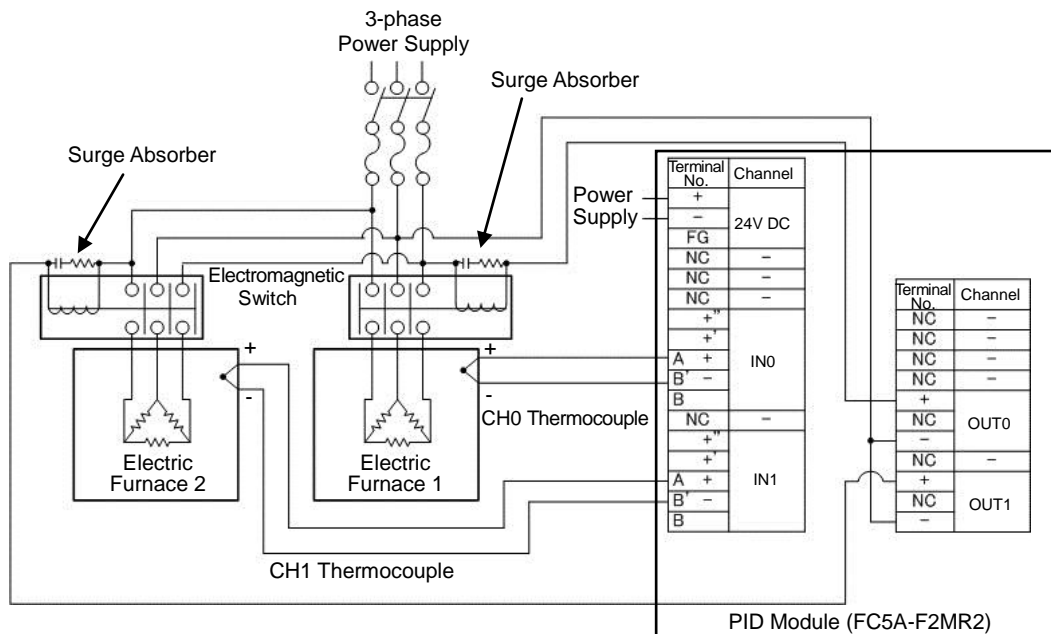

PID Module Parameter Configuration

The parameters of the PID module can be configured in the Expansion Modules Configuration and PID Module Configuration dialog boxes. The procedure to configure the PID module is described below.

Parameter Configuration Example

Quantity of Modules: 1 unit

Slot No.: Slot 1

Module Type No.: FC5A-F2MR2

Data Register: D1000

Internal Relay: M1000

I/O Function: Used as a 2-channel PID module

	CH0	CH1
Input	Type K thermocouple (-200 to 1370)°C	Type K thermocouple (-200 to 1370)°C
Output	Relay output	Relay output
Alarm 1 Type	Upper limit alarm	Upper limit alarm

Program Pattern: Settings are common between CH0 and CH1.

	Step 0	Step 1	Step 2	Step 3
Set Point (SP)	100°C	100°C	800°C	800°C
Step Time	60 minutes	60 minutes	300 minutes	30 minutes
Wait Value	10°C	0°C	10°C	0°C
Alarm 1 Value	0°C	10°C	0°C	10°C

Parameter Configuration Procedure

1. Expansion Modules Configuration

Select **Configuration > Expansion Modules** from the WindLDR menu bar to open the Expansion Modules Configuration dialog box.

In the Expansion Modules Configuration dialog, configure the quantity of modules, slot number, module type number, control register (data register) and control relay (internal relay). Click on **Configure Parameters** button to open the PID Module Configuration dialog box.

Expansion Modules Configuration Dialog Box

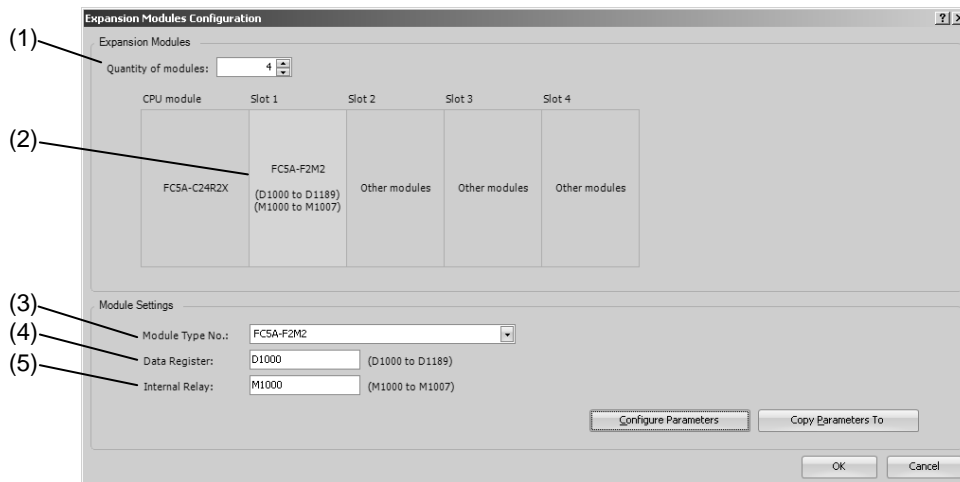

	Item	Setting
(1)	Quantity of Modules	1
(2)	Slot No.	Slot 1
(3)	Module Type No.	FC5A-F2MR2
(4)	Data Register	D1000
(5)	Internal Relay	M1000

2. I/O Function Selection

Select I/O function for each channel in the PID Module Configuration dialog box.

PID Module Configuration Dialog Box (I/O Function Selection)

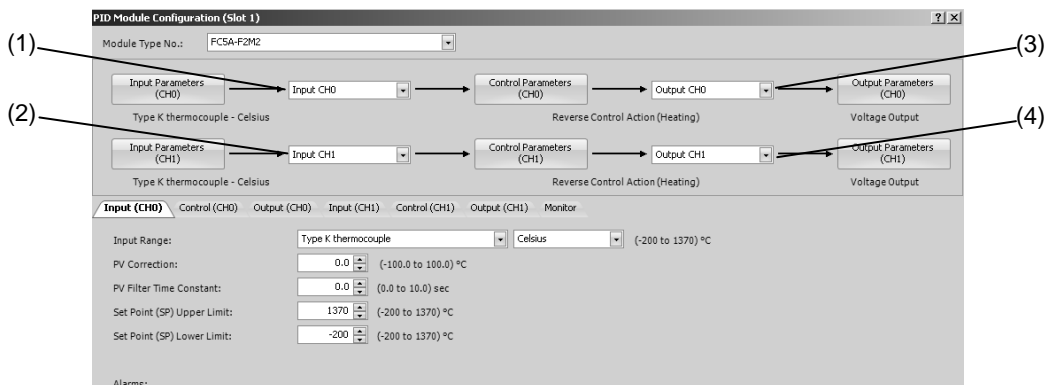

	Item	Setting
(1)	Input CH0 Function	Input CH0
(2)	Input CH1 Function	Input CH1
(3)	Output CH0 Function	Output CH0
(4)	Output CH1 Function	Output CH1

3. Input CH0 Parameters

Configure the Input CH0 parameters in the PID Module Configuration dialog box. To open Input CH0 Parameters in the PID Module Configuration dialog box, click on **Input Parameters (CH0)** button or **Input (CH0)** tab.

PID Module Configuration Dialog Box (Input CH0 Parameters)

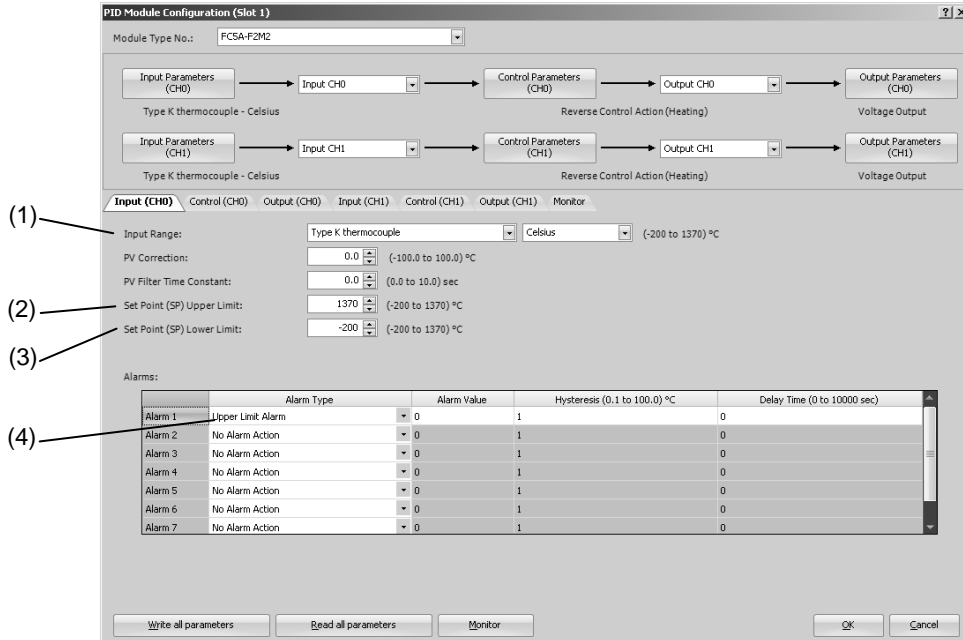

	Item	Setting
(1)	Input Range	Type K thermocouple, Celsius
(2)	Set Point (SP) Upper Limit	1370°C
(3)	Set Point (SP) Lower Limit	-200°C
(4)	Alarm 1 Type	Upper limit alarm

4. Control CH0 Parameters

Configure the Control CH0 parameters in the PID Module Configuration dialog box. To open Control CH0 Parameters in the PID Module Configuration dialog box, click on **Control Parameters (CH0)** button or **Control (CH0)** tab.

PID Module Configuration Dialog Box (Control CH0 Parameters)

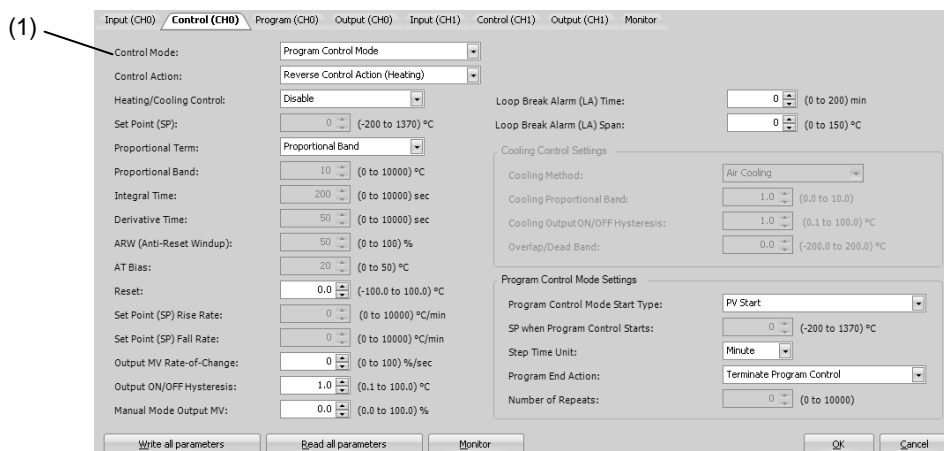

	Item	Setting
(1)	Control Mode	Program control mode

5. Program CH0 Parameters

Configure the Program CH0 parameters in the PID Module Configuration dialog box. To open Input CH1 Parameters in the PID Module Configuration dialog box, click on Program (CH0) tab.

PID Module Configuration Dialog Box (Program CH0 Parameters)

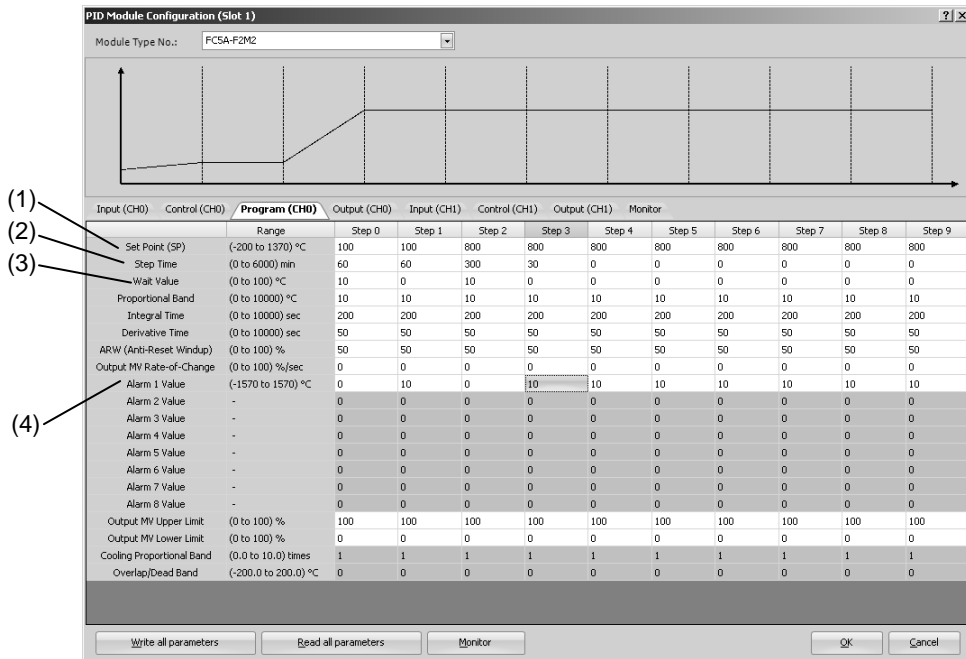

	Item	Setting			
		Step 0	Step 1	Step 2	Step 3
(1)	Set Point (SP)	100°C	100°C	800°C	800°C
(2)	Step Time	60 minutes	60 minutes	300 minutes	30 minutes
(3)	Wait Value	10°C	0°C	10°C	0°C
(4)	Alarm 1 Value	0°C	10°C	0°C	10°C

Notes:

- When the wait value is 0°C, the wait function is disabled.
- When the alarm value is 0°C, the alarm function is disabled.
- When a parameter for the program control except step time is changed in WindLDR, the parameter is automatically copied to the following steps.

6. CH1 Parameters Setting

Configure CH1 Parameters in the same way as CH0.

7. Saving Parameters

Click **OK** button to save the configured parameters.

8. Ladder Programming

Create a ladder program to control the PID module.

Ladder Program Example

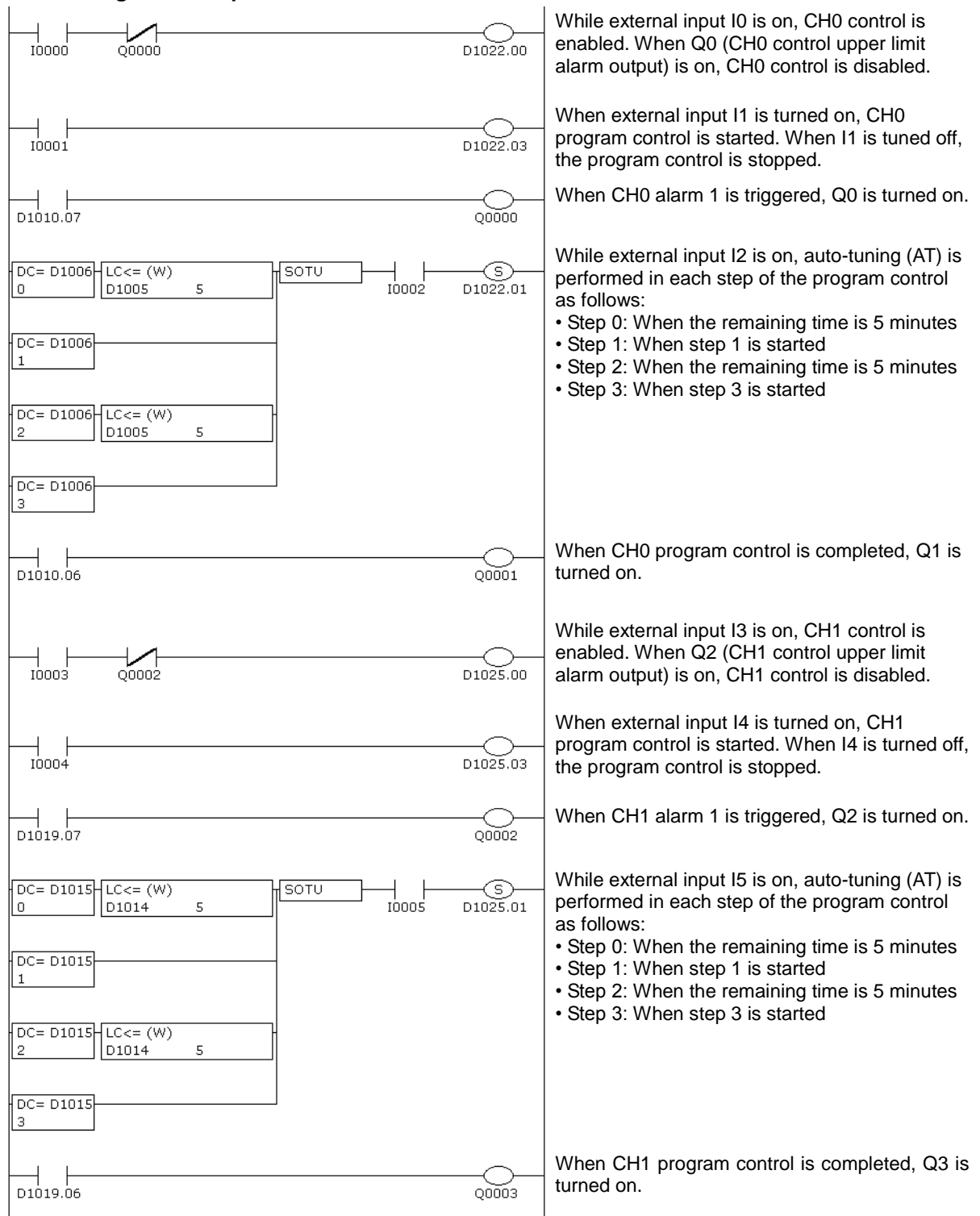

Notes:

- The ladder program should be customized depending on actual applications.
- Perform the auto-tuning (AT) near the set point (SP). If auto-tuning (AT) is performed near the ambient temperature, temperature fluctuation cannot be given to the process. In such case, the auto-tuning (AT) may not finish normally.
- Once auto-tuning (AT) is performed, it is unnecessary to perform auto-tuning (AT) again as long as the process is unchanged.

9. User Program Download

From the WindLDR menu bar, select **Online > Transfer > Download** to open Download dialog box. Click the check box on the left of **Write PID Module parameters after download** and click **OK** button. The user program will be downloaded to the CPU module. After downloading the user program, the PID module parameters will be written to the data registers in the CPU module and the PID module connected to the CPU module.

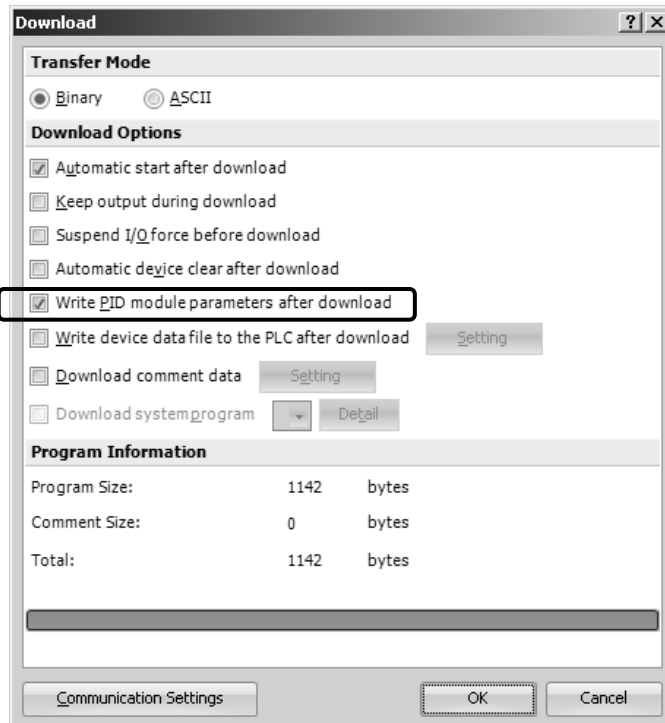

When program download is successfully completed, the following message will appear. Click **OK** button to close the message.

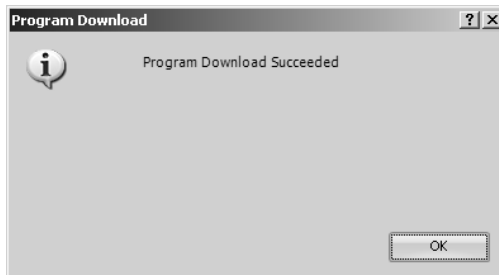

10. Starting Program Control

1. Turn on external input I0 and I3 to enable CH0 and CH1 controls.
2. Turn on external input I2 and I5 to allow auto-tuning (AT) to be performed.
3. Turn on external input I1 and I4 to start the program control for CH0 and CH1 controls.
4. Turn on the load circuit power.

The PID module starts the configured program control from step 0. Auto-tuning (AT) will be performed in each step. When the program control for CH0 or CH1 is completed, Q1 or Q3 will be turned on, respectively.

Application Example 3

This application example demonstrates the heating/cooling control for a system using an electric furnace. The set point (SP) of CH0 control is 200.0°C.

- PID control is performed based on the process variable (PV) of CH0 control. The heating output and cooling output is turned on or off in accordance with heating output manipulated variable (MV) and cooling output manipulated variable (MV).
- PID parameters (proportional band/proportional gain, integral time, derivative time, and ARW) are automatically calculated using auto-tuning (AT).
- If the process variable (PV) of CH0 control becomes out of the range between 194.5°C and 205.5°C, the upper/lower limits alarm output (Q0) is turned on and the control is disabled.

System Configuration and Wiring

Wiring Example of the FC5A-F2M2 [Non-contact voltage output (for SSR drive)/current output type]

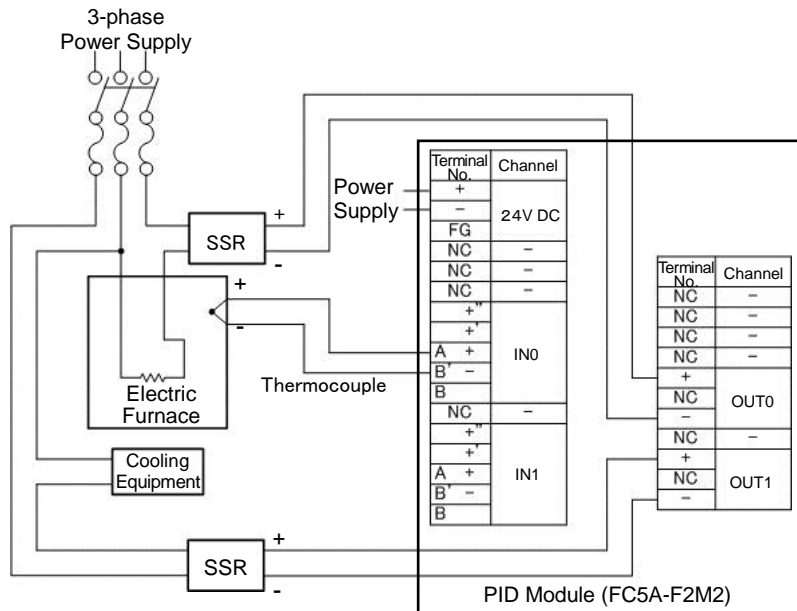

PID Module Parameter Configuration

The parameters of the PID module can be configured in the Expansion Modules Configuration and PID Module Configuration dialog boxes. The procedure to configure the PID module is described below.

Parameter Configuration Example

Quantity of Modules: 1 unit

Slot No.: Slot 1

Module Type No.: FC5A-F2M2

Data Register: D1000

Internal Relay: M1000

I/O Function: Used as a heating/cooling control PID module

	CH0	CH1
Input	Type K thermocouple with a decimal point (0.0 to 400.0)°C	—
Output	Non-contact voltage output (for SSR drive)	Non-contact voltage output (for SSR drive)
Alarm 1 Type	Upper/Lower limits alarm with standby	—
Alarm 1 Value	5.5°C	—
Set Point (SP)	200.0°C	—
Control Action	PID control action [P, I, D, and ARW are automatically calculated using auto-tuning (AT).]	—
AT Bias	20.0°C	—

Parameter Configuration Procedure

1. Expansion Modules Configuration

Select **Configuration > Expansion Modules** from the WindLDR menu bar to open the Expansion Modules Configuration dialog box.

In the Expansion Modules Configuration dialog, configure the quantity of modules, slot number, module type No., control register (data register) and control relay (internal relay). Click on **Configure Parameters** button to open the PID Module Configuration dialog box.

Expansion Modules Configuration Dialog Box

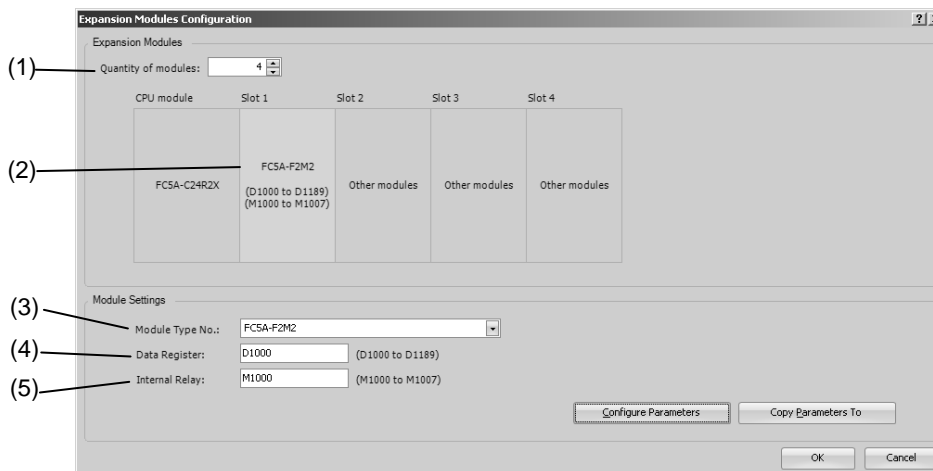

	Item	Setting
(1)	Quantity of Modules	1
(2)	Slot No.	Slot 1
(3)	Module Type No.	FC5A-F2M2
(4)	Data Register	D1000
(5)	Internal Relay	M1000

2. I/O Function Selection

Select I/O function for each channel in the PID Module Configuration dialog box.

PID Module Configuration Dialog Box (I/O Function Selection)

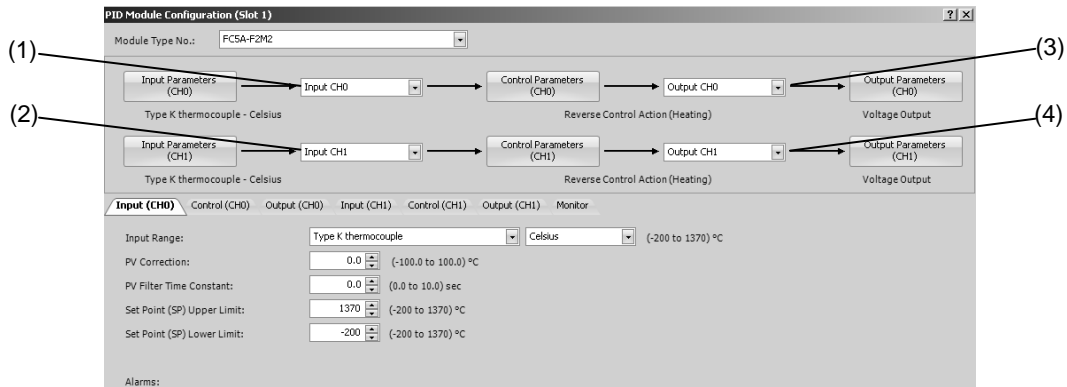

	Item	Setting
(1)	Input CH0 Function	Input CH0
(2)	Input CH1 Function	Input CH1
(3)	Output CH0 Function	Output CH0
(4)	Output CH1 Function	Output CH1

3. Input CH0 Parameters

Configure the Input CH0 parameters in the PID Module Configuration dialog box. To open Input CH0 Parameters in the PID Module Configuration dialog box, click on **Input Parameters (CH0)** button or **Input (CH0)** tab.

PID Module Configuration Dialog Box (Input CH0 Parameters)

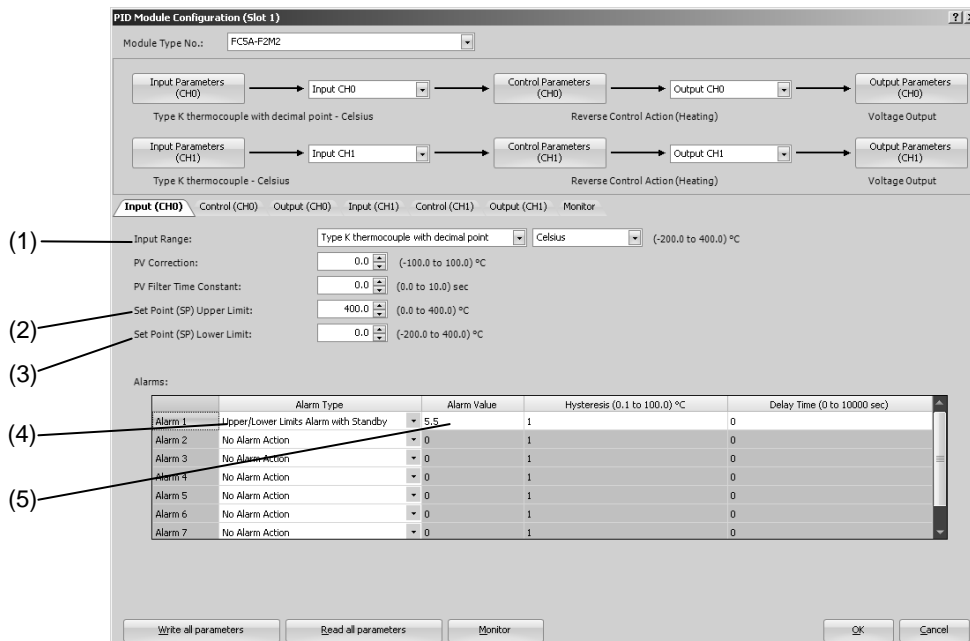

	Item	Setting
(1)	Input Range	Type K thermocouple with decimal point, Celsius
(2)	Set Point (SP) Upper Limit	400.0°C
(3)	Set Point (SP) Lower Limit	0.0°C
(4)	Alarm 1 Type	Upper/Lower limits alarm with standby
(5)	Alarm 1 Value	5.5°C

4. Control CH0 Parameters

Configure the Control CH0 parameters in the PID Module Configuration dialog box. To open Control CH0 Parameters in the PID Module Configuration dialog box, click on **Control Parameters (CH0)** button or **Control (CH0)** tab.

PID Module Configuration Dialog Box (Control CH0 Parameters)

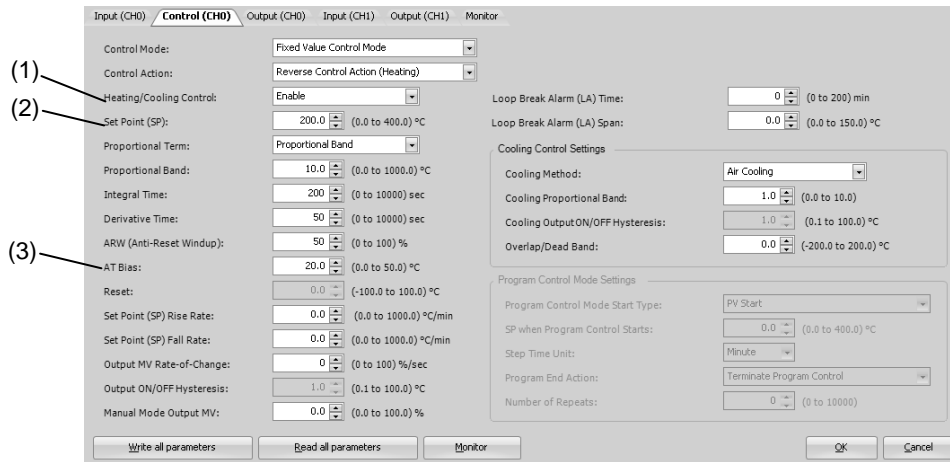

	Item	Setting
(1)	Heating/Cooling Control	Enable
(2)	Set Point (SP)	200.0°C
(3)	AT Bias	20.0°C

5. Saving Parameters

Click **OK** button to save the configured parameters.

6. Ladder Programming

Create a ladder program for heating/cooling control of the PID module.

Ladder Program Example

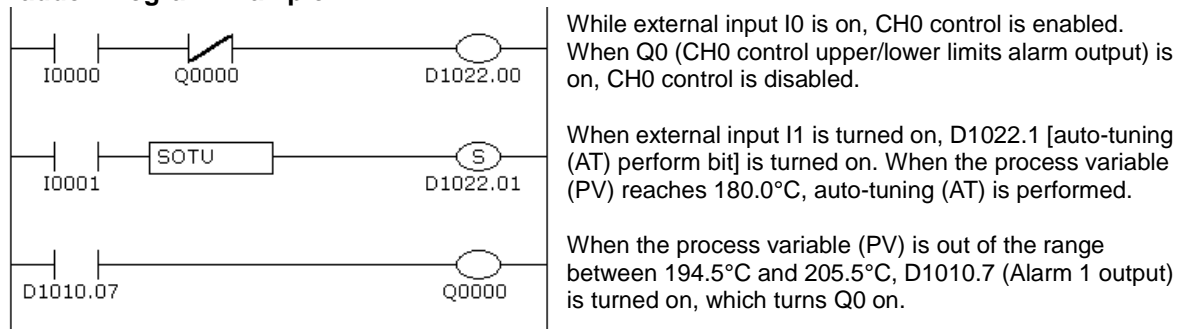

Notes:

- The temperature at which Auto-tuning (AT) is performed is determined by the set point (SP) and AT bias. In the above example, auto-tuning (AT) will be performed when the process variable (PV) reaches 180.0°C
- When upper/lower limits alarm with standby is selected as the alarm type, the alarm is not activated until the process variable (PV) enters the alarm output OFF range (194.5°C to 205.5°C). Once the process variable (PV) enters the alarm output OFF range, the standby is cancelled and the alarm is activated.
- The ladder program should be customized depending on actual applications.

7. User Program Download

From the WindLDR menu bar, select **Online > Transfer > Download** to open Download dialog box. Click the check box on the left of **Write PID Module parameters after download** and click **OK** button. The user program will be downloaded to the CPU module. After downloading the user program, the PID module parameters will be written to the data registers in the CPU module and the PID module connected to the CPU module.

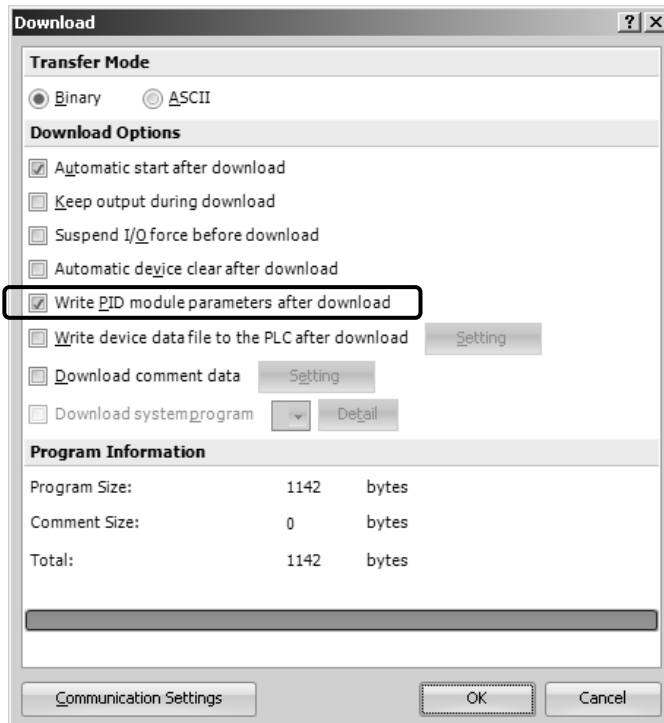

When program download is successfully completed, the following message will appear. Click **OK** button to close the message.

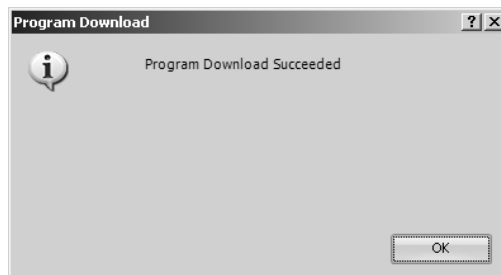

8. Starting Heating/Cooling Control

1. Confirm that 2000 is stored in D1020 of CPU module.
2. Turn on the external input I0 to enable CH0 control.
3. Turn on the load circuit power.

The PID module starts the heating/cooling control action to keep the temperature of the control target at the set point (SP). Turn on I1 to perform the auto-tuning (AT) for CH0 control whenever necessary (see pages 4-6 to 4-8).

8: TROUBLESHOOTING

This chapter describes the countermeasures when any errors or problems occur while operating the PID module. If any problem occurs, take actions described in the flowchart corresponding to the problem.

The PID Module Power LED (PWR) is OFF or Flashing.

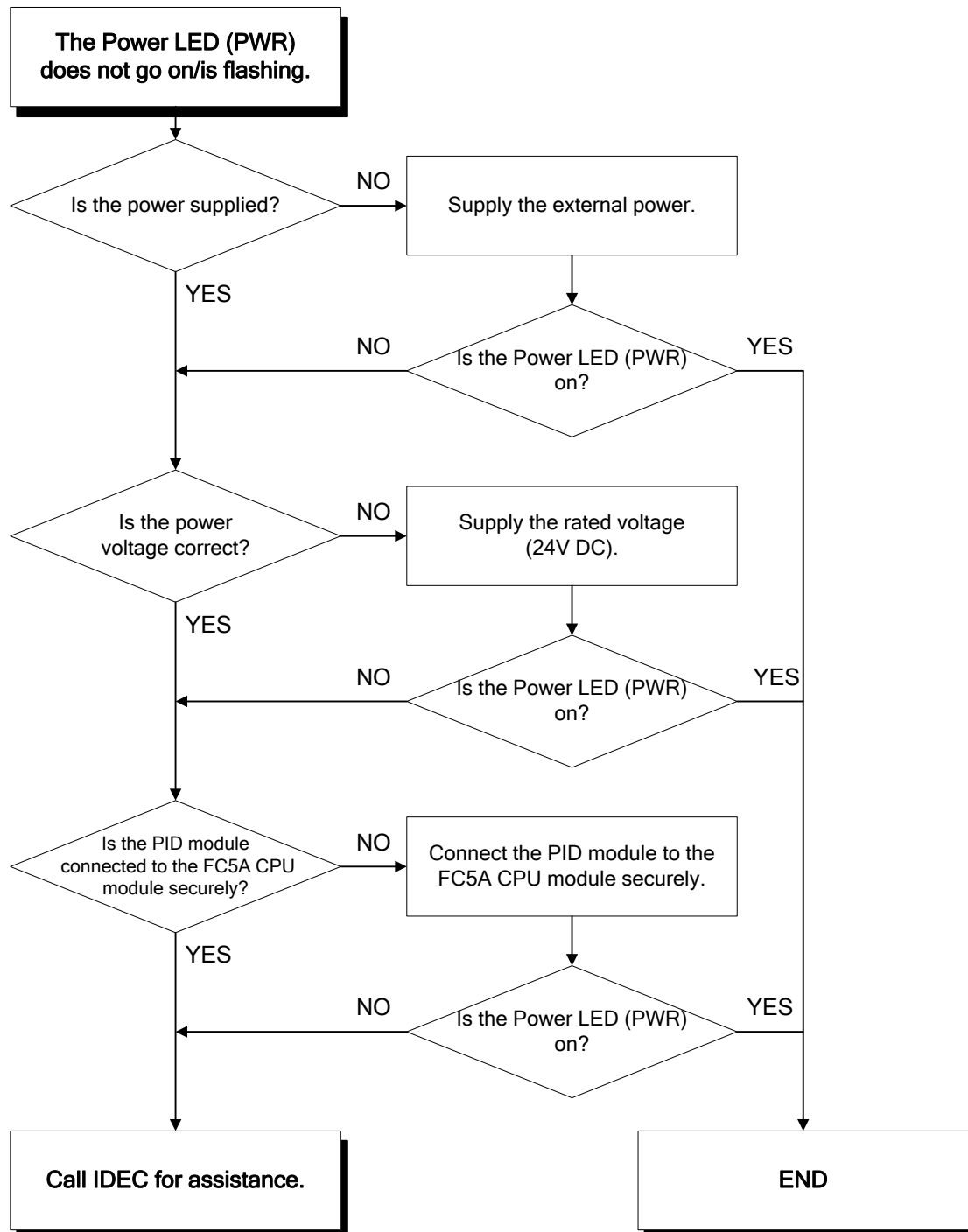

The PID Module output does not operate normally.

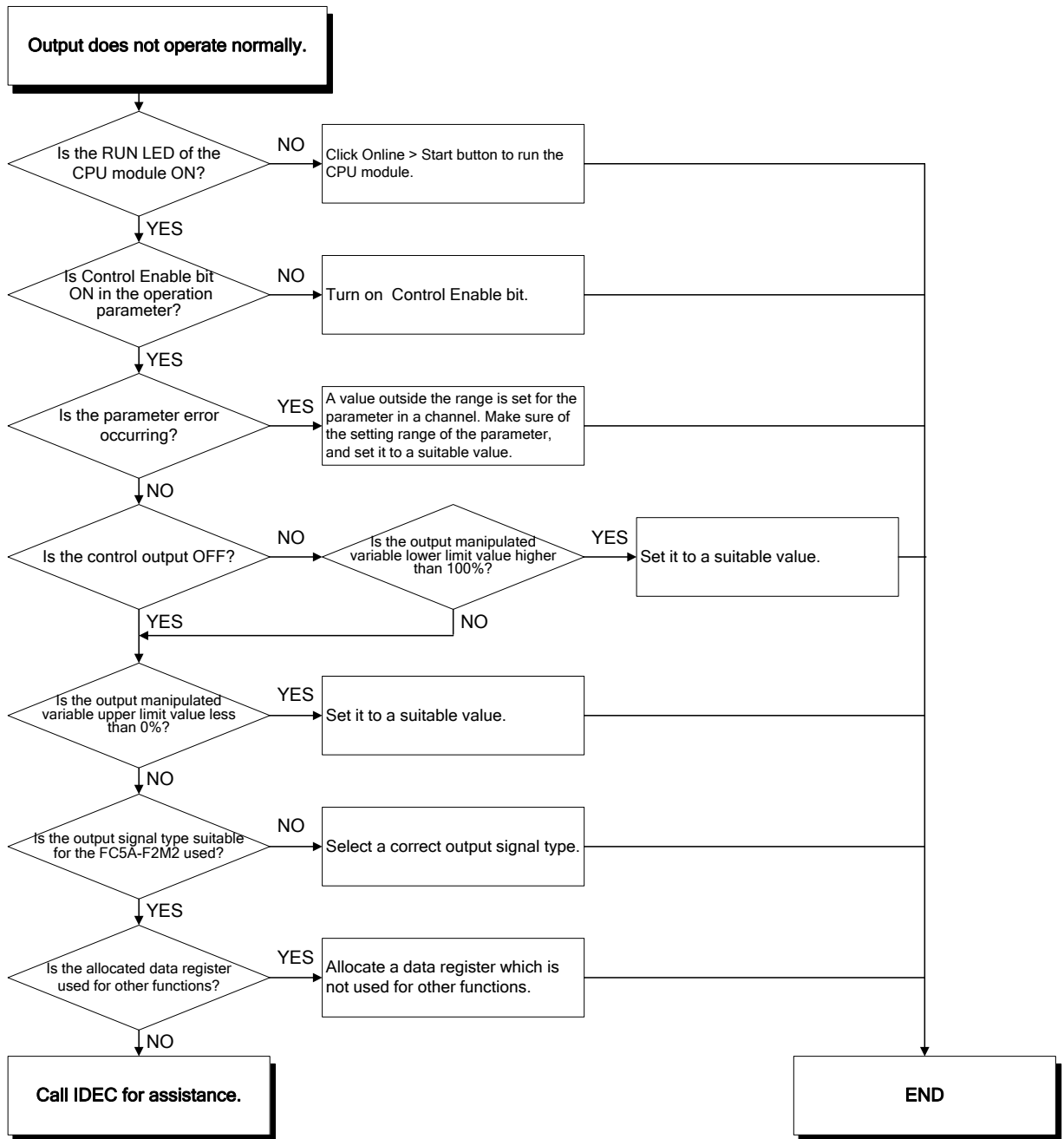

Hunting phenomenon is occurring while in ON/OFF control action

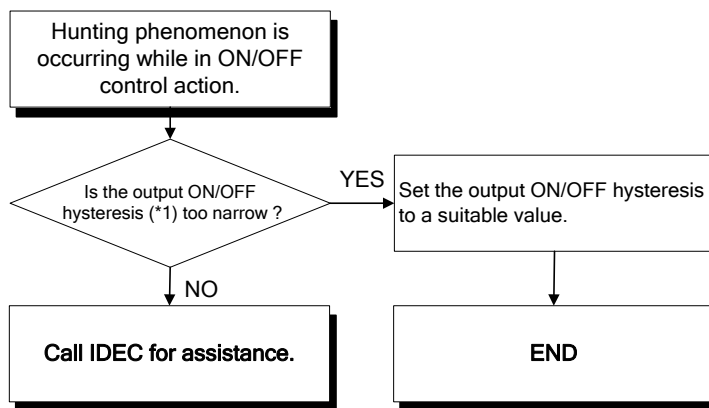

*1: For detail about the output ON/OFF hysteresis, see page 6-38.

Hunting phenomenon is occurring while in PID, PI, PD, or P control action

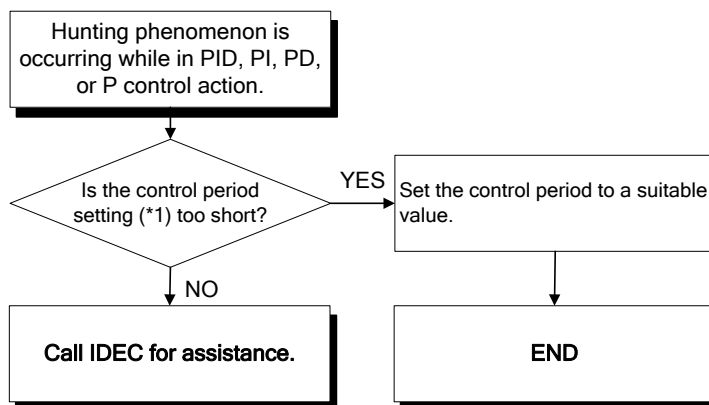

*1: For detail about the control period, see page 6-46.

The PID Module input does not operate normally.

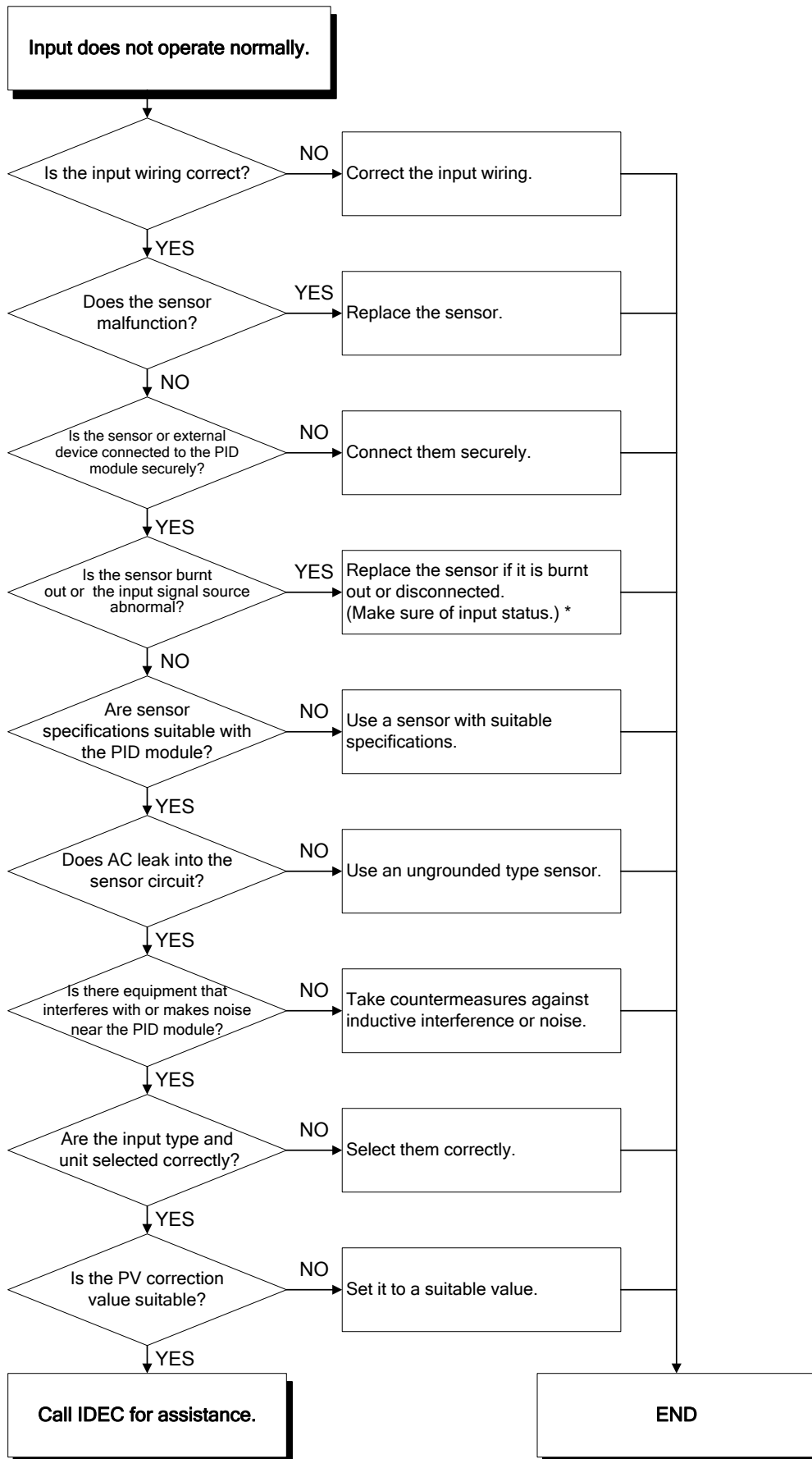

*1: Refer to "Input Status Checking" on page 8-5.

Input Status Checking

Sensor may be burnt out if any of the following problems occur.

- (1) Operating status over range flag remains ON.
- (2) Operating status under range flag remains ON.
- (3) Input value constantly shows 0mA or 0V.

Please make sure these conditions are checked thoroughly and take the appropriate action.

(1) Operating status over range flag remains ON.

Checking Items	Action
Is thermocouple or resistance thermometer burnt out? Is voltage input (0 to 1V DC) disconnected?	Replace sensor. [How to check sensor burn out or voltage disconnection] [Thermocouple] Short the input terminals of the PID module. If a value around room temperature is indicated, the PID module is operating normally and the sensor may be burnt out. [Resistance thermometer] Connect approx. 100Ω resistor between the input terminals A and B, and short the input terminals B and B of the PID module. If a value around 0°C (32°F) is indicated, the PID module is operating normally and the sensor may be burnt out. [Voltage (0 to 1V DC)] Short the input terminals of the PID module. If a linear conversion minimum value is indicated, the PID module is operating normally and the signal wire may be disconnected.

(2) Operating status under range flag remains ON.

Checking Items	Action
Does the input signal source for voltage (1 to 5V DC) or current (4 to 20mA) operate normally?	Check the input signal source for voltage (1 to 5V DC) or current (4 to 20mA). [How to check whether the input signal wire is disconnected] [Voltage (1 to 5V DC)] Input 1V DC to the input terminals of the PID module. If a linear conversion minimum value is indicated, the PID module is operating normally and the signal wire may be disconnected. [Current (4 to 20mA)] Input 4mA to the input terminals of the PID module. If a linear conversion minimum value is indicated, the PID module is operating normally and the signal wire may be disconnected.

(3) The process variable (PV) constantly shows the linear conversion minimum value.

Checking Items	Action
Does the input signal source for voltage (0 to 5V DC, 0 to 10V DC) or current (0 to 20mA) operate normally?	Check input signal source for voltage (0 to 5V DC or 0 to 10V DC) or current (0 to 20mA). [How to check whether the input signal wire is disconnected] [Voltage (0 to 5V DC or 0 to 10V DC)] Input 1V DC to the input terminals of the PID module. If a converted value, calculated with the linear conversion minimum and maximum values, corresponding to 1V DC is indicated, the PID module is operating normally and the signal wire may be disconnected. [Current (0 to 20mA)] Input 4mA to the input terminals of the PID module. If a converted value, calculated with the linear conversion minimum and maximum values, corresponding to 4mA is indicated, the PID module is operating normally and the signal wire may be disconnected.

Loop break alarm turns on even though the actuator operates normally.

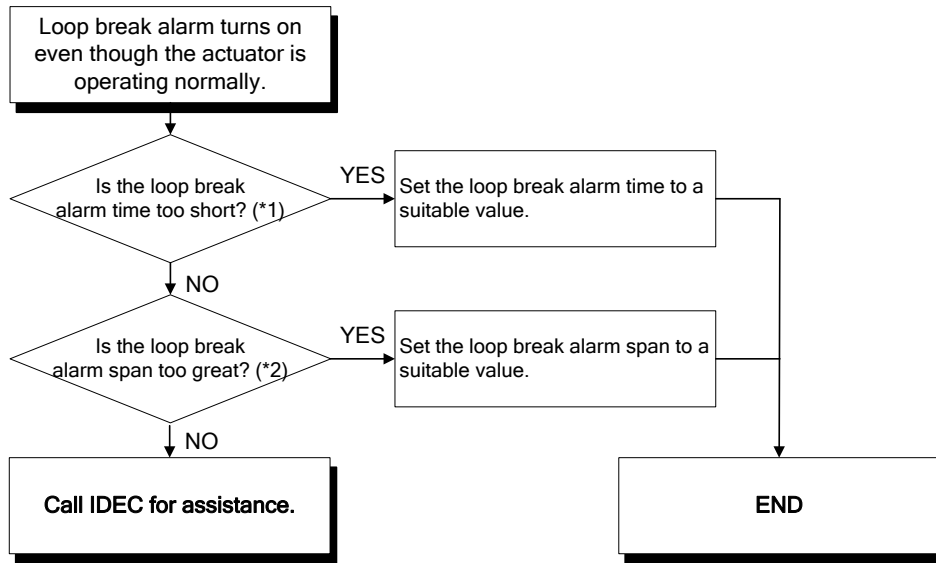

*1: Loop break alarm time may be too short compared to the loop break alarm span.
 *2: Loop break alarm span may be too great compared to the loop break alarm time.

Note: Loop break alarm time and loop break alarm span

Set the loop break alarm span to a value around 1.25 times bigger than the operation span in normal operation.

Example: Heater in which temperature rises 150°C in 30 minutes

When the loop break alarm time is 10 minutes, the operation span in normal operation is 50°C (150°C/30 minutes × 10 minutes). Set the loop break alarm span to 65°C which is about 1.25 times bigger than 50°C.

Program control is terminated earlier than the configured time.

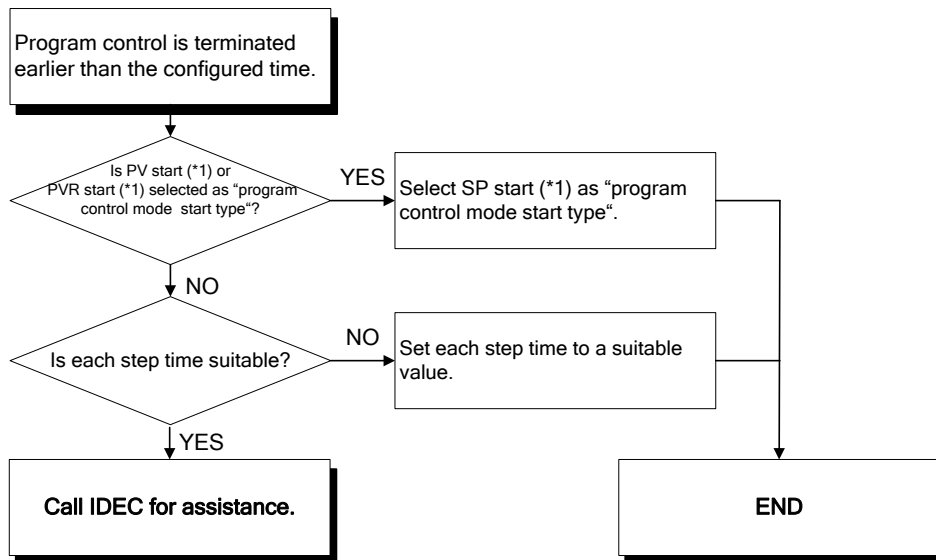

*1: For program control mode start type, see page 6-41.

9: APPENDIX

This chapter describes the function references, output actions, and factory default settings of the PID module.

PID Module Function References

Control Action	PID control [with auto-tuning (AT)] PI control PD control (with auto-reset) P control (with auto-reset) ON/OFF control	
	Proportional term (P)	Proportional band: When input range unit is Celsius: 0 to 10000°C (Range with a decimal point: 0.0 to 1000.0°C) When input range unit is Fahrenheit: 0 to 10000°F (Range with a decimal point: 0.0 to 1000.0°F) When input is voltage/current: 0.0 to 1000.0% Proportional gain: 0.00 to 100.00% Note: The control action will be ON/OFF control when proportional term is 0.
	Integral time (I)	0 to 10000 seconds
	Derivative time (D)	0 to 10000 seconds
	Control period	1 to 120 seconds
	ARW	0 to 100%
	Reset	When input range unit is Celsius: -100.0 to 100.0°C When input range unit is Fahrenheit: -100.0 to 100.0°F When input is voltage/current: -1000 to 1000
	Output ON/OFF hysteresis	When input range unit is Celsius: 0.1 to 100.0°C When input range unit is Fahrenheit: 0.1 to 100.0°F When input is voltage/current: 1 to 1000
Alarm	Output manipulated variable (MV) upper limit, lower limit	When output type is relay or voltage: Upper limit: Output manipulated variable lower limit value to 100% Lower limit: 0 to output manipulated variable upper limit value When output type is current: Upper limit: Output manipulated variable lower limit value to 105% Lower limit: -5 to output manipulated variable upper limit value
	Output manipulated variable rate-of-change	0 to 100%/sec
	The alarm range can be configured with the alarm value. When the process variable (PV) goes outside of the range, the alarm output turns on or off. Alarm type can be selected from upper limit alarm, lower limit alarm, upper/lower limits alarm, upper/lower limit range alarm, process low alarm, process high alarm, upper limit alarm with standby, lower limit alarm with standby, upper/lower limits alarm with standby, and no alarm action. For details about the alarm, see pages 6-26 to 6-28.	
	Setting accuracy	Same with input error (See page 2-4)
	Action	ON/OFF action
	Hysteresis	When input is thermocouple or resistance thermometer: 0.1 to 100.0°C (°F) When input is voltage/current: 1 to 1000
	Output	Operating status (See page 5-9)
	Alarm Delay time	0 to 10000 seconds

Loop Break Alarm	A trouble of the actuator, such as heater break or heater adhesion, can be detected as the loop break alarm. For details about the loop break alarm, see page 6-39.	
	Loop break alarm time	0 to 200 minutes
	Loop break alarm span	When input is thermocouple or resistance thermometer: 0 to 150°C (°F) or 0.0 to 150.0°C (°F) When input is voltage/current: 0 to 1500
	Output	Bit 2 of the operating status
Set Point (SP) Ramp Function	When the set point (SP) is changed, the set point (SP) is gradually increased from the original set point (SP) to the new set point (SP) according to the configured rate-of-change (°C/minute, °F/minute). When the control is started, the set point (SP) is increased from the current process variable (PV) to the configured set point (SP) according to the configured rate-of-change (°C/minute, °F/minute).	
Auto/Manual Mode Switching	Auto or manual mode can be switched. When the control mode is switched from auto to manual mode and vice versa, the balanceless-bumpless function works to prevent a sudden change in output manipulated variable (MV). When the power is turned on, the operation parameters in Block 1 are retained, so the control action starts with the previous mode at the time of power off.	
Cascade Control	The cascade control is an advanced control that uses 2 inputs [CH1 as a master (primary control) and CH0 as a slave (secondary control)] to control one process. The output manipulated variable (MV) calculated according to the process variable (PV) and the set point (SP) of the master (CH1) is used as the set point (SP) of the slave (CH0) for control. The control results will be outputted from the output CH0.	
Heating/Cooling Control Output (CH0 only)	When it is difficult to control the target process with heating control only, cooling control can be added to perform the heating/cooling control.	
	Cooling proportional band	0.0 to 10.0 times. Cooling proportional band is the product of this value and the heating proportional band. The cooling control becomes ON/OFF control when the cooling proportional band is 0.
	Integral time (I)	0 to 10000 seconds
	Derivative time (D)	0 to 10000 seconds
	Cooling control period	1 to 120 sec
	Overlap/Dead band	When input is thermocouple/RTD: -200.0 to 200.0°C (°F) When input is voltage/current: -2000 to 2000
	Cooling output ON/OFF hysteresis	When input is thermocouple/RTD: 0.1 to 100.0°C (°F) When input is voltage/current input: 1 to 1000
	Cooling output manipulated variable (MV) upper limit, lower limit	When output type is voltage: Upper limit: Cooling output manipulated variable lower limit to 100% Lower limit: 0% to cooling output manipulated variable upper limit When output type is current: Upper limit: Cooling output manipulated variable lower limit to 105% Lower limit: -5% to cooling output manipulated variable upper limit
	Cooling method	Air cooling (Linear characteristic), Oil cooling (1.5th power of the linear characteristic), or Water cooling (2nd power of the linear characteristic)
Cooling output	CH1 output.	
External SP Input	The input value of input CH1 is used as the set point (SP) of CH0 control. When the external SP input bias is configured, it is added to the set point (SP) of CH0 control. The input types that can be selected are shown in the following table.	
	Input type	Current: 4 to 20mA or 0 to 20mA Voltage: 1 to 5V or 0 to 1V
	Allowable input	Current: 50mA DC maximum Voltage (0 to 1V): 5V DC maximum Voltage (1 to 5V): 10V DC maximum
	Input impedance	Current: 50Ω Voltage: 100kΩ

Wait Function	During the program control running, when a step is finished, the program control does not proceed to the next step until the deviation between the process variable (PV) and set point (SP) becomes less than the wait value.	
Program Hold	During the program control running, when the program control is held, the progression of the program control is suspended. While the program control is held, the fixed value control is performed with the set point (SP) at the hold point.	
Advance Next Step	During the program control running, when the advance next step bit is turned on, the current step is terminated, and the program control is proceeded to the next step.	
Advance Previous Step	During the program control running, when the advance previous step bit is turned on, the progression of the program control is moved back. If the elapsed time in the current step is less than 1 minute, the program control goes back to the start of the previous step. If the elapsed time in the current step is more than or equal to 1 minute, the program control goes back to the start of the current step. Even when the advance previous function is executed at Step 0, the program control does not move back to Step 9 regardless of the program end action.	
Repeat Function	When the program control is terminated, the program control can be repeated from step 0 as many times as the number of repeats configured.	
Program End Action	The action to be taken when the program control is terminated can be selected.	
	Terminate program control	When the program control is terminated, the program end output bit is turned on and maintained, and the PID module will be in standby status. The program control can be executed again by turning off to on the program control bit (operation parameter bit3). During the program control standby (waiting for program control run) status, the control output is turned off, and the operating status is not updated except the over range, the under range, and the program end output.
	Continue program control (Repeat)	When the program control is terminated, the program control is repeated from step 0 as many times as the configured number of repeats. When the step 9 of the last program control cycle is performed and finished, the program end output bit is turned on and maintained.
	Hold program control	When the program control is terminated, the program control is held at the last status of step 9. The program end output and program hold bit are turned on and maintained. While the program control is held, the fixed value control is performed with the set point (SP) of step 9. If advance next function (operation parameter Bit6 is turned off to on) is executed while the program control is held, the program control is started again from step 0. The program end output and program hold bit are turned off. While the program control is being held, the parameters of Blocks 10 to 19 and 30 to 39 can be changed. The program control can be executed again after changing the program parameters, such as the set point (SP) or step time of each step.
External PV Mode	When the external PV mode is enabled, the PID module performs PID control with the process variable given by the CPU module. The process variable with decimal point (PV1) of the control target can be used to calculate the process variable using the ladder program in the CPU module.	

Output Manipulated Variable (MV) Rate-of-Change	The maximum change of the output manipulated variable in one second can be configured.
PV Correction	<p>If the sensor cannot be installed to the location of the control target, the temperature measured by the sensor may deviate from the actual temperature of the control target. When a target is controlled with multiple PID modules, the measured temperatures may not match due to the differences in sensor accuracy or dispersion of load capacities even though the set points (SP) of those PID modules are the same. In such cases, the process variable (PV) of the PID module can be adjusted to the desired temperature by using the PV Correction. The process variable (PV) after PV correction is added should be within the control range.</p> <p>The process variable (PV) after PV correction can be calculated using the following formula: Process variable (PV) after PV correction = Process variable (PV) + (PV correction value)</p> <p>PV Correction Range: When input is thermocouple or resistance thermometer: 0.1 to 100.0°C (°F) When input is voltage/current: 1 to 1000</p>
PV Filter Time Constant	The PV filter function is a software filter to stabilize the process variable (PV) affected by fluctuating processes, such as pressure or flow rate, by calculating first-order lag of the process variable (PV).
Automatic Cold Junction Temperature Compensation	The PID module measures the temperature at the input terminal and maintains the reference junction as if the reference junction was at 0°C or 32°F
Burnout (Over Range)	When thermocouple input or resistance thermometer input is burnt out, the over range bit of the operating status is turned on, and control output is turned off (when output type is current, the output manipulated variable lower limit value is outputted).
Control Range	<p>When input is thermocouple: Input range lower limit -50°C (100°F) to Input range +50°C (100°F) Range with a decimal point: -(Full scale x 1%)°C (°F) to Input range +50°C (100°F)</p> <p>When input is resistance thermometer: -(Full scale x 1%)°C (°F) to Input range +50°C (100°F)</p> <p>When input is voltage/current: Linear conversion minimum value -(1% of linear conversion span) to Linear conversion maximum value +(10% of linear conversion span)</p>
PID Module Standby	<p>When the power is turned on, the PID module starts with the standby status. During the standby, the control and alarm assessment are not conducted.</p> <p>The control and alarm assessment are enabled when the control enable bit of the operation parameters is turned on.</p> <p>When the control mode is the program control and the power is restored, the PID module resumes with the status at the time of the power failure.</p>

Output Action

CH0, CH1 Output Action of PID, PI, PD, and P Control Action

	Heating (Reverse) Control Action	Cooling (Direct) Control Action
Control Action		
Relay Output	<p>Cycle Action is Performed According to Deviation.</p>	<p>Cycle Action is Performed According to Deviation.</p>
Non-contact Voltage Output	<p>Cycle Action is Performed According to Deviation.</p>	<p>Cycle Action is Performed According to Deviation.</p>
Current Output	<p>Changes Continuously According to Deviation.</p>	<p>Changes Continuously According to Deviation.</p>
LED Indicator CH0 OUT Green		

: Turns ON or OFF.

CH0, CH1 Output Action of ON/OFF Control Action

	Heating (Reverse) Control Action	Cooling (Direct) Control Action
Control Action		
Relay Output		
Non-contact Voltage Output		
Current Output		
LED Indicator CH0 OUT Green		

: Turns ON or OFF.

Output Action of Heating/Cooling Control

Control Action			
CH0 Relay Output	<p>Cycle Action is Performed According to Deviation.</p>		
CH1 Relay Output	<p>Cycle Action is Performed According to Deviation.</p>		
CH0 Non-contact Voltage Output	<p>Cycle Action is Performed According to Deviation.</p>		
CH1 Non-contact Voltage Output	<p>Cycle Action is Performed According to Deviation.</p>		
CH0 Current Output	<p>Changes Continuously According to Deviation.</p>		
CH1 Current Output	<p>Changes Continuously According to Deviation.</p>		
LED Indicator CH0 OUT Green			
LED Indicator CH1 OUT Green			

- : Turns ON or OFF.
- : Represents heating control action.
- : Represents cooling control action.

Output Action of Heating/Cooling Control with Overlap

<p>Control Action</p>			
<p>CH0 Relay Output</p>	<p>Cycle Action is Performed According to Deviation.</p>		
<p>CH1 Relay Output</p>	<p>Cycle Action is Performed According to Deviation.</p>		
<p>CH0 Non-contact Voltage Output</p>	<p>Cycle Action is Performed According to Deviation.</p>		
<p>CH1 Non-contact Voltage Output</p>	<p>Cycle Action is Performed According to Deviation.</p>		
<p>CH0 Current Output</p>	<p>Changes Continuously According to Deviation.</p>		
<p>CH1 Current Output</p>	<p>Changes Continuously According to Deviation.</p>		
<p>LED Indicator CH0 OUT Green</p>			
<p>LED Indicator CH1 OUT Green</p>			

- : Turns ON or OFF.
- : Represents heating control action.
- : Represents cooling control action.

Output Action of Heating/Cooling Control with Dead Band

Control Action			
CH0 Relay Output			
CH1 Relay Output			
CH0 Non-contact Voltage Output			
CH1 Non-contact Voltage Output			
CH0 Current Output			
CH1 Current Output			
LED Indicator CH0 OUT Green			
LED Indicator CH1 OUT Green			

- : Turns ON or OFF.
- : Represents heating control action.
- : Represents cooling control action.

Factory Default Settings of the PID Module

The factory default settings of the parameters of each block are described. Values indicated in parentheses are stored in the data registers allocated to each block.

Block 1 Write Only Parameters

Offset from the Control Register		Parameter	Default Value
CH0	CH1		
+20	+23	Set Point (SP)	0°C (0)
+21	+24	Manual Mode Output Manipulated Variable (External PV mode disabled)	0% (0)
+22	+25	Operation Parameter *1	0

*1: For details about the operation parameter, see page 5-10.

Blocks 2, 3 Basic Parameters

Offset from the Control Register		Parameter	Default Value
CH0	CH1		
+26	+103	Proportional Term	Proportional band: 10°C (10)
+27	+104	Integral Time	200 sec (200)
+28	+105	Derivative Time	50 sec (50)
+29	+106	ARW (Anti-Reset Windup)	50% (50)
+30	+107	Control Period	FC5A-F2MR2 (Relay output): 30 sec (30) FC5A-F2M2 (Non-contact voltage output): 3 sec (3)
+31	+108	Reset	0.0°C (0)
+32	+109	Output Manipulated Variable Rate-of-Change	0%/second (0)
+33	+110	Set Point (SP) Rise Rate	0°C/minute (0)
+34	+111	Set Point (SP) Fall Rate	0°C/minute (0)
+35	+112	Loop Break Alarm (LA) Time	0 minutes (0)
+36	+113	Loop Break Alarm (LA) Span	0°C (0)
+37	+114	Alarm 1 Value	0°C (0)
+38	+115	Alarm 2 Value	
+39	+116	Alarm 3 Value	
+40	+117	Alarm 4 Value	
+41	+118	Alarm 5 Value	
+42	+119	Alarm 6 Value	
+43	+120	Alarm 7 Value	
+44	+121	Alarm 8 Value	
+45	+122	Reserved	0
+46	+123	Output Manipulated Variable Upper Limit	100% (100)
+47	+124	Output Manipulated Variable Lower Limit	0% (0)
+48	+125	Cooling Proportional Band (CH0 only)	[CH0] 1.0 times (10) [CH1] 0
+49	+126	Cooling Control Period (CH0 only)	[CH0] FC5A-F2MR2 (Relay output): 30 sec (30) FC5A-F2M2 (Non-contact voltage output): 3 sec (3) [CH1] 0
+50	+127	Overlap/Dead Band (CH0 only)	[CH0] 0.0°C (0) [CH1] 0
+51	+128	Cooling Output Manipulated Variable Upper Limit (CH0 only)	[CH0] 100% (100) [CH1] 0
+52	+129	Cooling Output Manipulated Variable Lower Limit (CH0 only)	[CH0] 0% (0) [CH1] 0

Blocks 4, 5 Initial Setting Parameters

Offset from the Control Register		Parameter	Default Value
CH0	CH1		
+53	+130	Control Action	0: Reverse action (Heating)
+54	+131	Heating/Cooling Control (CH0 only)	[CH0] 0: Disable [CH1] 0
+55	+132	External SP Input (CH0 only)	[CH0] 0: Disable [CH1] 0
+56	+133	Input Function	[CH0/CH1] 0: Input (CH0/CH1)
+57	–	Output Function (CH0)	[CH0] 0: Output (CH0)
–	+134	Output Function (CH1)	[CH1] 0: Output (CH1)
+58	+135	Input Type	00h: Type K thermocouple -200 to 1370°C
+59	+136	Set Point (SP) Upper Limit/Linear Conversion Maximum Value	1370°C (1370)
+60	+137	Set Point (SP) Lower Limit/Linear Conversion Minimum Value	-200°C (-200)
+61	+138	Output ON/OFF Hysteresis	1.0°C (10)
+62	+139	PV Correction	0.0°C (0)
+63	+140	PV Filter Time Constant	0.0 seconds (0)
+64	+141	Reserved	0
+65	+142	Alarm 1 Type	0: No alarm action
+66	+143	Alarm 2 Type	
+67	+144	Alarm 3 Type	
+68	+145	Alarm 4 Type	
+69	+146	Alarm 5 Type	
+70	+147	Alarm 6 Type	
+71	+148	Alarm 7 Type	
+72	+149	Alarm 8 Type	
+73	+150	Alarm 1 Hysteresis	1.0°C (10)
+74	+151	Alarm 2 Hysteresis	
+75	+152	Alarm 3 Hysteresis	
+76	+153	Alarm 4 Hysteresis	
+77	+154	Alarm 5 Hysteresis	
+78	+155	Alarm 6 Hysteresis	
+79	+156	Alarm 7 Hysteresis	
+80	+157	Alarm 8 Hysteresis	
+81	+158	Alarm 1 Delay Time	0.0 seconds (0)
+82	+159	Alarm 2 Delay Time	
+83	+160	Alarm 3 Delay Time	
+84	+161	Alarm 4 Delay Time	
+85	+162	Alarm 5 Delay Time	
+86	+163	Alarm 6 Delay Time	
+87	+164	Alarm 7 Delay Time	
+88	+165	Alarm 8 Delay Time	
+89	+166	AT Bias	20°C (20)
+90	+167	Control Mode	0: Fixed value control
+91	+168	Program Control Mode Start Type	0: PV start
+92	+169	Step Time Unit	0: Minute
+93	+170	Program End Action	0: Terminate program control
+94	+171	Proportional Term	0: Proportional band
+95	+172	Cooling Method (CH0 only)	[CH0] 0: Air cooling [CH1] 0
+96	+173	Set Point (SP) when Program Control Starts	0.0°C (0)
+97	+174	Number of Repeats	0 times (0)
+98	+175	Cooling Output ON/OFF Hysteresis (CH0 only)	[CH0] 1.0°C (10) [CH1] 0
+99	+176	Output Specifications (FC5A-F2M2 only)	0: Non-contact voltage output (for SSR drive)
+100	+177	External SP Input Bias (CH1 only)	[CH0] 0 [CH1] 0.0°C (0)
+101	+178	External SP Input Linear Conversion Maximum Value (CH1 only)	[CH0] 0 [CH1] 1370°C (1370)
+102	+179	External SP Input Linear Conversion Minimum Value (CH1 only)	[CH0] 0 [CH1] -200°C (-200)

Blocks 10-19 CH0 Program Parameters

Offset from the Control Register					Parameter	Default Value
Step 0	Step 1	Step 2	Step 3	Step 4		
+180	+201	+222	+243	+264	Set Point (SP)	0°C (0)
+181	+202	+223	+244	+265	Step Time	0 minutes (0)
+182	+203	+224	+245	+266	Wait Value	0°C (0)
+183	+204	+225	+246	+267	Proportional Term	Proportional band: 10°C (10)
+184	+205	+226	+247	+268	Integral Time	200 sec (200)
+185	+206	+227	+248	+269	Derivative Time	50 sec (50)
+186	+207	+228	+249	+270	ARW (Anti-Reset Windup)	50% (50)
+187	+208	+229	+250	+271	Output Manipulated Variable Rate-of-Change	0%/second (0)
+188	+209	+230	+251	+272	Alarm 1 Value	0°C (0)
+189	+210	+231	+252	+273	Alarm 2 Value	
+190	+211	+232	+253	+274	Alarm 3 Value	
+191	+212	+233	+254	+275	Alarm 4 Value	
+192	+213	+234	+255	+276	Alarm 5 Value	
+193	+214	+235	+256	+277	Alarm 6 Value	
+194	+215	+236	+257	+278	Alarm 7 Value	
+195	+216	+237	+258	+279	Alarm 8 Value	
+196	+217	+238	+259	+280	Reserved	0
+197	+218	+239	+260	+281	Output Manipulated Variable Upper Limit	100% (100)
+198	+219	+240	+261	+282	Output Manipulated Variable Lower Limit	0% (0)
+199	+220	+241	+262	+283	Cooling Proportional Band	1.0 times (10)
+200	+221	+242	+263	+284	Overlap/Dead Band	0.0°C (0)

Offset from the Control Register					Parameter	Default Value
Step 5	Step 6	Step 7	Step 8	Step 9		
+285	+306	+327	+348	+369	Set Point (SP)	0°C (0)
+286	+307	+328	+349	+370	Step Time	0 minutes (0)
+287	+308	+329	+350	+371	Wait Value	0°C (0)
+288	+309	+330	+351	+372	Proportional Term	Proportional band: 10°C (10)
+289	+310	+331	+352	+373	Integral Time	200 sec (200)
+290	+311	+332	+353	+374	Derivative Time	50 sec (50)
+291	+312	+333	+354	+375	ARW (Anti-Reset Windup)	50% (50)
+292	+313	+334	+355	+376	Output Manipulated Variable Rate-of-Change	0%/second (0)
+293	+314	+335	+356	+377	Alarm 1 Value	0°C (0)
+294	+315	+336	+357	+378	Alarm 2 Value	
+295	+316	+337	+358	+379	Alarm 3 Value	
+296	+317	+338	+359	+380	Alarm 4 Value	
+297	+318	+339	+360	+381	Alarm 5 Value	
+298	+319	+340	+361	+382	Alarm 6 Value	
+299	+320	+341	+362	+383	Alarm 7 Value	
+300	+321	+342	+363	+384	Alarm 8 Value	
+301	+322	+343	+364	+385	Reserved	0
+302	+323	+344	+365	+386	Output Manipulated Variable Upper Limit	100% (100)
+303	+324	+345	+366	+387	Output Manipulated Variable Lower Limit	0% (0)
+304	+325	+346	+367	+388	Cooling Proportional Band	1.0 times (10)
+305	+326	+347	+368	+389	Overlap/Dead Band	0.0°C (0)

Blocks 30-39 CH1 Program Parameters

Offset from the Control Register					Parameter	Default Value
Step 0	Step 1	Step 2	Step 3	Step 4		
+390	+409	+428	+447	+466	Set Point (SP)	0°C (0)
+391	+410	+429	+448	+467	Step Time	0 minutes (0)
+392	+411	+430	+449	+468	Wait Value	0°C (0)
+393	+412	+431	+450	+469	Proportional Term	Proportional band: 10°C (10)
+394	+413	+432	+451	+470	Integral Time	200 sec (200)
+395	+414	+433	+452	+471	Derivative Time	50 sec (50)
+396	+415	+434	+453	+472	ARW (Anti-Reset Windup)	50% (50)
+397	+416	+435	+454	+473	Output Manipulated Variable Rate-of-Change	0%/second (0)
+398	+417	+436	+455	+474	Alarm 1 Value	0°C (0)
+399	+418	+437	+456	+475	Alarm 2 Value	
+400	+419	+438	+457	+476	Alarm 3 Value	
+401	+420	+439	+458	+477	Alarm 4 Value	
+402	+421	+440	+459	+478	Alarm 5 Value	
+403	+422	+441	+460	+479	Alarm 6 Value	
+404	+423	+442	+461	+480	Alarm 7 Value	
+405	+424	+443	+462	+481	Alarm 8 Value	
+406	+425	+444	+463	+482	Reserved	0
+407	+426	+445	+464	+483	Output Manipulated Variable Upper Limit	100% (100)
+408	+427	+446	+465	+484	Output Manipulated Variable Lower Limit	0% (0)

Offset from the Control Register					Parameter	Default Value
Step 5	Step 6	Step 7	Step 8	Step 9		
+485	+504	+523	+542	+561	Set Point (SP)	0°C (0)
+486	+505	+524	+543	+562	Step Time	0 minutes (0)
+487	+506	+525	+544	+563	Wait Value	0°C (0)
+488	+507	+526	+545	+564	Proportional Term	Proportional band: 10°C (10)
+489	+508	+527	+546	+565	Integral Time	200 sec (200)
+490	+509	+528	+547	+566	Derivative Time	50 sec (50)
+491	+510	+529	+548	+567	ARW (Anti-Reset Windup)	50% (50)
+492	+511	+530	+549	+568	Output Manipulated Variable Rate-of-Change	0%/second (0)
+493	+512	+531	+550	+569	Alarm 1 Value	0°C (0)
+494	+513	+532	+551	+570	Alarm 2 Value	
+495	+514	+533	+552	+571	Alarm 3 Value	
+496	+515	+534	+553	+572	Alarm 4 Value	
+497	+516	+535	+554	+573	Alarm 5 Value	
+498	+517	+536	+555	+574	Alarm 6 Value	
+499	+518	+537	+556	+575	Alarm 7 Value	
+500	+519	+538	+557	+576	Alarm 8 Value	
+501	+520	+539	+558	+577	Reserved	0
+502	+521	+540	+559	+578	Output Manipulated Variable Upper Limit	100% (100)
+503	+522	+541	+560	+579	Output Manipulated Variable Lower Limit	0% (0)

INDEX

- A**
- alarm 9-1
 - delay time..... 5-21, 6-31
 - hysteresis..... 5-21, 6-31
 - output..... 5-9
 - standby..... 6-30
 - type 5-20, 6-28
 - upper limit alarm..... 7-1, 7-9
 - upper/lower limits alarm with standby..... 7-18
 - valid range 5-19
 - ARW..... 5-18, 6-39
 - AT bias 4-6, 5-21, 6-39, 7-6
 - auto-reset..... 4-7, 5-8, 5-11
 - auto-tuning (AT) 5-8, 7-6
 - cancel 4-8
 - perform 4-7, 5-11
 - auto-tuning (AT)/auto-reset..... 4-6
 - LED..... 2-2
 - program example 4-8
- B**
- basic parameters 5-3, 5-18, 9-9
 - block 0 5-1, 5-7
 - block 1 5-1, 5-10, 9-9
 - blocks 10-19 5-1, 5-23, 9-11
 - blocks 2, 3 5-1, 5-18, 9-9
 - blocks 30-39 5-1, 5-25, 9-12
 - blocks 4, 5 5-1, 5-20, 9-10
 - burnout 9-4
- C**
- cascade control 4-15, 5-20, 6-24, 9-2
 - linear conversion maximum value..... 6-46
 - linear conversion minimum value 6-46
 - cold junction compensation 9-4
 - confirming system program version 1-2
 - control action 5-20, 6-37, 9-1
 - ON/OFF control action 4-3, 8-3
 - P control action 4-3
 - PD control action..... 4-5
 - PI control action 4-4
 - PID control action..... 4-5, 7-1
 - control parameters 6-14
 - details..... 6-36
 - control period 5-18, 6-48
 - control range 9-4
 - over range 5-9
 - under range 5-9
 - control register..... 5-2, 6-6
 - control relay 5-3, 6-6
 - loading initial values 5-4, 6-5
 - reading all parameters..... 5-4, 6-5
 - writing all parameters 5-4, 6-5
 - writing block..... 5-4
 - cooling
 - control period..... 5-19, 6-48
 - output manipulated variable (MV) 5-7
 - output manipulated variable lower limit 6-48
 - output manipulated variable upper limit..... 6-48
 - output ON/OFF hysteresis..... 6-42
 - proportional band 5-19
- D**
- decimal point 5-5, 5-6
 - derivative time..... 5-5, 5-18, 6-39
 - difference input control..... 4-14, 4-18, 6-23, 6-24
 - direct control action 6-37
- E**
- expansion modules configuration dialog box..... 6-1
 - external SP 5-11, 5-20, 6-12, 6-24, 6-32, 9-2
 - enable/disable LED..... 2-2
 - input bias..... 5-21, 6-33
 - linear conversion maximum value 5-21, 6-33
 - linear conversion minimum value 5-21, 6-33
- F**
- factory default settings 9-9
 - fixed value control 4-3, 6-36, 7-1
 - full scale 5-19
- H**
- heating/cooling control 4-14, 5-20, 6-38, 7-15
 - cooling method 6-41
 - cooling proportional band 6-42
 - dead band 9-8
 - output action 9-6
 - overlap 9-7
 - hunting phenomenon 8-3
- I**
- I/O function
 - combination 6-25
 - input function 6-23
 - output function..... 6-25
 - initial setting parameters..... 5-3, 5-20, 9-10
 - input
 - operation..... 8-4
 - range 5-22, 6-10
 - status checking..... 8-5
 - input parameters 6-8
 - details..... 6-26
 - input range..... 6-10, 6-26
 - installation and wiring 3-1
 - integral time..... 5-5, 5-18, 6-38
- L**
- linear conversion 6-27
 - linear conversion span 5-19
 - loop break alarm..... 5-9, 8-6, 9-2
 - span..... 5-18, 6-41
 - time 5-18, 6-41

M	
manual mode	9-2
LED.....	2-2
output manipulated variable.....	5-10, 6-40
mounting hole layout for direct mounting	3-1
O	
operating status	5-9
over range	8-5
under range	8-5
operation parameters	5-11
monitor.....	5-8
output	
action.....	9-5
lower limit	6-48
manipulated variable (MV).....	5-7
ON/OFF hysteresis.....	6-40
operation.....	8-2
rate-of-change	6-40
type	5-21, 6-47
upper limit.....	6-48
output parameters	6-19
details.....	6-47
over range	9-4
overlap/dead band.....	5-19, 6-42
P	
parameter range error	5-8
PID module.....	1-1
applicable CPU and WindLDR version	1-2, 1-3
control output	5-9
device allocation.....	5-1
dimensions	2-6
enable control	5-11
monitoring.....	6-54
parameters	6-3
parts description	2-1
power LED (PWR)	8-1
power supply.....	3-6
quantity	6-6
specifications.....	2-3
standby.....	9-4
status	5-4, 5-7
temperature control	4-1
type numbers	1-1
PID module configuration dialog box.....	6-1
process variable (PV).....	5-7
program control	4-9, 6-36, 7-8
advance next	4-10, 5-11
advance previous.....	4-10, 5-11
auto-tuning (AT)	7-13
examples	5-12
hold	4-10, 5-11, 5-15
number of repeats.....	5-21
parameters	5-23, 5-24, 9-11
power failure	4-12
program end action	4-11, 4-12, 5-21, 6-45
program end output.....	4-10, 5-9
program pattern example.....	4-13, 7-8
remaining time.....	5-7
repeat number	5-7, 6-45
run.....	5-11
set point (SP).....	6-49
standby.....	4-12
start	4-10
start type.....	5-21, 6-43
step number	5-7
step time	5-24, 6-49, 7-9, 8-6
step time unit.....	5-21, 6-45
stop	4-10
terminate	5-12
wait	4-10, 5-9, 5-24, 6-50, 7-8, 7-12
program control mode	
LED	2-2
program end action	
continue (repeat)	5-13, 5-14
hold	5-17
terminate	5-12
program parameters	5-3, 5-25, 9-11
details.....	6-49
list.....	6-21
program size	5-2
proportional band.....	6-38
proportional term	5-18, 6-38
PV correction	5-20, 6-26
PV filter time constant.....	5-6, 5-20, 6-27
R	
read only parameters.....	5-7
reset setting	6-39
reverse control action.....	6-37
S	
set point (SP).....	5-5, 5-7, 5-10, 6-38
fall rate	5-18, 6-40
lower limit	6-27
ramp function.....	9-2
rise rate	5-18, 6-40
upper limit.....	6-8, 6-9, 6-27
when program control starts.....	6-45
specifications	
input.....	2-4
output	2-4
T	
terminal	
arrangement	3-4
connection	3-3
type of protection	3-5
U	
user program download and upload	6-3
V	
valid devices.....	5-2
W	
wiring	3-6
write only parameters	5-10, 9-9

Specifications and other descriptions in this brochure are subject to change without notice.

IDEC CORPORATION

6-64, Nishi-Miyahara 2-Chome, Yodogawa-ku, Osaka 532-0004, Japan
Tel: +81-6-6398-2527, Fax: +81-6-6398-2547
E-mail: marketing@idec.co.jp

IDEC CORPORATION (USA)

1175 Elko Drive, Sunnyvale, CA 94089-2209, USA
Tel: +1-408-747-0550 / (800) 262-IDEC (4332)
Fax: +1-408-744-9055 / (800) 635-6246
E-mail: opencontact@idec.com

IDEC CANADA LIMITED

3155 Pepper Mill Court, Unit 4
Mississauga, Ontario, L5L 4X7, Canada
Tel: +1-905-890-8561, Toll Free: (800) 262-IDEC (4332)
Fax: +1-905-890-8562
E-mail: sales@ca.idec.com

IDEC AUSTRALIA PTY. LTD.

Unit 17, 104 Ferntree Gully Road,
Oakleigh, Victoria 3166, Australia
Tel: +61-3-8523-5900, Toll Free: 1800-68-4332
Fax: +61-3-8523-5999
E-mail: sales@au.idec.com

IDEC ELECTRONICS LIMITED

Unit 2, Beechwood, Chineham Business Park,
Basingstoke, Hampshire RG24 8WA, UK
Tel: +44-1256-321000, Fax: +44-1256-327755
E-mail: sales@uk.idec.com

IDEC ELEKTROTECHNIK GmbH

Wendenstrasse 331, 20537 Hamburg, Germany
Tel: +49-40-25 30 54 - 0, Fax: +49-40-25 30 54 - 24
E-mail: service@idec.de

IDEC (SHANGHAI) CORPORATION

Room 701-702 Chong Hing Finance Center,
No. 288 Nanjing Road West, Shanghai 200003, PRC
Tel: +86-21-6135-1515
Fax: +86-21-6135-6225 / +86-21-6135-6226
E-mail: idec@cn.idec.com

IDEC (BEIJING) CORPORATION

Room 211B, Tower B, The Grand Pacific Building,
8A Guanghua Road, Chaoyang District,
Beijing 100026, PRC
Tel: +86-10-6581-6131, Fax: +86-10-6581-5119

IDEC (SHENZHEN) CORPORATION

Unit AB-3B2, Tian Xiang Building, Tian'an Cyber Park,
Fu Tian District, Shenzhen, Guang Dong 518040, PRC
Tel: +86-755-8356-2977, Fax: +86-755-8356-2944

IDEC IZUMI (H.K.) CO., LTD.

Unit G & H, 26/F., MG Tower,
No. 133 Hoi Bun Road, Kwun Tong, Kowloon,
Hong Kong
Tel: +852-2803-8989, Fax: +852-2565-0171
E-mail: info@hk.idec.com

IDEC TAIWAN CORPORATION

8F-1, No. 79, Hsin Tai Wu Road, Sec. 1,
Hsi-Chih District, 22101 New Taipei City, Taiwan
Tel: +886-2-2698-3929, Fax: +886-2-2698-3931
E-mail: service@tw.idec.com

IDEC IZUMI ASIA PTE. LTD.

No. 31, Tannery Lane #05-01,
HB Centre 2, Singapore 347788
Tel: +65-6746-1155, Fax: +65-6844-5995
E-mail: info@sg.idec.com

IDEC ASIA (THAILAND) CO.,LTD.

20th Fl., Sorachai Bldg., No.23/78,
Soi Sukhumvit 63, Sukhumvit Rd.,
Klongton-nua, Wattana, Bangkok 10110
Tel: +662-392-9765, Fax: +662-392-9768
E-mail: sales@th.idec.com

www.idec.com