

FT9Y-B1386(4)

FT1A SERIES
Smart **AXIS**

FBD Programming Manual

IDEC CORPORATION

SAFETY PRECAUTIONS

- Read the SmartAXIS Pro/Lite User's Manual and SmartAXIS Touch User's Manual to make sure of correct operation before starting installation, wiring, operation, maintenance, and inspection of the SmartAXIS.
- All SmartAXIS modules are manufactured under IDEC's rigorous quality control system, but users must add a backup or failsafe provision to the control system when using the SmartAXIS in applications where heavy damage or personal injury may be caused in case the SmartAXIS should fail.
- In this user's manual, safety precautions are categorized in order of importance to Warning and Caution:



Warning Warning notices are used to emphasize that improper operation may cause severe personal injury or death.

- The SmartAXIS is not designed for use in medical equipment, nuclear power, railways, aviation, passenger vehicle equipment, or similar applications requiring a high degree of reliability and safety. The SmartAXIS cannot be used for such applications.
- When using the SmartAXIS in applications not described above that require a high degree of reliability in terms of functionality and precision, appropriate measures such as failsafe mechanisms and redundant mechanisms must be taken for a system containing the SmartAXIS.
- Emergency stop and interlocking circuits must be configured outside the SmartAXIS.
- If relays or transistors in the SmartAXIS output circuits should fail, outputs may remain in the on or off state. For output signals which may cause serious accidents, configure monitor circuits outside the SmartAXIS.
- The SmartAXIS self-diagnostic function may detect internal circuit or program errors, stop programs, and turn outputs off. Configure circuits so that the system containing the SmartAXIS is not jeopardized when outputs turn off.
- Turn off power to the SmartAXIS before installation, removal, wiring, maintenance, and inspection of the SmartAXIS. Failure to turn power off may cause electrical shocks or fire hazard.
- Special expertise is required to install, wire, program, and operate the SmartAXIS. People without such expertise must not use the SmartAXIS.
- Install the SmartAXIS according to the instructions described in SmartAXIS Pro/Lite User's Manual and SmartAXIS Touch User's Manual. Improper installation will result in falling, failure, or malfunction of the SmartAXIS.



Caution Caution notices are used where inattention might cause personal injury or damage to equipment.

- The SmartAXIS is designed for installation in a cabinet. Do not install the SmartAXIS outside a cabinet.
- Install the SmartAXIS in environments described in SmartAXIS Pro/Lite User's Manual and SmartAXIS Touch User's Manual. If the SmartAXIS is used in places where the SmartAXIS is subjected to high-temperature, high-humidity, condensation, corrosive gases, excessive vibrations, and excessive shocks, then electrical shocks, fire hazard, or malfunction will result.
- The environment for using the SmartAXIS is "Pollution degree 2." Use the SmartAXIS in environments of pollution degree 2 (according to IEC 60664-1).
- While moving or transporting prevent the SmartAXIS from falling, otherwise damage or malfunction of the SmartAXIS will result.
- Wiring must use lead sizes that are appropriate for the applied voltage and current. Terminal screws must be tightened with the prescribed tightening torque.
- Prevent metal fragments and pieces of wire from dropping inside the SmartAXIS housing. Put a cover on the SmartAXIS modules during installation and wiring. Ingress of such fragments and chips may cause fire hazard, damage, or malfunction.
- Use a power supply of the rated value. Use of the wrong power supply may cause fire hazard.
- Use an IEC 60127-approved fuse on the power line outside the SmartAXIS. This is required when equipment containing the SmartAXIS is designed for use in Europe.
- Use an IEC 60127-approved fuse on the output circuit. This is required when equipment containing the SmartAXIS is designed for use in Europe.
- Use an EU-approved circuit breaker. This is required when equipment containing the SmartAXIS is destined for Europe.
- Make sure of safety before starting and stopping the SmartAXIS or when operating the SmartAXIS to force outputs on or off. Incorrect operation of the SmartAXIS may cause machine damage or accidents.
- Do not connect the ground wire directly to the SmartAXIS. Connect a protective ground to the cabinet containing the SmartAXIS using an M4 or larger screw. This is required when equipment containing the SmartAXIS is designed for use in Europe.
- Do not disassemble, repair, or modify the SmartAXIS modules.
- The SmartAXIS contains electronic parts and batteries. When disposing of the SmartAXIS, do so in accordance with national and local regulations.

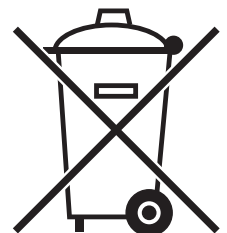

ABOUT THIS MANUAL

This user's manual describes functions, specifications, installation, and operation basics of the SmartAXIS. Also included is information on the powerful communications tools of the SmartAXIS, as well as troubleshooting procedures.

Publication history

August 2013	First Edition
October 2013	Second Edition
August 2014	Third Edition
January 2015	Fourth Edition
December 2019	Fifth Edition

Caution

- The contents of this manual and the SmartAXIS and WindLDR applications are copyright, and all rights are reserved by IDEC Corporation. Unauthorized duplication, reproduction, sales, transfers, or leasing is prohibited.
- The contents of this manual and the SmartAXIS and WindLDR applications are subject to change without notice.
- Please contact your vendor or IDEC Corporation with any problems regarding the operation of this product.

Trademarks

SmartAXIS is a trademark of IDEC Corporation.

IMPORTANT INFORMATION

Under no circumstances shall IDEC Corporation be held liable or responsible for indirect or consequential damages resulting from the use of or the application of IDEC PLC components, individually or in combination with other equipment.

All persons using these components must be willing to accept responsibility for choosing the correct component to suit their application and for choosing an application appropriate for the component, individually or in combination with other equipment.

All diagrams and examples in this manual are for illustrative purposes only. In no way does including these diagrams and examples in this manual constitute a guarantee as to their suitability for any specific application. To test and approve all programs, prior to installation, is the responsibility of the end user.

RELATED MANUALS

The following manuals related to the SmartAXIS are available. Refer to them in conjunction with this manual.

Type No.	Manual Name	Description
FT9Y-B1378	SmartAXIS Pro/Lite User's Manual	Describes product specifications, installation and wiring instructions, instructions for basic programming operations and special functions, device and instruction lists, communication functions, and troubleshooting procedures for the SmartAXIS Pro/Lite series.
FT9Y-B1382	SmartAXIS Ladder Programming Manual	Describes basic operations for ladder programming, instructions for editing and monitoring ladders on the SmartAXIS, available devices and instruction lists, and details of each instruction.
FT9Y-B1386	SmartAXIS FBD Programming Manual (this manual)	Describes basic operations for function block programming, available devices and function block lists, and details of each function block.
FT9Y-B1390	SmartAXIS Touch User's Manual	Describes product specifications, installation and wiring instructions, instructions for setting basic programming actions and special functions, device and instruction lists, communication functions, and troubleshooting procedures for the Touch series.
WindLDR Help		Describes usage instructions for WindLDR, programming software for the SmartAXIS Pro/Lite series.
WindO/I-NV3 Help		Describes programming for the SmartAXIS Touch series, and usage instructions for the WindO/I-NV3 configuration software.

NAMES AND ABBREVIATIONS USED IN THIS MANUAL

Model Names

Name Used in this Manual	Description (Detailed Type No.)
SmartAXIS	FT1A programmable logic controllers.
SmartAXIS Lite	Modules without LCD. (FT1A-B12RA, FT1A-B12RC, FT1A-B24RA, FT1A-B24RC, FT1A-B40RKA, FT1A-B40RSA, FT1A-B40RC, FT1A-B48KA, FT1A-B48SA, FT1A-B48KC, FT1A-B48SC)
SmartAXIS Pro	Modules with LCD. (FT1A-H12RA, FT1A-H12RC, FT1A-H24RA, FT1A-H24RC, FT1A-H40RKA, FT1A-H40RSA, FT1A-H40RC, FT1A-H48KA, FT1A-H48SA, FT1A-H48KC, FT1A-H48SC)
SmartAXIS Touch	Modules that extend the functionality of display. (FT1A-M12RA-W, FT1A-M12RA-B, FT1A-M12RA-S, FT1A-C12RA-W, FT1A-C12RA-B, FT1A-C12RA-S, FT1A-M14KA-W, FT1A-M14KA-B, FT1A-M14KA-S, FT1A-C14KA-W, FT1A-C14KA-B, FT1A-C14KA-S, FT1A-M14SA-W, FT1A-M14SA-B, FT1A-M14SA-S, FT1A-C14SA-W, FT1A-C14SA-B, FT1A-C14SA-S)
12-I/O type	SmartAXIS Pro and Lite models with 12 I/O points. (FT1A-B12RA, FT1A-B12RC, FT1A-H12RA, FT1A-H12RC)
24-I/O type	SmartAXIS Pro and Lite models with 24 I/O points. (FT1A-B24RA, FT1A-B24RC, FT1A-H24RA, FT1A-H24RC)
40-I/O type	SmartAXIS Pro and Lite models with 40 I/O points. (FT1A-B40RKA, FT1A-B40RSA, FT1A-B40RC, FT1A-H40RKA, FT1A-H40RSA, FT1A-H40RC)
48-I/O type	SmartAXIS Pro and Lite models with 48 I/O points. (FT1A-B48KA, FT1A-B48SA, FT1A-B48KC, FT1A-B48SC, FT1A-H48KA, FT1A-H48SA, FT1A-H48KC, FT1A-H48SC)
AC power type	SmartAXIS Pro and Lite models with an AC power supply. (FT1A-B12RC, FT1A-H12RC, FT1A-B24RC, FT1A-H24RC, FT1A-B40RC, FT1A-H40RC, FT1A-B48KC, FT1A-B48SC, FT1A-H48KC, FT1A-H48SC)
DC power type	SmartAXIS Pro and Lite models with a DC power supply. (FT1A-B12RA, FT1A-H12RA, FT1A-B24RA, FT1A-H24RA, FT1A-B40RKA, FT1A-H40RKA, FT1A-B40RSA, FT1A-H40RSA, FT1A-B48KA, FT1A-B48SA, FT1A-H48KA, FT1A-H48SA)
Touch (Relay output type)	SmartAXIS Touch with relay output. (FT1A-M12RA-W, FT1A-M12RA-B, FT1A-M12RA-S, FT1A-C12RA-W, FT1A-C12RA-B, FT1A-C12RA-S)
Touch (Transistor output type)	SmartAXIS Touch with transistor output. (FT1A-M14KA-W, FT1A-M14KA-B, FT1A-M14KA-S, FT1A-C14KA-W, FT1A-C14KA-B, FT1A-C14KA-S, FT1A-M14SA-W, FT1A-M14SA-B, FT1A-M14SA-S, FT1A-C14SA-W, FT1A-C14SA-B, FT1A-C14SA-S)

Abbreviations

Abbreviation	Meaning
FB	Function block For example, the AND (logical AND) function block is described as AND FB.
FBD	Function block diagram

TABLE OF CONTENTS

	Safety Precautions.....	Preface-1
	About This Manual.....	Preface-2
	Related Manuals.....	Preface-3
	Names and Abbreviations Used in this Manual	Preface-4
CHAPTER 1:	Operation Basics	
	Starting WindLDR and PLC Selection	1-1
	Creating FBD Program	1-3
	Convert Program	1-9
	Saving a Project	1-10
	Simulation	1-11
	Download Program.....	1-12
	Monitor Operation	1-14
	Quit WindLDR	1-15
CHAPTER 2:	Basic Operations on the Module	
	Basic Operations	2-1
CHAPTER 3:	Device Addresses	
	Device Addresses	3-1
	Special Internal Relays.....	3-2
	Special Data Registers	3-7
CHAPTER 4:	FB Reference	
	FB List	4-1
	Advanced Instruction Applicable SmartAXIS	4-7
	Applicable Data Types	4-8
CHAPTER 5:	The input FB	
	I (Digital Input).....	5-1
	SM (Special Internal Relay)	5-2
	R (Shift Register).....	5-3
	AI (Analog Input)	5-4
CHAPTER 6:	The output FB	
	Q (Digital Output).....	6-1
	M (Internal Relay)	6-2
CHAPTER 7:	The logical operation FB	
	AND (Logical AND)	7-1
	NAND (Negative Logical AND)	7-2
	OR (Logical OR)	7-3
	NOR (Negative Logical OR)	7-4
	XOR (Exclusive Logical OR)	7-5
	XNOR (Negative Exclusive Logical OR)	7-6
	NOT (Negation).....	7-7
	SOTU (Shot Up)	7-8
	SOTD (Shot Down).....	7-9
	TRUTH (Truth Table).....	7-10
CHAPTER 8:	The timer FB	
	TIMU (On-delay Count Up Timer)	8-1
	TIMD (On-delay Count Down Timer).....	8-5
	TIMOU (Off-delay Count Up Timer).....	8-7
	TIMOD (Off-delay Count Down Timer)	8-9
	TIMCU (On/off-delay Timer).....	8-11
	SPULS (Single Shot Pulse).....	8-14
	DTIM (Dual Timer)	8-16

TABLE OF CONTENTS

	RPULS (Random Pulse Output)	8-19
CHAPTER 9:	The counter FB	
	CNT (Adding Counter)	9-1
	CUD (Up/Down Selection Reversible Counter)	9-3
	HOUR (Hour Meter)	9-7
CHAPTER 10:	The shift register FB	
	SFR (Shift Register).....	10-1
CHAPTER 11:	The comparison FB	
	CMP (Data Comparison)	11-1
	STTG (Schmitt Trigger)	11-3
	RCMP (Range Comparison).....	11-5
CHAPTER 12:	The data conversion FB	
	ALT (Alternate Output).....	12-1
CHAPTER 13:	The week programmer FB	
	WEEK (Weekly Timer)	13-1
	YEAR (Yearly Timer)	13-13
CHAPTER 14:	The interface FB	
	MSG (Message).....	14-1
CHAPTER 15:	The pulse FB	
	PULS (Pulse Output)	15-1
	PWM (Pulse Width Modulation)	15-6
	RAMP (Ramp Pulse Output)	15-11
	ZRN (Zero Return)	15-21
	ARAMP (Advanced Ramp).....	15-26
CHAPTER 16:	The data logging FB	
	DLOG (Data Log)	16-1
	TRACE (Data Trace).....	16-8
CHAPTER 17:	The script FB	
	SCRPT (Script).....	17-1
CHAPTER 18:	The special FB	
	HSC (High-speed Counter).....	18-1
	RSFF (RS Flip-flop).....	18-3
APPENDIX		
	Processing in One Scan	A-1
	FBD Program Processing	A-1
	Scan End Processing Time	A-1
	FB Execution Time	A-2
	FBD Program Size	A-3
INDEX		
	FB Index	1-2

1: OPERATION BASICS

This chapter describes basic instructions for operating WindLDR, software required for programming and maintenance of the SmartAXIS Pro/Lite series.

Note: SmartAXIS Touch series require WindO/I-NV3 for programming. See the SmartAXIS Touch User's Manual for instructions for programming and basic operation of WindO/I-NV3 with the Touch series.

Starting WindLDR and PLC Selection

This section describes PLC selection and configuring the programming method.

1. Launch WindLDR.

■ Windows 10

Click **Start** button and then > **All Apps** > **IEC Automation Organizer** > **WindLDR**.

■ Windows 8

Click **WindLDR** in the tiles on the Start screen.

■ Windows 7

Click **Start** and then **Programs** > **IEC Automation Organizer** > **WindLDR**.

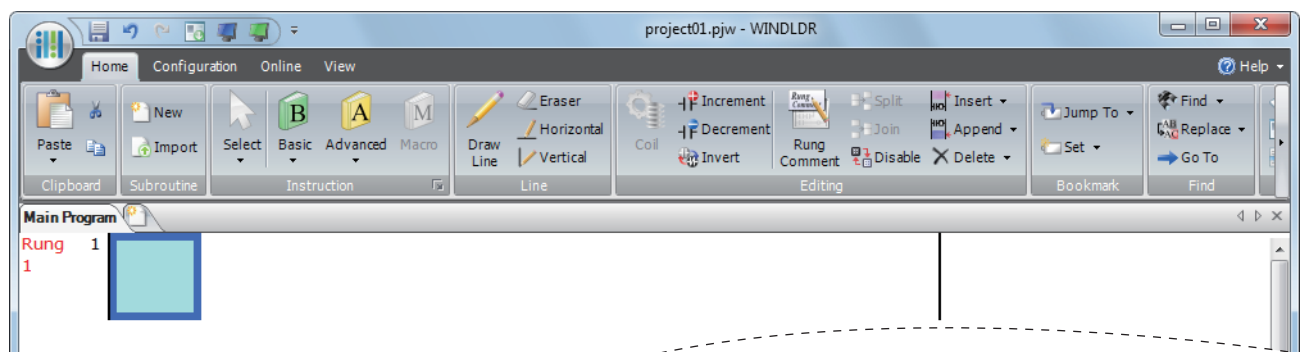

2. From the WindLDR menu bar, select **Configuration** > **PLC** > **PLC Type**.

The PLC Selection dialog box is displayed.

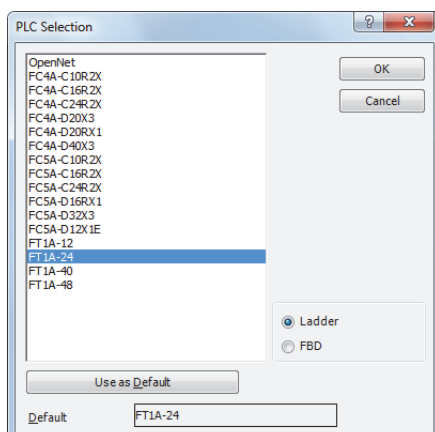

1: OPERATION BASICS

In WindLDR, the SmartAXIS is classified by the number of inputs and outputs, and the names of product series are listed as follows.

PLC Selection Option	SmartAXIS Type No.
FT1A-12	FT1A-H12RA, FT1A-B12RA, FT1A-H12RC, FT1A-B12RC
FT1A-24	FT1A-H24RA, FT1A-B24RA, FT1A-H24RC, FT1A-B24RC
FT1A-40	FT1A-H40RKA, FT1A-H40RSA, FT1A-B40RKA, FT1A-B40RSA, FT1A-H40RC, FT1A-B40RC
FT1A-48	FT1A-H48KA, FT1A-H48SA, FT1A-B48KA, FT1A-B48SA, FT1A-H48KC, FT1A-H48SC, FT1A-B48KC, FT1A-B48SC
FT1A Touch	FT1A-M12RA-W, FT1A-M12RA-B, FT1A-M12RA-S, FT1A-C12RA-W, FT1A-C12RA-B, FT1A-C12RA-S, FT1A-M14KA-W, FT1A-M14KA-B, FT1A-M14KA-S, FT1A-C14KA-W, FT1A-C14KA-B, FT1A-C14KA-S, FT1A-M14SA-W, FT1A-M14SA-B, FT1A-M14SA-S, FT1A-C14SA-W, FT1A-C14SA-B, FT1A-C14SA-S

If the Use as Default button is pressed, then the same PLC and programming language will be selected as default when WindLDR is started next time.

3. Select a PLC type in the selection box, select FBD as the programming language, and click **OK**.

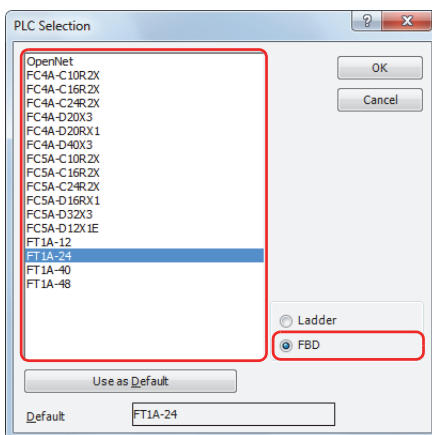

4. The WindLDR menu bar is updated and the FBD editor opens.

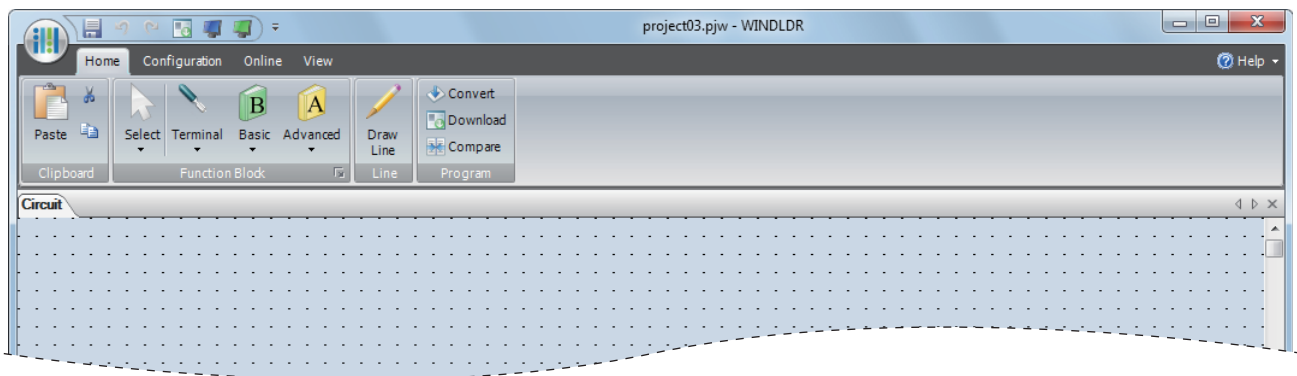

Starting WindLDR and PLC selection are now complete. How to create a FBD program is described in the following pages.

Creating FBD Program

This section describes the procedure for creating a FBD program in WindLDR.

Note: For details about the individual FB, see "FB Reference" on page 4-1.

Create a sample program using WindLDR that performs the following operations:

- When input I0 and input I1 are both on, output Q0 is turned on.
- When either input I1 or input I2 is on, output Q1 turns on and off continuously in one second cycle.

Circuit block	Input I0	Input I1	Input I2	Action
Q0	ON	ON	–	Output Q0 is turned on.
Q1	–	OFF	ON	Output Q1 is turned on and off in one second cycle.
	–	ON	OFF	

Note: A group of FBs containing an output FB and all FBs connected on the left side of the output FB is called a circuit block. The output of the output FB is the execution result of a single circuit block.

Insert input I0

1. From the WindLDR menu bar, click **Home > Function Block > Terminal > I (Digital Input)**.

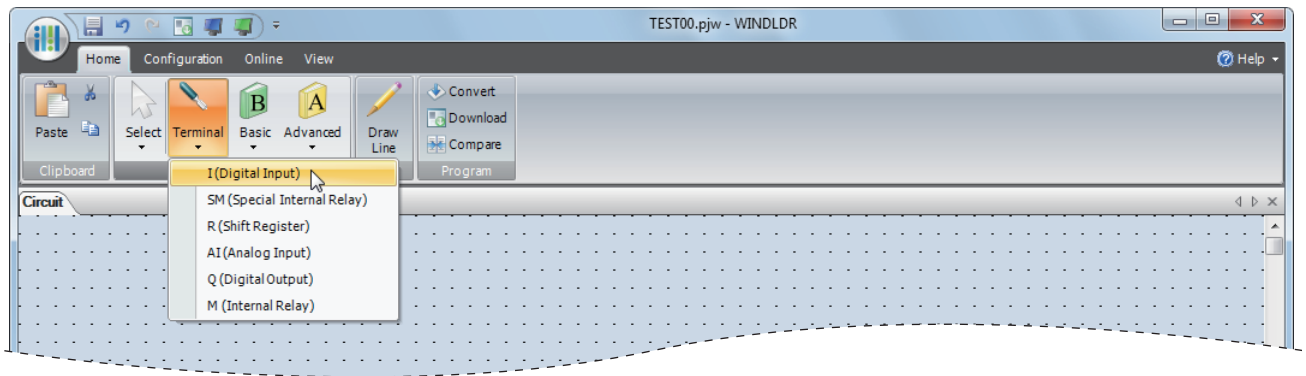

2. Move the mouse pointer to the FBD editor and click the left-mouse button.

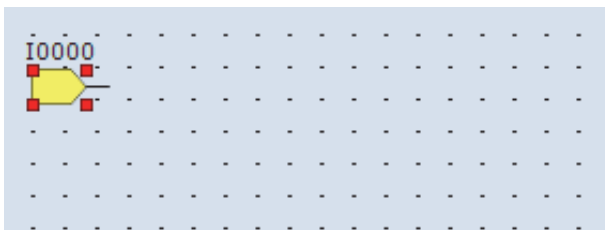

Input I0 is inserted at the position of the mouse pointer.

Insert the AND (logical AND) FB

1. From the WindLDR menu bar, click **Home > Function Block > Basic >AND (Logical AND)**.

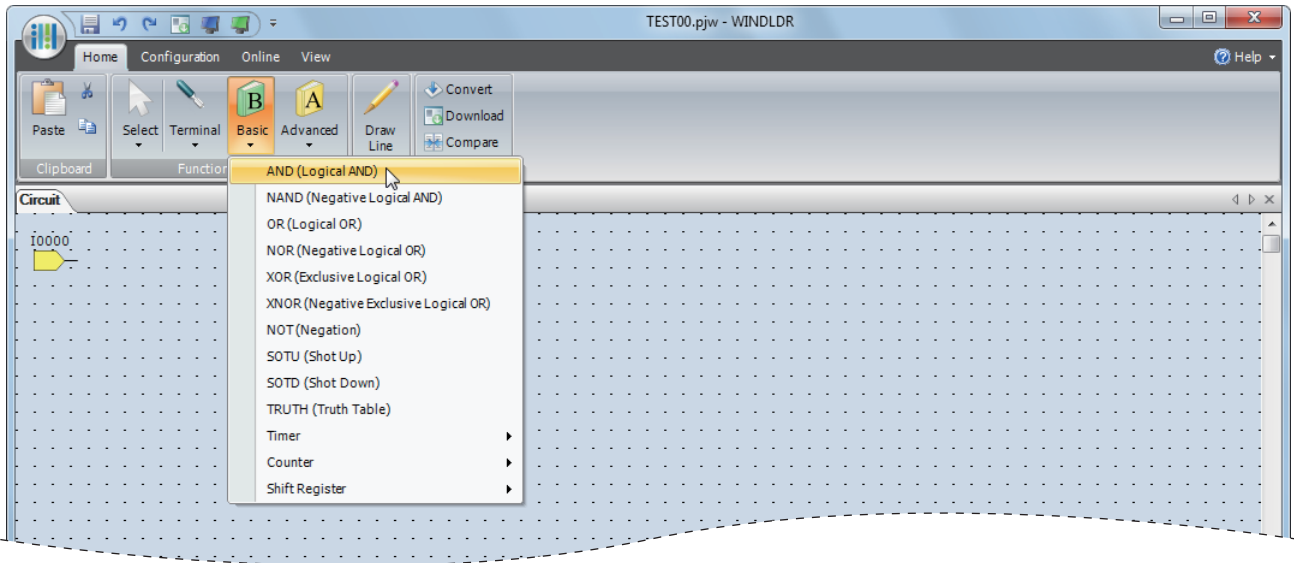

2. Move the mouse pointer to the FBD editor and click the left-mouse button.

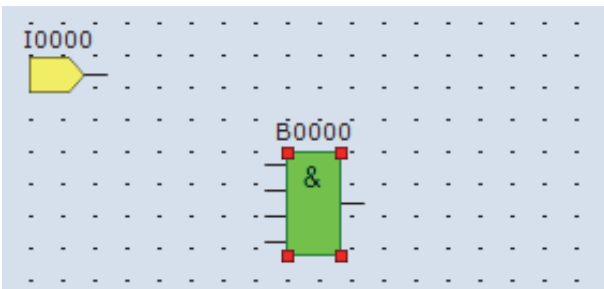

AND B0 is inserted at the position of the mouse pointer.

Connect input I0 and AND B0 with a connection line

1. From the WindLDR menu bar, click **Home > Line > Draw Line**.

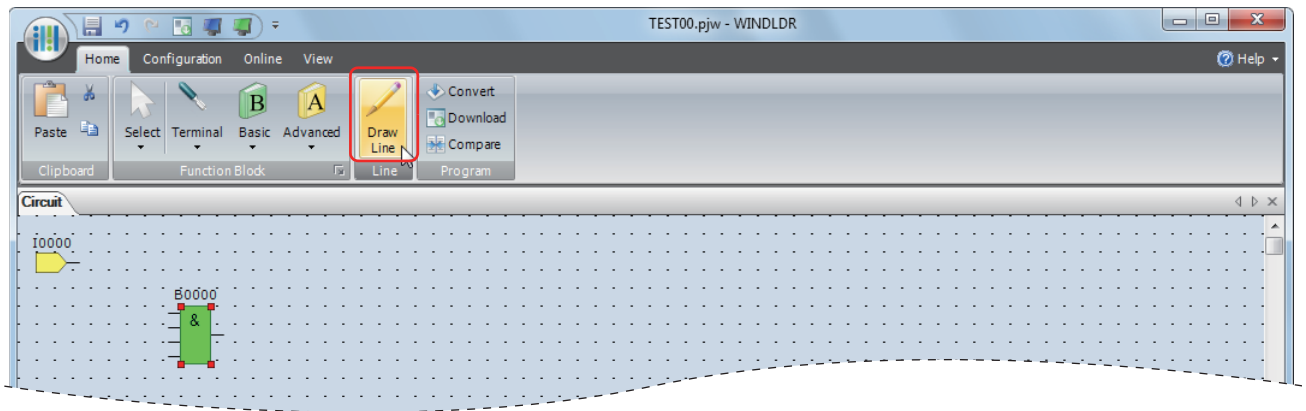

2. Move the mouse pointer to the output connector of the input I0.

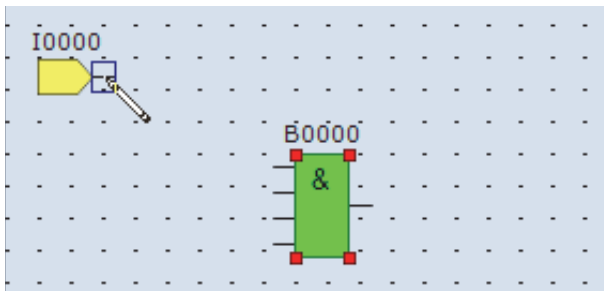

3. Click the left-mouse button and drag the line to the input 1 connector of the AND B0.

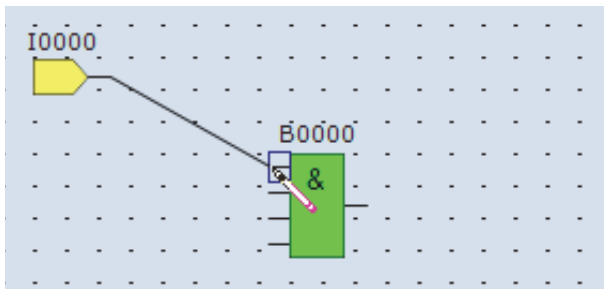

4. Release the left-mouse button.

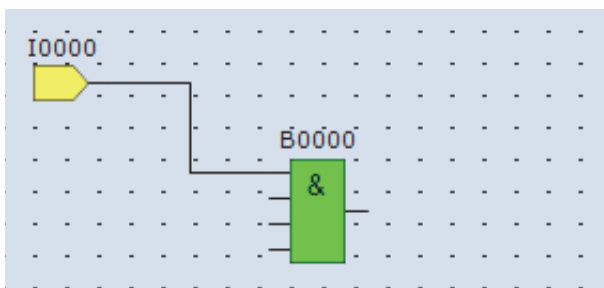

The output connector of the input I0 and the input 1 connector of the AND B0 are connected.

1: OPERATION BASICS

Insert output Q0 and connect it to the output of the AND B0

1. From the WindLDR menu bar, click **Home > Function Block > Terminal > Q (Digital Output)**.

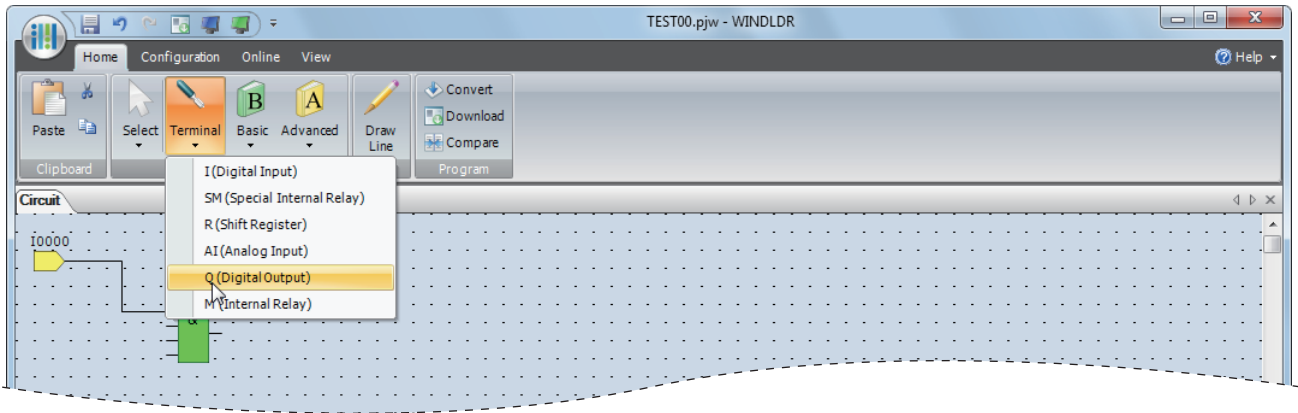

2. Move the mouse pointer to the FBD editor and click the left-mouse button.

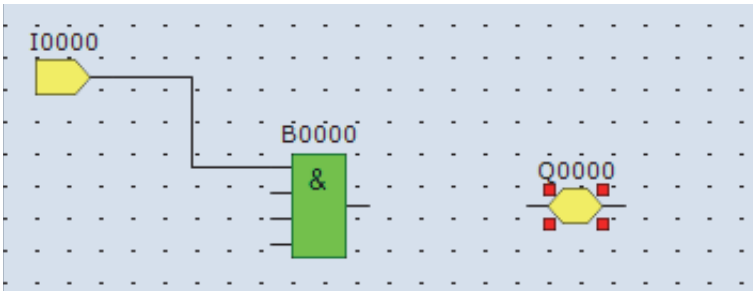

Output Q0 is inserted at the position of the mouse pointer.

3. Connect the output connector of the AND B0 and the input connector of the output Q0 with a connection line. Connect them in the same manner as "Connect input I0 and AND B0 with a connection line" on page 1-5.

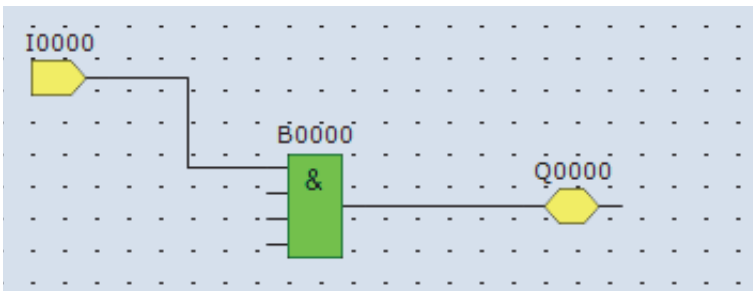

Insert input I1 and connect it to the input 2 of the AND B0

Insert input I1 in the same manner as "Insert input I0" on page 1-3 and connect it to the input 2 of the AND B0 with a connection line in the same manner as "Connect input I0 and AND B0 with a connection line" on page 1-5.

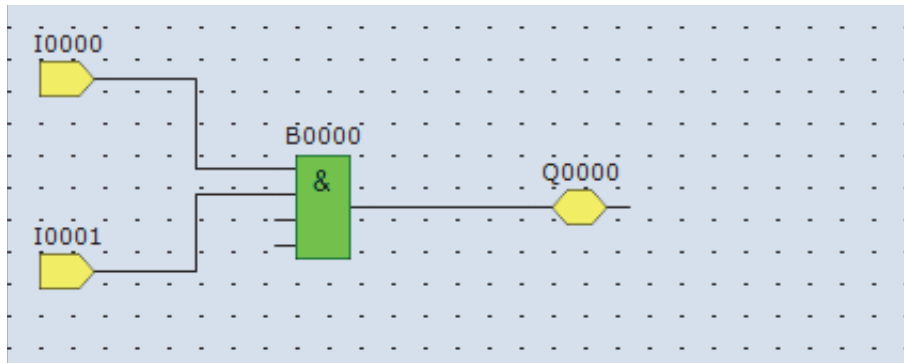
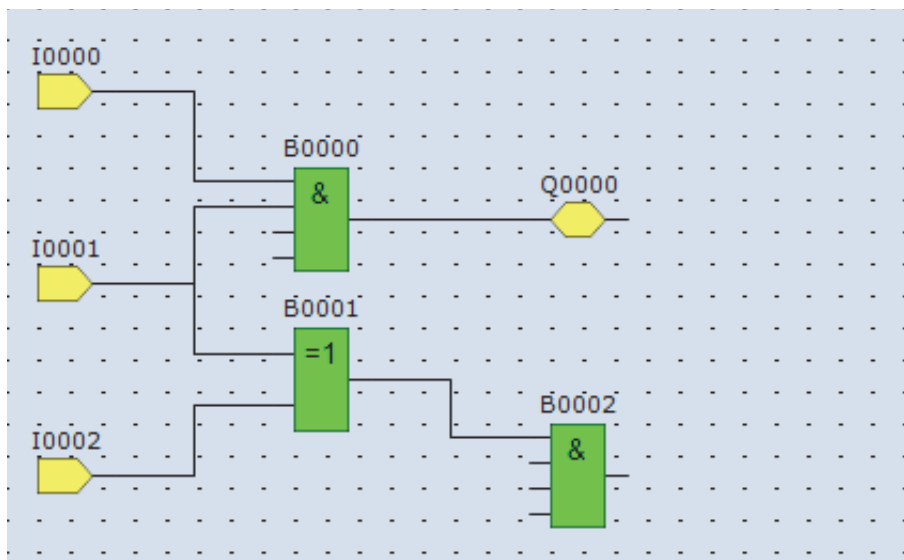
**Insert input I2 and XOR B1 and connect input I1 and input I2 to the inputs 1 and 2 of the XOR FB**

Note: A single FB output connector can be connected to multiple FB input connectors. Multiple FB output connectors cannot be connected to a single FB input connector.

Insert special internal relay M8121, AND B2, and output Q1 and connect them with connection lines

Note: M8121 is a special internal relay turning on and off continuously in one second cycle. For details on the special internal relay, see "Device Addresses" - "Special Internal Relays" - "Special Internal Relay Device Addresses" on page 3-2.

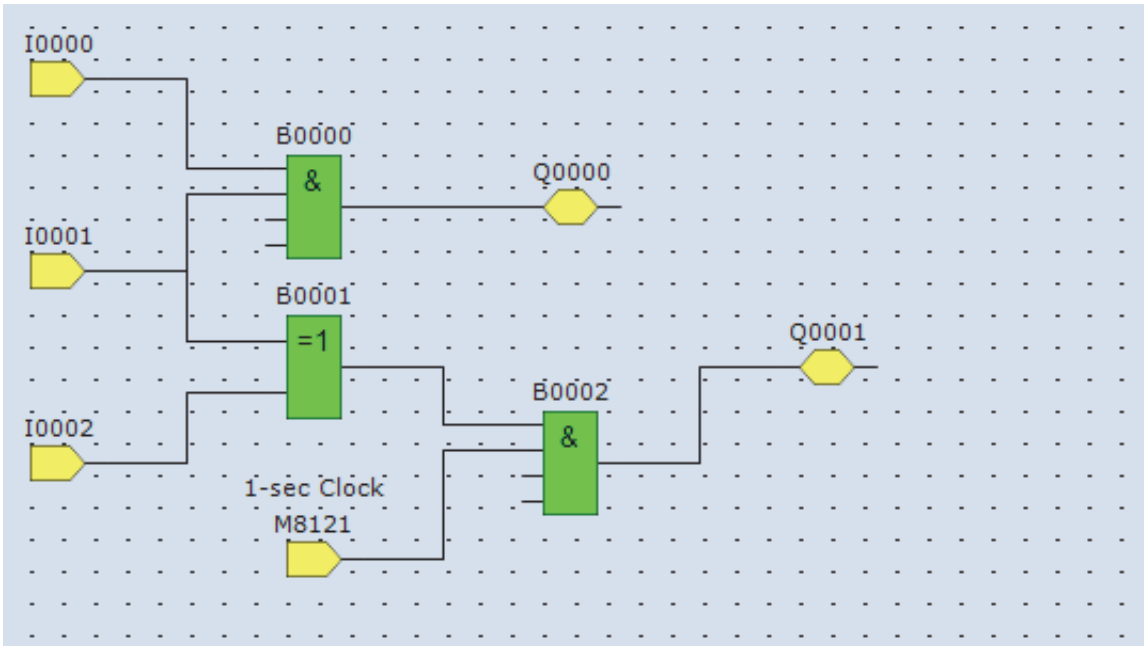

Creating FBD program is completed.

Convert Program

1. Confirm that the program has been correctly created.

From the WindLDR menu bar, click **Home > Program > Convert**.

If the FBs are correctly connected, the conversion will be successful. If any errors are found, those errors are displayed in the Info Window. Correct the program to clear those errors in order.

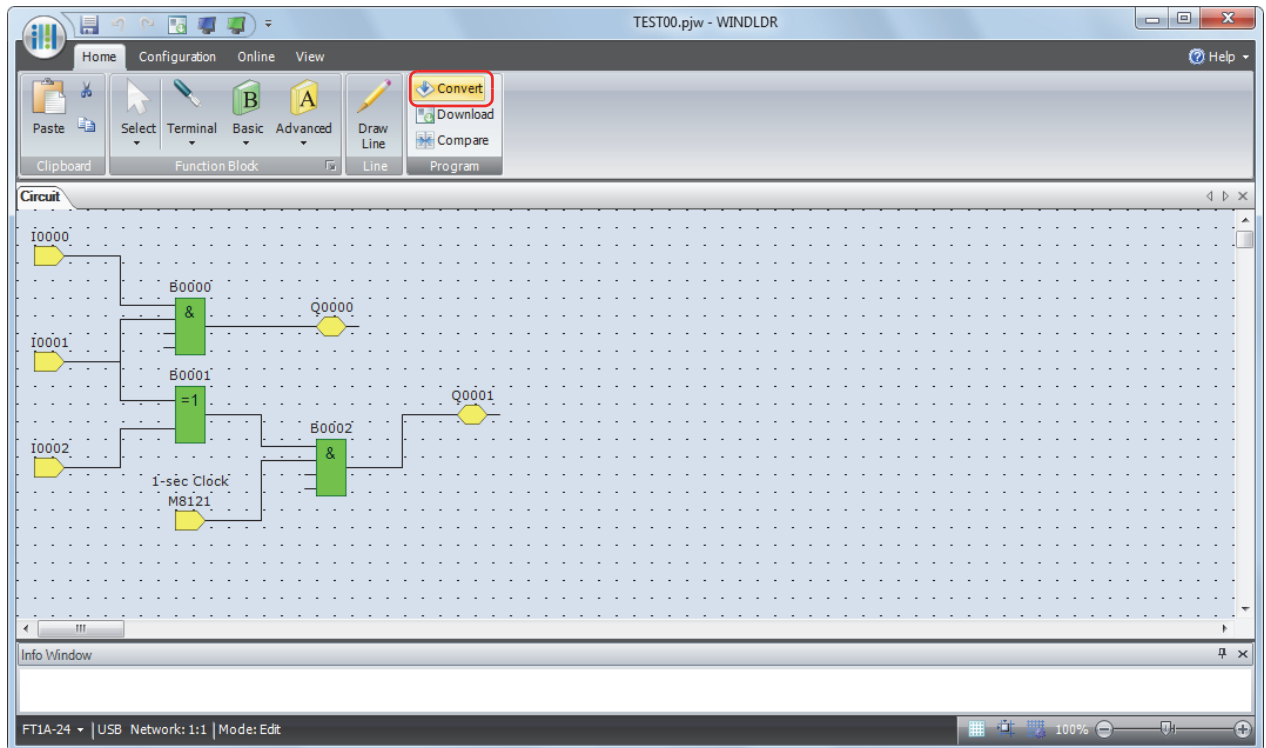

Saving a Project

1. Give the project a name and save it.

From the Application menu , click **Save As > WindLDR Project**.

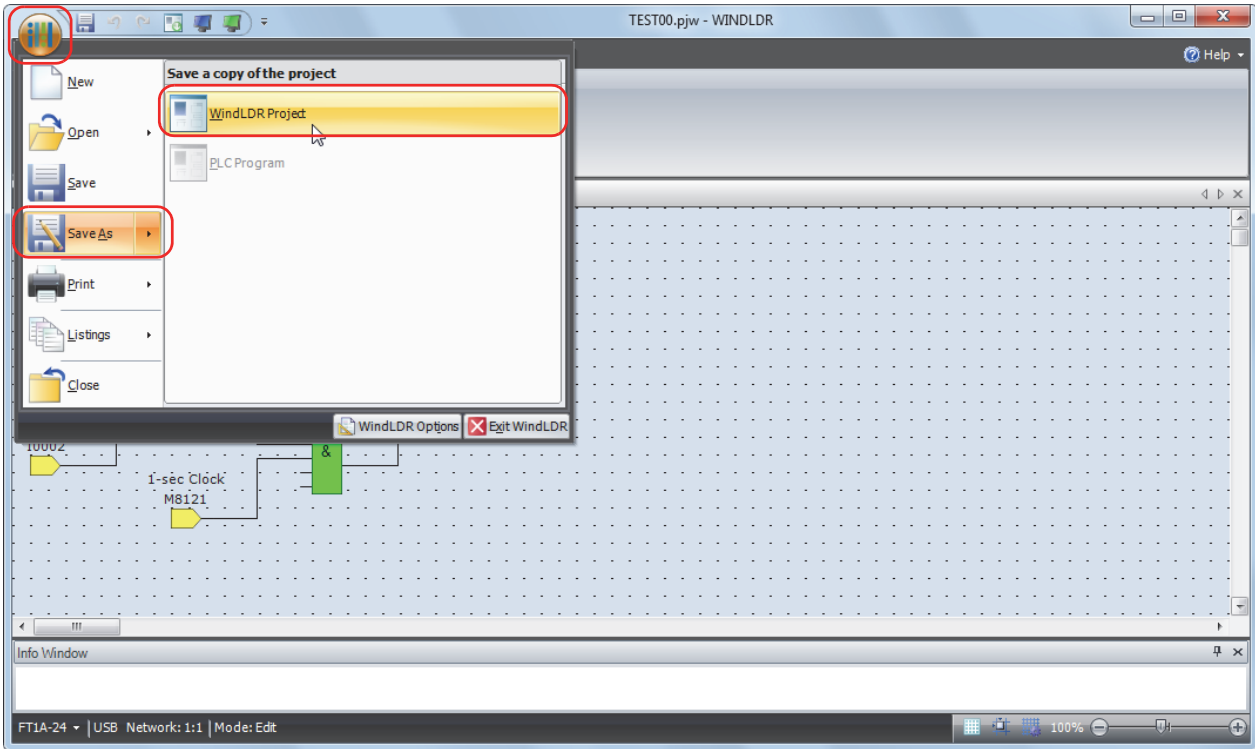

2. Specify the project file name as "TEST01.pjw", specify the folder to save to, and click **Save**.

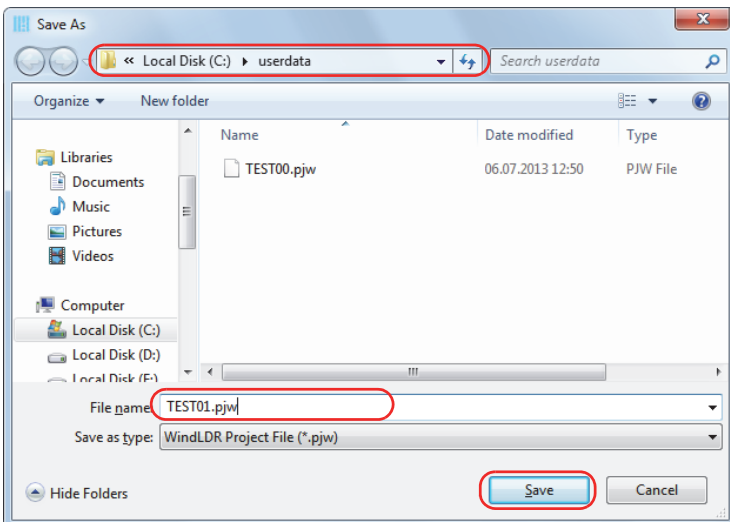

The project is saved to the specified file.

Simulation

Before transferring the user program to the SmartAXIS, you can check the operation of the program in WindLDR. To check program operation on the SmartAXIS, external devices must be connected to the SmartAXIS and inputs must be turned on and off, but with the simulation function, input I states can also be changed in WindLDR, which enables you to check the operation of the program.

1. From the WindLDR menu bar, select **Online > Simulation > Simulation**.
2. Double-click the input FB you wish to change its state.

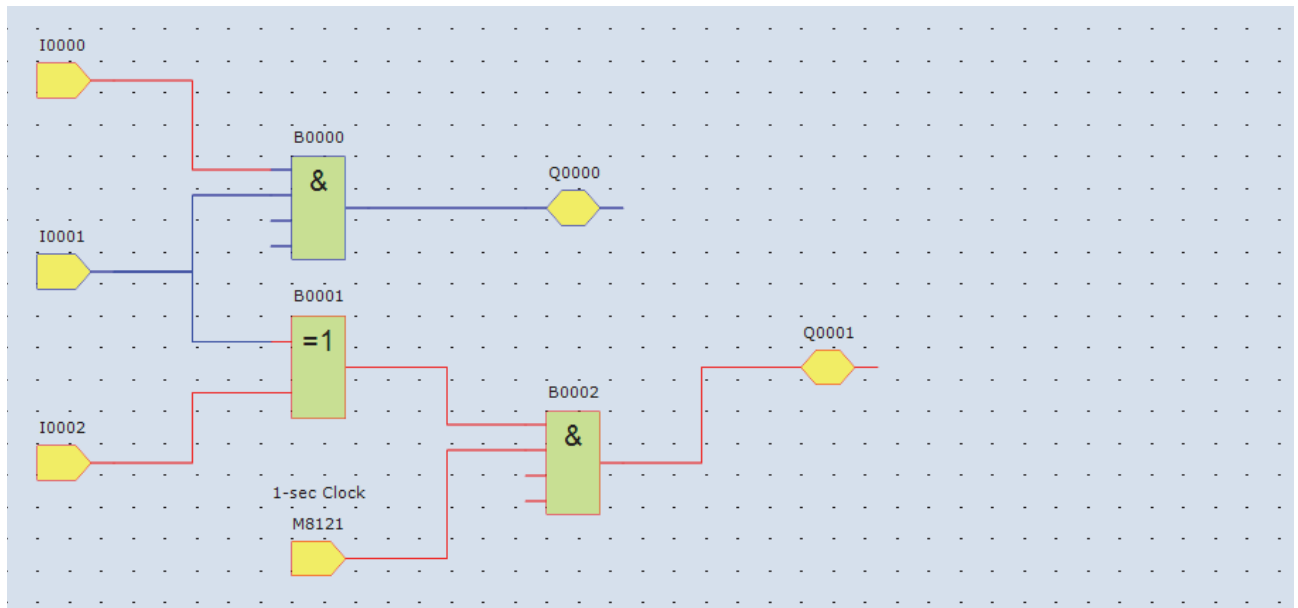

- When you turn on both input I0 and input I1, output Q0 is turned on.
- When you turn on either input I1 or input I2, output Q1 is turned on and off continuously in one second cycle.

Notes:

- To end the simulation function, select **Online > Simulation > Simulation** again.
- You can monitor the state of the input connectors and output connectors of each FB. When input connectors, output connectors, and connection lines are red, they are on. Blue indicates off.
- For details on the state of unconnected input connectors of each FB, see the chapters for the FBs.

Download Program

To download a user program to the SmartAXIS, the communication method must be configured in advance. The user program can be downloaded to the SmartAXIS using WindLDR over a USB connection or an Ethernet connection. This section describes the procedure, from configuring the communication method to downloading the user program, using a USB connection as an example.

To use a USB connection, the SmartAXIS USB port must be connected to a computer using a USB cable.

Windows computer

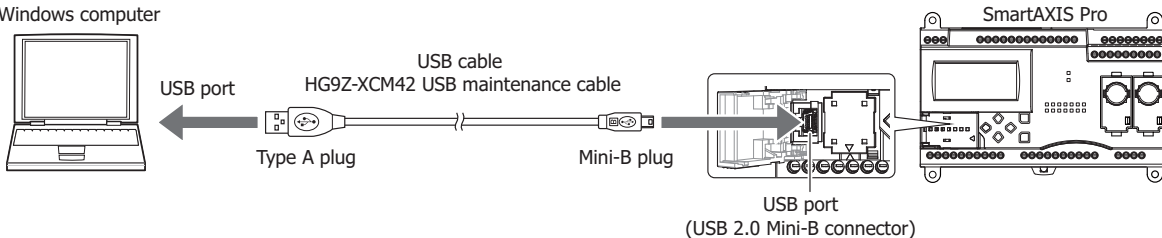

Note: To communicate with the SmartAXIS via a USB connection, the dedicated USB driver must be installed in the computer.

For the driver installation procedure, see "How to install USB driver". Click ▼ to the right of the  icon at the top right corner of the WindLDR window and click **How to install USB driver** to display **How to install USB driver**.

Configuration Procedure

1. From the WindLDR menu bar, select **Online > Communication > Set Up**.
2. The Communication Settings dialog box is displayed. Click the **USB** tab and then click **OK**.

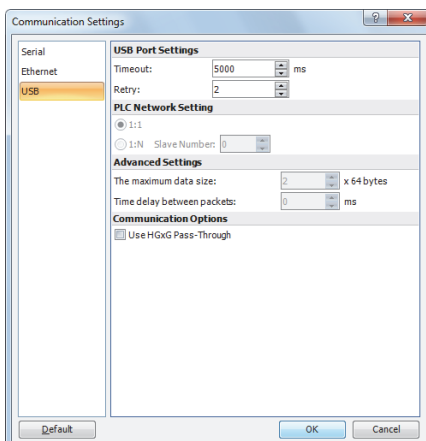

The communication method is now set to the USB connection. Next, download a user program.

3. From the WindLDR menu bar, select **Online > Transfer > Download > Download**. The Download dialog box is displayed.

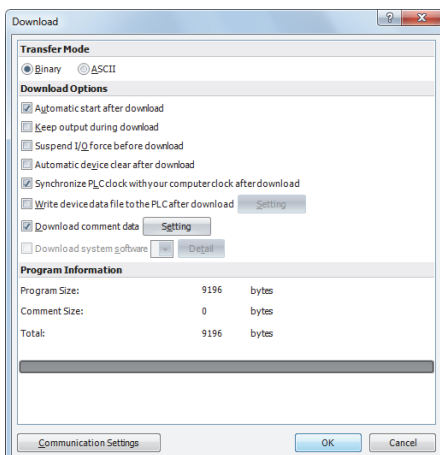

The user program is downloaded to the SmartAXIS when you click **OK**.

Notes:

- The created program is downloaded to the SmartAXIS along with the function area settings.
- For the function area settings, see Chapter 5 "Special Functions" in the "SmartAXIS Pro/Lite User's Manual".

4. When the following message is displayed, the user program download is successful.

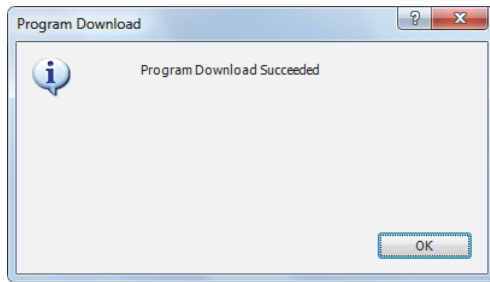

Monitor Operation

You can monitor the operations of the downloaded user program using the monitor function of WindLDR.

1. After the user program is successfully downloaded, from the WindLDR menu bar, select **Online > Monitor > Monitor**. The SmartAXIS state is displayed on the WindLDR screen.

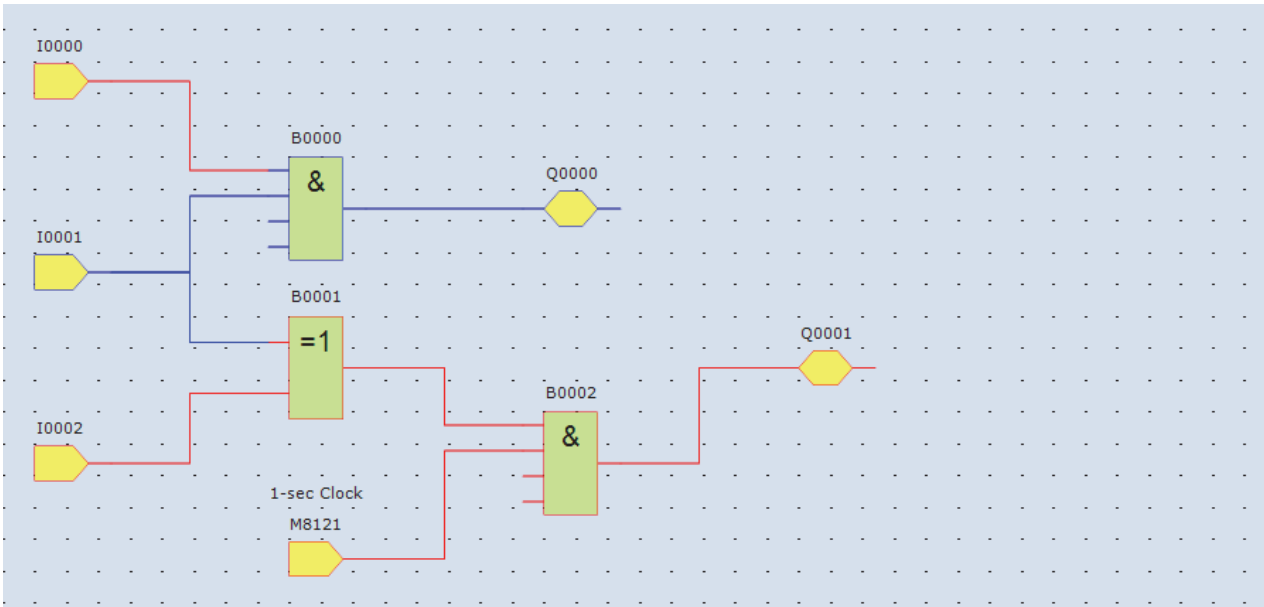

2. Monitor the following operations.

- When you turn on both input I0 and input I1, output Q0 is turned on.
- When you turn on either input I1 or input i2, output Q1 is repeatedly turned on and off in one second cycle.

The monitor operation is complete.

Notes:

- You can monitor the state of the input connectors and output connectors of each FB. When input connectors, output connectors, and connection lines are red, they are on. Blue indicates off.
- For details on the state of unconnected input connectors of each FB, see the chapters for the FBs.

Quit WindLDR

1. From the Application menu , click **Exit WindLDR**.

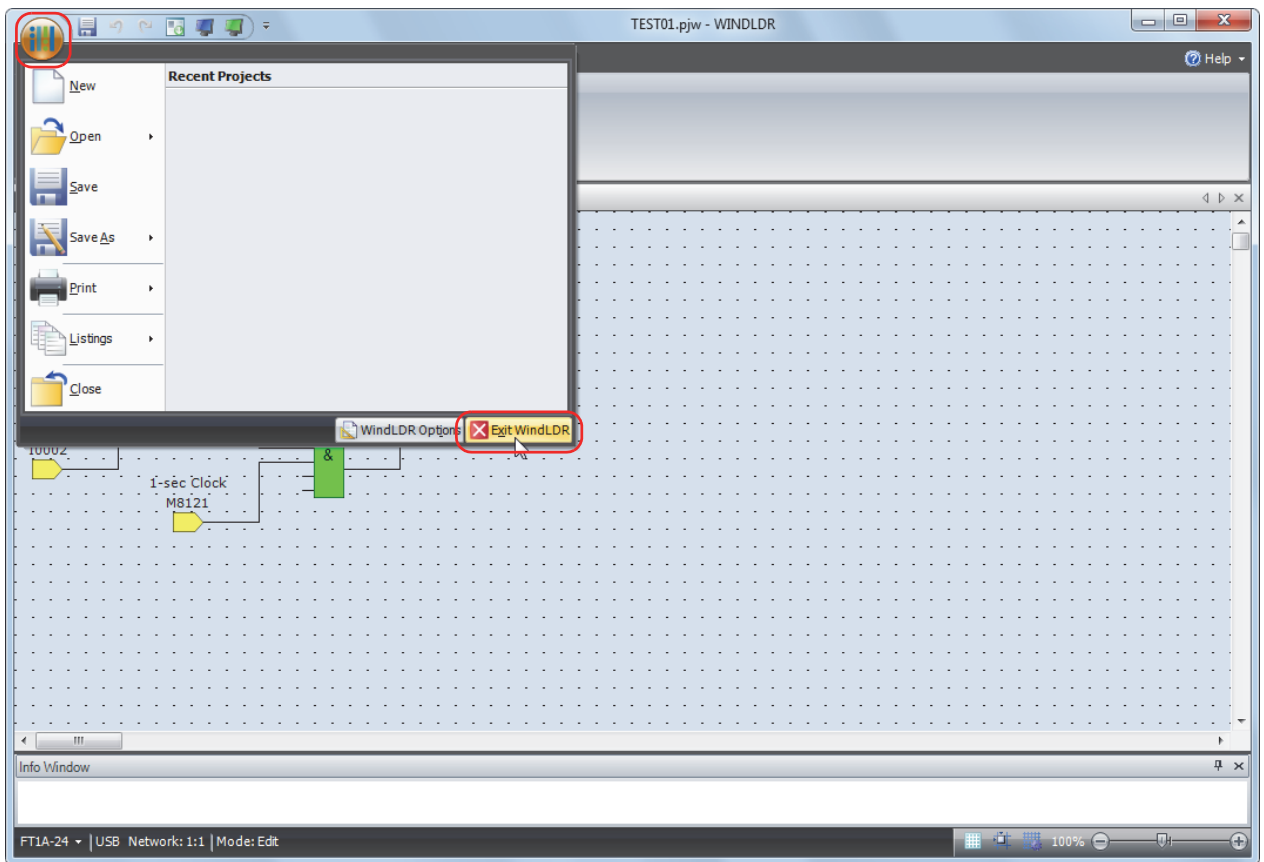

WindLDR exits.

2: BASIC OPERATIONS ON THE MODULE

Introduction

You can run and stop the SmartAXIS, monitor device values, and modify settings of the SmartAXIS Pro and Touch with the LCD and operation buttons on the module without using WindLDR. This chapter describes the basic operations of the operation buttons.

Notes

- For other functions of the SmartAXIS Pro, refer to the "SmartAXIS Pro/Lite User's Manual".
- For other functions of the SmartAXIS Touch, refer to the "SmartAXIS Touch User's Manual".

Applicable SmartAXIS

FT1A-12	FT1A-24	FT1A-40	FT1A-48	FT1A Touch
X	X	X	X	X

Basic Operations

LCD and Operation Buttons

SmartAXIS Pro

The standard screen, the system menu, and custom messages can be displayed on the LCD.

The operation buttons are laid out on SmartAXIS Pro as shown in the diagram on the right.

A total of six buttons, ◀ (left), ▲ (up), ▼ (down), ▶ (right), ESC (ESC), and OK (OK), are available to use.

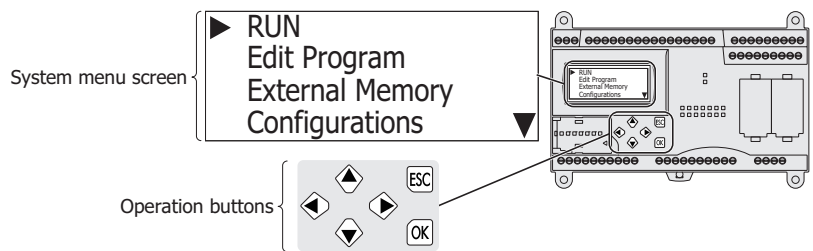

SmartAXIS Touch

The Touch can be operated using the buttons displayed on the LCD.

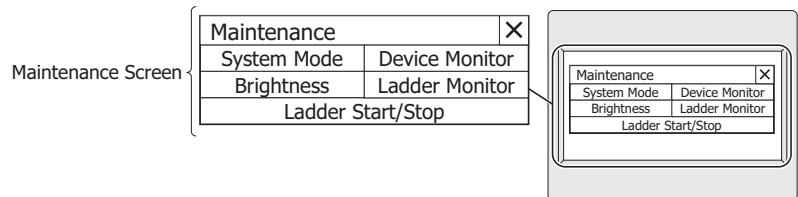

Button Operations

The button operations differ when the button is pressed and released and when the button is pressed and held.

Press/Hold	Operation
Press	The button is pressed for 0.1 seconds or more and less than 2 seconds and then released.
Press and hold	The button is pressed for 2 seconds or more and then released.

3: DEVICE ADDRESSES

Introduction

This chapter describes device addresses available for the SmartAXIS Pro/Lite to program FBD. Special internal relays and special data registers are also described.

The SmartAXIS is programmed using devices such as inputs, outputs, remote inputs, remote outputs, internal relays, timers, counters, shift registers, and data registers.

Inputs (I) are relays to receive input signals through the input terminals.

Remote inputs (I) are relays to receive input signals from external devices connected to the remote I/O slaves.

Outputs (Q) are relays to send the processed results of the user program to the output terminals.

Remote outputs (O) are relays to send output signals to external devices connected to the remote I/O slaves.

Internal relays (M) are relays used in the CPU and cannot be output to the output terminals.

Special internal relays (M) are internal relays dedicated to specific functions.

Timers (T) are relays used in the user program, available as 1-sec, 100-ms, 10-ms, and 1-ms timers.

Counters (C) are relays used in the user program, available as adding counter, reversible counter, and hour meter FBs.

Shift registers (R) are registers to shift the data bits according to pulse inputs.

Data registers (D) are registers used to store numerical data.

Special data registers (D) are dedicated to special functions.

Device Addresses

Available I/O numbers depend on the SmartAXIS type.

Device	FT1A-12		FT1A-24		FT1A-40		FT1A-48		FT1A Touch	
	Device Address	Points	Device Address	Points	Device Address	Points	Device Address	Points	Device Address	Points
Input (I)*1	I0 - I7	8	I0 - I7 I10 - I17	16	I0 - I7 I10 - I17 I20 - I27	24	I0 - I7 I10 - I17 I20 - I27 I30 - I35	30	I0 - I7	8
Remote Input (I)*1	—	—	I40 - I75 I80 - I115 I120 - I155	90	I40 - I75 I80 - I115 I120 - I155	90	I40 - I75 I80 - I115 I120 - I155	90	I40 - I75 I80 - I115 I120 - I155	90
Output (Q)*1	Q0 - Q3	4	Q0 - Q7	8	Q0 - Q7 Q10 - Q17	16	Q0 - Q7 Q10 - Q17 Q20, Q21	18	Q0 - Q3	4
Remote Output (Q)*1	—	—	Q40 - Q61 Q80 - Q101 Q120 - Q141	54	Q40 - Q61 Q80 - Q101 Q120 - Q141	54	Q40 - Q61 Q80 - Q101 Q120 - Q141	54	Q40 - Q61 Q80 - Q101 Q120 - Q141	54
Internal Relay (M)*1	M0 - M317	256	M0 - M1277	1024	M0 - M1277	1024	M0 - M1277	1024	M0 - M1277	1024
Special Internal Relay (M)*1	M8000 - M8177	144	M8000 - M8177	144	M8000 - M8177	144	M8000 - M8177	144	M8000 - M8177	144
Shift Register (R)	R0 - R127	128	R0 - R127	128	R0 - R127	128	R0 - R127	128	R0 - R127	128
Timer (T)	T0 - T99	100	T0 - T199	200	T0 - T199	200	T0 - T199	200	T0 - T199	200
Counter (C)	C0 - C99	100	C0 - C199	200	C0 - C199	200	C0 - C199	200	C0 - C199	200
Data Register (D)*3	D0 - D399	400	D0 - D1999*2	2000	D0 - D1999*2	2000	D0 - D1999*2	2000	D0 - D1999	2000
Special Data Register (D)	D8000 - D8199	200	D8000 - D8199	200	D8000 - D8199	200	D8000 - D8199	200	D8000 - D8199	200

Notes:

*1 The least significant digit of input, output, internal relay, and special internal relay device address is an octal number (0 through 7). Upper digits are decimal numbers.

*2 Out of data registers D0 through D1999, D1000 through D1999 cannot be designated as "keep" types. Retained in STOP→RUN, but cleared when the power is turned on.

*3 For SmartAXIS Pro/Lite, when you use data register ROM backup, you can initialize the data registers with the values backed up in ROM. For details, see Chapter 5 "Special Functions" – "Data Register ROM Backup" in the SmartAXIS Pro/Lite User's Manual.

3: DEVICE ADDRESSES

Special Internal Relays

Special internal relays M8000 through M8177 are used for controlling the CPU operation and communication and for indicating CPU status. All special internal relays cannot be used as destinations of advanced instructions.

Internal relays M300 through M335 are used to read input device status of the IOREF (I/O refresh) instruction.

Note: Do not change the status of reserved special internal relays, otherwise the SmartAXIS may not operate correctly.

Special Internal Relay Device Addresses

Device Address	Description	CPU Stopped	Power OFF	Read/Write	
M8000	Start Control	Maintained	Maintained	Read/Write	
M8001	1-sec Clock Reset	Cleared	Cleared	Write	
M8002	All Outputs OFF	Cleared	Cleared	Write	
M8003	— Reserved —	—	—	—	
M8004	User Program Execution Error	Cleared	Cleared	Read	
M8005	Remote I/O Slave 1 Communication Error	Operating	Cleared	Read	
M8006	Remote I/O Slave 2 Communication Error	Operating	Cleared	Read	
M8007	Remote I/O Slave 3 Communication Error	Operating	Cleared	Read	
M8010	In Daylight Saving Time Period (System version 1.10 or later)	Operating	Cleared	Read	
M8011- M8012	— Reserved —	—	—	—	
M8013	Calendar/Clock Data Write/Adjust Error Flag	Operating	Cleared	Read	
M8014	Calendar/Clock Data Read Error Flag	Operating	Cleared	Read	
M8015	— Reserved —	—	—	—	
M8016	Calendar Data Write Flag	Operating	Cleared	Write	
M8017	Clock Data Write Flag	Operating	Cleared	Write	
M8020	Calendar/Clock Data Write Flag	Operating	Cleared	Write	
M8021	Clock Data Adjust Flag	Operating	Cleared	Write	
M8022- M8024	— Reserved —	—	—	—	
M8025	Maintain Outputs While CPU Stopped	Maintained	Cleared	Read/Write	
M8026	SD Memory Card Status	Maintained	Cleared	Read	
M8027	SD Memory Card Writing Flag	Maintained	Cleared	Read	
M8030	High-speed Counter (Group 1/I0)	Comparison Output Reset	Cleared	Cleared	Read
M8031		Gate Input	Maintained	Cleared	Read
M8032		Reset Input	Maintained	Cleared	Read
M8033		Reset Status	Maintained	Cleared	Read
M8034		Comparison ON Status	Maintained	Cleared	Read
M8035		Overflow	Maintained	Cleared	Read
M8036		Underflow	Maintained	Cleared	Read
M8037		Count Direction	Maintained	Cleared	Read
M8040	High-speed Counter (Group 2/I2)	Comparison Output Reset	Cleared	Cleared	Read
M8041		Gate Input	Maintained	Cleared	Read
M8042		Reset Input	Maintained	Cleared	Read
M8043		Comparison ON Status	Maintained	Cleared	Read
M8044		Overflow	Maintained	Cleared	Read
M8045	High-speed Counter (Group 3/I3)	Comparison Output Reset	Cleared	Cleared	Read
M8046		Gate Input	Maintained	Cleared	Read
M8047		Reset Input	Maintained	Cleared	Read
M8050		Reset Status	Maintained	Cleared	Read
M8051		Comparison ON Status	Maintained	Cleared	Read
M8052		Overflow	Maintained	Cleared	Read
M8053		Underflow	Maintained	Cleared	Read
M8054		Count Direction	Maintained	Cleared	Read

Device Address	Description	CPU Stopped	Power OFF	Read/Write	
M8055	High-speed Counter (Group 4/I5)	Comparison Output Reset	Cleared	Cleared	Read
M8056		Gate Input	Maintained	Cleared	Read
M8057		Reset Input	Maintained	Cleared	Read
M8060		Comparison ON Status	Maintained	Cleared	Read
M8061		Overflow	Maintained	Cleared	Read
M8062- M8075	— Reserved —	—	—	—	
M8076	SD Memory Card Access Stop Flag	Operating	Cleared	Write	
M8077- M8087	— Reserved —	—	—	—	
M8090	Catch Input ON/OFF Status	Group 1/I0	Maintained	Cleared	Read
M8091		Group 2/I2	Maintained	Cleared	Read
M8092		Group 3/I3	Maintained	Cleared	Read
M8093		Group 4/I5	Maintained	Cleared	Read
M8094		Group 5/I6	Maintained	Cleared	Read
M8095		Group 6/I7	Maintained	Cleared	Read
M8096- M8107	— Reserved —	—	—	—	
M8110	Connection Status	Connection 1 (ON: Connected, OFF: Not Connected)	Operating	Cleared	Read
M8111		Connection 2 (ON: Connected, OFF: Not Connected)	Operating	Cleared	Read
M8112		Connection 3 (ON: Connected, OFF: Not Connected)	Operating	Cleared	Read
M8113- M8117	— Reserved —	—	—	—	
M8120	Initialize Pulse	Cleared	Cleared	Read	
M8121	1-sec Clock	Operating	Cleared	Read	
M8122	100-ms Clock	Operating	Cleared	Read	
M8123	10-ms Clock	Operating	Cleared	Read	
M8124	Timer/Counter Preset Value Changed	Maintained	Cleared	Read	
M8125	In-operation Output	Cleared	Cleared	Read	
M8126- M8153	— Reserved —	—	—	—	
M8154	Data Register ROM Backup	Write	Operating	Cleared	Read/Write
M8155		Read	Operating	Cleared	Read/Write
M8156- M8157	— Reserved —	—	—	—	
M8160	Key Input Status	ESC Key + Up Key	Cleared	Cleared	Read
M8161		ESC Key + Down Key	Cleared	Cleared	Read
M8162		ESC Key + Left Key	Cleared	Cleared	Read
M8163		ESC Key + Right Key	Cleared	Cleared	Read
M8164 M8165	— Reserved —	—	—	—	
M8166	High-speed Counter (Group5/I6)	Comparison Output Reset	Cleared	Cleared	Read
M8167		Gate Input	Maintained	Cleared	Read
M8170		Reset Input	Maintained	Cleared	Read
M8171		Comparison ON Status	Maintained	Cleared	Read
M8172		Overflow	Maintained	Cleared	Read
M8173	High-speed Counter (Group 6/I7)	Comparison Output Reset	Cleared	Cleared	Read
M8174		Gate Input	Maintained	Cleared	Read
M8175		Reset Input	Maintained	Cleared	Read
M8176		Comparison ON Status	Maintained	Cleared	Read
M8177		Overflow	Maintained	Cleared	Read

M8000 Start Control

M8000 is used to control the operation of the CPU. The CPU stops operation when M8000 is turned off while the CPU is running. M8000 can be turned on or off using the WindLDR Online menu. When a stop or reset input is designated, M8000 must remain on to control the CPU operation using the stop or reset input.

M8000 maintains its status when the CPU is powered down. When the data to be maintained during power failure is broken after the CPU has been off for a period longer than the battery backup duration, the CPU restarts operation or not as selected in **Configuration > Run/Stop Control > Run/Stop Selection at Memory Backup Error**. For details, see the following manuals.

- Chapter 5 "Special Functions" - "Run/Stop Selection at Memory Backup Error" in the SmartAXIS Pro/Lite User's Manual
- Chapter 3 "Project" - "4 Special Functions" - "4.4 Run/Stop Selection at Memory Backup Error" in the SmartAXIS Touch User's Manual

M8001 1-sec Clock Reset

While M8001 is on, M8121 (1-sec clock) is turned off.

M8002 All Outputs OFF

When M8002 is turned on, all outputs and remote outputs go off until M8002 is turned off. Self-maintained circuits using outputs also go off and are not restored when M8002 is turned off.

M8004 User Program Execution Error

When an error occurs while executing a user program, M8004 turns on. The cause of the user program execution error can be checked using **Online > Monitor > Monitor**, then **Online > Status > Error Status > Details**.

For a list of user program execution errors, see the following manuals.

- Chapter 14 "Troubleshooting" - "User Program Execution Error" in the SmartAXIS Pro/Lite User's Manual
- Chapter 30 "Troubleshooting" - "2 Error Information" in the SmartAXIS Touch User's Manual

M8005 Remote I/O Slave 1 Communication Error

When an error occurs during communication with remote I/O slave 1, M8005 turns on. When the error is cleared, M8005 turns off.

M8006 Remote I/O Slave 2 Communication Error

When an error occurs during communication with remote I/O slave 2, M8006 turns on. When the error is cleared, M8006 turns off.

M8007 Remote I/O Slave 3 Communication Error

When an error occurs during communication with remote I/O slave 3, M8007 turns on. When the error is cleared, M8007 turns off.

M8010 In Daylight Saving Time Period

When the daylight saving time is enabled, M8010 is turned on while in the daylight saving time period. When the daylight saving time is disabled, M8010 is always off.

M8013 Calendar/Clock Data Write/Adjust Error Flag

When an error occurs while calendar/clock data is written or clock data is adjusted, M8013 turns on. If calendar/clock data is written or clock data is adjusted successfully, M8013 turns off.

M8014 Calendar/Clock Data Read Error Flag

When an error occurs while calendar/clock data is read from the internal clock to the special data registers (D8008 to D8014), M8014 turns on. If calendar/clock data is read successfully, M8014 turns off.

M8016 Calendar Data Write Flag

When M8016 is turned on, data in data registers D8015 through D8018 (calendar new data) are set to the internal clock.

M8017 Clock Data Write Flag

When M8017 is turned on, data in data registers D8019 through D8021 (clock new data) are set to the internal clock.

M8020 Calendar/Clock Data Write Flag

When M8020 is turned on, data in data registers D8015 through D8021 (calendar/clock new data) are set to the internal clock.

M8021 Clock Data Adjust Flag

When M8021 is turned on, the clock is adjusted with respect to seconds. If *seconds* are between 0 and 29 for current time, adjustment for *seconds* will be set to 0 and minutes remain the same. If *seconds* are between 30 and 59 for current time, adjustment for *seconds* will be set to 0 and *minutes* are incremented by one.

M8025 Maintain Outputs While CPU Stopped

Outputs are normally turned off when the CPU is stopped. M8025 is used to maintain the output statuses when the CPU is stopped. When the CPU is stopped with M8025 turned on, the output ON/OFF statuses are maintained. When the CPU restarts, M8025 is turned off automatically.

M8026 SD Memory Card Status

When an SD memory card is inserted into the SmartAXIS, M8026 turns on. When an SD memory card is not inserted, M8026 turns off.

M8027 SD Memory Card Writing Flag

While logging data is written to the SD memory card, M8027 turns on. When writing logging data is finished, M8027 turns off.

M8030-M8061 Special Internal Relays for High-speed Counter

Special internal relays used for the high-speed counter.

For details on the high-speed counter, see the following manuals.

- Chapter 5 "Special Functions" - "High-Speed Counter" in the SmartAXIS Pro/Lite User's Manual
- Chapter 3 "4.7 High-Speed Counter" in the SmartAXIS Touch User's Manual

M8076 SD Memory Card Access Stop Flag

Access to the SD memory card stops when M8076 is turned from off to on.

M8090-M8095 Catch Input ON/OFF Status

When a rising or falling input edge is detected during a scan, the input statuses of catch inputs Group 1/I0 through Group 6/I7 at the moment are set to M8090 through M8095, respectively, without regard to the scan status. Only one edge is detected in one scan. For the catch input function, see Chapter 5 "Special Functions" - "Catch Input" in the SmartAXIS Pro/Lite User's Manual.

M8110-M8112 Connection Status

When SmartAXIS and a network device are connected via the maintenance communication server, user communication server/client, or Modbus TCP server/client, the connection status turns on. When no network devices are connected, the connection status turns off.

These relays are always off for the 12-I/O type (SmartAXIS without Ethernet port).

M8120 Initialize Pulse

When the CPU starts operation, M8120 turns on for a period of one scan.

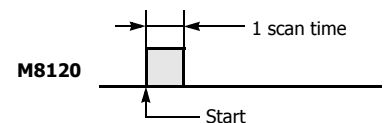

M8121 1-sec Clock

While M8001 (1-sec clock reset) is off, M8121 generates clock pulses in 1-sec increments, with a duty ratio of 1:1 (500 ms on and 500 ms off).

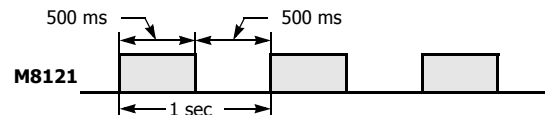

M8122 100-ms Clock

M8122 always generates clock pulses in 100-ms increments, whether M8001 is on or off, with a duty ratio of 1:1 (50 ms on and 50 ms off).

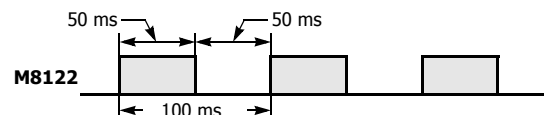

M8123 10-ms Clock

M8123 always generates clock pulses in 10-ms increments, whether M8001 is on or off, with a duty ratio of 1:1 (5 ms on and 5 ms off).

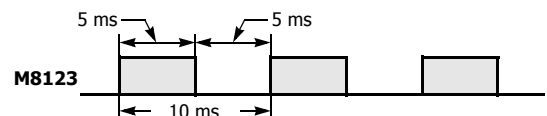

M8124 Timer/Counter Preset Value Changed

When timer/counter preset values are changed in the CPU module RAM, M8124 turns on. When a user program is downloaded to the CPU from WindLDR or when the changed timer/counter preset value is cleared, M8124 turns off.

When a timer or counter is designated as a destination of an advanced instruction, the timer/counter preset value is also changed.

M8125 In-operation Output

M8125 remains on while the CPU is running.

M8154 Write Data Register values to ROM

This special internal relay is used for the data register ROM backup. When M8154 is on at the end of scan, the values of all data registers are written to ROM. After writing values, the execution status is stored in D8133 and M8154 turns off. For details, see Chapter 5 "Special Functions" – "Data Register ROM Backup" in the SmartAXIS Pro/Lite User's Manual.

M8155 In-operation Output

This special internal relay is used for the data register ROM backup. When M8155 turns on at the end of scan, the values in the corresponding ROM are read and stored in the data registers specified by D8184 (start address to read) and D8185 (number of registers to read). After reading values, the execution status is stored in D8133 and M8155 turns off. For details, see Chapter 5 "Special Functions" – "Data Register ROM Backup" in the SmartAXIS Pro/Lite User's Manual.

3: DEVICE ADDRESSES

M8160-M8163 Button Input Status

When the ESC and direction buttons on the SmartAXIS Pro are simultaneously pressed, the corresponding special internal relays M8160 through M8163 turn on. When no buttons are pressed, M8160 through M8163 turn off.

M8166-M8177 Special Internal Relays for High-speed Counter

Special internal relays used for the high-speed counter.

For details on the high-speed counter, see the following manuals.

- Chapter 5 "Special Functions" - "High-Speed Counter" in the SmartAXIS Pro/Lite User's Manual
- Chapter 3 "Project" - "4 Special Functions" - "4.7 High-Speed Counter" in the SmartAXIS Touch User's Manual

Special Data Registers

Note: Do not change the data in any of the reserved special data registers, otherwise the SmartAXIS may not operate correctly.

Special Data Register Device Addresses

Device Address	Description		Updated	See Page
D8000	Quantity of Inputs		When I/O initialized	3-9
D8001	Quantity of Outputs		When I/O initialized	3-9
D8002	SmartAXIS Type Information		Power-up	3-10
D8003	Memory Cartridge Information		Power-up	3-10
D8004	— Reserved —		—	—
D8005	General Error Code		When error occurred	3-10
D8006	User Program Execution Error Code		When error occurred	3-10
D8007	— Reserved —		—	—
D8008	Calendar/Clock Current Data (Read only)	Year	Every 500 ms	3-10
D8009		Month	Every 500 ms	3-10
D8010		Day	Every 500 ms	3-10
D8011		Day of Week	Every 500 ms	3-10
D8012		Hour	Every 500 ms	3-10
D8013		Minute	Every 500 ms	3-10
D8014		Second	Every 500 ms	3-10
D8015		Calendar/Clock New Data (Write only)	Year	—
D8016	Month		—	3-10
D8017	Day		—	3-10
D8018	Day of Week		—	3-10
D8019	Hour		—	3-10
D8020	Minute		—	3-10
D8021	Second		—	3-10
D8022	Scan Time Data		Constant Scan Time Preset Value (1 to 1,000 ms)	—
D8023		Scan Time Current Value (ms)	Every scan	3-10
D8024		Scan Time Maximum Value (ms)	At occurrence	3-10
D8025		Scan Time Minimum Value (ms)	At occurrence	3-10
D8026	Communication Mode Information (Port 2 and Port 3)		Every scan	3-10
D8027	Port 2 Slave Number		Every scan	3-11
D8028	Port 3 Slave Number		Every scan	3-11
D8029	System Software Version		Power-up	3-11
D8030	Communication Adapter Information		Power-up	3-11
D8031	Optional Cartridge Information		Power-up	3-11
D8032-D8038	— Reserved —		—	—
D8039	SD Memory Card Capacity (Megabytes)		Every 1 sec	3-11
D8040	Analog Input Value (AI0)		Every scan	3-11
D8041	Analog Input Value (AI1)		Every scan	3-11
D8042	Analog Input Value (AI2)		Every scan	3-11
D8043	Analog Input Value (AI3)		Every scan	3-11
D8044	Analog Input Value (AI4)		Every scan	3-11
D8045	Analog Input Value (AI5)		Every scan	3-11
D8046	Analog Input Value (AI6)		Every scan	3-11
D8047	Analog Input Value (AI7)		Every scan	3-11
D8048-D8049	— Reserved —		—	—
D8050	High-speed Counter (Group 1/I0)	High Word	Current Value / Frequency Measurement Value (I0)	Every scan
D8051		Low Word		
D8052		High Word	Preset Value	—
D8053		Low Word		
D8054		High Word	Reset Value	—
D8055		Low Word		

3: DEVICE ADDRESSES

Device Address	Description		Updated	See Page	
D8056	High-speed Counter (Group 2/I2)	High Word	Current Value / Frequency Measurement Value (I2)	Every scan	3-11
D8057		Low Word			
D8058		High Word	Preset Value	—	3-11
D8059		Low Word			
D8060		High Word	Reset Value	—	3-11
D8061		Low Word			
D8062	High-speed Counter (Group 3/I3)	High Word	Current Value / Frequency Measurement Value (I3)	Every scan	3-11
D8063		Low Word			
D8064		High Word	Preset Value	—	3-11
D8065		Low Word			
D8066		High Word	Reset Value	—	3-11
D8067		Low Word			
D8068	High-speed Counter (Group 4/I5)	High Word	Current Value / Frequency Measurement Value (I5)	Every scan	3-11
D8069		Low Word			
D8070		High Word	Preset Value	—	3-11
D8071		Low Word			
D8072		High Word	Reset Value	—	3-11
D8073		Low Word			
D8074	Backlight ON Time		Every scan	3-12	
D8075-D8076	— Reserved —		—	—	
D8077	Out of Analog Input Range Status		—	3-12	
D8078	MAC Address (Read only)		Every 1 sec	3-12	
D8079					
D8080					
D8081					
D8082					
D8083					
D8084	IP Address (Current Data) Read only		Every 1 sec	3-12	
D8085					
D8086					
D8087					
D8088	Subnet Mask (Current Data) Read only		Every 1 sec	3-12	
D8089					
D8090					
D8091					
D8092	Default Gateway (Current Data) Read only		Every 1 sec	3-12	
D8093					
D8094					
D8095					
D8096-D8109	— Reserved —		—	—	
D8110	Connection 1 Connected IP Address		Every 1 sec	3-12	
D8111					
D8112					
D8113					
D8114	Connection 2 Connected IP Address		Every 1 sec	3-12	
D8115					
D8116					
D8117					
D8118	Connection 3 Connected IP Address		Every 1 sec	3-12	
D8119					
D8120					
D8121					
D8122-D8129	— Reserved —		—	—	
D8130	Connection 1 Connected Port Number		Every 1 sec	3-12	
D8131	Connection 2 Connected Port Number		Every 1 sec	3-12	
D8132	Connection 3 Connected Port Number		Every 1 sec	3-12	

Device Address	Description		Updated	See Page
D8133	Data Register ROM Backup	Execution Status	When executing data register ROM backup read and write	3-13
D8134	High-speed Counter (Group 5/I6)	High Word	Current Value / Frequency Measurement Value (I6)	Every scan
D8135		Low Word		
D8136		High Word	Preset Value	—
D8137		Low Word		
D8138		High Word	Reset Value	—
D8139		Low Word		
D8140	High-speed Counter (Group 6/I7)	High Word	Current Value / Frequency Measurement Value (I7)	Every scan
D8141		Low Word		
D8142		High Word	Preset Value	—
D8143		Low Word		
D8144		High Word	Reset Value	—
D8145		Low Word		
D8146	— Reserved —		—	—
D8147	— Reserved —		—	—
D8148	Remote I/O Slave 1	Communication Error Status	When error occurred	3-13
D8149		Analog Input (AI10)	Every scan	3-13
D8150		Analog Input (AI11)	Every scan	3-13
D8151		Analog Input (AI12)	Every scan	3-13
D8152		Analog Input (AI13)	Every scan	3-13
D8153		Analog Input (AI14)	Every scan	3-13
D8154		Analog Input (AI15)	Every scan	3-13
D8155		Analog Input (AI16)	Every scan	3-13
D8156		Analog Input (AI17)	Every scan	3-13
D8157	Remote I/O Slave 2	Communication Error Status	When error occurred	3-13
D8158		Analog Input (AI20)	Every scan	3-13
D8159		Analog Input (AI21)	Every scan	3-13
D8160		Analog Input (AI22)	Every scan	3-13
D8161		Analog Input (AI23)	Every scan	3-13
D8162		Analog Input (AI24)	Every scan	3-13
D8163		Analog Input (AI25)	Every scan	3-13
D8164		Analog Input (AI26)	Every scan	3-13
D8165		Analog Input (AI27)	Every scan	3-13
D8166	Remote I/O Slave 3	Communication Error Status	When error occurred	3-13
D8167		Analog Input (AI30)	Every scan	3-13
D8168		Analog Input (AI31)	Every scan	3-13
D8169		Analog Input (AI32)	Every scan	3-13
D8170		Analog Input (AI33)	Every scan	3-13
D8171		Analog Input (AI34)	Every scan	3-13
D8172		Analog Input (AI35)	Every scan	3-13
D8173		Analog Input (AI36)	Every scan	3-13
D8174		Analog Input (AI37)	Every scan	3-13
D8175-D8183	— Reserved —		—	—
D8184	Data Register ROM Backup	Start Address to Read	—	3-13
D8185		Number of Registers to Read	—	3-13
D8186-D8199	— Reserved —		—	—

D8000 Quantity of Inputs

The total of input points provided on the SmartAXIS is stored to D8000.

D8001 Quantity of Outputs

The total of output points provided on the SmartAXIS is stored to D8001.

D8027-D8028 Slave Number

The slave number is stored to D8027 and D8028 when the communication mode for port 2 and 3 is maintenance communication or Modbus RTU slave.

The slave number can be specified with either a constant or a data register in the function area settings. When data register is specified, the slave number can be changed by storing the slave number in D8027 and D8028.

D8027: Port 2 Slave Number

D8028: Port 3 Slave Number

For details on maintenance communication, see Chapter 9 "Maintenance Communication" - "Maintenance Communication via Expansion Communication Port" in the SmartAXIS Pro/Lite User's Manual.

For details on Modbus RTU slaves, see Chapter 11 "Modbus Communication" - "Modbus Communication via RS-232C/RS-485" in the SmartAXIS Pro/Lite User's Manual. For SmartAXIS Touch maintenance communication and Modbus RTU slaves, see Chapter 13 "Troubleshooting" - "Reading Error Data" in the SmartAXIS Pro/Lite User's Manual.

D8029 System Software Version

The PLC system software version number is stored to D8029. This value is indicated in the PLC status dialog box called from the WindLDR menu bar. Select **Online > Monitor > Monitor**, then select **Online > Status**. See Chapter 13 "Troubleshooting" - "Reading Error Data" in the SmartAXIS Pro/Lite User's Manual.

D8030 Communication Adapter Information

Information about the communication adapters installed on the port 2 and port 3 connectors is stored to D8030.

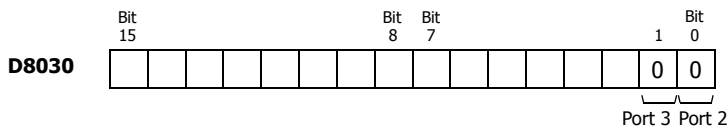

- 0: RS232C communication adapter is installed
- 1: RS485 communication adapter is installed or no communication adapter is installed

D8031 Optional Cartridge Information

Information about the optional cartridge installed on the SmartAXIS is stored to D8031.

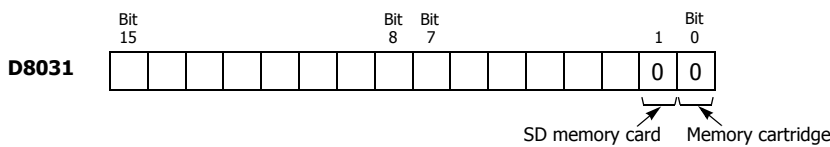

- 0: No optional cartridge is installed
- 1: Memory cartridge is installed
- 2: SD memory card is installed
- 3: Memory cartridge and SD memory card are installed

D8039 SD Memory Card Capacity

The capacity of the inserted SD or SDHC (maximum size 32 GB) memory card in megabytes is stored to D8039.

D8040-D8047 Analog Input Value

The analog input values (0 to 10 VDC) to the analog input terminals are converted to digital values (0 to 1000) and stored to the corresponding special data registers.

Linear conversions can be configured for the analog input (AI) FBs. Even when the linear conversions are configured for AI FBs, the special data registers store the analog values (0 to 1000) before the linear conversions are applied.

D8040=AI0, D8041=AI1, D8042=AI2, D8043=AI3, D8044=AI4, D8045=AI5, D8046=AI6, D8047=AI7

D8050-D8073, D8134-D8145 High-speed Counter and Frequency Measurement

These special data registers are used with the high-speed counter function and the frequency measurement function. For details on the high-speed counter, see the following manuals.

- Chapter 5 "Special Functions" - "High-Speed Counter" in the SmartAXIS Pro/Lite User's Manual
- Chapter 3 "Project" - "4 Special Functions" - "4.7 High-Speed Counter" in the SmartAXIS Touch User's Manual

3: DEVICE ADDRESSES

D8074 Backlight ON Time

The backlight ON time is stored. The backlight ON time can be configured by changing the value in D8074 between 1 to 65,535 seconds. When D8074 is 0, the backlight is always ON. The backlight ON time can also be changed with the HMI function. For details on the HMI function, see Chapter 6 "HMI Function" - "Changing Backlight ON Time" in the SmartAXIS Pro/Lite User's Manual.

D8077 Out of Analog Input Range Status

When an analog input value is 11V or higher, the corresponding D8077 bit turns on. When an analog input value is lower than 11V, the corresponding D8077 bit turns off.

The assignment of each analog input is as follows.

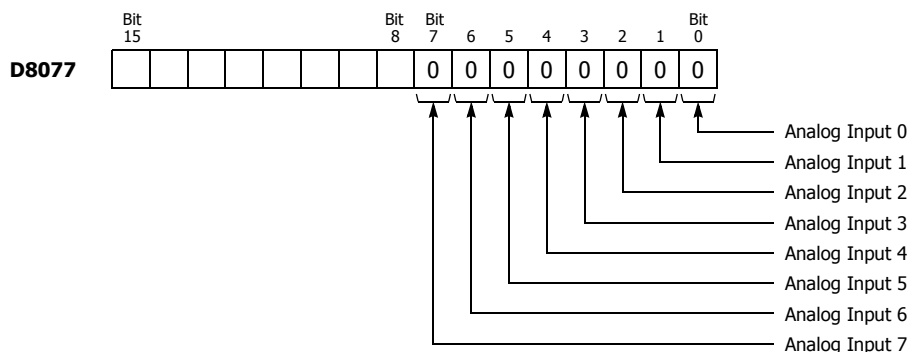

D8078-D8083 MAC Address (Read only)

MAC address of the SmartAXIS is stored to the special data registers in hexadecimal as shown below.

Example) MAC address: AA-BB-CC-DD-EE-FF

D8078=AAh, D8079=BBh, D8080=CCh, D8081=DDh, D8082=EEh, D8083=FFh

D8084-D8087 IP Address (Current Data) Read only

IP address of the SmartAXIS is stored to the special data registers as shown below.

Example) IP address: aaa.bbb.ccc.ddd

D8084=aaa, D8085=bbb, D8086=ccc, D8087=ddd

D8088-D8091 Subnet Mask (Current Data) Read only

Subnet mask of the SmartAXIS is stored to the special data registers as shown below.

Example) Subnet mask: aaa.bbb.ccc.ddd

D8088=aaa, D8089=bbb, D8090=ccc, D8091=ddd

D8092-D8095 Default Gateway (Current Data) Read only

Default gateway of the SmartAXIS is stored to the special data registers as shown below.

Example) Default gateway: aaa.bbb.ccc.ddd

D8092=aaa, D8093=bbb, D8094=ccc, D8095=ddd

D8110-D8121 Connection (1 through 3) Connected IP Address

The IP address of the remote host accessing the connection 1 through 3 is stored in special data registers.

Example) Connection 1 Connected IP Address: aaa.bbb.ccc.ddd

D8110=aaa, D8111=bbb, D8112=ccc, D8113=ddd

D8130-D8132 Connection Connected Port Number

When connections are established with other network devices, the port numbers of the connected network devices are stored in these special data registers.

D8130 : Connection 1 Connected Port Number

D8131 : Connection 2 Connected Port Number

D8132 : Connection 3 Connected Port Number

D8133 Data Register ROM Backup Execution Status

This special data register is used for the data register ROM backup. Stores the execution status for writing and reading.

- 1: Processing
- 2: Normal termination
- 3: Cannot access ROM
- 4: Invalid values are stored in D8184 (starting address to read) and D8185 (number of registers to read)
- 5: Valid data could not be read from ROM

For details, see Chapter 5 "Special Functions" – "Data Register ROM Backup" in the SmartAXIS Pro/Lite User's Manual.

D8148, D8157, D8166 Remote I/O Communication Error Status

When a communication error occurs between the remote I/O communication slave and master, the details of the communication error are stored in these special data registers.

D8148 : Remote I/O Slave 1 Communication Error Status

D8157 : Remote I/O Slave 2 Communication Error Status

D8166 : Remote I/O Slave 3 Communication Error Status

D8149-D8156, D8158-D8165, D8167-D8174 Remote I/O Analog Input Values

The analog input values (0 to 10 VDC) to the remote I/O analog inputs are converted to digital values (0 to 1000) and stored in the special data registers allocated to each remote I/O slave.

Linear conversions can be configured for the analog input (AI) FBs. Even when the linear conversions are configured for AI FBs, the special data registers store the analog values (0 to 1000) before the linear conversions are applied.

- D8149=AI10, D8150=AI11, D8151=AI12, D8152=AI13, D8153=AI14, D8154=AI15, D8155=AI16, D8156=AI17
- D8158=AI20, D8159=AI21, D8160=AI22, D8161=AI23, D8162=AI24, D8163=AI25, D8164=AI26, D8165=AI27
- D8167=AI30, D8168=AI31, D8169=AI32, D8170=AI33, D8171=AI34, D8172=AI35, D8173=AI36, D8174=AI37

D8184 Data Register ROM Backup Start Address to Read

This special data register is used for the data register ROM backup and stores the start address of the data registers to read. For details, see Chapter 5 "Special Functions" – "Data Register ROM Backup" in the SmartAXIS Pro/Lite User's Manual.

D8185 Data Register ROM Backup Number of Registers to Read

This special data register is used for the data register ROM backup and stores the number of data registers to read. For details, see Chapter 5 "Special Functions" – "Data Register ROM Backup" in the SmartAXIS Pro/Lite User's Manual.

4: FB REFERENCE

This chapter describes the SmartAXIS series FB function.

Note: The programming and operations on the SmartAXIS FBD program require specialist knowledge.

To make effective use of the SmartAXIS, take the time to develop a thorough understanding of the contents in this manual and the programming.

FB List

Input FB

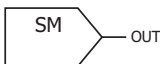
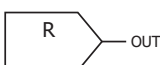
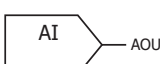
Symbol	Name and Diagram	Function	Output Inversion	Refer to
I	Digital Input 	Inputs ON/OFF information from an external to the SmartAXIS.	–	5-1
SM	Special Internal Relay 	Special internal relays can be used as bit inputs for FBs in the SmartAXIS. Special function is allocated to each special internal relay. For details on the individual special internal relays, see "Device Addresses" - "Special Internal Relay Device Addresses" on page 3-2.	–	5-2
R	Shift Register 	Outputs ON/OFF state of a shift register device.	–	5-3
AI	Analog Input 	The analog input values (0 to 10V DC) for the analog input terminals are converted to digital values (0 to 1,000) and output. With the analog input linear conversion function, the analog input value can be linearly conversion within a range of -32,768 to 32,767.	–	5-4

Output FB

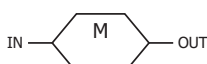
Symbol	Name and Diagram	Function	Output Inversion	Refer to
Q	Digital Output 	Outputs ON/OFF information from the SmartAXIS to an external device.	–	6-1
M	Internal Relay 	A bit unit FB used internally by the SmartAXIS.	–	6-2

4: FB REFERENCE

Logical Operation FB

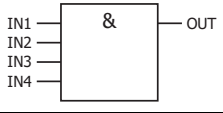
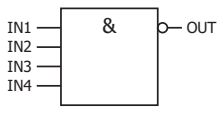
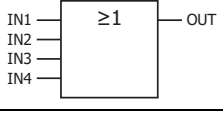
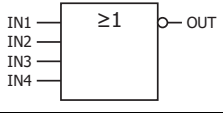
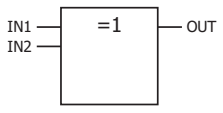
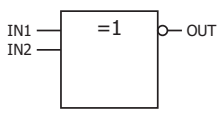
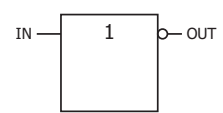
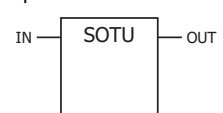
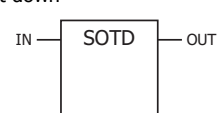
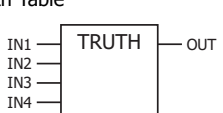
Symbol	Name and Diagram	Function	Output Inversion	Refer to
AND	Logical AND 	Implements logical AND for a maximum of four input signals (ON/OFF) and outputs the result.	–	7-1
NAND	Negative Logical AND 	Implements negative logical AND for a maximum of four input signals (ON/OFF) and outputs the result.	–	7-2
OR	Logical OR 	Implements logical OR for a maximum of four input signals (ON/OFF) and outputs the result.	–	7-3
NOR	Negative Logical OR 	Implements negative logical OR for a maximum of four input signals (ON/OFF) and outputs the result.	–	7-4
XOR	Exclusive Logical OR 	Implements exclusive logical OR for a maximum of two input signals (ON/OFF) and outputs the result.	–	7-5
XNOR	Negative Exclusive Logical OR 	Implements negative exclusive logical OR for a maximum of two input signals (ON/OFF) and outputs the result.	–	7-6
NOT	Negation 	Outputs the result of negating the input signal (ON/OFF).	–	7-7
SOTU	Shot up 	Turns on the output for one scan when the input signal turns from off to on.	–	7-8
SOTD	Shot down 	Turns on the output for one scan when the input signal turns from on to off.	–	7-9
TRUTH	Truth Table 	A truth table for the output can be configured corresponding to the 16 patterns combination of the four input signals, and TRUTH FB outputs the result according to the table.	X	7-10

Timer FB

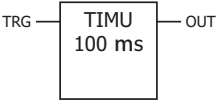
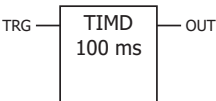
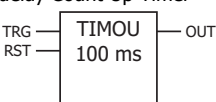
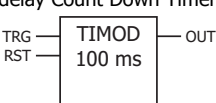
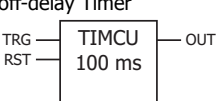
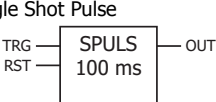
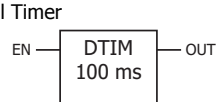
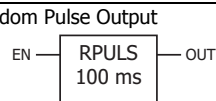
Symbol	Name and Diagram	Function	Output Inversion	Refer to
TIMU	On-delay Count Up Timer 	After the execution input turns on, the output turns on when the on-delay time elapses. The current value is incremented from zero to the preset value.	–	8-1
TIMD	On-delay Count Down Timer 	After the execution input turns on, the output turns on when the on-delay time elapses. The current value is decremented from the preset value to zero.	–	8-5
TIMOU	Off-delay Count Up Timer 	When the execution input turns on, the output turns on. After the execution input turns off, the output turns off when the off-delay time elapses. The current value is incremented from zero to the preset value.	–	8-7
TIMOD	Off-delay Count Down Timer 	When the execution input turns on, the output turns on. After the execution input turns off, the output turns off when the off-delay time elapses. The current value is decremented from the preset values to zero.	–	8-9
TIMCU	On/off-delay Timer 	After the execution input turns on, the output turns on when the on-delay time elapses. After the execution input turns off, the output turns off when the off-delay time elapses.	–	8-11
SPULS	Single Shot Pulse 	After the execution input turns on, the output turns on for the configured time period.	–	8-14
DTIM	Dual Timer 	The output is turned on and off according to the configured ON and OFF time.	–	8-16
RPULS	Random Pulse Output 	The output is turned on for the length of random time within the configured range of time.	–	8-19

Counter FB

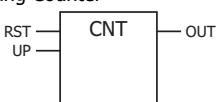
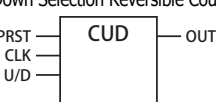
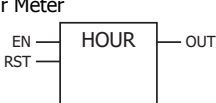
Symbol	Name and Diagram	Function	Output Inversion	Refer to
CNT	Adding Counter 	When the clock input is turned on, the current value is incremented by one. The output turns on when the current value reaches the preset value.	–	9-1
CUD	Up/Down Selection Reversible Counter 	When the clock input is turned on, the current value is incremented or decremented by one according to the up/down selection input. The current value is compared with ON/OFF thresholds. The output turns on or off according to the comparison result.	–	9-3
HOUR	Hour Meter 	Accumulates the ON duration of the execution input in hours, minutes, and seconds. The output turns on when the accumulated time reaches the configured time.	–	9-7

4: FB REFERENCE

Shift Register FB

Symbol	Name and Diagram	Function	Output Inversion	Refer to
SFR	Shift Register 	When the execution input turns on, the shift registers are shifted to the specified shift direction.	X	10-1

Data Comparison FB

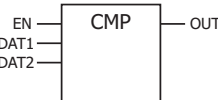
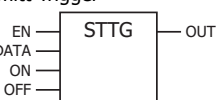
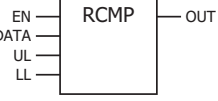
Symbol	Name and Diagram	Function	Output Inversion	Refer to
CMP	Data Comparison 	Two inputs values are compared and the output turns on or off according to the comparison result.	X	11-1
STTG	Schmitt Trigger 	The comparison input value and the ON/OFF thresholds are compared and the output turns on or off according to the comparison result.	X	11-3
RCMP	Range Comparison 	The comparison input value and the upper/lower limits are compared and the output turns on or off according to the comparison result.	X	11-5

Data Conversion FB

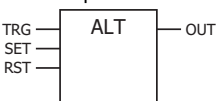
Symbol	Name and Diagram	Function	Output Inversion	Refer to
ALT	Alternate Output 	Sets/resets the output.	X	12-1

Week Programmer FB

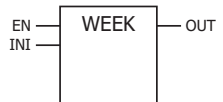
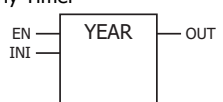
Symbol	Name and Diagram	Function	Output Inversion	Refer to
WEEK	Weekly Timer 	Compares the specified day of the week, ON time, and OFF time with the current time and outputs the result.	-	13-1
YEAR	Yearly Timer 	Compares the specified date with the current date and outputs the result.	-	13-13

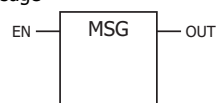

Interface FB

Symbol	Name and Diagram	Function	Output Inversion	Refer to
MSG	Message 	Displays data such as text and device values on the LCD on the SmartAXIS Pro.	X	14-1

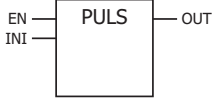
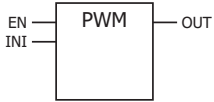
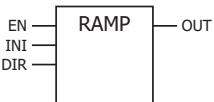
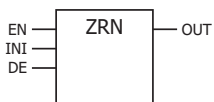
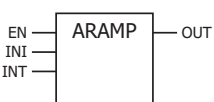
Pulse FB

Symbol	Name and Diagram	Function	Output Inversion	Refer to
PULS	Pulse Output 	Outputs pulses at the specified frequency.	X	15-1
PWM	Pulse Width Modulation 	Outputs pulses at the specified frequency and duty cycle.	X	15-6
RAMP	Ramp Pulse Output 	Outputs pulses with the frequency change function.	X	15-11
ZRN	Zero Return 	Outputs pulses with the different pulse frequency corresponding to the on/off state of a deceleration signal.	X	15-21
ARAMP	Advanced Ramp 	Output pulses with the frequency change function according to the settings configured in the frequency table.	X	15-26

Data Logging FB

Symbol	Name and Diagram	Function	Output Inversion	Refer to
DLOG	Data Log 	Saves the values of the specified devices in the specified data format as a CSV file to the SD memory card.	–	16-1
TRACE	Data Trace 	Saves the values of the previous number of scans for the specified device in the specified data format as a CSV file to the SD memory card.	–	16-8

Script FB

Symbol	Name and Diagram	Function	Output Inversion	Refer to
SCRPT	Script 	Enables you to program complicated processing with the script language that supports conditional branching, logical operations, arithmetic operations, and functions.	–	17-1

4: FB REFERENCE

Special FB

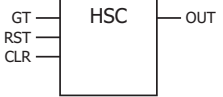
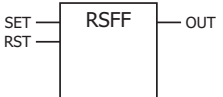
Symbol	Name and Diagram	Function	Output Inversion	Refer to
HSC	<p>High-speed Counter</p> 	Operates the high-speed counter configured in the function area settings. Turns on/off the high-speed counter gate input/reset input/clear input.	X	18-1
RSFF	<p>RS Flip-flop</p> 	When the set input turns on, the output turns on and keeps on. When the reset input turns on, the output turns off.	X	18-3

Advanced Instruction Applicable SmartAXIS

FB			Applicable SmartAXIS								
			FT1A-12		FT1A-24		FT1A-40		FT1A-48		FT1A Touch
Group	Name	Symbol	AC	DC	AC	DC	AC	DC	AC	DC	
Input	Digital Input	I	X	X	X	X	X	X	X	X	X
	Special Internal Relay	M	X	X	X	X	X	X	X	X	X
	Shift Register	R	X	X	X	X	X	X	X	X	X
	Analog Input	AI	X	X	X	X	X	X	X	X	X
Output	Digital Output	Q	X	X	X	X	X	X	X	X	X
	Internal Relay	M	X	X	X	X	X	X	X	X	X
Logical Operation	Logical AND	AND	X	X	X	X	X	X	X	X	X
	Negative Logical AND	NAND	X	X	X	X	X	X	X	X	X
	Logical OR	OR	X	X	X	X	X	X	X	X	X
	Negative Logical OR	NOR	X	X	X	X	X	X	X	X	X
	Exclusive Logical OR	XOR	X	X	X	X	X	X	X	X	X
	Negative Exclusive Logical OR	XNOR	X	X	X	X	X	X	X	X	X
	Negation	NOT	X	X	X	X	X	X	X	X	X
	Shot up	SOTU	X	X	X	X	X	X	X	X	X
	Shot down	SOTD	X	X	X	X	X	X	X	X	X
	Truth Table	TRUTH	X	X	X	X	X	X	X	X	X
Timer	On-delay Count Up Timer	TIMU	X	X	X	X	X	X	X	X	X
	On-delay Count Down Timer	TIMD	X	X	X	X	X	X	X	X	X
	Off-delay Count Up Timer	TIMOU	X	X	X	X	X	X	X	X	X
	Off-delay Count Down Timer	TIMOD	X	X	X	X	X	X	X	X	X
	On/off-delay Timer	TIMCU	X	X	X	X	X	X	X	X	X
	Single Shot Pulse	SPULS	X	X	X	X	X	X	X	X	X
	Dual Timer	DTIM	X	X	X	X	X	X	X	X	X
	Random Pulse Output	RPULS	X	X	X	X	X	X	X	X	X
Counter	Adding Counter	CNT	X	X	X	X	X	X	X	X	X
	Up/Down Selection Reversible Counter	CUD	X	X	X	X	X	X	X	X	X
	Hour Meter	HOUR	X	X	X	X	X	X	X	X	X
Shift Register	Shift Register	SFR	X	X	X	X	X	X	X	X	
Data Comparison	Data Comparison	CMP	X	X	X	X	X	X	X	X	X
	Schmitt Trigger	STTG	X	X	X	X	X	X	X	X	X
	Range Comparison	RCMP	X	X	X	X	X	X	X	X	X
Data Conversion	Alternate Output	ALT	X	X	X	X	X	X	X	X	X
Week Programmer	Weekly Timer	WEEK	X	X	X	X	X	X	X	X	X
	Yearly Timer	YEAR	X	X	X	X	X	X	X	X	X
Interface	Message	MSG	X (Note 1)	X (Note 1)	X (Note 1)	X (Note 1)	X (Note 1)	X (Note 1)	X (Note 1)	X (Note 1)	-
Pulse	Pulse Output	PULS	-	-	-	-	-	X (Note 2)	X	X	-
	Pulse Width Modulation	PWM	-	-	-	-	-	X (Note 2)	X	X	-
	Ramp Pulse Output	RAMP	-	-	-	-	-	X (Note 3)	X (Note 3)	X (Note 3)	-
	Zero Return	ZRN	-	-	-	-	-	X	X	X	-
	Advanced Ramp	ARMP	-	-	-	-	-	X (Note 3)	X (Note 3)	X (Note 3)	-
Data Logging	Data Log	DLOG	-	-	-	-	X	X	X	X	-
	Data Trace	TRACE	-	-	-	-	X	X	X	X	-
Script	Script	SCRPT	X	X	X	X	X	X	X	X	X
Special	High-speed Counter	HSC	-	X	-	X	-	X	-	X	X
	RS Flip-flop	RSFF	X	X	X	X	X	X	X	X	X

Note 1: The MSG FB can be used only with SmartAXIS Pro.

Note 2: When using RAMP1 in single-pulse output mode, PULS3 and PWM3 cannot be used. When using RAMP2 in single-pulse output mode, PULS4 and PWM4 cannot be used.

Note 3: When using RAMP1 or ARAMP1 in dual-pulse output mode, RAMP2 or ARAMP2 cannot be used.

Applicable Data Types

FB			Data type				
Group	Name	Symbol	W Word	I Integer	D Double word	L Long	F Float
Input	Digital Input	I	-	-	-	-	-
	Special Internal Relay	M	-	-	-	-	-
	Shift Register	R	-	-	-	-	-
	Analog Input	AI	X ^{*1}	X ^{*1}	-	-	-
Output	Digital Output	Q	-	-	-	-	-
	Internal Relay	M	-	-	-	-	-
Logical Operation	Logical AND	AND	-	-	-	-	-
	Negative Logical AND	NAND	-	-	-	-	-
	Logical OR	OR	-	-	-	-	-
	Negative Logical OR	NOR	-	-	-	-	-
	Exclusive Logical OR	XOR	-	-	-	-	-
	Negative Exclusive Logical OR	XNOR	-	-	-	-	-
	Negation	NOT	-	-	-	-	-
	Shot up	SOTU	-	-	-	-	-
	Shot down	SOTD	-	-	-	-	-
	Truth Table	TRUTH	-	-	-	-	-
Timer	On-delay Count Up Timer	TIMU	X	-	-	-	-
	On-delay Count Down Timer	TIMD	X	-	-	-	-
	Off-delay Count Up Timer	TIMOU	X	-	-	-	-
	Off-delay Count Down Timer	TIMOD	X	-	-	-	-
	On/off-delay Timer	TIMCU	X	-	-	-	-
	Single Shot Pulse	SPULS	X	-	-	-	-
	Dual Timer	DTIM	X	-	-	-	-
	Random Pulse Output	RPULS	X	-	-	-	-
Counter	Adding Counter	CNT	X	-	X	-	-
	Up/Down Selection Reversible Counter	CUD	X	-	X	-	-
	Hour Meter	HOUR	X	-	-	-	-
Shift Register	Shift Register	SFR	-	-	-	-	-
Data Comparison	Data Comparison	CMP	X	X	X	X	-
	Schmitt Trigger	STTG	X	X	X	X	-
	Range Comparison	RCMP	X	X	X	X	-
Data Conversion	Alternate Output	ALT	-	-	-	-	-
Week Programmer	Weekly Timer	WEEK	-	-	-	-	-
	Yearly Timer	YEAR	-	-	-	-	-
Interface	Message	MSG	X	X	X	X	X
Pulse	Pulse Output	PULS	-	-	-	-	-
	Pulse Width Modulation	PWM	-	-	-	-	-
	Ramp Pulse Output	RAMP	-	-	-	-	-
	Zero Return	ZRN	-	-	-	-	-
	Advanced Ramp	ARMP	-	-	-	-	-
Data Logging	Data Log	DLOG	X	X	X	X	X
	Data Trace	TRACE	X	X	X	X	X
Script	Script	SCRPT	X	X	X	X	X
Special	High-speed Counter	HSC	X	-	X	-	-
	RS Flip-flop	RSFF	-	-	-	-	-

*1 When using the analog input cartridge (AI2 to AI5) of the Touch (transistor output type), configure the data type of AI FB in the function area settings. For configuring the function area settings, see Chapter 3 "4.15 Analog Cartridge" in the "SmartAXIS Touch User's Manual".

FB Specifications

This section describes the FB specifications.

Basic FB configuration

All FBs are composed of a FB symbol, input connectors (4 maximum), an output connector, and a block number. FBs operate according to the state of the input connectors and the internal parameters of the FB, and output the result from the output connector.

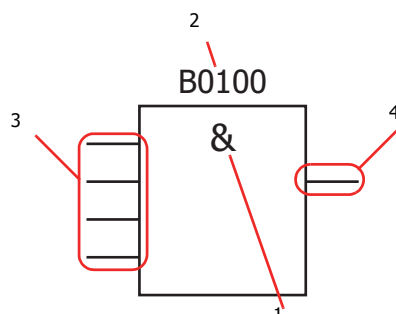

Name		Description
1	FB symbol	The symbol that indicates the FB type.
2	Block number (device address)	Unique number to identify each function block. The block number is automatically assigned in ascending order from zero. The block number can be changed to a desired number. However, the block numbers already used in any other FBs cannot be used. If a tag name and comment are configured for the device address, they are also displayed.
3	Input connector	Connectors for inputting the output states of other FBs to the FB. Connect the output connectors of the other FBs to these input connectors. The type of output connector (bit/analog) can be connected varies depending on the input connectors of each FB. Depending on each input connector, FBs may be used with the input connectors unconnected. For details, see the descriptions of each FB. Input connectors receiving a bit state can be configured as Inverted so that the inverted bit state can be input to the FB.
4	Output connector	The connector for outputting the result of the FB operation. FBs have only a single bit output (on/off) or an analog output. The result of the FB operation can be input to another FB by connecting the output connector to an input connector of the FB. If the output connector is bit output, the result of the FB operation can be inverted and output. For the list of FBs that support output inversion, see "FB List" on page 4-1. Output connectors of FBs other than the output FBs (digital output/internal relay) must be connected to the input connectors of other FBs.

FB devices

This list shows the devices that can be used in FBD programs.

Symbol	Name	Attributes in FBD programs	Description
I	Digital Input	R	Devices for incorporating on/off information from external devices to the SmartAXIS. The state can be changed by changing the state of the external input or by the forced I/O function*1.
Q	Digital Output	R/W	Devices for outputting on/off information from the SmartAXIS to external devices. The state can be changed with the forced I/O function*1, the FBD program, or the SCRPT FB.
M	Internal Relay	R/W	Devices for receiving FB output internally. To incorporate the output results of a FB as looped-back input, insert an internal relay in between the output connector and the input connector of the FB. The state can be changed with a FBD program or the SCRPT FB.
M	Special Internal Relay	R	Devices for referring to special internal relays. The state can be changed with the SCRPT FB.
R	Shift Register	R	Bit devices used with the SFR FB. The state can be changed with the SFR FB and the SCRPT FB.
AI	Analog Input	R	Devices for incorporating analog input signals from external devices the SmartAXIS.
T	Timer	R	Timers used internally in the SmartAXIS. These are used with the timer FBs.
C	Counter	R	Counters used internally in the SmartAXIS. These are used with the counter FBs.
D	Data Register	–	Word devices used for storing numeric data. The value can be changed with the SCRPT FB.
B	Block Relay	R	Devices that indicate the output state of FBs other than timers and counters.

*1 Using WindLDR, inputs and outputs can be forcibly turned on and off. For details, see Chapter 5 "Special Functions" - "Forced I/O Function" in the SmartAXIS Pro/Lite User's Manual.

4: FB REFERENCE

Notes:

- Devices refer to memory areas that are prepared in advanced for specific purposes in the SmartAXIS, and they are identified by the device type I, Q, M, R, AI, T, C, D, and B and the address. Device values refer to the values stored in the memory areas specified by the device addresses.
- Devices that can be configured vary depending on each FB parameter. You may also be able to configure constants instead of devices.
- For details on SmartAXIS device types, see "Device Addresses" on page 3-1.

Data types

When using counter FBs, comparison FBs data logging FBs, and script FBs, the data type can be set. Arithmetic operations can be performed on a variety of data by specifying the data type.

■ Data type W (word), I (integer), D (double word), L (long)

The unit and range of data that can be processed with data type W (word), I (integer), D (double word), and L (long) is as follows.

Data Type		Number of Used Data Registers	Processable unit	Data Range
Abbreviation	Name			
W	Word	1	Unsigned 16 bits	0 - 65,535
I	Integer	1	Signed 15 bits	-32,768 - 32,767
D	Double word	2	Unsigned 32 bits	0 - 4,294,967,295
L	Long	2	Signed 31 bits	-2,147,483,648 - 2,147,483,647

- For the data types that can be used with each FB, see "Applicable Data Types" on page 4-8.

Storage Method of 32-bit Data

32-bit D (double word) and L (long word) type data is stored in devices in the following manner according to the selection in **Function Area Settings** under **Device Settings**.

For applicable devices and FBs, see Chapter 5 "Special Functions" - "Storage Method of 32-bit Data" in the SmartAXIS Pro/Lite User's Manual.

Word device: When **From Upper Word** is selected under **Device Settings**.

When D0000 is specified as the storage location, the upper word is stored in D0000 and the lower word is stored in D0001.

Double word data (constant)

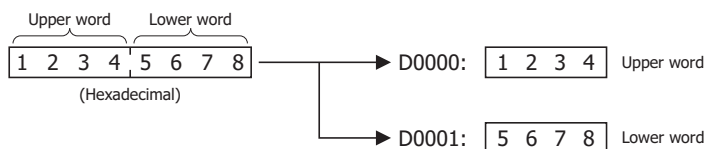

When **From Lower Word** is selected under **Device Settings**.

When D0000 is specified as the storage location, the lower word is stored in D0000 and the upper word is stored in D0001.

Double word data (constant)

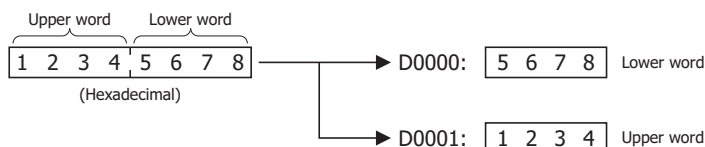

Bit device:

When R000 is specified as the storage location, the lower word is stored in the range R000 - R015 and the upper word is stored in the range R016-R031.

Double word data (constant)

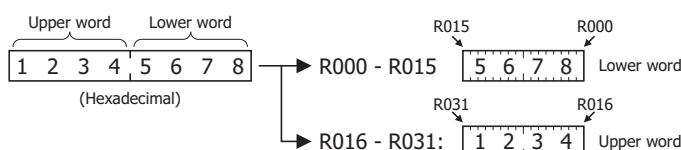

■ Data Type F (Float)

Handling numeric values in floating point arithmetic operations

With the SmartAXIS series, F (float), which means the floating point type, can be specified as the data type for FBs that use floating point. For FBs that use floating point, two consecutive data registers starting from the specified data register are used as a pair in the same manner as the integer types D (double word) and L (long). The SmartAXIS series floating point type data format conforms to the IEEE (US Institute of Electrical and Electronics Engineers) standard for the single precision storage format as explained next.

Single precision floating point values in IEEE 754 (32 bits)

Single precision floating point values in IEEE 754 are expressed with a total of 32 bits (2 words) using 1 bit for the sign *s*, 8 bits for the exponent *e*, and 23 bits for the significand *f*. The sign bit indicates the sign of the expressed value (positive or negative). The exponent is an 8 bit signed integer with a value from -126 to 127.

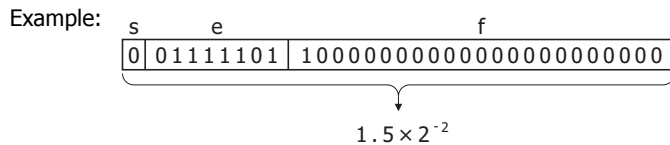
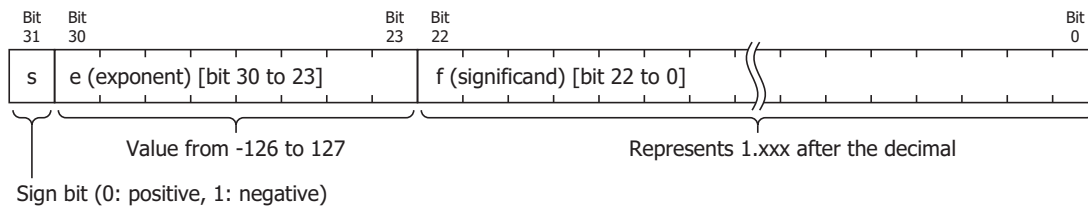

The table below shows the correspondence between values in the three fields of *s*, *e*, and *f*, and the value expressed as a single precision floating point value. When a value other than a normal number or 0 is input to a FB that uses floating point, a user program execution error occurs and special internal relay M8004 (user program execution error) turns on.

Value	Exponent <i>e</i>	Significand <i>f</i>	Representation in WindLDR
±0	e=0	f=0	0.0
Denormal numbers	e=0	f>0	-1.175494E-38 to 1.175494E-38
Normal numbers	0<e<255	Arbitrary	-3.402823E+38 to -1.175494E-38 1.175494E-38 to 3.402823E+38
±∞ (± infinity)	e=255	f=0	INF
Not a Number		f>0	NAN

4: FB REFERENCE

Inverting FB input/output

The state of the FB output connector connected to an input connector can be inverted and incorporated. The inverted input value to the FB is the same as when the NOT FB (negation FB) is connected immediately before the input connector. The result of the FB operation can also be inverted and output. At that time, the output value from the FB is the same as when the NOT FB (negation FB) is connected immediately after the output connector.

Input inversion

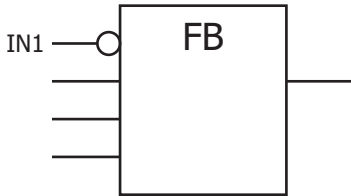

Output of FB connected to IN1	State of IN1 incorporated in FB
ON	OFF
OFF	ON

Output inversion

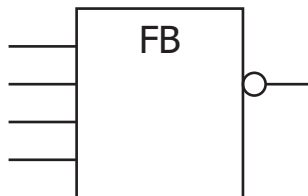

FB operation result	FB output
ON	OFF
OFF	ON

FB analog input

The SmartAXIS is equipped with analog input ports. Analog values input to the analog input ports can be processed in FBD programs. FBs that can handle analog values as input are the CMP (Data Comparison), STTG (Schmitt Trigger), and RCMP (Range Comparison) FBs.

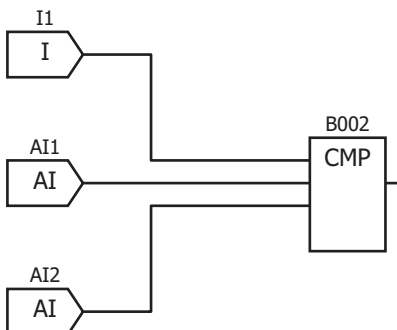

The CMP FB in the above FBD program compares analog input AI1 with AI2 and outputs the result when input I1 is on.

Note:

- The comparison FBs (CMP/STTG/RCMP) are capable of handling data of data type W (word), I (integer), D (double word), and L (long), but output from analog input FBs can only be connected when the comparison FB data type is I (integer).
- When handling analog input values as FB input, use the analog input (AI) FB. Analog input values (0 to 1000) can be linearly converted in the range of -32768 to 32767 using the AI FB. For details on the AI FB, see "The input FB" on page 5-1.
- The analog values before the linear conversion are stored in special data registers (D8040 to D8047, D8149 to D8156, D8158 to D8165, D8167 to D8174). For details, see "Device Addresses" on page 3-1.

FB input/output connectors and parameters

This section describes FB input/output connectors and parameters. The function of the connectors and parameters can be identified by the symbols. The list of symbols, their descriptions, and data formats are shown next.

Input connector

Symbol	Description	Input format
IN	Input	ON/OFF
EN, TRG	Execution input	ON/OFF
SET	Set input	ON/OFF
RST	Reset input	ON/OFF
PRST	Preset input	ON/OFF
UP	Up clock input	ON/OFF
CLK	Clock input	ON/OFF
U/D	Up/down selection input	ON/OFF
DI	Data input	ON/OFF
DIR	Control direction input	ON/OFF
INI	Initialization input	ON/OFF
DE	Deceleration signal input	ON/OFF
INT	Interrupt input	ON/OFF
DAT, DATA	Comparison value	Analog
UL	Upper limit	Analog
LL	Lower limit	Analog
ON	ON threshold	Analog
OFF	OFF threshold	Analog

Output connector

Symbol	Description	Input format
OUT	Output	ON/OFF
AOUT	Analog output	Analog

Parameter

Symbol	Description
MIN	Linear conversion minimum
MAX	Linear conversion maximum
S1, S2	Control register, folder name, script ID, number of parameter tabs
D1, D2	Operation status, monitor register, execution status, execution result
TP	Timer FB preset value
TU	Time unit
CP	Counter FB preset value
OP	Operation mode, data type, high-speed counter group
R	Start shift register
N, n	Number of constituent bits, pulse output port number
PRI	Priority

4: FB REFERENCE

FB connection lines

The lines that connect FB input connectors and output connectors are called connection lines. FB input connectors can be connected to the output connectors of other FBs, but more than one output connectors cannot be connected to a single input connector. In this situation, use a logical operation FB as shown in the following example.

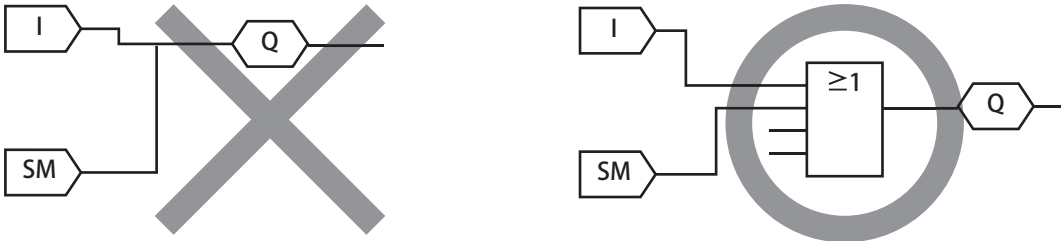

The FB output connector can be connected to more than one input connectors of the other FBs. There is no limit to the number of input connectors that an output connector can be connected to.

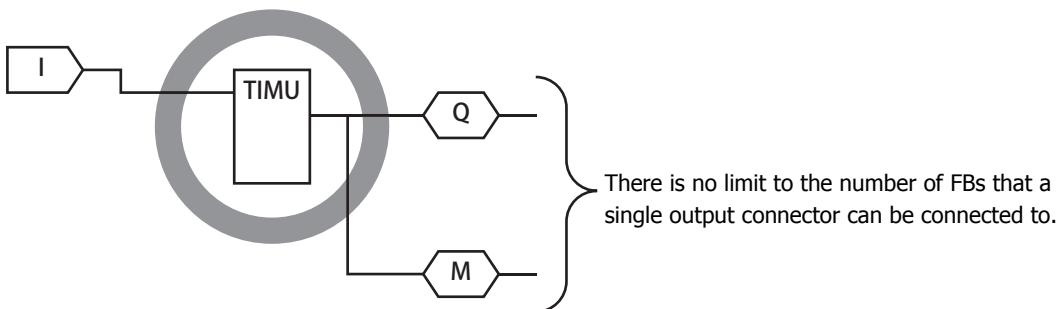

Note:

- The output connector for bit output (on/off) cannot be connected to an analog input connector.
- FB input connectors cannot be connected each other and FB output connectors also can not be connected each other.
- To incorporate the output results of a FB as looped-back input, an output FB (digital output/internal relay) must be inserted in between the output connector and the input connector of the FB.

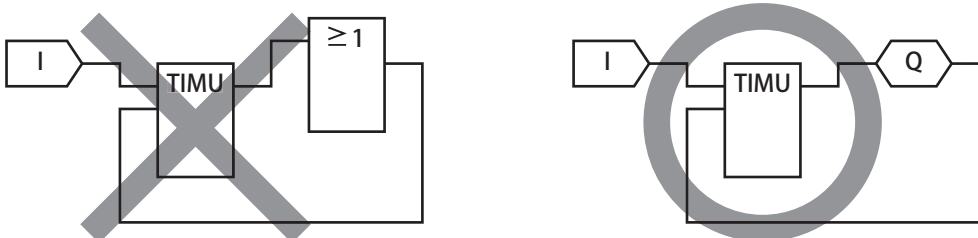

FBD programs

FBD program

A group of FBs connected to an output FB is called a circuit block. The minimum configuration of a circuit block is composed of an input FB and an output FB. The FB operation results are passed to FBs connected by the connection line. The group of all circuit blocks created in the program is called the FBD program.

Example of a minimum configuration of a circuit block:

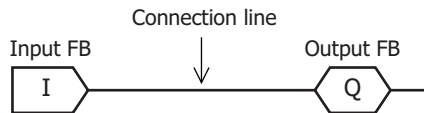

Scan time

In the FBD program, the processing to execute all of the programmed FBs is called one scan, and the time required to execute the program for one scan is called the scan time.

FBD program execution

For FBD programs, all of the FBs composing circuit blocks and connected to an output FB (digital output/internal relay) are executed sequentially from the input FBs. FBs other than the input FBs incorporate the operation results of the other FBs connected to the input connectors, process the operation, and output the result from the output connector. The FBs are executed in order from the FBs connected to the input FBs, and the execution of a single circuit block is complete when the data is passed to the output FB (digital output/internal relay). When all the circuit blocks have completed executing, program execution for one scan is complete.

Note:

- After the Q0, Q1, and Qx circuit blocks have executed, the circuit blocks are executed in M0000, M0001, and Mx order.
- FBs that are not connected to output FBs (digital output/internal relay), in other words, the FBs that do not compose a circuit block are not executed.
- For input FBs, the most recent input state acquired by refreshing the I/O at the end of the scan is output from the output connector.
- Output connectors of output FBs (digital output/internal relay) can be connected to the input connectors of the other FBs. Output from the output connector of output FBs is the state of the output FB in the previous scan. For example, in the FBD program in the following diagram, Q4 turns on four scans after I10 turns on.

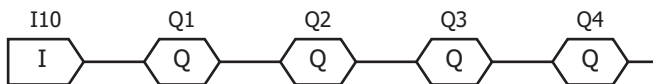

To turn on all the output FBs simultaneously when I10 is turned on, created a FBD program as shown in the following diagram.

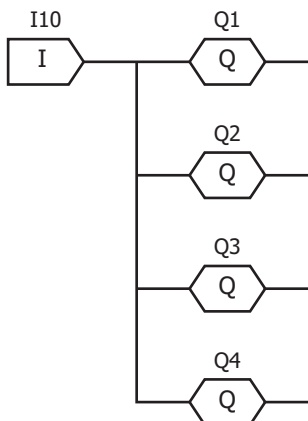

5: THE INPUT FB

This chapter describes the input FB of the SmartAXIS series.

I (Digital Input)

A function block to use the state (on/off) of a digital input.

Symbol

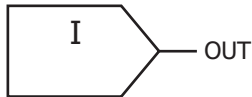

Operation

The digital input FB outputs the on/off state of the digital input. Specify a digital input number to the FB.

Applicable SmartAXIS

FT1A-12	FT1A-24	FT1A-40	FT1A-48	FT1A Touch
X	X	X	X	X

Parameters

Parameter	Function	Range	Description
Number	I	Input number	Unique number to identify the digital input function block. Specify a digital input number. However, the digital input numbers already used in any other digital input FBs cannot be used.
Input	–	–	–
Output	OUT	Output	Outputs the on/off state of the specified digital input.
Parameters	–	–	–

*1 The range for the digital input varies depending on the SmartAXIS type.

Product series	Digital input (I)
12-I/O type	I0 to I7 (8 inputs)
24-I/O type	I0 to I17 (16 inputs), I40 to I75 (30 inputs), I80 to I115 (30 inputs), I120 to I155 (30 inputs)
40-I/O type	I0 to I27 (24 inputs), I40 to I75 (30 inputs), I80 to I115 (30 inputs), I120 to I155 (30 inputs)
48-I/O type	I0 to I35 (30 inputs), I40 to I75 (30 inputs), I80 to I115 (30 inputs), I120 to I155 (30 inputs)
Touch	I0 to I7 (8 inputs)

SM (Special Internal Relay)

A function block to use the state (on/off) of a special internal relay.

Symbol

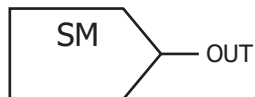

Operation

The special internal relay FB outputs the on/off state of the special internal relay. Specify a special internal relay number to the FB.

Note: For special internal relay numbers and functions, see "Device Addresses" on page 3-1.

Applicable SmartAXIS

FT1A-12	FT1A-24	FT1A-40	FT1A-48	FT1A Touch
X	X	X	X	X

Parameters

Parameter		Function	Range	Description
Number	M	Internal relay number	M8000 to M8177	Unique number to identify the special internal relay function block. Specify a special internal relay number. However, the special internal relay numbers already used in any other special internal relay FBs cannot be used.
Input	-	-	-	-
Output	OUT	Output	-	Outputs the on/off state of the specified special internal relay.
Parameters	-	-	-	-

R (Shift Register)

A function block to use the state (on/off) of a shift register.

Symbol



Operation

The shift register FB outputs the on/off state of the shift register. Specify a shift register number to the FB.

Note: Operations on the shift register are performed with the SFR FB. For the SFR FB, see "The shift register FB" on page 10-1.

Applicable SmartAXIS

FT1A-12	FT1A-24	FT1A-40	FT1A-48	FT1A Touch
X	X	X	X	X

Parameters

Parameter	Function	Range	Description
Number	R	Shift register number	Unique number to identify the shift register function block. Specify a shift register number. However, the shift register numbers already used in any other shift register FBs cannot be used.
Input	–	–	–
Output	OUT	Output	Outputs the on/off state of the specified shift register.
Parameters	–	–	–

AI (Analog Input)

Linearly converts the analog input value (0 to 1000) and outputs the converted value.

Symbol

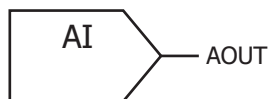

Operation

The analog input FB linearly converts the analog input value (0 to 1000) and outputs the converted value. Specify an analog input terminal number.

Applicable SmartAXIS

FT1A-12	FT1A-24	FT1A-40	FT1A-48	FT1A Touch
X	X	X	X	X

Parameters

Parameter		Function	Range	Description
Number	AI	Analog input number	AI0 to AI37 *1	Unique number to identify the analog input FB. Specify an analog input terminal number. However, the analog input numbers already used in any other analog input FBs cannot be used.
	Input	-	-	-
Output	AOUT	Analog output	-	The analog input FB linearly converts the value (0 to 1000) of the specified analog input terminal and outputs the converted value in the range between the linear conversion minimum and maximum values. The analog input value before the linear conversion is stored in the special data register.*1
	Parameters	MIN	-32768 to 32767 *2	Specifies the minimum value in the range between -32768 and 32767 for the linear conversion. Set this parameter to a value that is smaller than the linear conversion maximum value.
		MAX	-32768 to 32767 *2	Specifies the maximum value in the range between -32768 and 32767 for the linear conversion. Set this parameter to a value that is larger than the linear conversion minimum value.

*1 The range for the analog input terminal number varies depending on the SmartAXIS type. The special data registers are assigned to the analog input terminals individually.

*2 When using the analog input cartridge (AI2 to AI5) of the Touch (transistor output type), the analog input FB linear conversion function cannot be used. Configure the linear conversion in the function area settings. For configuring the function area settings, see Chapter 3 "4.15 Analog Cartridge" in the "SmartAXIS Touch User's Manual".

Product series	Analog input terminal	Special data register
12-I/O type	AI0 to AI1 (2 inputs)	D8040 to D8041
24-I/O type	AI0 to AI3 (4 inputs)	D8040 to D8043
	AI10 to AI17 (8 inputs)	D8149 to D8156
	AI20 to AI27 (8 inputs)	D8158 to D8165
	AI30 to AI37 (8 inputs)	D8167 to D8174
40-I/O type	AI0 to AI5 (6 inputs)	D8040 to D8045
	AI10 to AI17 (8 inputs)	D8149 to D8156
	AI20 to AI27 (8 inputs)	D8158 to D8165
	AI30 to AI37 (8 inputs)	D8167 to D8174
48-I/O type	AI0 to AI7 (8 inputs)	D8040 to D8047
	AI10 to AI17 (8 inputs)	D8149 to D8156
	AI20 to AI27 (8 inputs)	D8158 to D8165
	AI30 to AI37 (8 inputs)	D8167 to D8174

Product series	Analog input terminal	Special data register
Touch (Relay output type)	AI0 to AI1 (2 inputs)	D8040 to D8041
	AI10 to AI17 (8 inputs)	D8149 to D8156
	AI20 to AI27 (8 inputs)	D8158 to D8165
	AI30 to AI37 (8 inputs)	D8167 to D8174
Touch (Transistor output type)	AI0 to AI1 (2 inputs)	D8040 to D8041
	AI2 to AI3 (2 inputs)	D8176 to D8177
	AI4 to AI5 (2 inputs)	D8186 to D8187
	AI10 to AI17 (8 inputs)	D8149 to D8156
	AI20 to AI27 (8 inputs)	D8158 to D8165
	AI30 to AI37 (8 inputs)	D8167 to D8174

Operation Example of the linear conversion

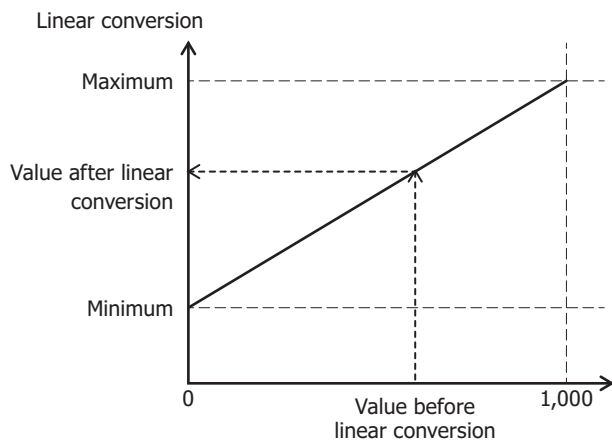

Example: When the minimum is -5,000 and the maximum is 10,000, an analog input value of 600 is linearly converted into 4,000.

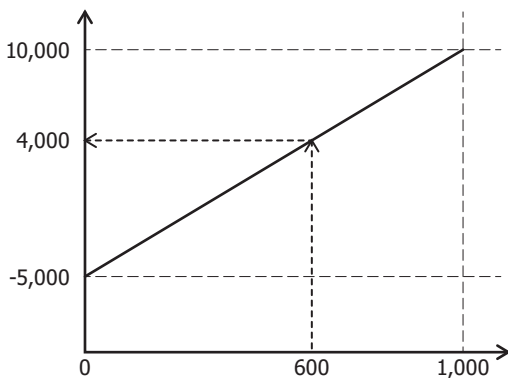

6: THE OUTPUT FB

This chapter describes the output FB of the SmartAXIS series.

Q (Digital Output)

Outputs the state (on/off) input to the FB to the specified external output.

Symbol



Operation

The digital output FB outputs the on/off state of the input (IN) to the specified external output. Specify an external output number as the output number.

Note: The output state of the digital output FB is off at the first scan.

Applicable SmartAXIS

FT1A-12	FT1A-24	FT1A-40	FT1A-48	FT1A Touch
X	X	X	X	X

Parameters

Parameter		Function	Range	Description
Number	Q	Digital output number	Q0 to Q141*1	Unique number to identify the digital output function block. Specify an external output number. However, the digital output numbers already used in any other digital output FBs cannot be used.
Input	IN	Input	On/off	Any function block having digital output (on/off) can be connected to the input. The on/off state of the input (IN) is output to the external output.
Output	OUT	Output	–	Outputs the on/off state of the input (IN) at the previous scan.
Parameters	–	–	–	–

*1 The range for the output number varies depending on the SmartAXIS type.

Type	Digital Output (Q)
12-I/O type	Q0 to Q3 (4 outputs)
24-I/O type	Q0 to Q7 (8 outputs), Q40 to Q61 (18 outputs), Q80 to Q101 (18 outputs), Q120 to Q141 (18 outputs)
40-I/O type	Q0 to Q17 (16 outputs), Q40 to Q61 (18 outputs), Q80 to Q101 (18 outputs), Q120 to Q141 (18 outputs)
48-I/O type	Q0 to Q21 (18 outputs), Q40 to Q61 (18 outputs), Q80 to Q101 (18 outputs), Q120 to Q141 (18 outputs)
Touch	Q0 to Q3 (4 outputs)

M (Internal Relay)

Outputs the input state (on/off) to the specified internal relay.

Symbol

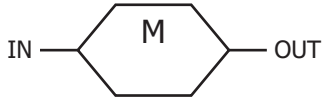

Operation

The internal relay FB outputs the on/off state of the input (IN) at the previous scan from the output (OUT). Specify an internal relay number.

Notes:

- The output state of internal relay FB can be maintained when the SmartAXIS starts the operation using the keep designation. For details on the keep designation, see the following chapter.
 - Chapter 5 "Special Functions" - "Keep and clear devices" in the SmartAXIS Pro/Lite User's Manual
 - Chapter 3 "Projects" - "4 Special Functions" - "Keep and Clear Control Devices" in the SmartAXIS Touch User's Manual
- When a FB is connected to the input connector of the internal relay FB and the on/off state of the internal relay is changed with the button operations on the SmartAXIS or WindLDR monitor dialog box, the changed state is immediately overwritten with the output state of the connected FB.

Applicable SmartAXIS

FT1A-12	FT1A-24	FT1A-40	FT1A-48	FT1A Touch
X	X	X	X	X

Parameters

Parameter		Function	Range	Description
Number	M	Internal relay number	M0 to M1277*1	Unique number to identify the internal relay FB. The internal relay number is automatically assigned in ascending order from zero. The internal relay number can be changed to a desired number. However, the internal relay numbers already used in any other internal relay FBs cannot be used.
Input	IN	Input	On/off	Any function block having digital output (on/off) can be connected to the input.
Output	OUT	Output	–	Outputs the on/off state of the input (IN) at the previous scan.
Parameters	–	–	–	–

*1 M0 to M317 for the 12-I/O type.

7: THE LOGICAL OPERATION FB

The logical operation function blocks perform logical operations on the input signals and output the result.

AND (Logical AND)

Calculates the logical AND on the input signals and outputs the result.

Symbol

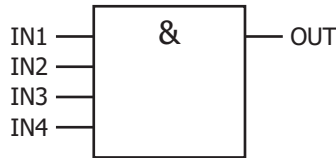

Operation

The AND FB calculates the logical AND on a maximum of four input signals (ON/OFF) and outputs the result.

Applicable SmartAXIS

FT1A-12	FT1A-24	FT1A-40	FT1A-48	FT1A Touch
X	X	X	X	X

Parameters

Parameter		Function	Range	Description
Number	B	Block number	B0 to B999 *1	Unique number to identify each function block. The block number is automatically assigned in ascending order from zero. The block number can be changed to a desired number. However, the block numbers already used in any other FBs cannot be used.
	IN1	On/off	–	Any function block having digital output (on/off) can be connected to each input. Unconnected inputs are handled as ON. However, all inputs cannot be unconnected.
Input	IN2	On/off	–	
	IN3	On/off	–	
	IN4	On/off	–	
Output	OUT	Output	–	Outputs the result of logical AND on IN1 through IN4.*2
Parameters	–	–	–	–

*1 B0 to B199 for the 12-I/O type.

*2 The result of logical AND on the on/off states of the inputs IN1 through IN4 is shown below.

IN1	IN2	IN3	IN4	OUT
0	0	0	0	0
0	0	0	1	0
0	0	1	0	0
0	0	1	1	0
0	1	0	0	0
0	1	0	1	0
0	1	1	0	0
0	1	1	1	0
1	0	0	0	0
1	0	0	1	0
1	0	1	0	0
1	0	1	1	0
1	1	0	0	0
1	1	0	1	0
1	1	1	0	0
1	1	1	1	1

NAND (Negative Logical AND)

Calculates the negative logical AND on the input signals and outputs the result.

Symbol

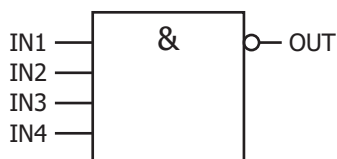

Operation

The NAND FB calculates the negative logical AND on a maximum of four input signals (ON/OFF) and outputs the result.

Applicable SmartAXIS

FT1A-12	FT1A-24	FT1A-40	FT1A-48	FT1A Touch
X	X	X	X	X

Parameters

Parameter	Function	Range	Description
Number	B	Block number	B0 to B999 *1
			Unique number to identify each function block. The block number is automatically assigned in ascending order from zero. The block number can be changed to a desired number. However, the block numbers already used in any other FBs cannot be used.
Input	IN1	On/off	-
	IN2	On/off	
	IN3	On/off	
	IN4	On/off	
			Any function block having digital output (on/off) can be connected to each input. Unconnected inputs are handled as ON. However, all inputs cannot be unconnected.
Output	OUT	Output	-
			Outputs the result of negative logical AND on IN1 through IN4.*2
Parameters	-	-	-

*1 B0 to B199 for the 12-I/O type.

*2 The result of negative logical AND on the on/off states of the inputs IN1 through IN4 is shown below.

IN1	IN2	IN3	IN4	OUT
0	0	0	0	1
0	0	0	1	1
0	0	1	0	1
0	0	1	1	1
0	1	0	0	1
0	1	0	1	1
0	1	1	0	1
0	1	1	1	1
1	0	0	0	1
1	0	0	1	1
1	0	1	0	1
1	0	1	1	1
1	1	0	0	1
1	1	0	1	1
1	1	1	0	1
1	1	1	1	0

OR (Logical OR)

Calculates the logical OR on the input signals and outputs the result.

Symbol

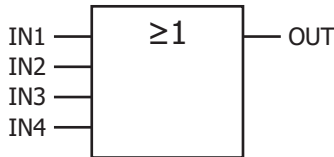

Operation

The OR FB calculates the logical OR on a maximum of four input signals (ON/OFF) and outputs the result.

Applicable SmartAXIS

FT1A-12	FT1A-24	FT1A-40	FT1A-48	FT1A Touch
X	X	X	X	X

Parameters

Parameter		Function	Range	Description
Number	B	Block number	B0 to B999 *1	Unique number to identify each function block. The block number is automatically assigned in ascending order from zero. The block number can be changed to a desired number. However, the block numbers already used in any other FBs cannot be used.
	IN1	On/off	–	Any function block having digital output (on/off) can be connected to each input. Unconnected inputs are handled as OFF. However, all inputs cannot be unconnected.
Input	IN2	On/off	–	
	IN3	On/off	–	
	IN4	On/off	–	
Output	OUT	Output	–	Outputs the result of logical OR on IN1 through IN4.*2
Parameters	–	–	–	–

*1 B0 to B199 for the 12-I/O type.

*2 The result of logical OR on the on/off states the inputs IN1 through IN4 is shown below.

IN1	IN2	IN3	IN4	OUT
0	0	0	0	0
0	0	0	1	1
0	0	1	0	1
0	0	1	1	1
0	1	0	0	1
0	1	0	1	1
0	1	1	0	1
0	1	1	1	1
1	0	0	0	1
1	0	0	1	1
1	0	1	0	1
1	0	1	1	1
1	1	0	0	1
1	1	0	1	1
1	1	1	0	1
1	1	1	1	1

NOR (Negative Logical OR)

Calculates the negative logical OR on the input signals and outputs the result.

Symbol

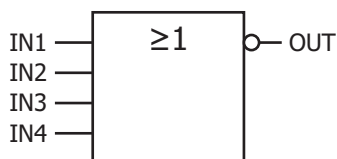

Operation

The NOR FB calculates the negative logical OR on a maximum of four input signals (ON/OFF) and outputs the result.

Applicable SmartAXIS

FT1A-12	FT1A-24	FT1A-40	FT1A-48	FT1A Touch
X	X	X	X	X

Parameters

Parameter	Function	Range	Description
Number	B	Block number	B0 to B999 *1
			Unique number to identify each function block. The block number is automatically assigned in ascending order from zero. The block number can be changed to a desired number. However, the block numbers already used in any other FBs cannot be used.
Input	IN1	On/off	-
	IN2	On/off	
	IN3	On/off	
	IN4	On/off	
			Any function block having digital output (on/off) can be connected to each input. Unconnected inputs are handled as OFF. However, all inputs cannot be unconnected.
Output	OUT	Output	-
			Outputs the result of negative logical OR on IN1 through IN4.*2
Parameters	-	-	-

*1 B0 to B199 for the 12-I/O type.

*2 The result of negative logical OR on the on/off states of the inputs IN1 through IN4 is shown below.

IN1	IN2	IN3	IN4	OUT
0	0	0	0	1
0	0	0	1	0
0	0	1	0	0
0	0	1	1	0
0	1	0	0	0
0	1	0	1	0
0	1	1	0	0
0	1	1	1	0
1	0	0	0	0
1	0	0	1	0
1	0	1	0	0
1	0	1	1	0
1	1	0	0	0
1	1	0	1	0
1	1	1	0	0
1	1	1	1	0

XOR (Exclusive Logical OR)

Calculates the exclusive logical OR on the input signals and outputs the result.

Symbol

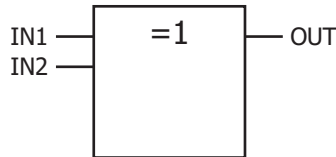

Operation

The XOR FB calculates the exclusive logical OR on a maximum of two input signals (ON/OFF) and outputs the result.

Applicable SmartAXIS

FT1A-12	FT1A-24	FT1A-40	FT1A-48	FT1A Touch
X	X	X	X	X

Parameters

Parameter		Function	Range	Description
Number	B	Block number	B0 to B999 *1	Unique number to identify each function block. The block number is automatically assigned in ascending order from zero. The block number can be changed to a desired number. However, the block numbers already used in any other FBs cannot be used.
	IN1	On/off	–	Any function block having digital output (on/off) can be connected to each input. Unconnected inputs are handled as OFF. However, all inputs cannot be unconnected.
IN2	On/off	–		
Output	OUT	Output	–	Outputs the result of exclusive logical OR on IN1 through IN2.*2
Parameters	–	–	–	–

*1 B0 to B199 for the 12-I/O type.

*2 The result of exclusive logical OR on the on/off states of the inputs IN1 through IN2 is shown below.

IN1	IN2	OUT
0	0	0
0	1	1
1	0	1
1	1	0

XNOR (Negative Exclusive Logical OR)

Calculates the negative exclusive logical OR on the input signals and outputs the result.

Symbol

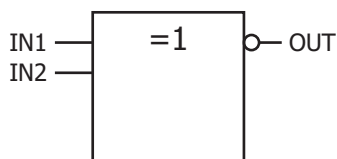

Operation

The XNOR FB calculates the negative exclusive logical OR on a maximum of two input signals (ON/OFF) and outputs the result.

Applicable SmartAXIS

FT1A-12	FT1A-24	FT1A-40	FT1A-48	FT1A Touch
X	X	X	X	X

Parameters

Parameter	Function	Range	Description
Number	B	Block number	B0 to B999 *1
Input	IN1	On/off	Unique number to identify each function block. The block number is automatically assigned in ascending order from zero. The block number can be changed to a desired number. However, the block numbers already used in any other FBs cannot be used.
	IN2	On/off	
Output	OUT	Output	Any function block having digital output (on/off) can be connected to each input. Unconnected inputs are handled as OFF. However, all inputs cannot be unconnected.
Parameters	–	–	Outputs the result of negative exclusive logical OR on IN1 through IN2.*2

*1 B0 to B199 for the 12-I/O type.

*2 The result of negative exclusive logical OR on the on/off states of the inputs IN1 through IN2 is shown below.

IN1	IN2	OUT
0	0	1
0	1	0
1	0	0
1	1	1

NOT (Negation)

Calculates the negation of the input signal and outputs the result.

Symbol

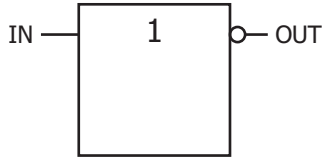

Operation

The NOT FB outputs the result of negating the input signal (ON/OFF).

Applicable SmartAXIS

FT1A-12	FT1A-24	FT1A-40	FT1A-48	FT1A Touch
X	X	X	X	X

Parameters

Parameter		Function	Range	Description
Number	B	Block number	B0 to B999 *1	Unique number to identify each function block. The block number is automatically assigned in ascending order from zero. The block number can be changed to a desired number. However, the block numbers already used in any other FBs cannot be used.
Input	IN	On/off	–	Any function block having digital output (on/off) can be connected.
Output	OUT	On/off	–	Outputs the result of negating the input (IN). *2
Parameters	–	–	–	–

*1 B0 to B199 for the 12-I/O type.

*2 The result of negating input IN is shown below.

IN	OUT
0	1
1	0

SOTU (Shot Up)

Turns on the output for one scan when the input signal changes from off to on.

Symbol

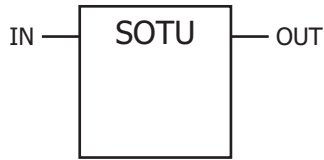

Operation

The SOTU FB turns on the output for one scan when the input signal changes from OFF to ON.

Applicable SmartAXIS

FT1A-12	FT1A-24	FT1A-40	FT1A-48	FT1A Touch
X	X	X	X	X

Parameters

Parameter	Function	Range	Description	
Number	B	Block number	B0 to B999 *1	Unique number to identify each function block. The block number is automatically assigned in ascending order from zero. The block number can be changed to a desired number. However, the block numbers already used in any other FBs cannot be used.
Input	IN	On/off	-	Any function block having digital output (on/off) can be connected.
Output	OUT	On/off	-	The output turns on for an interval of one scan when the input (IN) changes from OFF to ON. *2
Parameters	-	-	-	-

*1 B0 to B199 for the 12-I/O type.

*2 The timing chart of the SOTU is shown below.

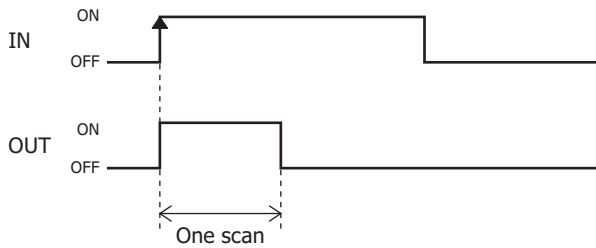

SOTD (Shot Down)

Turns on the output for one scan when the input signal changes from on to off.

Symbol

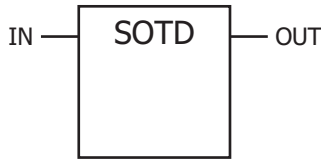

Operation

The SOTD FB turns on the output for one scan when the input signal changes from ON to OFF.

Applicable SmartAXIS

FT1A-12	FT1A-24	FT1A-40	FT1A-48	FT1A Touch
X	X	X	X	X

Parameters

Parameter	Function	Range	Description
Number	B	Block number	B0 to B999 *1
Input	IN	On/off	–
Output	OUT	On/off	–
Parameters	–	–	–

*1 B0 to B199 for the 12-I/O type.

*2 The timing chart of the SOTD is shown below.

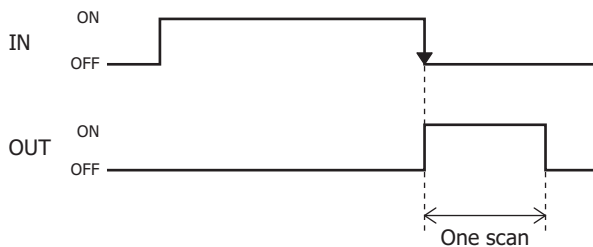

TRUTH (Truth Table)

Processes the input signals according to the configured truth table and outputs the result.

Symbol

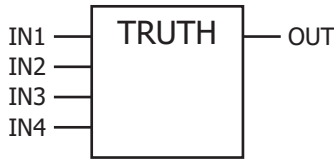

Operation

The TRUTH FB turns on the output according to the truth table configured for the bit patterns of a maximum of four input signals (ON/OFF) and outputs the result.

Truth table

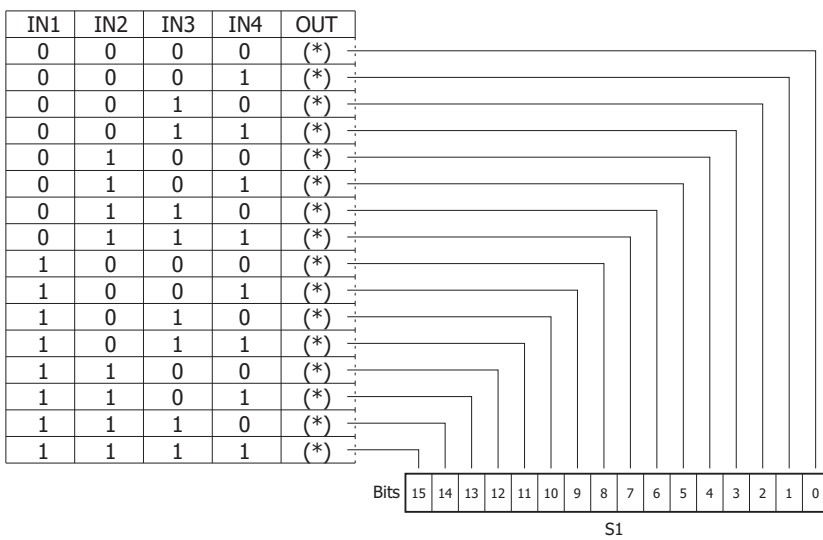

Applicable SmartAXIS

FT1A-12	FT1A-24	FT1A-40	FT1A-48	FT1A Touch
X	X	X	X	X

Parameters

Parameter	Function	Range	Description
Number	B	Block number	B0 to B999 *1
Input	IN1	On/off	Any function block having digital output (on/off) can be connected to each input. Unconnected inputs are handled as OFF. However, all inputs cannot be unconnected.
	IN2	On/off	
	IN3	On/off	
	IN4	On/off	
Output	OUT	Output	Outputs the result according to the configured truth table.
Parameters	S1	Truth table	On/off
			Outputs (on/off) can be configured for all 16 bit patterns of the IN1 through IN4.

*1 B0 to B199 for the 12-I/O type.

Valid Devices

Parameter	Function	I	Q	M	R	T	TC	TP	C	CC	CP	B	D	AI	Constant
S1	Truth table	-	-	-	-	-	-	-	-	-	-	-	-	-	X

8: THE TIMER FB

The timer FBs are used in a variety of ways, such as to delay the change of an output state for a specified time interval or to output pulses in accordance with configured values.

TIMU (On-delay Count Up Timer)

When the execution input turns on, counting starts, and the current value is incremented. When the elapsed time reaches the specified on-delay time, the output turns on.

Symbol

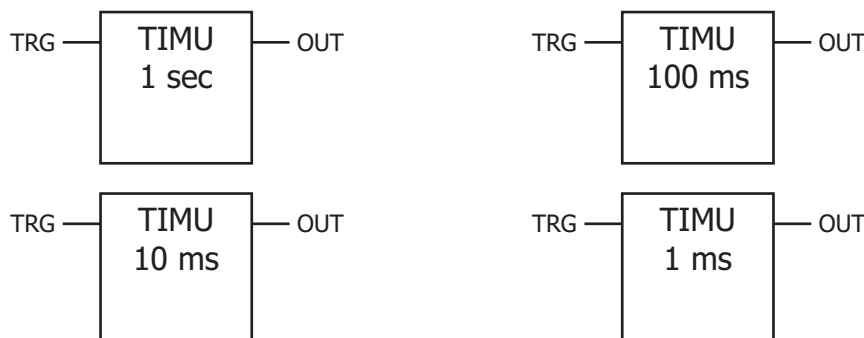

Operation

When the execution input (TRG) is off, the current value is 0 and the output (OUT) is off.

When the execution input turns on, the current value starts being incremented.

While the execution input is on, the current value is incremented, and when it reaches the preset value (TP), the counting stops and the output turns on.

After the counting stops, the current value is held and the output keeps on until the execution input turns off.

Applicable SmartAXIS

FT1A-12	FT1A-24	FT1A-40	FT1A-48	FT1A Touch
X	X	X	X	X

Parameters

Parameter	Function	Range	Description
Number	T	Timer number	Unique number to identify the Timer function block. The timer number is automatically assigned in ascending order from zero. The timer number can be changed to a desired number. However, the timer numbers already used in any other timer FBs cannot be used.
Input	TRG	Execution input	On/off
Output	OUT	Output	–
Parameters	TP	Preset value	0 to 65,535
	TU	Time unit	1 sec/100 ms/ 10 ms/1 ms

*1 T0 to T99 for the 12-I/O type.

*2 The preset value can be 0 to 65,535 and specified using a constant or a data register. To indirectly specify the preset value with a data register, specify the data register number where the preset value is stored.

Valid Devices

Parameter	Function	I	Q	M	R	T	TC	TP	C	CC	CP	B	D	AI	Constant
TRG	Execution input	X	X	X	X	X	–	–	X	–	–	X	–	–	–
TP	Preset value	–	–	–	–	–	–	–	–	–	–	–	X	–	X

Timing Chart

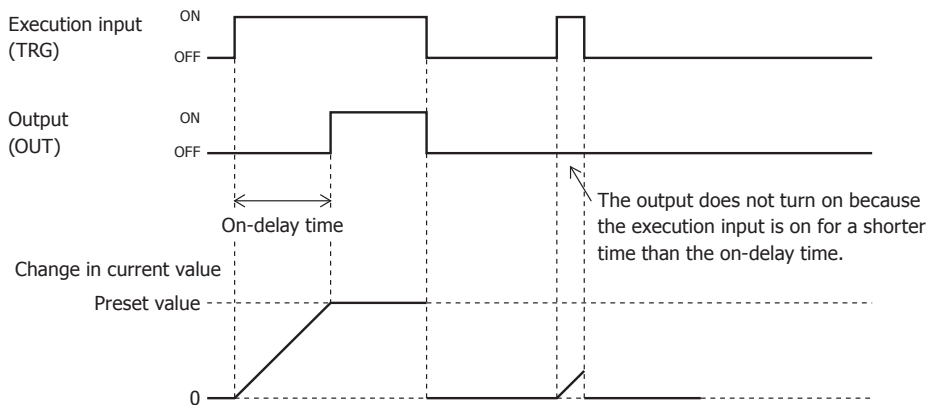

When the execution input (TRG) is off, the current value is 0 and the output (OUT) is off.

When the execution input turns on, counting starts. While the execution input is on, the current value is incremented, and when it reaches the preset value (TP), the counting stops and the output turns on. The output keeps on until the execution input turns off.

Notes:

- T0 to T199 can be used for the timer number. However, for the 12-I/O type, T0 to T99 can be used.
- The preset value can be 0 to 65,535 and specified using a constant or a data register.
To indirectly specify the preset value with a data register, specify the data register number where the preset value is stored.

FB	TIMU 1 sec	TIMU 100 ms	TIMU 10 ms	TIMU 1 ms
The range of Preset value	0 to 65535 seconds	0 to 6553.5 seconds	0 to 655.35 seconds	0 to 65.535 seconds

- The time numbers (T) already used in any other timer FBs cannot be used.
- If the preset value for the on-delay count up timer is changed during counting, the timer operates as follows.
 - (1) If the changed preset value is larger than the current value, counting continues until the current value reaches the changed preset value.
 - (2) If the changed preset value is less than or equal to the current value, the counting stops and the output turns on immediately.
- The preset values can be changed by external devices, such as operator interfaces, WindLDR, and LCD and buttons on the SmartAXIS Pro/Touch. The changed preset values are stored in the RAM, and the changes are not reflected to the user program saved in the ROM. When the SmartAXIS is turned off, the changed preset values are reset to the original values stored in the ROM.
- To store the changed preset values to the user program in ROM, use one of the following methods.

Store the preset values to the user program in the ROM using WindLDR (SmartAXIS Pro/Lite only).

Select **Online > Monitor > Start Monitor**. Select **Online > PLC > Status** to open the PLC Status dialog box, and click the **Confirm** button under Timer/counter preset value change state. Once the changed preset values are confirmed, the preset values cannot be changed back to its original values, even if you click the **Cancel** button.

Store the preset values to the user program in the ROM with button operations on the SmartAXIS.

For operations on the SmartAXIS Pro, see Chapter 6 "HMI Function" in the "SmartAXIS Pro/Lite User's Manual". For operations on the SmartAXIS Touch, see the "SmartAXIS Touch User's Manual".

Timer Accuracy

- Since the timer has an advance error which length is same as the specified time unit, that error may cause a problem depending on the system. Use a time unit that is as small as possible.
For example, when creating a 1 sec timer, if the timer consists of TIMU 1 sec (time unit 1 sec) and the preset value is "1", it may immediately stop without 1 second of on-delay time after it is started due to the advance error. In this situation, the advance error can be reduced to within 1 ms by the use of TIMU 1 ms (time unit 1 ms) with the preset value of "1000", which makes an even more accurate 1 sec timer.
- Timer accuracy due to software configuration depends on three factors: timer input errors, timer counting errors, and timeout output errors. These errors are not constant, but vary with the user program and other causes.

■ Timer input error

The Actual timer input state is read at the END processing and stored to the input memory. For this reason, an error occurs depending on the timing when the actual timer input turns on in a scan cycle. The same error occurs on the normal input and the catch input.

Error	Definition
Tie	The time from the external input turns on to the END processing
Tet	The time from the END processing to the timer FB execution

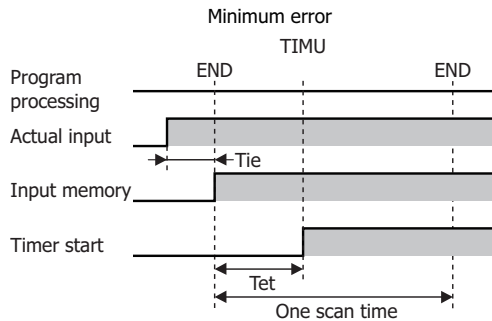

When the actual input turns on immediately before the END processing, $Tie \approx 0$. In this case, the timer input error is only Tet (behind error), and is at its minimum.

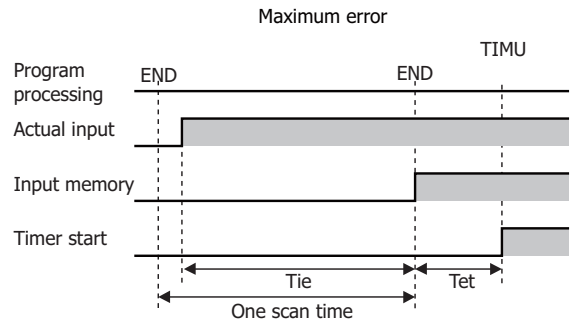

When the actual input turns on immediately after the END processing, $Tie \approx \text{one scan time}$. In this case, the timer input error is: $Tie + Tet \approx 1 \text{ scan time} + Tet$ (behind error), and is at its maximum.

■ Timer counting error

Every timer FBs operation is based on individual asynchronous 16-bit reference timers. Therefore, an error occurs depending on the status of the asynchronous 16-bit timer when the timer FB is executed.

		TIMU 1 sec (1 sec timer)	TIMU 100 ms (100 ms timer)	TIMU 10 ms (10 ms timer)	TIMU 1 ms (1 ms timer)
Max	Advance error	1000 ms	100 ms	10 ms	1 ms
	Behind error	One scan time	One scan time	One scan time	One scan time

■ Timeout output error

The output memory status is set to the actual output at the End processing. So, an error occurs depending on the timing when the timer FB is executed in the user program in case the timeout output turns on.

Error	Definition
Tte	The time from the timer FB execution to the END processing

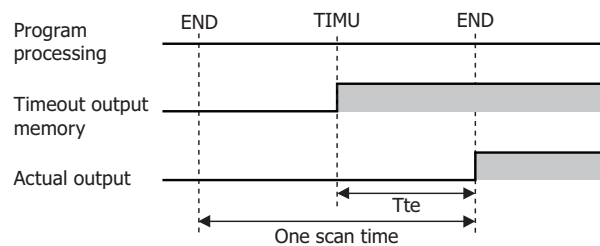

Timeout output error is equal to the Tte (behind error) and can be between 0 and one scan time.
 $0 < Tte < 1 \text{ scan time}$

8: THE TIMER FB

■ Error list

		Timer input error	Timer counting error	Time-up output error	Overall error calculation formula
Min	Advance error	0 *1	0	0 *1	0
	Behind error	Tet (Tie ≈ 0)	0	Tte	0 (Tet + Tie + Tte ≈ Advance error)
Max	Advance error	0 *1	Time unit	0 *1	Time unit - (Tte + Tet)
	Behind error	1 s.t. + Tet (1 s.t.)	1 s.t.	Tte (1 s.t.)	2 s.t. + (Tte + Tet)

*1 Advance error does not occur at the timer input and timeout output.

s.t. : Scan time, Tet + Tte = 1 s.t.

Time unit : Timer FB clock increment (1 ms /10 ms /100 ms /1 sec)

The maximum advance error: Time unit - 1 s.t.

The maximum lag error: 3 s.t.

The timer input error and timeout output error shown above do not include the input response time (behind error) and output response time (behind error) caused by hardware.

Power Failure Memory Protection

The Timer FBs do not have power failure protection.

A timer (1-sec timer, 100-ms timer, 10-ms timer) with this protection can be devised using a counter FB and special internal relay M8121 (1-sec clock), M8122 (100-ms clock), or M8123 (10-ms clock).

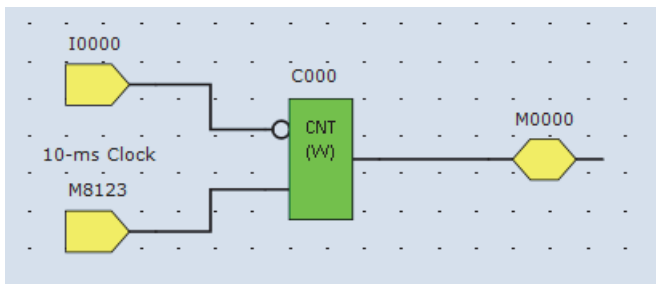

In this case, specify the adding counter (CNT FB) C2 to keep the current value. For details on retaining the current value, see Chapter 5 "Special Functions" – "Keep Designation" in the SmartAXIS Pro/Lite User's Manual.

TIMD (On-delay Count Down Timer)

When the execution input turns on, the counting starts, and the current value is decremented. When the elapsed time reaches the specified on-delay time, the output turns on.

Symbol

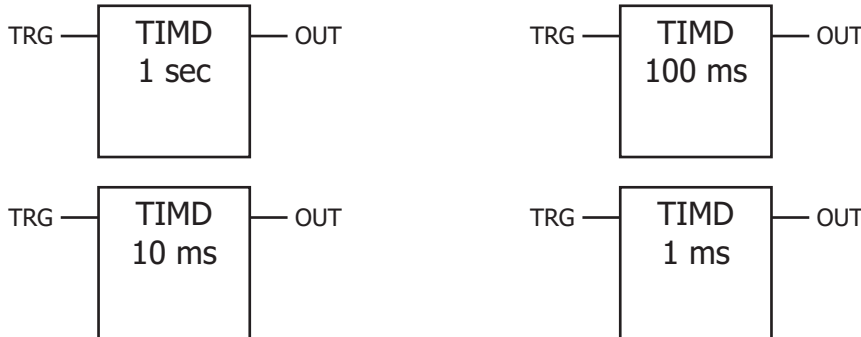

Operation

When the execution input (TRG) turns on, the current value starts being decremented.

While the execution input is on, the current value is decremented. When the current value reaches 0, the counting stops and the output (OUT) turns on.

After the counting stops, the current value remains at 0 and output keeps on until the execution input turns off.

When the execution input is off, the current value returns to the preset value and the output is off.

Applicable SmartAXIS

FT1A-12	FT1A-24	FT1A-40	FT1A-48	FT1A Touch
X	X	X	X	X

Parameters

Parameter	Function	Range	Description
Number	T	Timer number	Unique number to identify the Timer function block. The timer number is automatically assigned in ascending order from zero. The timer number can be changed to a desired number. However, the timer numbers already used in any other Timer FBs cannot be used.
Input	TRG	Execution input	When the execution input turns on, counting starts. While the execution input is on, the current value is decremented until it reaches 0. When the execution input is off, the current value returns to the preset value.
Output	OUT	Output	When the current value is greater than 0, the output is off. When the current value is 0, the output is on.
Parameters	TP	Preset value	Specify the time interval (on-delay time) from when the execution input turns on to when the output turns on. The value can be specified using a constant or a data register.*2
	TU	Time unit	Specify the time unit for the timer.

*1 T0 to T99 for the 12-I/O type.

*2 The preset value can be 0 to 65,535 and specified using a constant or a data register.

To indirectly specify the preset value with a data register, specify the data register number where the preset value is stored.

Valid Devices

Parameter	Function	I	Q	M	R	T	TC	TP	C	CC	CP	B	D	AI	Constant
TRG	Execution input	X	X	X	X	X	-	-	X	-	-	X	-	-	-
TP	Preset value	-	-	-	-	-	-	-	-	-	-	-	X	-	X

Timing Chart

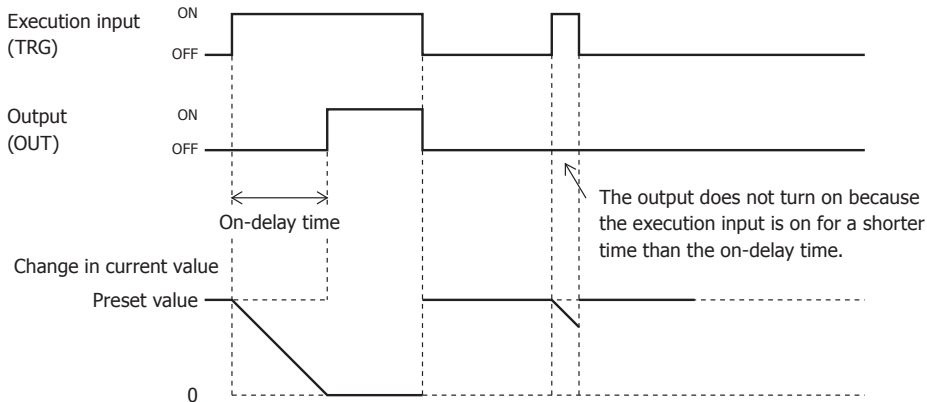

When the execution input (TRG) is off, the current value returns to the preset value (TP) and the output (OUT) is off. When the execution input turns on, counting starts. While the execution input is on, the current value is decremented, and when it reaches 0, the counting stops and the output turns on. The output keeps on until the execution input turns off.

Notes:

- T0 to T199 can be used for the timer number. However, for the 12-I/O type, T0 to T99 can be used.
- The preset value can be 0 to 65,535 and specified using a constant or a data register. To indirectly specify the preset value with a data register, specify the data register number where the preset value is stored.

FB	TIMD 1 sec	TIMD 100 ms	TIMD 10 ms	TIMD 1 ms
The range of Preset value	0 to 65535 seconds	0 to 6553.5 seconds	0 to 655.35 seconds	0 to 65.535 seconds

- The time numbers (T) already used in any other timer FBs cannot be used.
- Even if the preset value for the on-delay count down timer is changed during counting, the timer continues to operate with the original preset value until the execution input turns off. When the execution input turns off, the new preset value is reflected in the current value. However, if the preset value is changed to 0, the counting stops and the timer output is turned on immediately.
- The preset values can be changed by external devices, such as operator interfaces, WindLDR, and LCD and buttons on the SmartAXIS Pro/Touch. The changed preset values are stored in the RAM, and the changes are not reflected to the user program saved in the ROM. When the SmartAXIS is turned off, the changed preset values are reset to the original values stored in the ROM.
- For details on how to store the changed preset value to the user program in the ROM, see "The timer FB" - "TIMU (On-delay Count Up Timer)" on page 8-1.
- Since the timer has advance error or behind error that error may cause a problem depending on the system. For details, see "The timer FB" - "TIMU (On-delay Count Up Timer)" - "Timer Accuracy" on page 8-3.

TIMOU (Off-delay Count Up Timer)

When the execution input turns off, counting starts, and the current value is incremented. When the elapsed time reaches the specified off-delay time, the output turns off.

Symbol

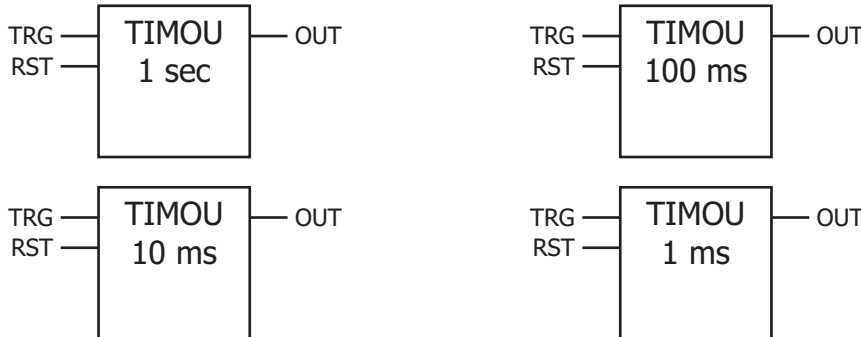

Operation

When the execution input (TRG) turns on while the reset input (RST) is off, the current value returns to 0 and the output (OUT) turns on.

While the execution input is on, the output is on.

When the execution input turns off, the current value starts being incremented. While the execution input is off, the current value is incremented, and when it reaches the preset value, the output turns off. The current value is held until the execution input turns on.

When the reset input turns on, the output immediately turns off, regardless of the on/off state of the execution input.

Applicable SmartAXIS

FT1A-12	FT1A-24	FT1A-40	FT1A-48	FT1A Touch
X	X	X	X	X

Parameters

Parameter	Function	Range	Description	
Number	T	Timer number	T0 to T199 *1	Unique number to identify the Timer function block. The timer number is automatically assigned in ascending order from zero. The timer number can be changed to a desired number. However, the timer numbers already used in any other Timer FBs cannot be used.
Input	TRG	Execution input	On/off	When the execution input turns on, the current value returns to 0 and the output turns on. While the execution input is on, the output is on. When the execution input turns off, the current value starts being incremented. While the execution input is off, the current value is incremented until it reaches the preset value.
	RST	Reset input	On/off	The reset input has priority over the execution input. When the reset input is on, the output is off, regardless of the on/off state of the execution input. When unconnected, the reset input is handled as off.
Output	OUT	Output	-	Even after the execution input turns off, while the current value is incremented, the output keeps on. The output turns off when the current value is greater than or equal to the preset value.
Parameters	TP	Preset value	0 to 65,535	Specify the time interval (off-delay time) from when the execution input turns off to when the output turns off. The preset value can be specified using a constant or a data register.*2
	TU	Time unit	1 sec/100 ms/ 10 ms/1 ms	Specify the time unit for the timer.

*1 T0 to T99 for the 12-I/O type.

*2 The preset value can be 0 to 65,535 and specified using a constant or a data register.

To indirectly specify the preset value with a data register, specify the data register number where the preset value is stored.

8: THE TIMER FB

Valid Devices

Parameter	Function	I	Q	M	R	T	TC	TP	C	CC	CP	B	D	AI	Constant
TRG	Execution input	X	X	X	X	X	-	-	X	-	-	X	-	-	-
RST	Reset input	X	X	X	X	X	-	-	X	-	-	X	-	-	-
TP	Preset value	-	-	-	-	-	-	-	-	-	-	-	X	-	X

Timing Chart

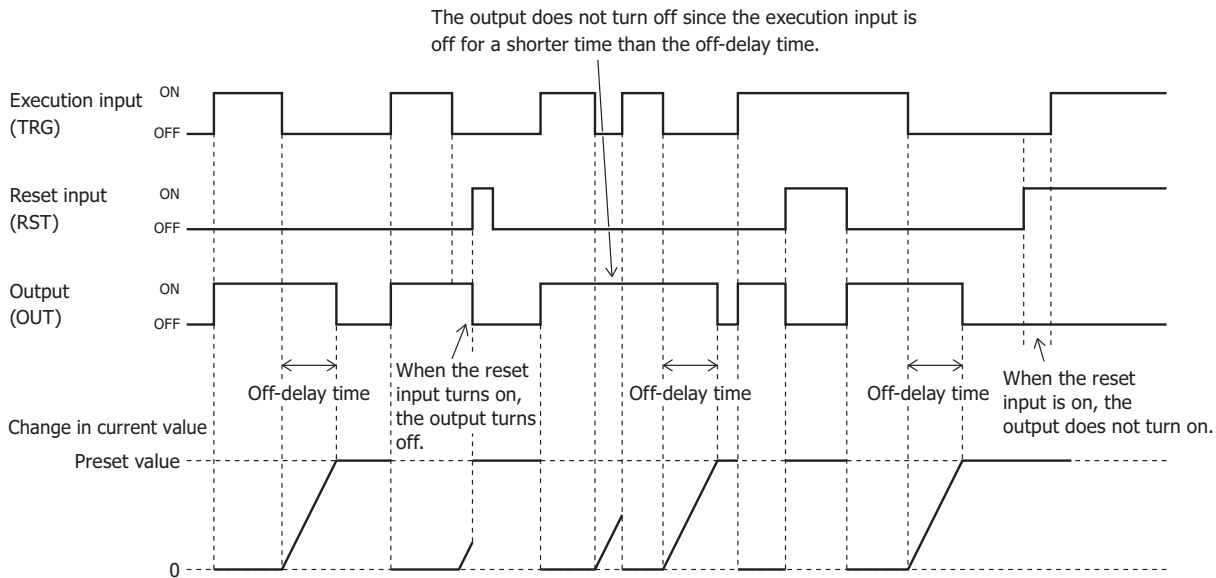

When the execution input (TRG) turns on while the reset input (RST) is off, the current value returns to 0 and the output (OUT) turns on.

While the execution input is on, the output is on. When the execution input turns off, the current value starts being incremented. Even after the execution input turns off, the output keeps on until the current value reaches the preset value (TP). When the current value reaches the preset value, the counting stops and the output turns off.

While the counting is proceeding, if the execution input turns on again, the current value returns to 0.

When the reset input is on, the output is off, regardless of the on/off state of the execution input.

Notes:

- T0 to T199 can be used for the timer number. However, for the 12-I/O type, T0 to T99 can be used.
- The preset value can be 0 to 65,535 and specified using a constant or a data register. To indirectly specify the preset value with a data register, specify the data register number where the preset value is stored.

FB	TIMOU 1 sec	TIMOU 100 ms	TIMOU 10 ms	TIMOU 1 ms
The range of Preset value	0 to 65535 seconds	0 to 6553.5 seconds	0 to 655.35 seconds	0 to 65.535 seconds

- The time numbers (T) already used in any other timer FBs cannot be used.
- If the preset value for the off-delay count up timer is changed during counting, the timer operates as follows.
 - (1) If the changed preset value is larger than the current value, counting continues until the current value reaches the changed preset value.
 - (2) If the changed preset value is less than or equal to the current value, the output immediately turns off.
- The preset values can be changed by external devices, such as operator interfaces, WindLDR, and LCD and buttons on the SmartAXIS Pro/Touch. The changed preset values are stored in the RAM, and the changes are not reflected to the user program saved in the ROM. When the SmartAXIS is turned off, the changed preset values are reset to the original values stored in the ROM.
- For details on how to store the changed preset value to the user program in the ROM, see "The timer FB" - "TIMU (On-delay Count Up Timer)" on page 8-1.
- Since the timer has advance error or behind error, that error may become a problem depending on the system. For details, see "The timer FB" - "TIMU (On-delay Count Up Timer)" - "Timer Accuracy" on page 8-3.

TIMOD (Off-delay Count Down Timer)

When the execution input turns off, counting starts, and the current value is decremented. When the elapsed time reaches the specified off-delay time, the output turns off.

Symbol

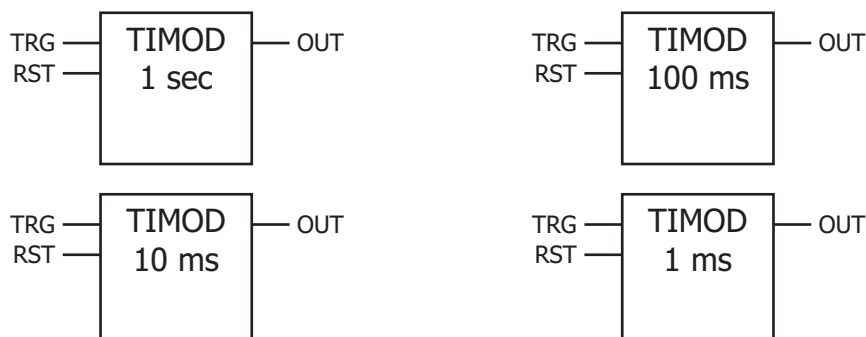

Operation

When the execution input (TRG) turns on while the reset input (RST) is off, the current value returns to preset value and the output (OUT) turns on.

While the execution input is on, the output is on.

When the execution input turns off, the current value starts being decremented. Even after the execution input turns off, the output keeps on until the current value reaches 0. When the current value reaches 0, the output turns off.

While the counting is proceeding, if the execution input turns on, the current value returns to the preset value.

When the reset input turns on, the output immediately turns off, regardless of the on/off state of the execution input.

Applicable SmartAXIS

FT1A-12	FT1A-24	FT1A-40	FT1A-48	FT1A Touch
X	X	X	X	X

Parameters

Parameter	Function	Range	Description
Number	T	Timer number	Unique number to identify the Timer function block. The timer number is automatically assigned in ascending order from zero. The timer number can be changed to a desired number. However, the timer numbers already used in any other Timer FBs cannot be used.
Input	TRG	Execution input	On/off When the execution input turns on, the current value returns to the preset value and the output turns on. While the execution input is on, the output is on. When the execution input turns off, the counting starts. While the execution input is off, the current value is decremented until it reaches 0.
	RST	Reset input	On/off The reset input has priority over the execution input. When the reset input is on, the output is off, regardless of the on/off state of the execution input. When unconnected, the reset input is handled as off.
Output	OUT	Output	– When the current value is larger than 0, the output is on. When the current value is 0, the output is off.
Parameters	TP	Preset value	0 to 65,535 Specify the time interval (off-delay time) from when the execution input turns off to when the output turns off. The preset value can be specified using a constant or a data register.*2
	TU	Time unit	1 sec/100 ms/ 10 ms/1 ms Specify the time unit for the timer.

*1 T0 to T99 for the 12-I/O type.

*2 The preset value can be 0 to 65,535 and specified using a constant or a data register.

To indirectly specify the preset value with a data register, specify the data register number where the preset value is stored.

8: THE TIMER FB

Valid Devices

Parameter	Function	I	Q	M	R	T	TC	TP	C	CC	CP	B	D	AI	Constant
TRG	Execution input	X	X	X	X	X	-	-	X	-	-	X	-	-	-
RST	Reset input	X	X	X	X	X	-	-	X	-	-	X	-	-	-
TP	Preset value	-	-	-	-	-	-	-	-	-	-	-	X	-	X

Timing Chart

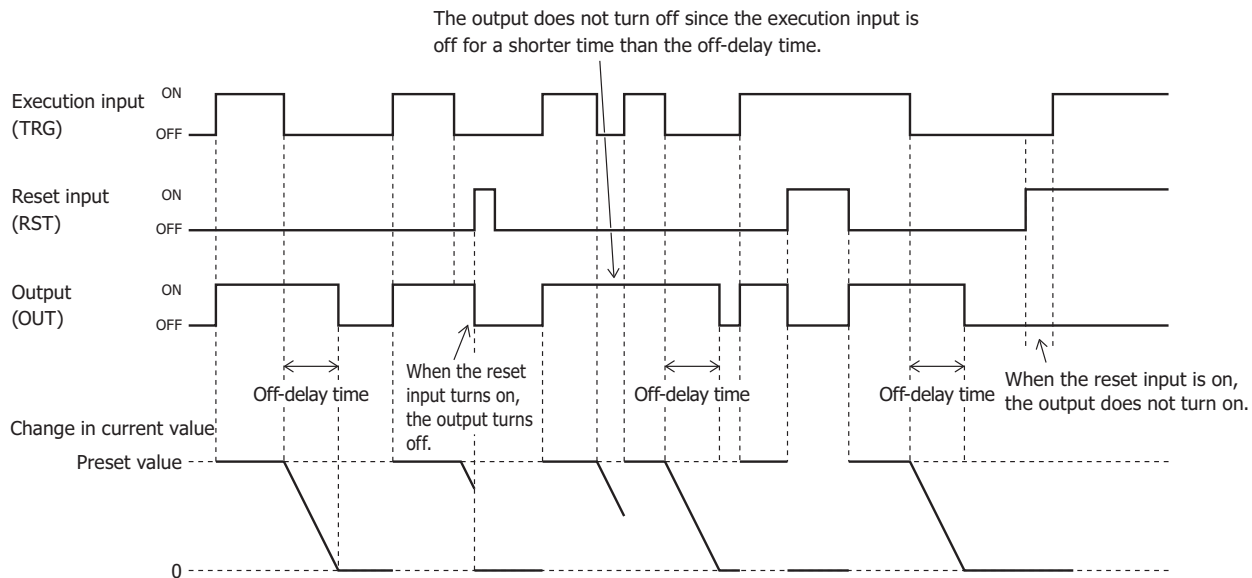

When the execution input (TRG) turns on while the reset input (RST) is off, the current value returns to preset value and the output (OUT) turns on.

While the execution input is on, the output is on. When the execution input turns off, the current value starts being decremented. Even after the execution input turns off, the output keeps on until the current value reaches 0. When the current value reaches 0, the output turns off. While the counting is proceeding, if the execution input turns on, the current value returns to the preset value.

When the reset input turns on, the current value becomes 0 and the output turns off immediately, regardless of the on/off state of the execution input.

Notes:

- T0 to T199 can be used for the timer number. However, for the 12-I/O type, T0 to T99 can be used.
- The preset value can be 0 to 65,535 and specified using a constant or a data register. To indirectly specify the preset value with a data register, specify the data register number where the preset value is stored.

FB	TIMOD 1 sec	TIMOD 100 ms	TIMOD 10 ms	TIMOD 1 ms
The range of Preset value	0 to 65535 seconds	0 to 6553.5 seconds	0 to 655.35 seconds	0 to 65.535 seconds

- The time numbers (T) already used in any other timer FBs cannot be used.
- Even if the preset value for the off-delay count down timer is changed during counting, the timer continues to operate with the original preset value until the execution input turns on. When the execution input turns on, the new preset value is reflected in the current value. However, if the preset value is changed to 0, the counting stops and the output immediately turns off.
- The preset values can be changed by external devices, such as operator interfaces, WindLDR, and LCD and buttons on the SmartAXIS Pro/Touch. The changed preset values are stored in the RAM, and the changes are not reflected to the user program saved in the ROM. When the SmartAXIS is turned off, the changed preset values are reset to the original values stored in the ROM.
- For details on how to store the changed preset value to the user program in the ROM, see "The timer FB" - "TIMU (On-delay Count Up Timer)" on page 8-1.
- Since the timer has advance error or behind error, that error may cause a problem depending on the system. For details, see "The timer FB" - "TIMU (On-delay Count Up Timer)" - "Timer Accuracy" on page 8-3.

TIMCU (On/off-delay Timer)

When the execution input turns on, counting starts. When the elapsed time reaches the specified on-delay time, the output turns on. When the execution input turns off, counting starts. When the elapsed time reaches the specified off-delay time, the output turns off. The on-delay and off-delay time counting is performed by count-up.

Symbol

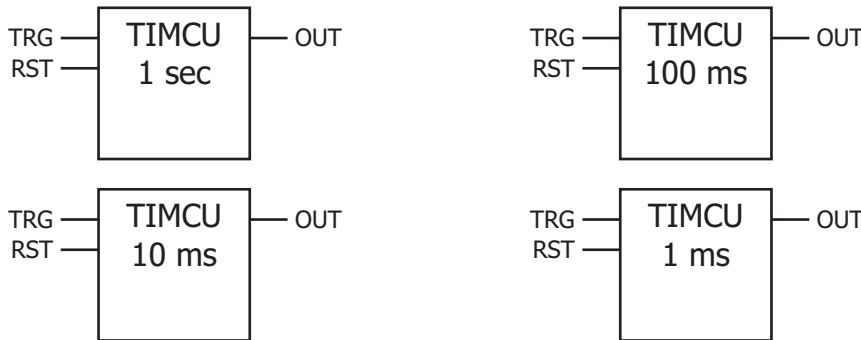

Operation

This FB combines the functions of the on-delay count up timer and the off-delay count up timer.

When the execution input (TRG) turns on while the reset input (RST) is off, the current value (on-delay elapsed time) starts being incremented. While the execution input is on, the current value (on-delay elapsed time) is incremented, and when it reaches the on-delay time (TP1), the output (OUT) turns on.

After that, when the execution input turns off, counting starts, and while the execution input is off, the current value (off-delay elapsed time) is incremented. When the current value (off-delay elapsed time) reaches the off-delay time (TP2), the output turns off.

When the reset input is on, the output is off, regardless of the on/off state of the execution input.

Applicable SmartAXIS

FT1A-12	FT1A-24	FT1A-40	FT1A-48	FT1A Touch
X	X	X	X	X

Parameters

Parameter		Function	Range	Description
Number	T	Timer number	T0 to T199 *1	Unique number to identify the Timer function block. The timer number is automatically assigned in ascending order from zero. The timer number can be changed to a desired number. However, the timer numbers already used in any other Timer FBs cannot be used.
	Input	TRG	Execution input	On/off
	RST	Reset input	On/off	The reset input has priority over the execution input. When the reset input is on, the output is off, regardless of the on/off state of the execution input. When unconnected, the reset input is handled as off.
Output	OUT	Output	-	The output turns on in the situations below. <ul style="list-style-type: none"> •When the current value equals the on-delay time (TP1). The output turns off in the situations below. <ul style="list-style-type: none"> •When the current value equals the off-delay time (TP2). •When the reset input is on.
Parameters	TP1	On-delay time	0 to 65,535	Specify the time interval (on-delay time) from when the execution input turns on to when the output turns on. The On-delay time value can be specified using a constant or a data register.*2
	TP2	Off-delay time	0 to 65,535	Specify the time interval (off-delay time) from when the execution input turns off to when the output turns off. The Off-delay time value can be specified using a constant or a data register.*2
	TU	Time unit	1 sec/100 ms/ 10 ms/1 ms	Specify the time unit for the timer. (Common in TP1 and TP2)

*1 T0 to T99 for the 12-I/O type.

*2 The preset value can be 0 to 65,535 and specified using a constant or a data register.

To indirectly specify the preset value with a data register, specify the data register number where the preset value is stored.

8: THE TIMER FB

Valid Devices

Parameter	Function	I	Q	M	R	T	TC	TP	C	CC	CP	B	D	AI	Constant
TRG	Execution input	X	X	X	X	X	-	-	X	-	-	X	-	-	-
RST	Reset input	X	X	X	X	X	-	-	X	-	-	X	-	-	-
TP1	On-delay time	-	-	-	-	-	-	-	-	-	-	-	X	-	X
TP2	Off-delay time	-	-	-	-	-	-	-	-	-	-	-	X	-	X

Timing Chart

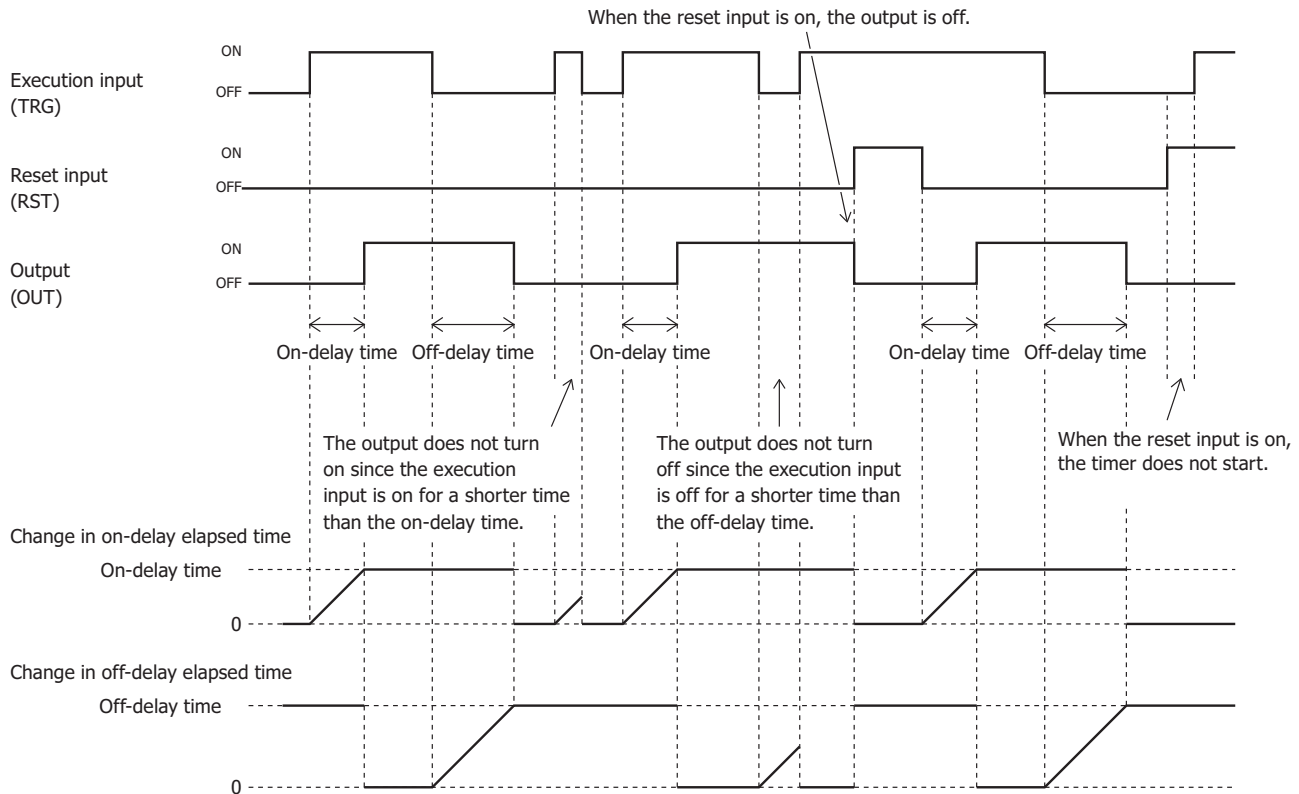

While the reset input (RST) is off and the output (OUT) is off, the current value (on-delay elapsed time) starts being incremented when the execution input turns on.

While the execution input is on, the current value (on-delay elapsed time) is incremented, and when it reaches the on-delay time (TP1), the output (OUT) turns on.

While the reset input is off, the current value (off-delay elapsed time) starts being incremented when the execution input turns off. Even after the execution input turns off, the output keeps on until the current value (off-delay elapsed time) reaches the off-delay time (TP2). When the current value (off-delay elapsed time) reaches the off-delay time (TP2), the output turns off. While the off-delay counting is proceeding, if the execution input turns on, the current value (off-delay elapsed time) returns to 0.

When the reset input is on, the output is off, regardless of the on/off state of the execution input.

Notes:

- T0 to T198 can be used for the timer number. However, for the 12-I/O type, T0 to T98 can be used.
- The on/off-delay timer uses 2 timers. Starting from the timer specified by the timer number, 2 consecutive timers are used. The timer specified with the timer number+0 is allocated for the on-delay time (T1). The timer specified with the timer number+1 is allocated for the off-delay time (T2).
- The preset value can be 0 to 65,535 and specified using a constant or a data register. To indirectly specify the preset value with a data register, specify the data register number where the preset value is stored.

FB	TIMCU 1 sec	TIMCU 100 ms	TIMCU 10 ms	TIMCU 1 ms
The range of Preset value	0 to 65535 seconds	0 to 6553.5 seconds	0 to 655.35 seconds	0 to 65.535 seconds

- The timer numbers (T) already used in any other timer FBs cannot be used.
- If the preset values for the on/off-delay timer are changed during on-delay counting, the timer operates as follows.
 - (1) If the changed on-delay time is larger than the current value, counting continues until the current value reaches the changed on-delay time.
 - (2) If the changed on-delay time is less than or equal to the current value, the output immediately turns on.
 - (3) The changed off-delay time is immediately reflected in timer operation.
- If the preset values for the on/off-delay timer are changed during off-delay counting, the timer operates as follows.
 - (1) If the changed off-delay time is larger than the current value, counting continues until the current value reaches the changed off-delay time.
 - (2) If the changed off-delay time is less than or equal to the current value, the output immediately turns off.
 - (3) The changed on-delay time is immediately reflected in timer operation.
- The preset values can be changed by external devices, such as operator interfaces, WindLDR, and LCD and buttons on the SmartAXIS Pro/Touch. The changed preset values are stored in the RAM, and the changes are not reflected to the user program saved in the ROM. When the SmartAXIS is turned off, the changed preset values are reset to the original values stored in the ROM.
- For details on how to store the changed preset value to the user program in the ROM, see "The timer FB" - "TIMU (On-delay Count Up Timer)" on page 8-1.
- Since the timer has advance error or behind error that error may cause a problem depending on the system. For details, see "The timer FB" - "TIMU (On-delay Count Up Timer)" - "Timer Accuracy" on page 8-3.

SPULS (Single Shot Pulse)

When the execution input turns on, the output turns on according to the operation mode.

Symbol

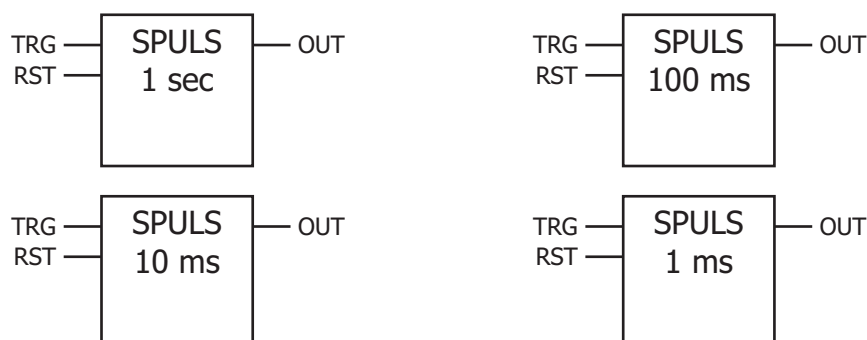

Operation

When the execution input (TRG) turns on while the reset input (RST) is off, the output turns on and the current value starts being incremented. When the current value reaches the preset value, the output turns off.

Applicable SmartAXIS

FT1A-12	FT1A-24	FT1A-40	FT1A-48	FT1A Touch
X	X	X	X	X

Parameters

Parameter		Function	Range	Description
Number	T	Timer number	T0 to T199*1	Unique number to identify the Timer function block. The timer number is automatically assigned in ascending order from zero. The timer number can be changed to a desired number. However, the timer numbers already used in any other Timer FBs cannot be used.
	TRG	Execution input	On/off	When the execution input turns on, the current value returns to 0 and the current value starts being incremented.
Input	RST	Reset input	On/off	The reset input has priority over the execution input. When the reset input is on, the output is off, regardless of the on/off state of the execution input. When unconnected, the reset input is handled as off.
	OUT	Output	-	When the execution input is on, the output is on for the length of time specified by the preset value. When the execution input turns off while the current value is being incremented, the output state is controlled according to the operation mode.
Parameters	TP	Preset value	0 to 65,535	Specify the length of the time from when the output turns on to when it turns off. The preset value can be specified as a constant or a data register.*2
	OP	Operation mode	Input precedence/ time precedence	For input precedence, the output turns off when the execution input turns off (the default is input precedence). For time precedence, even when the execution input turns off, the output keeps on for the length of time specified by the preset value.
	TU	Time unit	1 sec/100 ms/ 10 ms/1 ms	Specify the time unit for the timer.

*1 T0 to T99 for the 12-I/O type.

*2 The preset value can be 0 to 65,535 and specified using a constant or a data register.

To indirectly specify the preset value with a data register, specify the data register number where the preset value is stored.

Valid Devices

Parameter	Function	I	Q	M	R	T	TC	TP	C	CC	CP	B	D	AI	Constant
TRG	Execution input	X	X	X	X	X	-	-	X	-	-	X	-	-	-
RST	Reset input	X	X	X	X	X	-	-	X	-	-	X	-	-	-
TP	Preset value	-	-	-	-	-	-	-	-	-	-	-	X	-	X

Timing Chart

(1) When the operation mode is "input precedence"

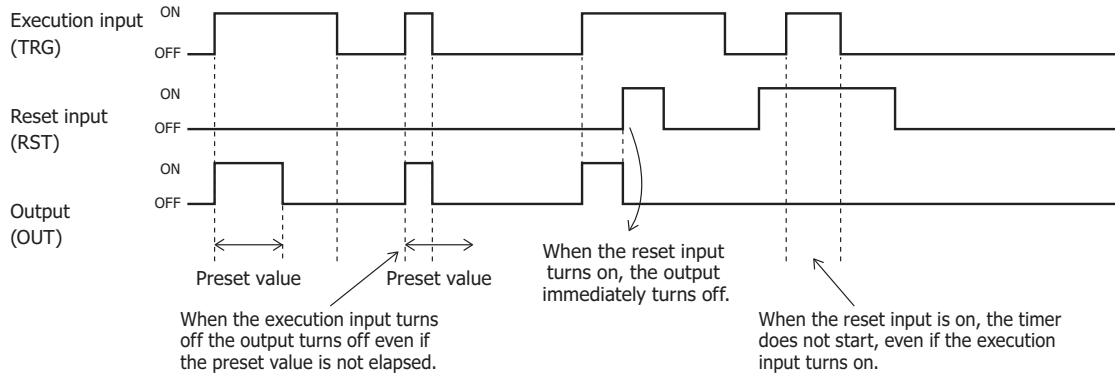

(2) When the operation mode is "time precedence"

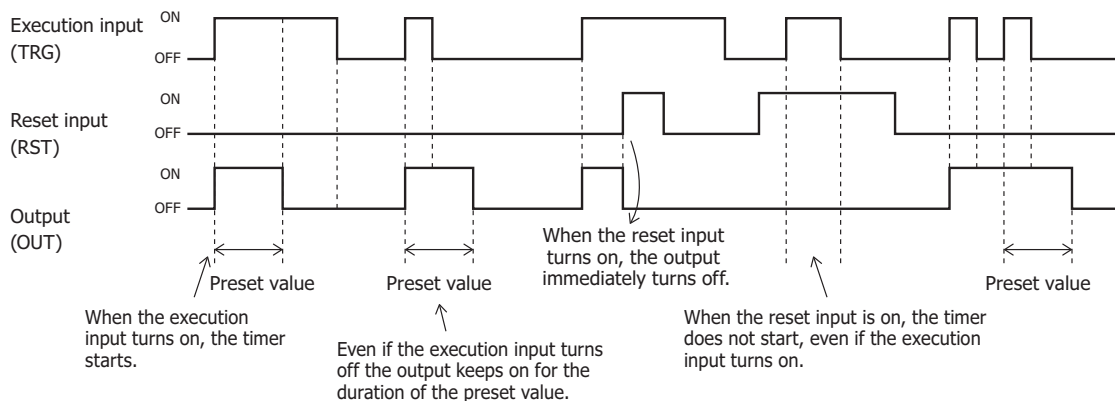

When the execution input (TRG) turns on while the reset input (RST) is off, the current value returns to 0, the output turns on, and the current value starts being incremented. When the current value reaches the preset value (TP), the output (OUT) turns off. The FB operation depends on the operation mode, when the execution input turns off while the current value is being incremented.

(1) When the operation mode is "input precedence"

When the execution input turns off, the output also turns off.

(2) When the operation mode is "time precedence"

Even when the execution input turns off, the output keeps on for the length of time specified by the preset value. When the elapsed time reaches the preset value, the output turns off.

When the reset input turns on, the output immediately turns off.

Notes:

- T0 to T199 can be used for the timer number. However, for the 12-I/O type, T0 to T99 can be used.
- The preset value can be 0 to 65,535 and specified using a constant or a data register. To indirectly specify the preset value with a data register, specify the data register number where the preset value is stored.

FB	SPULS 1 sec	SPULS 100 ms	SPULS 10 ms	SPULS 1 ms
The range of Preset value	0 to 65535 seconds	0 to 6553.5 seconds	0 to 655.35 seconds	0 to 65.535 seconds

- The time number (T) already used in any other timer FBs cannot be used.
- If the preset value for the single shot pulse is changed during counting, the single shot pulse operates as follows.
 - (1) If the changed preset value is larger than the current value, counting continues until the current value reaches the changed preset value.
 - (2) If the changed preset value is less than or equal to the current value, counting stops and the output turns off immediately.
- The preset values can be changed by external devices, such as operator interfaces, WindLDR, and LCD and buttons on the SmartAXIS Pro/Touch. The changed preset values are stored in the RAM, and the changes are not reflected to the user program saved in the ROM. When the SmartAXIS is turned off, the changed preset values are reset to the original values stored in the ROM.
- For details on how to store the changed preset value to the user program in the ROM, see "The timer FB" - "TIMU (On-delay Count Up Timer)" on page 8-1.
- Since the timer has advance error or behind error, that error may cause a problem depending on the system. For details, see "The timer FB" - "TIMU (On-delay Count Up Timer)" - "Timer Accuracy" on page 8-3.

DTIM (Dual Timer)

The output is on for the length of the specified ON time and off for the length of specified OFF time. This operation is repeated.

Symbol

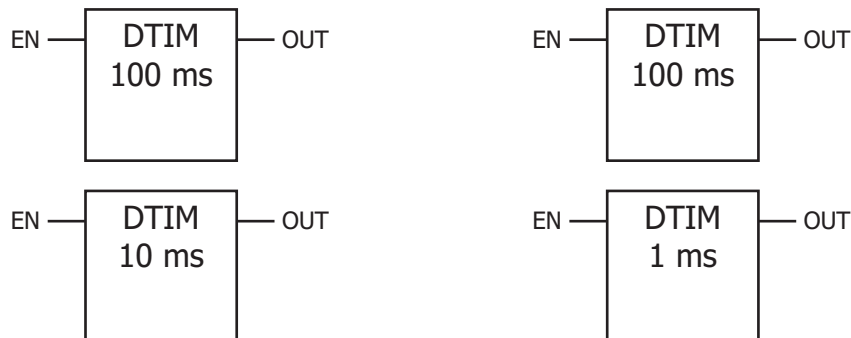

Operation

When the execution input (EN) is on, the output (OUT) is on for the length of the specified ON time (TP1) and off for the length of the specified OFF time (TP2). When the execution input is on, the on/off operation of the output is repeated according to the operation mode. When the execution input is off, the output is off.

Applicable SmartAXIS

FT1A-12	FT1A-24	FT1A-40	FT1A-48	FT1A Touch
X	X	X	X	X

Parameters

Parameter	Function	Range	Description	
Number	T	Timer number	T0 to T197*1	Unique number to identify the Timer function block. The timer number is automatically assigned in ascending order from zero. The timer number can be changed to a desired number. However, the timer numbers already used in any other Timer FBs cannot be used.
Input	EN	Execution input	On/off	When the execution input turns on, the current value (ON time elapsed time) starts being incremented. When the execution input is on, the output keeps on until the current value reaches the ON time (TP1). Then the current value (OFF time elapsed time) starts being incremented, and the output is off until it reaches the OFF time (TP2). While the execution input is on, the on/off operation of the output (i.e. pulse output) is repeated according to the operation mode. When the execution input is off, the output is off.
Output	OUT	Output	-	When the execution input is on, the output is turned on and off in a cycle according to the configured parameters. When the execution input is off, the output is off.
Parameters	TP1	ON time	0 to 65,535	Specify the length of time that the output is on. The ON time value can be specified as a constant or a data register.*2
	TP2	OFF time	0 to 65,535	Specify the length of time that the output is off. The OFF time value can be specified as a constant or a data register.*2
	TP3	Pulse number/time	0 to 65,535	Specify the pulse number or the pulse output time. The value can be specified as a constant or a data register.*2. When continuance is selected as the operation mode, this parameter is disabled.
	OP	Operation mode	Pulse number restriction/output time restriction/continuance	<ul style="list-style-type: none"> For the pulse number restriction, when the execution input is on, the specified number of pulses are output and then the output turns off. For the output time restriction, when the execution input is on, pulses are output until the elapsed time reaches the specified time. When the elapsed time reaches the specified time, the output turns off. For continuance, pulses are continuously output while the execution input is on. When the execution input turns off, the output turns off (the default operation mode is continuance).
	TU	Time unit	1 sec/100 ms/10 ms/1 ms	Specifies the time unit for the timer.

*1 T0 to T97 for the 12-I/O type.

*2 The preset value can be 0 to 65,535 and specified using a constant or a data register.

To indirectly specify the preset value with a data register, specify the data register number where the preset value is stored.

Valid Devices

Parameter	Function	I	Q	M	R	T	TC	TP	C	CC	CP	B	D	AI	Constant
EN	Execution input	X	X	X	X	X	-	-	X	-	-	X	-	-	-
TP1	ON time	-	-	-	-	-	-	-	-	-	-	-	X	-	X
TP2	OFF time	-	-	-	-	-	-	-	-	-	-	-	X	-	X
TP3	Pulse number/time	-	-	-	-	-	-	-	-	-	-	-	X	-	X

Timing Chart

(1) When the operation mode is "continuance"

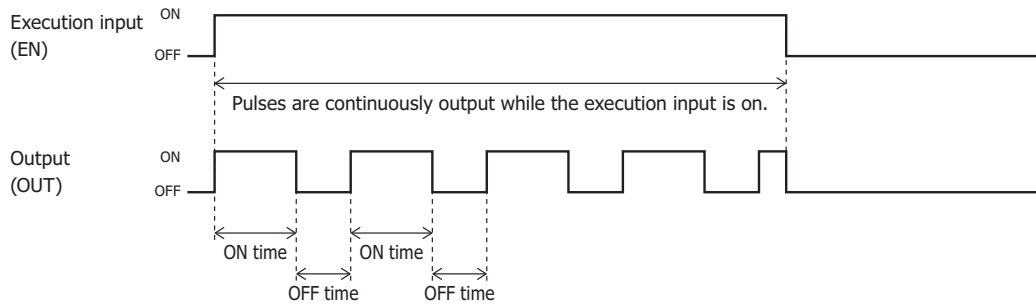

(2) When the operation mode is "pulse number restriction"

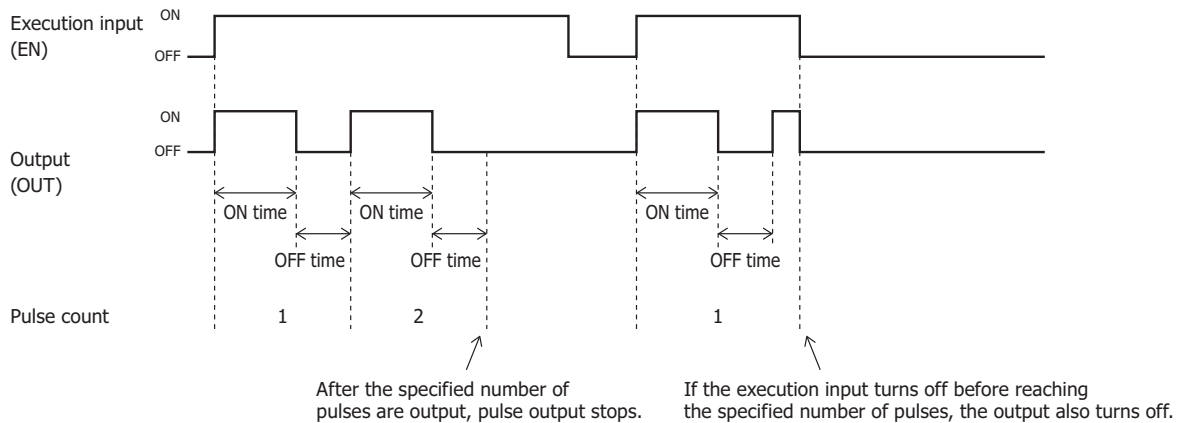

(3) When the operation mode is "output time restriction"

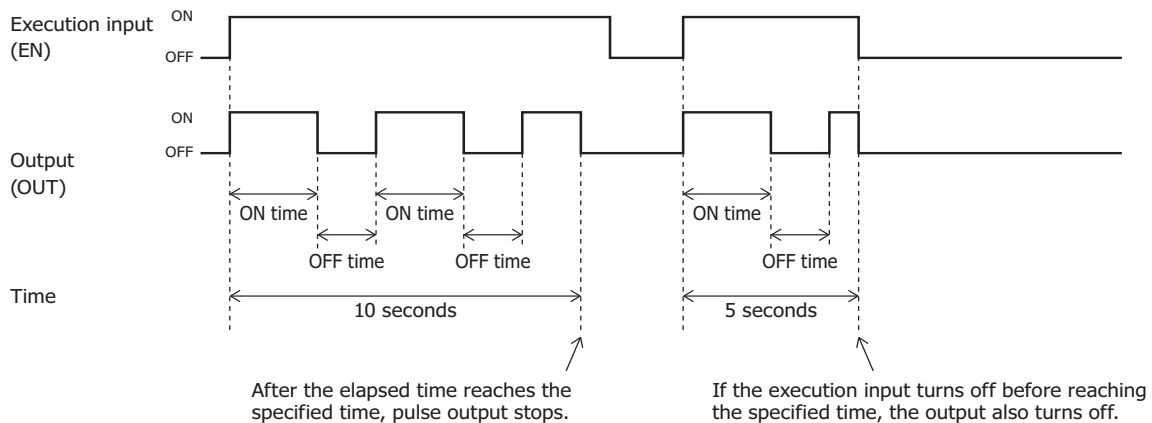

When the execution input (EN) is off, the current value returns to 0.

When the execution input (EN) turns on, the current value (ON time elapsed time) starts being incremented. According to the operation mode, the output is on for the duration of ON time (TP1) and off for the duration of OFF time (TP2).

(1) When the operation mode is "continuance"

While the execution input is on, the on/off operation of the output is repeated.

(2) When the operation mode is "pulse count restriction"

When the execution input is on, the on/off operation of the output is repeated for the specified number of pulses (TP3).

(3) When the operation mode is "output time restriction"

When the execution input is on, the on/off operation of the output is repeated for the specified time (TP3).

When the execution input is off, the output is off.

8: THE TIMER FB

Notes:

- T0 to T197 can be used for the timer number. However, for the 12-I/O type, T0 to T97 can be used.
The dual timer uses 3 timers. Starting from the timer specified by the timer number, 3 consecutive timers are used. The timer specified with the timer number+0 is allocated for the ON time (T1). The timer specified with the timer number+1 is allocated for the OFF time (T2). The timer specified with the timer number+2 is allocated for the pulse count/time (T3).
- The preset value can be 0 to 65,535 and specified using a constant or a data register.
To indirectly specify the preset value with a data register, specify the data register number where the preset value is stored.

FB	DTIM 1 sec	DTIM 100 ms	DTIM 10 ms	DTIM 1 ms
The range of Preset value	0 to 65535 seconds	0 to 6553.5 seconds	0 to 655.35 seconds	0 to 65.535 seconds

- The time numbers (T) already used in any other timer FBs cannot be used.
- When each preset value is changed during ON time, OFF time, or operation mode "output time restriction" or "pulse number restriction" counting, the change is immediately reflected in operation.
- If the ON time value or the OFF time value of the dual timer is changed during counting, the dual timer operates as follows.
 - (1) If the changed ON time (TP1) is larger than the current value, the ON time counting continues until the current value reaches the changed ON time.
 - (2) If the changed ON time (TP1) is less than or equal to current value, the output immediately turns off and the OFF time counting starts.
 - (3) If the changed OFF time (TP2) is larger than the current value, the OFF time counting continues until the current value reaches the changed OFF time.
 - (4) If the changed OFF time (TP2) is less than or equal to the current value, the output immediately turns on and the ON time counting starts.
- The preset values can be changed by external devices, such as operator interfaces, WindLDR, and LCD and buttons on the SmartAXIS Pro/Touch. The changed preset values are stored in the RAM, and the changes are not reflected to the user program saved in the ROM. When the SmartAXIS is turned off, the changed preset values are reset to the original values stored in the ROM.
- For details on how to store the changed preset values to the user program in the ROM, see "The timer FB" - "TIMU (On-delay Count Up Timer)" on page 8-1.
- Since the timer has advance error or behind error, that error may cause a problem depending on the system. For details, see "The timer FB" - "TIMU (On-delay Count Up Timer)" - "Timer Accuracy" on page 8-3.

RPULS (Random Pulse Output)

The output is on for the length of random time within the configured range of time.

Symbol

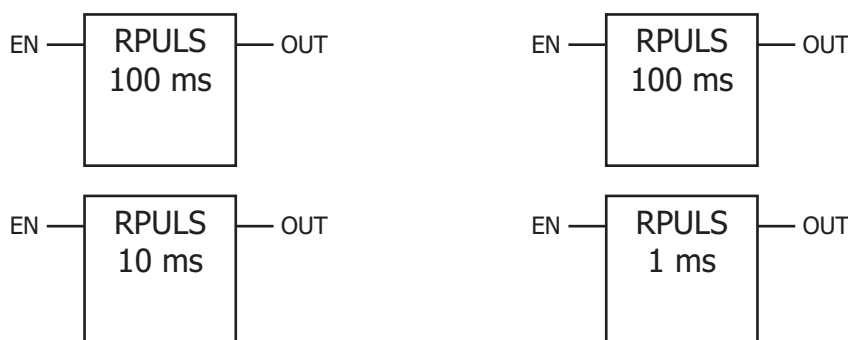

Operation

When the execution input (EN) turns on, the output (OUT) turns on for a random time within the range between the ON time maximum (TP1) and ON time minimum (TP2).

Then the output turns off for the remaining time of the specified cycle (TP3).

When the execution input is off, the output is off.

Applicable SmartAXIS

FT1A-12	FT1A-24	FT1A-40	FT1A-48	FT1A Touch
X	X	X	X	X

Parameters

Parameter	Function	Range	Description
Number	T	Timer number	T0 to T197*1
Input	EN	Execution input	On/off
Output	OUT	Output	–
Parameters	TP1	ON time maximum	0 to 65,535
	TP2	ON time minimum	0 to 65,535
	TP3	Cycle*3	0 to 65,535
	OP	Operation mode	Single-pulse/ continuance
	TU	Time unit	1 sec/100 ms/ 10 ms/1 ms

*1 T0 to T97 for the 12-I/O type.

*2 The preset value can be 0 to 65,535 and specified using a constant or a data register.

To indirectly specify the preset value with a data register, specify the data register number where the preset value is stored.

*3 The cycle is only effective when continuance is selected as the operation mode. The cycle setting is not necessary when single-pulse is selected as the operation mode.

Valid Devices

Parameter	Description	I	Q	M	R	T	TC	TP	C	CC	CP	B	D	AI	Constant
EN	Execution input	X	X	X	X	X	–	–	X	–	–	X	–	–	–
TP1	ON time maximum	–	–	–	–	–	–	–	–	–	–	–	X	–	X
TP2	ON time minimum	–	–	–	–	–	–	–	–	–	–	–	X	–	X
TP3	Cycle	–	–	–	–	–	–	–	–	–	–	–	X	–	X

Timing Chart

(1) When the operation mode is "single-pulse"

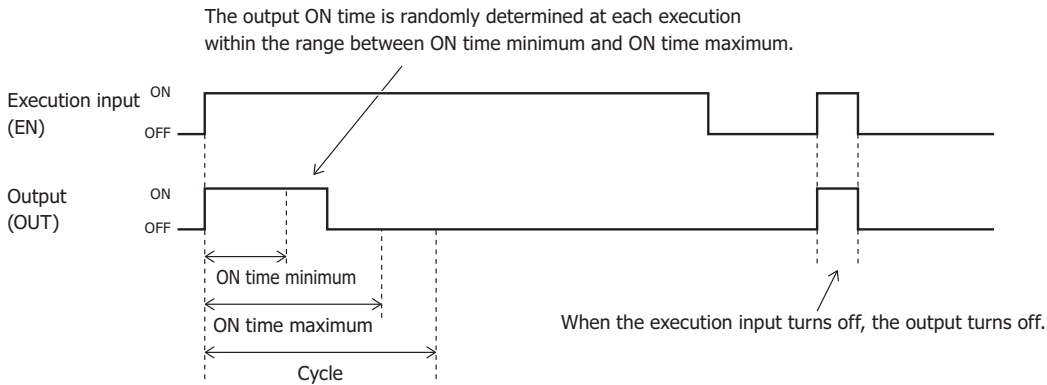

If "single-pulse" is selected as the operation mode, the output (OUT) turns on for a random time within the range of time between ON time minimum and ON time maximum when the execution input (EN) turns on. Then afterward, the output turns off and remains off.

(2) When the operation mode is "continuance"

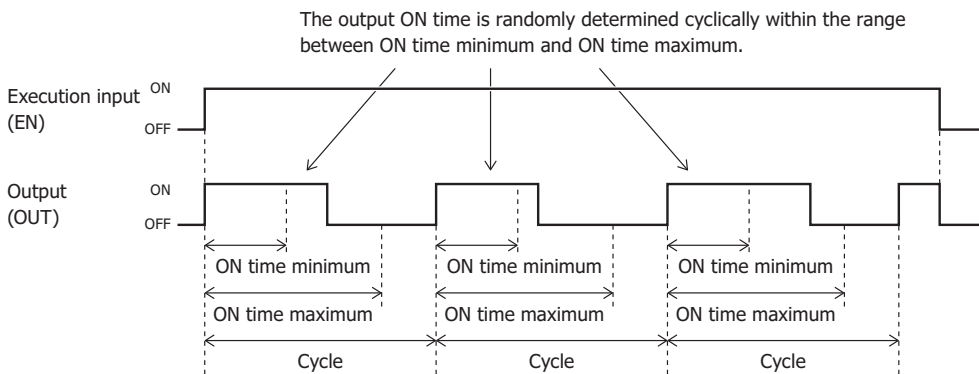

If "continuance" is selected as the operation mode, the on/off operation of pulse output (i.e. pulse output) is repeated at the specified cycle (TP3) while the execution input is on. The output turns on for a random time within the range of time between ON time minimum and ON time maximum, and then the output turns off for the remaining time of the cycle. When the execution input turns off, the output turns off.

Notes:

- When ON time maximum (TP1) < ON time minimum (TP2), a user program execution error occurs and the output turns off.
- When the cycle (TP3) < ON time maximum (TP1), a user program execution error occurs and the output turns off.
- When the ON time maximum is set to 1, the ON time minimum is set to 0, and the cycle is set to 1, the output repeatedly and randomly turns on or off for the time length of the cycle. The output does not turn on and off within the cycle.
- T0 to T197 can be specified for the timer number. However, for the 12-I/O type, T0 to T97 can be used. The random pulse output uses 3 timers. Starting from the timer specified by the timer number, 3 consecutive timers are used. The timer specified with the timer number+0 is allocated for the ON time maximum (T1). The timer specified with the timer number+1 is allocated for the OFF time maximum (T2). The timer specified with the timer number+2 is allocated for the cycle (T3).
- The preset value can be 0 to 65,535 and specified using a constant or a data register. To indirectly specify the preset value with a data register, specify the data register number where the preset value is stored.

FB	RPULS 1 sec	RPULS 100 ms	RPULS 10 ms	RPULS 1 ms
The range of Preset value	0 to 65535 seconds	0 to 6553.5 seconds	0 to 655.35 seconds	0 to 65.535 seconds

- The time numbers (T) already used in any other timer FBs cannot be used.
- If ON time maximum value, ON time minimum value, or cycle value are changed during counting, the changes are reflected in operation from the next cycle.
- The preset values can be changed by external devices, such as operator interfaces, WindLDR, and LCD and buttons on the SmartAXIS Pro/Touch. The changed preset values are stored in the RAM, and the changes are not reflected to the user program saved in the ROM. When the SmartAXIS is turned off, the changed preset values are reset to the original values stored in the ROM.
- For details on how to store the changed preset values to the user program in the ROM, see "The timer FB" - "TIMU (On-delay Count Up Timer)" on page 8-1.
- Since the timer has advance error or behind error, that error may cause a problem depending on the system. For details, see "The timer FB" - "TIMU (On-delay Count Up Timer)" - "Timer Accuracy" on page 8-3.

9: THE COUNTER FB

The counter FBs count the input pulses or measure the ON time of an input, compare the current value with the preset value, and output the comparison result.

CNT (Adding Counter)

The CNT FB increments the current value by one when the up clock input turns on. The output turns on when the current value is equal to or greater than the preset value.

Symbol

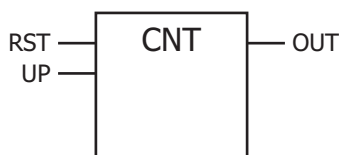

Operation description

When the reset input (RST) is off, the CNT FB can count the input pulses. While the CNT FB is in countable state, the CNT FB increments the current value by one at every rising edge in the up clock input (UP). When the current value reaches the preset value, counting is stopped, and the output (OUT) is maintained until the reset input is turned on. When the reset input is on, the current value is reset to 0, and the output is turned off.

Applicable SmartAXIS

FT1A-12	FT1A-24	FT1A-40	FT1A-48	FT1A Touch
X	X	X	X	X

Parameters

Parameter	Function	Range	Description	
Number	C	Counter number	C0 to C199*1	Unique number to identify each counter FB. The counter number is automatically assigned in ascending order from zero. The counter number can be changed to a desired number. However, the counter numbers already used in any other counter FBs cannot be used.
Input	RST	Reset input	On/off	The reset input is executed with a higher precedence than the up clock input. When the reset input is on, the current value is reset to zero and the output is turned off. When the reset input is off, the CNT FB can count the input pulses. When unconnected, the reset input is handled as off.
	UP	Up clock input	On/off	The current value is incremented by one at a rising edge in the up clock input.
Output	OUT	Output	–	The output is turned on when the current value is equal to or greater than the preset value. The output is turned off when the current value is smaller than the preset value.
Parameters	CP	Preset value	W (word): 0 to 65,535 D (double word): 0 to 4,294,967,295	The value at which the output is turned on.*2 The value can be specified as a constant or a data register.
	OP	Data type	W (word): 0 to 65,535 D (double word): 0 to 4,294,967,295	If the data type is W, the counter can count in the range of 0 to 65,535. If the data type is D, the counter can count in the range of 0 to 4,294,967,295.

*1 C0 to C99 for the 12-I/O type.

*2 The valid range differs according to the data type specified by OP.

When the data type is W (word):

Specify a constant value in the range of 0 to 65,535. To indirectly specify the preset value with a data register, specify the data register in which the preset value is stored, and store a constant value in the data register in the range of 0 to 65,535.

When the data type is D (double word):

Specify a constant value in the range of 0 to 4,294,967,295. To indirectly specify the preset value with a data register, specify the data register in which the preset value is stored, and store a constant value in the data register in the range of 0 to 4,294,967,295.

Valid Devices

Parameter	Function	I	Q	M	R	T	TC	TP	C	CC	CP	B	D	AI	Constant
RST	Reset input	X	X	X	X	X	–	–	X	–	–	X	–	–	–
UP	Up clock input	X	X	X	X	X	–	–	X	–	–	X	–	–	–
CP	Preset value	–	–	–	–	–	–	–	–	–	–	–	X	–	X

Timing Chart

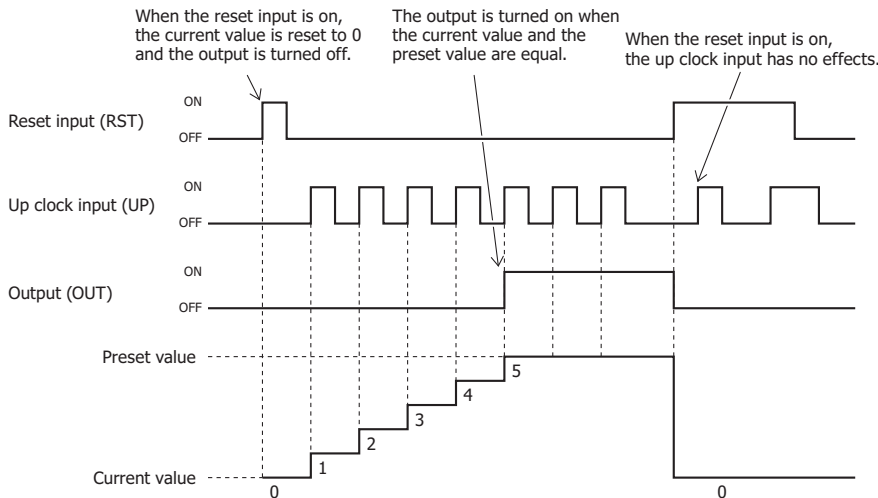

When the reset input is off, the counter is in the countable state. While the counter is in the countable state, it increments the current value at every rising edge in the up clock input.

When the current value reaches the preset value, the counting ends, and the output is kept on until the reset input is turned on. After the counting ends, the current value does not change even when the up clock input is turned on.

When the reset input (RST) is on, the current value is reset to 0 and the output (OUT) is turned off regardless of the on/off state of the up clock input (UP).

Relationship between the up clock input and the reset input

The reset input has a higher precedence than the up clock input. The up clock input is enabled when one scan has elapsed after the reset input changes from on to off.

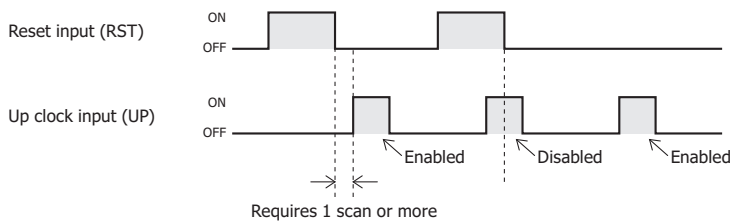

Notes:

- C0 to C199 can be used for the counter number. For the 12-I/O type, C0 to C99 can be used.
- The counter numbers already used in any other counter FBs cannot be used.
- When the adding counter (CNT) is in the count up state, the current value does not change even when the up clock input is turned on.
- When the preset value or the current value of the adding counter (CNT) FB is changed, the FB behaves as follows.

Operation	Adding counter behavior
When the current value or the preset value is changed in the count up state and the preset value is not equal the current value	The count up state is maintained.
When the current value becomes greater than the preset value while the CNT FB is not in the count up state	The CNT FB counts up immediately and the output is turned on.
When the preset value is set to 0	The output is turned on regardless of the current value.
When the preset value is set to 0 while the reset input is on	The count is ended but the output is not turned on.

- The preset values can be changed by external devices, such as operator interfaces, WindLDR, and LCD and buttons on the SmartAXIS Pro/Touch. The changed preset values are stored in the RAM, and the changes are not reflected to the user program saved in the ROM. When the SmartAXIS is turned off, the changed preset values are reset to the original values stored in the ROM.
- To store the changed preset values to the user program in ROM, use one of the following methods.

Store the preset values to the user program in the ROM using WindLDR (SmartAXIS Pro/Lite only).

Select **Online > Monitor > Start Monitor**. Select **Online > PLC > Status** to open the PLC Status dialog box, and click the **Confirm** button under **Timer/counter preset value change state**. Once the changed preset values are confirmed, the preset values cannot be changed back to its original values, even if you click the **Cancel** button.

Store the preset values to the user program in the ROM with button operations on the SmartAXIS.

For operations on the SmartAXIS Pro, see Chapter 6 "HMI Function" in the "SmartAXIS Pro/Lite User's Manual". For operations on the SmartAXIS Touch, see the "SmartAXIS Touch User's Manual".

CUD (Up/Down Selection Reversible Counter)

The CUD FB increments or decrements the current value at every rising edge in the clock input. Whether the current value is incremented or decremented is determined by the state of the up/down selection input. The current values are compared with the ON and OFF thresholds, and the output is turned on or off according to the comparison result.

Symbol

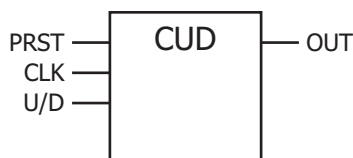

Operation description

When the preset input (PRST) is on, the initial value is stored to the current value, and the output (OUT) is turned off. When the preset input is off, the counter is in the countable state.

While the counter is in the countable state, the CUD FB increments or decrements the current value at every rising edge in the clock input (CLK).

When the up/down selection input (U/D) is on, the counter is decremented by 1.

When the up/down selection input (U/D) is off, the counter is incremented by 1.

The current value is compared with the ON and OFF thresholds, and the result is output.

Applicable SmartAXIS

FT1A-12	FT1A-24	FT1A-40	FT1A-48	FT1A Touch
X	X	X	X	X

Parameters

Parameter	Function	Range	Description	
Number	C	Counter number	C0 to C197*1	Unique number to identify each counter FB. The counter number is automatically assigned in ascending order from zero. The counter number can be changed to a desired number. However, the counter numbers already used in any other FBs cannot be used.
Input	PRST	Preset input	On/off	The preset input is executed with a higher precedence than the clock input. When the preset input is on, the initial value is stored to the current value, and the output is turned off. When the preset input is off, the counter FB is in the countable state. When unconnected, the preset input is handled as off.
	CLK	Clock input	On/off	The current value is incremented or decremented by 1 at every rising edge in the clock input. Whether to increment or decrement is determined by the on/off state of the up/down selection input.
	U/D	Up/down selection input	On/off	When the up/down selection input is on, the current value is decremented by 1 at every rising edge in the clock input. When the up/down selection input is off, the current value is incremented by 1 at every rising edge in the clock input.
Output	OUT	Output	–	The current value is compared with the ON and OFF thresholds, and the result is output.
Parameters	CP1	Initial value	W (word): 0 to 65,535 D (double word): 0 to 4,294,967,295	When the preset input is on, the initial value is stored in the current value*2. The value can be specified as a constant or a data register.
	CP2	ON threshold	W (word): 0 to 65,535 D (double word): 0 to 4,294,967,295	The ON threshold*2. The value can be specified as a constant or a data register.
	CP3	OFF threshold	W (word): 0 to 65,535 D (double word): 0 to 4,294,967,295	The OFF threshold*2. The value can be specified as a constant or a data register.
	OP	Data type	W (word)/ D (double word)	If the data type is W, the countable range is 0 to 65,535. If the data type is D, the countable range is 0 to 4,294,967,295.

*1 The valid range differs according to the SmartAXIS type and the data type specified by OP.

12-I/O type:

If the data type is W (word), 3 counters are used, and the counter number can be specified in the range of C0 to C97.

If the data type is D (double word), 6 counters are used, and the counter number can be specified in the range of C0 to C94.

24-, 40-, 48-I/O types, SmartAXIS Touch:

If the data type is W (word), 3 counters are used, and the counter number can be specified in the range of C0 to C197.

If the data type is D (double word), 6 counters are used, and the counter number can be specified in the range of C0 to C194.

*2 The valid range differs according to the data type specified by OP.

When the data type is W (word):

For a constant, set the value in the range of 0 to 65,535. To indirectly specify the value with a data register, specify it with the data register number where the value is stored, and specify the content of the data register in the range of 0 to 65,535.

When the data type is D (double word):

For a constant, set the value in the range of 0 to 4,294,967,295. To indirectly specify the value with a data register, specify it with the data register number where the value is stored, and specify the content of the data register in the range of 0 to 4,294,967,295.

Valid Devices

Parameter	Function	I	Q	M	R	T	TC	TP	C	CC	CP	B	D	AI	Constant
PRST	Preset input	X	X	X	X	X	-	-	X	-	-	X	-	-	-
CLK	Clock input	X	X	X	X	X	-	-	X	-	-	X	-	-	-
U/D	Up/down selection input	X	X	X	X	X	-	-	X	-	-	X	-	-	-
CP1	Initial value	-	-	-	-	-	-	-	-	-	-	-	X	-	X
CP2	ON threshold	-	-	-	-	-	-	-	-	-	-	-	X	-	X
CP3	OFF threshold	-	-	-	-	-	-	-	-	-	-	-	X	-	X

Timing Chart

When the preset input (PRST) is on, the initial value is stored to the current value, and the output (OUT) is turned off.

When the preset input is off, the counter is in the countable state.

While the counter is in the countable state, the counter FB increments or decrements the current value by 1 at every rising edge in the clock input (CLK).

When the up/down selection input (U/D) is on, the current value is decremented by 1.

When the up/down selection input (U/D) is off, the current value is incremented by 1.

The output is turned on or off when the current value is in the following conditions:

- When ON threshold \geq OFF threshold

The output is turned on when the current value is equal to or greater than the ON threshold. The output is turned off when the current value is smaller than the OFF threshold.

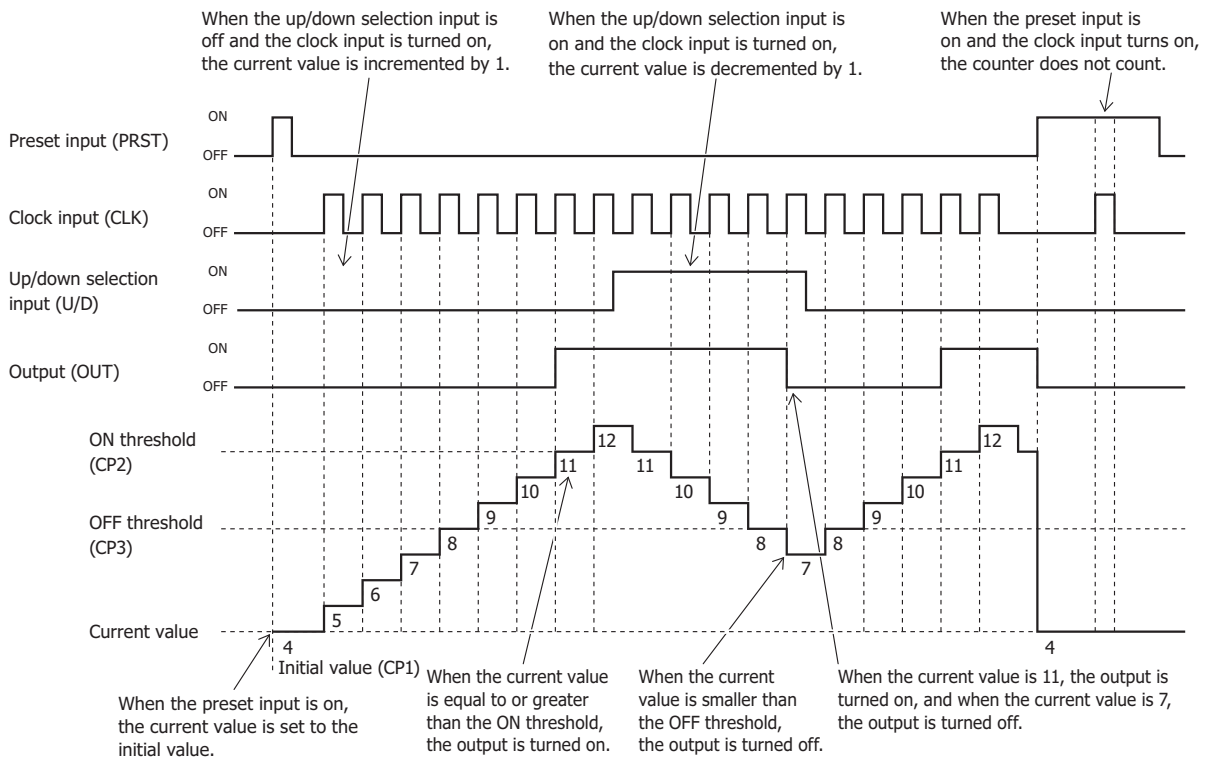

- When ON threshold < OFF threshold

The output turns on when the current value is equal to or greater than the ON threshold and is smaller than the OFF threshold. The output turns off when the current value is smaller than the ON threshold or is equal to or greater than the OFF threshold.

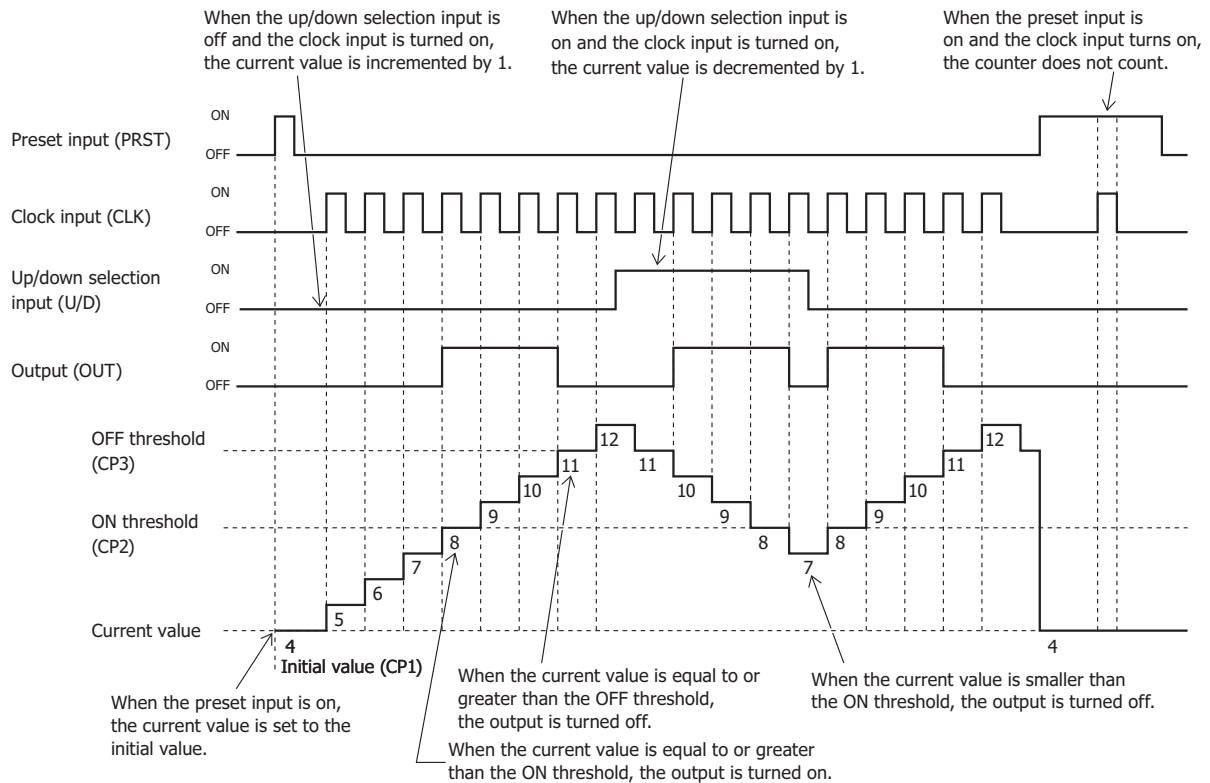

Relationship between the clock input and the preset input

The preset input has a higher precedence than the clock input. The clock input is enabled when one scan has elapsed after the preset input changes from on to off.

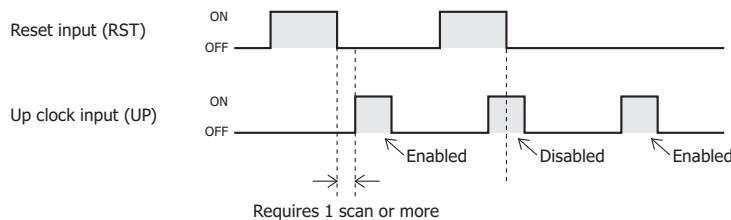

Notes:

- C0 to C197 can be used as the counter number when the data type is specified as W (word). C0 to C97 can be used for the 12-I/O type. Since 6 counters (C) are used when the data type is specified as D (double word), C0 to C194 can be used. C0 to C94 can be used for the 12-I/O type.
- The counters used by the up/down selection reversible counter are allocated to the initial value, ON threshold, and OFF threshold in order starting from the specified counter number as shown below.

W (word)

Counter	Content	Configurable range
Start counter (C)+0	Initial value	0 to 65,535
Start counter (C)+1	ON threshold	
Start counter (C)+2	OFF threshold	

D (double word)

Counter	Content	Configurable range
Start counter (C)+0	Initial value	0 to 4,294,967,295
Start counter (C)+1		
Start counter (C)+2	ON threshold	
Start counter (C)+3	OFF threshold	
Start counter (C)+4		
Start counter (C)+5		

Notes:

- Counters (C) already used in other counter FBs cannot be used.
- When the current value of the up/down selection reversible counter is the maximum, 65,535 or 4,294,967,295, the current value cannot be incremented.
- When the current value of the up/down selection reversible counter is 0, the current value cannot be decremented.
- Turn on the preset input at least once before start using the up/down reversible counter. If the preset input is never turned on, the current value will contain an unknown value.
- The preset values can be changed by external devices, such as operator interfaces, WindLDR, and LCD and buttons on the SmartAXIS Pro/Touch. The changed preset values are stored in the RAM, and the changes are not reflected to the user program saved in the ROM. When the SmartAXIS is turned off, the changed preset values are reset to the original values stored in the ROM.
For details on how to store the changed preset values to the user program in ROM, "CNT (Adding Counter)" on page 9-1 - "Store the preset values to the user program in the ROM using WindLDR (SmartAXIS Pro/Lite only)." on page 9-2 and "Store the preset values to the user program in the ROM with button operations on the SmartAXIS." on page 9-2.

HOUR (Hour Meter)

The HOUR FB measures and accumulates the ON time (hours, minutes, seconds) of the execution input. The output is turned on when the accumulated time reaches the preset value.

Symbol

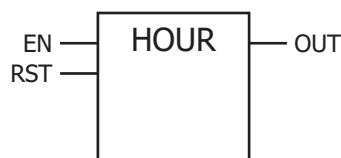

Operation description

When the execution input (EN) is on, the ON time (hours, minutes, seconds) of the execution input is measured and accumulated. When the accumulated time is equal to or greater than the specified preset value (hours, minutes, seconds), the output (OUT) is turned on. The accumulated ON time and the preset value (hours, minutes, seconds) use 3 devices.

In the preset value, "Hours" can be configured in the range of 0 to 65,535 and the "Minutes" and "Seconds" can be configured in the range of 0 to 59.

Notes:

When the accumulated ON time of the execution input exceeds 65,535 hours, 59 minutes, and 59 seconds, 65536 is subtracted from the accumulated ON time stored in the specified devices.

Among the preset value "Hours", "Minutes", and "Seconds" data, if one of those data is out of the valid range, a user program execution error occurs and the output turns off. However, measuring the accumulated ON time continues.

For user program execution errors, see the following chapters.

- "SmartAXIS Pro/Lite User's Manual" - Chapter 14 "User Program Execution Error"
- "SmartAXIS Touch User's Manual" - Chapter 30 "Troubleshooting"

Applicable SmartAXIS

FT1A-12	FT1A-24	FT1A-40	FT1A-48	FT1A Touch
X	X	X	X	X

Parameters

Parameter	Function	Range	Description	
Number	C	Counter number	C0 to C197*1	Unique number to identify each counter FB. The counter number is automatically assigned in ascending order from zero. The counter number can be changed to a desired number. However, the counter numbers already used in any other FBs cannot be used.
Input	EN	Execution input	On/off	When the reset input is off and the execution input is on, the ON time (hours, minutes, seconds) of the execution input is measured and accumulated. When the reset input is on, the ON time of the execution input is not measured.
	RST	Reset input	On/off	The reset input is executed with a higher precedence than the execution input. When the reset input is on, the accumulated ON time is reset to "0 hours 0 minutes 0 seconds", and the output is turned off. When unconnected, the reset input is handled as off.
Output	OUT	Comparison output	–	When the accumulated ON time of the execution input is equal to or greater than the preset value, the output is turned on.
Parameters	CP	Preset value	0 hours 0 minutes 0 seconds to 65535 hours 59 minutes 59 seconds	The preset value can be specified as constants or data registers.*2 The value can be specified as a constant or a data register.
	OP	Operation mode	Keep output/clear output	One of the following two operations can be specified for when the accumulated time exceeds the preset value, the output is on, and the execution input is turned off. (1) Keep: When the execution input is turned off, the output state is maintained. The output is maintained until the reset input is turned on. (2) Clear: When the execution input is turned off, the output is turned off. The default is (1).

*1 C0 to C97 for the 12-I/O type.

*2 Three consecutive counters starting with the specified counter number are used. The preset value "Hours", "Minutes", and "Seconds" are stored in those counters in order.

To indirectly specify the preset value with data registers, specify the start data register of the data registers where the values are stored. The preset value uses three consecutive data registers, and "Hours", "Minutes", and "Seconds" are stored in those data registers in order. The range of start data register is D0 to D997 and D1000 to D1997. However, the range is D0 to D397 for the 12-I/O type.

The "Hours" can be configured in the range of 0 to 65535, and the "Minutes" and "Seconds" can be configured in the range of 0 to 59.

Valid Devices

Parameter	Function	I	Q	M	R	T	TC	TP	C	CC	CP	B	D	AI	Constant
EN	Execution input	X	X	X	X	X	-	-	X	-	-	X	-	-	-
RST	Reset input	X	X	X	X	X	-	-	X	-	-	X	-	-	-
CP	Preset value	-	-	-	-	-	-	-	-	-	-	-	X	-	X

Timing Chart

- When the selected operation mode is "Clear Output"

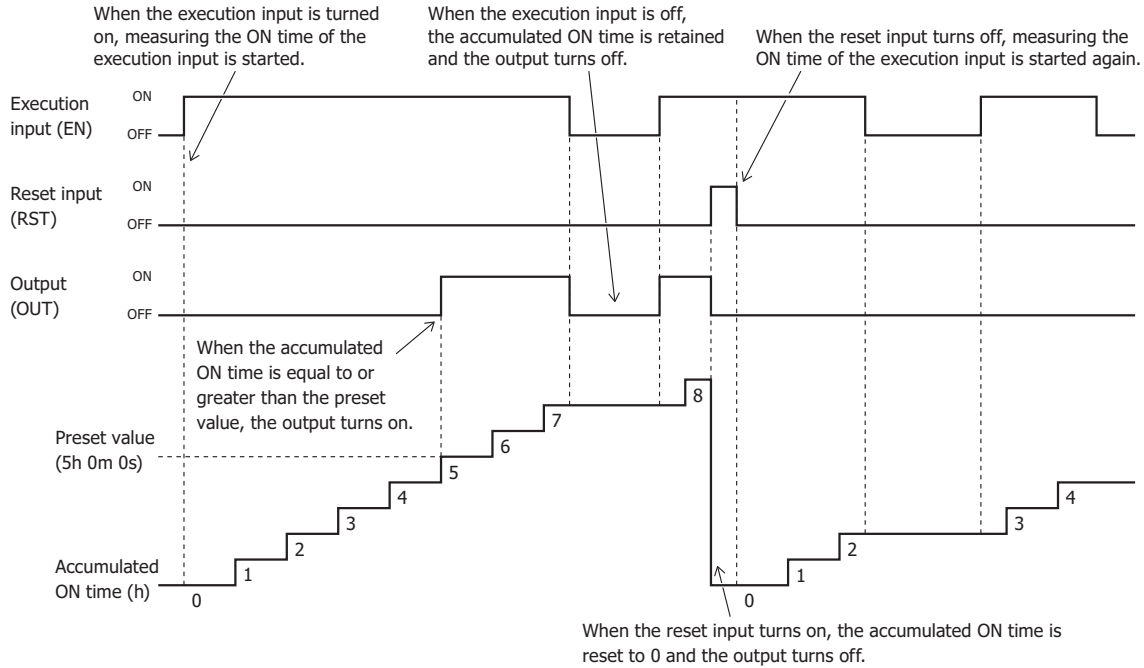

- When the selected operation mode is "Keep Output"

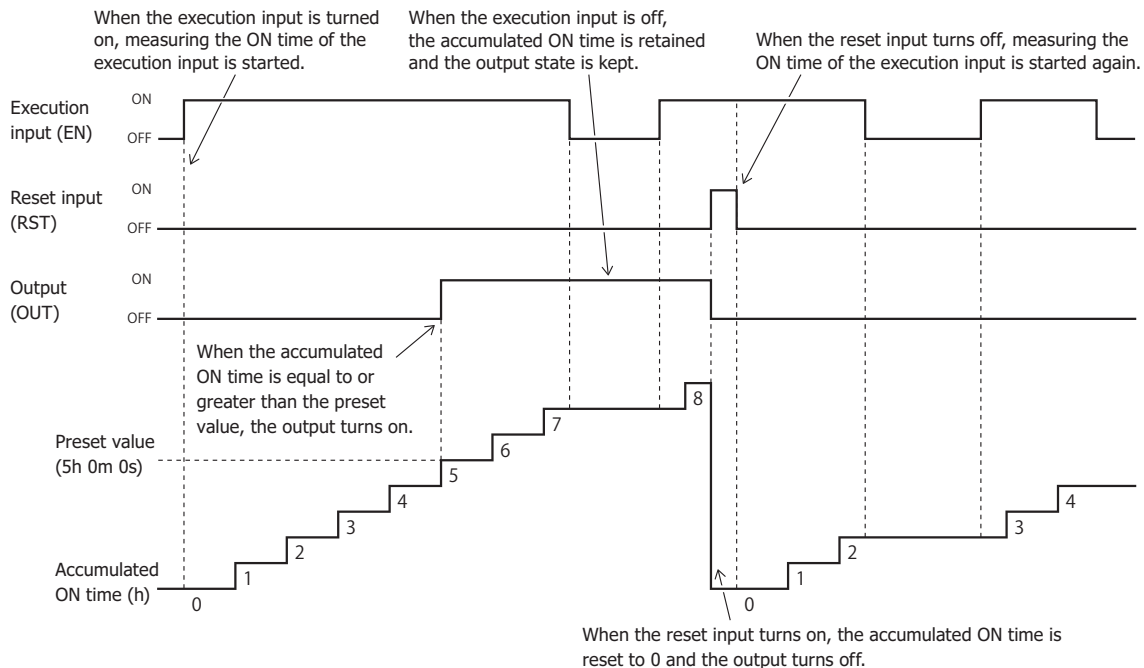

When the reset input (RST) is off and the execution input (EN) is on, the ON time of the execution input (hours, minutes, seconds) is measured and accumulated. The output (OUT) is turned on when the accumulated ON time is equal to or greater than the preset value configured in CP.

When the output is on and the execution input is turned off, the output is kept on or turned off according to the operation mode specified by OP. The accumulated ON time is retained even when the execution input is off.

When the reset input is on, the accumulated ON time is reset to 0 hours 0 minutes 0 seconds, and the output is turned off, regardless of the on/off state of the execution input.

10: THE SHIFT REGISTER FB

This chapter describes the shift register FB of the SmartAXIS series.

SFR (Shift Register)

Shifts as many shift registers as the number of constituent bits starting from the specified shift register according to the direction input.

Symbol

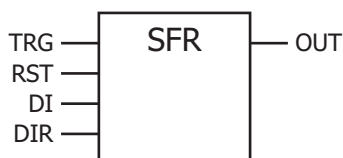

Operation

When the reset input (RST) is off and the execution input (TRG) is turned on, shift registers as many as the number of constituent bits starting with the specified shift register are shifted by 1 bit according to the on/off state of the direction input (DIR). At the same time, the on/off state of the data input (DI) is stored in the LSB (least significant bit) or the MSB (most significant bit).

- When the direction input is off, the shift registers are shifted in ascending order (R0 > R1 > R2...). The on/off state of the data input is stored in the LSB (least significant bit) of the shift registers.
- When the direction input is on, the shift registers are shifted in descending order (R127 > R126 > R125...). The on/off state of the data input is stored in the MSB (most significant bit) of the shift registers.

When the reset input is on, the shift registers are set to 0.

Applicable SmartAXIS

FT1A-12	FT1A-24	FT1A-40	FT1A-48	FT1A Touch
X	X	X	X	X

Parameters

Parameter	Function	Range	Description	
Number	B	Block number	B0 to B999*1	Unique number to identify each function block. The block number is automatically assigned in ascending order from zero. The block number can be changed to a desired number. However, the block numbers already used in any other FBs cannot be used.
Input	TRG	Execution input	On/off	With a rising edge in the execution input, the shift operation is performed.
	RST	Reset input	On/off	When the reset input is on, the shift registers are set to 0. The reset input is executed with a higher precedence than the execution input. Unconnected inputs are handled as OFF.
	DI	Data input	On/off	With a rising edge in the execution input, the on/off state of the data input is stored in the LSB (least significant bit) or MSB (most significant bit) of the shift registers. Unconnected inputs are handled as OFF.
	DIR	Direction input	On/off	When the direction input is off, the bits are shifted in ascending order. When the direction input is on, the bits are shifted in descending order. Unconnected inputs are handled as OFF.
Output	OUT	Output	–	Output the state of the bit shifted out.
Parameters	R	Start shift register	R0 to R127	The start shift register of the bits to be shifted.
	N	Number of constituent bits	1 to 128	The number of shift registers to be shifted. Specify a constant value.

*1 B0 to B199 for the 12-I/O type.

10: THE SHIFT REGISTER FB

Valid Devices

Parameter	Function	I	Q	M	R	T	TC	TP	C	CC	CP	B	D	AI	Constant
TRG	Execution input	X	X	X	X	X	-	-	X	-	-	X	-	-	-
RST	Reset input	X	X	X	X	X	-	-	X	-	-	X	-	-	-
DI	Data input	X	X	X	X	X	-	-	X	-	-	X	-	-	-
DIR	Direction input	X	X	X	X	X	-	-	X	-	-	X	-	-	-
R	Start shift register	-	-	-	X	-	-	-	-	-	-	-	-	-	-
N	Number of constituent bits	-	-	-	-	-	-	-	-	-	-	-	-	-	X

Operation Example

Example 1

When the direction input (DIR) is off and the execution input (TRG) is turned on, the shift registers, as many as the number of constituent bits starting with the specified shift register, are shifted by 1 bit in ascending order. The state of the data input (DI) is stored in the LSB (least significant bit) of the shift registers.

Output (OUT) is the state of the bit shifted out.

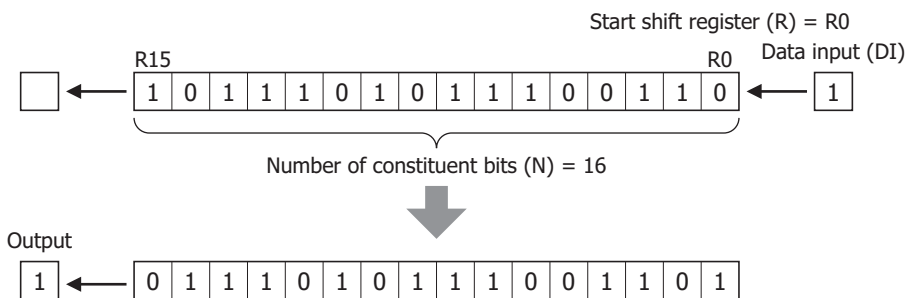

Example 2

When the direction input (DIR) is on and the execution input (TRG) is turned on, the shift registers, as many as the number of constituent bits starting with the specified shift register, are shifted by 1 bit in descending order. The state of the data input (DI) is stored in the MSB (most significant bit) of the shift registers.

Output (OUT) is the state of the bit shifted out.

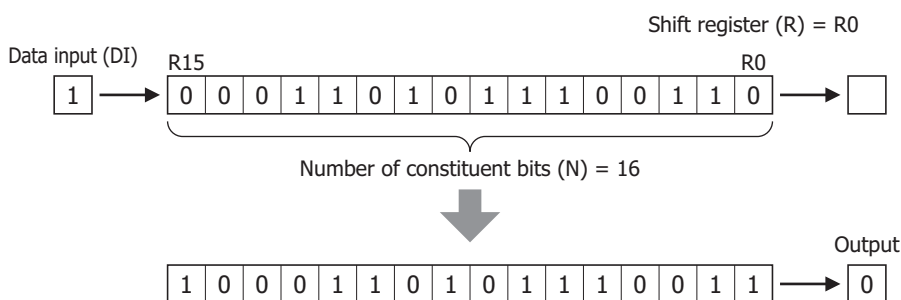

Notes:

- When one of the following conditions is met, a user program execution error occurs and the output is turned off.
 - The number of constituent bits exceeds the range
 - Shift registers specified with the start register and the number of the constituent bits does not exist.
- For user program execution errors, see Chapter 14 "Troubleshooting" - "Errors" - "User Program Execution Errors" in the SmartAXIS Pro/Lite User's Manual.

11: THE COMPARISON FB

The comparison FB compares device values, analog values, or constants, and outputs the comparison result.

CMP (Data Comparison)

Compares comparison value 1 and comparison value 2 and turns the output on or off according to the comparison result.

Symbol

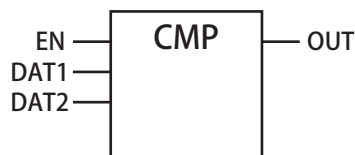

Operation

When the execution input (EN) is on, comparison value 1 (DAT1) and comparison value 2 (DAT2) are compared according to the specified operator, and the comparison result is output. When the execution input is off, the output is turned off.

Applicable SmartAXIS

FT1A-12	FT1A-24	FT1A-40	FT1A-48	FT1A Touch
X	X	X	X	X

Parameters

Parameter	Function	Range	Description
Number	B	Block number	B0 to B999 *1
Input	EN	Execution input	On/off
	DAT1	Comparison value 1	*2
	DAT2	Comparison value 2	
Output	OUT	Output	-
Parameters	OP1	Data type	W (word)/ I (integer)/ D (double word)/ L (long)
	OP2	Operator	=, <>, <, >, <=, >=

*1 B0 to B199 for the 12-I/O type.

*2 When the data type is W (word), the value can be specified within the range of 0 to 65,535.

When the data type is I (integer), the value can be specified within the range of -32,768 to 32,767.

When the data type is D (double word), the value can be specified within the range of 0 to 4,294,967,295.

When the data type is L (long), the value can be specified within the range of -2,147,483,648 to 2,147,483,647.

*3 For a constant, specify the value within the valid range of the data type.

To indirectly specify the value with a device, specify it with the device number where the value is stored, and specify the content of the device within the valid range of the specified data type.

*4 The relationship between the operators and the output is shown in the table on page 11-2.

11: THE COMPARISON FB

Operator	The output is turned on	The output is turned off
=	When comparison value 1 = comparison value 2	When comparison value 1 ≠ comparison value 2
<>	When comparison value 1 ≠ comparison value 2	When comparison value 1 = comparison value 2
<	When comparison value 1 < comparison value 2	When comparison value 1 ≥ comparison value 2
>	When comparison value 1 > comparison value 2	When comparison value 1 ≤ comparison value 2
<=	When comparison value 1 ≤ comparison value 2	When comparison value 1 > comparison value 2
>=	When comparison value 1 ≥ comparison value 2	When comparison value 1 < comparison value 2

Valid Devices

Parameter	Function	I	Q	M	R	T	TC	TP	C	CC	CP	B	D	AI	Constant
EN	Execution input	X	X	X	X	X	-	-	X	-	-	X	-	-	-
DAT1	Comparison value 1	-	-	-	-	-	X	X	-	X	X	-	X	X ^{*1}	X
DAT2	Comparison value 2	-	-	-	-	-	X	X	-	X	X	-	X	X ^{*1}	X

*1 For the Pro, Lite and Touch (relay output type), an analog input FB can be specified only when I (integer) is specified as the data type. For the Touch (transistor output type), an analog input FB can be specified only when W (word) or I (integer) is specified as the data type.

STTG (Schmitt Trigger)

Compares the comparison value and the ON threshold/OFF threshold and turns the output on or off according to the comparison result.

Symbol

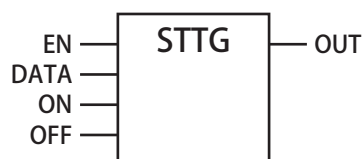

Operation

When the execution input (EN) is on, the comparison value (DATA) is compared with the ON threshold and the OFF threshold, and the output (OUT) is turned on or off.

Applicable SmartAXIS

FT1A-12	FT1A-24	FT1A-40	FT1A-48	FT1A Touch
X	X	X	X	X

Parameters

Parameter	Function	Range	Description	
Number	B	Block number	B0 to B999 * ¹	Unique number to identify each function block. The block number is automatically assigned in ascending order from zero. The block number can be changed to a desired number. However, the block numbers already used in any other FBs cannot be used.
Input	EN	Execution input	On/off	When the execution input is on, the comparison value is compared with the ON threshold and the OFF threshold.
	DATA	Comparison value	* ²	The comparison value. This value can be specified as an analog input, a data register, a timer current value/preset value, a counter current value/preset value, or a constant.* ³ Unconnected inputs are handled as 0.
	ON	ON threshold		The threshold to turn on the output. This value can be specified as an analog input, a data register, a timer current value/preset value, a counter current value/preset value, or a constant.* ³ Unconnected inputs are handled as 0.
	OFF	OFF threshold		The threshold to turn off the output. This value can be specified as an analog input, a data register, a timer current value/preset value, a counter current value/preset value, or a constant.* ³ Unconnected inputs are handled as 0.
Output	OUT	Output	–	When the execution input is on, the comparison value is compared with the ON threshold and the OFF threshold, and the output is turned on or off. When the execution input is off, the output is turned off.
Parameters	OP1	Data type	W (word)/ I (integer)/ D (double word)/ L (long)	Defines the range of the values handled with the comparison value, ON threshold, and OFF threshold. The default is I (integer).

*¹ B0 to B199 for the 12-I/O type.

*² When the data type is W, the value can be specified within the range of 0 to 65,535.

When the data type is I, the value can be specified within the range of -32,768 to 32,767.

When the data type is D, the value can be specified within the range of 0 to 4,294,967,295.

When the data type is L, the value can be specified within the range of -2,147,483,648 to 2,147,483,647.

*³ For a constant, specify the value within the valid range of the data type.

To indirectly specify the value with a device, specify it with the device number where the value is stored, and specify the content of the device within the valid range of the specified data type.

11: THE COMPARISON FB

Valid Devices

Parameter	Function	I	Q	M	R	T	TC	TP	C	CC	CP	B	D	AI	Constant
EN	Execution input	X	X	X	X	X	-	-	X	-	-	X	-	-	-
DATA	Comparison value	-	-	-	-	-	X	X	-	X	X	-	X	X ^{*1}	X
ON	ON threshold	-	-	-	-	-	X	X	-	X	X	-	X	X ^{*1}	X
OFF	OFF threshold	-	-	-	-	-	X	X	-	X	X	-	X	X ^{*1}	X

*1 For the Pro, Lite and Touch (relay output type), an analog input FB can be specified only when I (integer) is specified as the data type. For the Touch (transistor output type), an analog input FB can be specified only when W (word) or I (integer) is specified as the data type.

Timing Chart

(1) When ON threshold \geq OFF threshold

When the execution input (EN) is on, the comparison value (DATA) is compared with the ON threshold (ON) and the OFF threshold, and the output (OUT) is turned on or off.

- When comparison value $>$ ON threshold, the output is turned on.
- When comparison value \leq OFF threshold, the output is turned off.

When the execution input is off, the output is turned off.

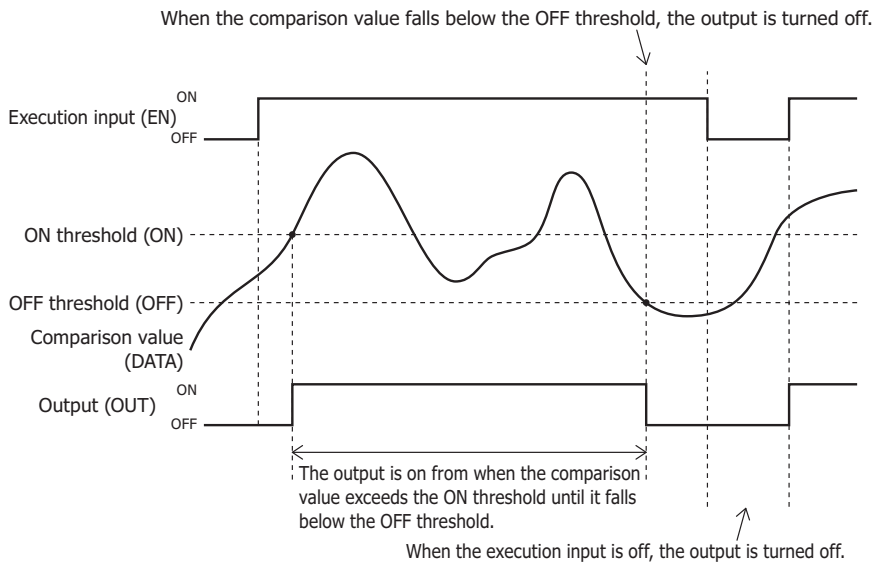

(2) When ON threshold $<$ OFF threshold

When the execution input (EN) is on, the comparison value (DATA) is compared with the ON threshold (ON) and the OFF threshold, and the output (OUT) is turned on or off.

- When OFF threshold \geq comparison value \geq ON threshold, the output is turned on.
- When comparison value $>$ OFF threshold or ON threshold $>$ comparison value, the output is turned off.

When the execution input is off, the output is turned off.

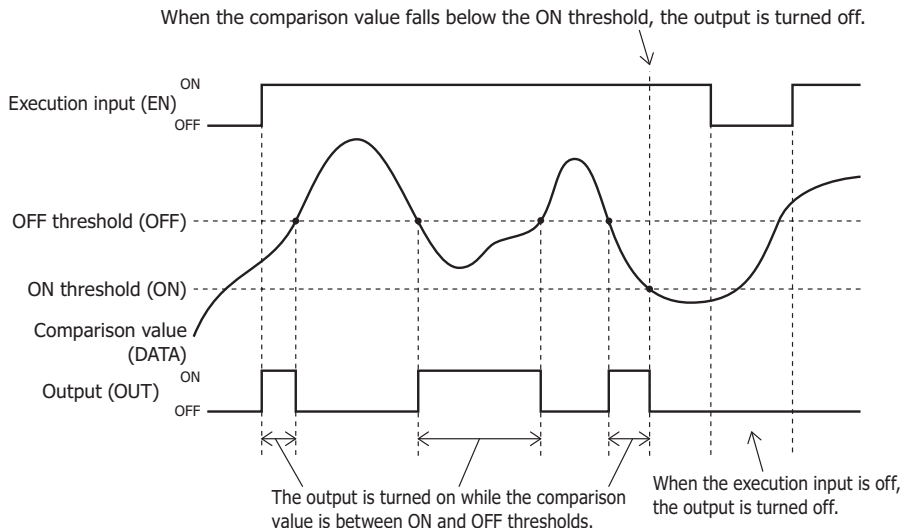

RCMP (Range Comparison)

Compares the comparison value and the upper limit/lower limit and turns the output on or off according to the comparison result.

Symbol

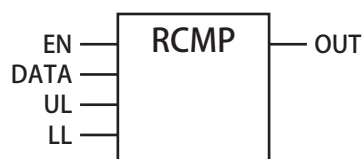

Operation

When the execution input (EN) is on, the output (OUT) is turned on when the comparison value (DATA) is smaller than the lower limit (LL) or when the comparison value is greater than the upper limit (UL). The output is turned off when the comparison value is between the lower limit and the upper limit.

When the execution input is off, the output is turned off.

Applicable SmartAXIS

FT1A-12	FT1A-24	FT1A-40	FT1A-48	FT1A Touch
X	X	X	X	X

Parameters

Parameter	Function	Range	Description	
Number	B	Block number	B0 to B999 * ¹	Unique number to identify special function block. The block number is automatically assigned in ascending order from zero. The block number can be changed to a desired number. However, the block numbers already used in any other FBs cannot be used.
Input	EN	Execution input	On/off	When the execution input is on, the comparison value is compared with the lower/upper limits, and the output is turned on or off. When the execution input is off, the output is turned off.
	DATA	Comparison value	* ²	The comparison value. This value can be specified as an analog input, a data register, a timer current value/preset value, a counter current value/preset value, or a constant.* ³ Unconnected inputs are handled as 0.
	UL	Upper limit		The upper limit value. This value can be specified as an analog input, a data register, a timer current value/preset value, a counter current value/preset value, or a constant.* ³ Unconnected inputs are handled as 0.
	LL	Lower limit		The lower limit value. This value can be specified as an analog input, a data register, a timer current value/preset value, a counter current value/preset value, or a constant.* ³ Unconnected inputs are handled as 0.
Output	OUT	Output	-	When the execution input is on, the output is turned on/off as described below. (1) When comparison value < lower limit or comparison value > upper limit, the output is turned on. (2) When lower limit ≤ comparison value ≤ upper limit, the output is turned off. When the execution input is off, the output is off.
Parameters	OP	Data type	W (word)/ I (integer)/ D (double word)/ L (long)	Defines the range or the values handled with the comparison value, lower limit, and upper limit. The default is I (integer).

*¹ B0 to B199 for the 12-I/O type.

*² When the data type is W, the value can be specified within the range of 0 to 65,535.

When the data type is I, the value can be specified within the range of -32,768 to 32,767.

When the data type is D, the value can be specified within the range of 0 to 4,294,967,295.

When the data type is L, the value can be specified within the range of -2,147,483,648 to 2,147,483,647.

*³ For a constant, specify the value within the valid range of the data type.

To indirectly specify the value with a device, specify it with the device number where the value is stored, and specify the content of the device within the valid range of the specified data type.

11: THE COMPARISON FB

Valid Devices

Parameter	Function	I	Q	M	R	T	TC	TP	C	CC	CP	B	D	AI	Constant
EN	Execution input	X	X	X	X	X	-	-	X	-	-	X	-	-	-
DATA	Comparison value	-	-	-	-	-	X	X	-	X	X	-	X	X ^{*1}	X
LL	Upper limit	-	-	-	-	-	X	X	-	X	X	-	X	X ^{*1}	X
UL	Lower limit	-	-	-	-	-	X	X	-	X	X	-	X	X ^{*1}	X

*1 For the Pro, Lite and Touch (relay output type), an analog input FB can be specified only when I (integer) is specified as the data type. For the Touch (transistor output type), an analog input FB can be specified only when W (word) or I (integer) is specified as the data type.

Timing Chart

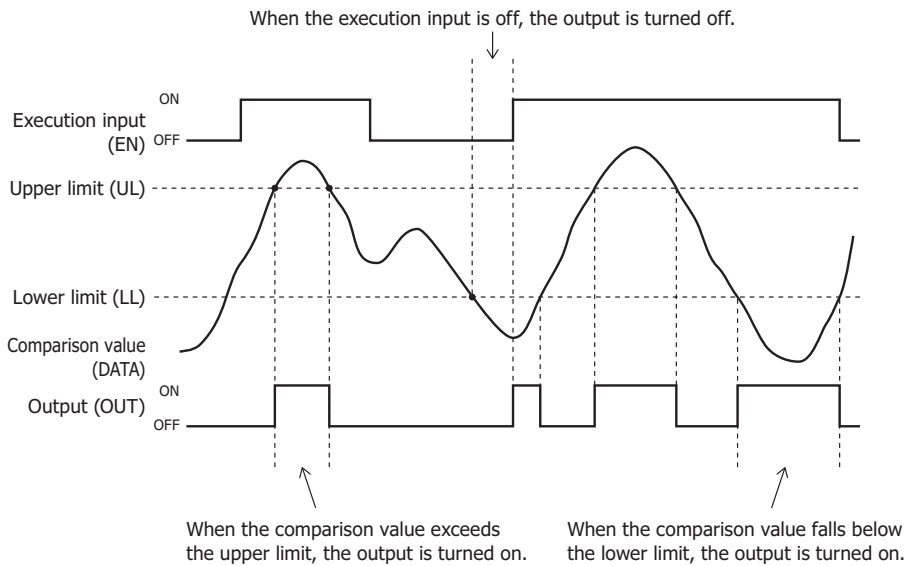

When the execution input (EN) is on, the output (OUT) is turned on/off as described below.

- (1) When the comparison value (DATA) is less than the lower limit, the output is turned on.
- (2) When the comparison value is greater than the upper limit, the output is turned on.
- (3) When the comparison value is between the lower limit and upper limit, the output is turned off.

When the execution input is off, the output is turned off.

The upper limit and lower limit must be properly configured so that the upper limit (UL) is always greater than the lower limit (LL).

Note: When the upper limit (UL) is less than or equal to the lower limit (LL), a user program execution error occurs and the output is turned off. For user program execution errors, see Chapter 14 "User Program Execution Errors" in the SmartAXIS Pro/Lite User's Manual.

12: THE DATA CONVERSION FB

The data conversion FB converts the data stored in devices.

ALT (Alternate Output)

Sets/resets the output.

Symbol

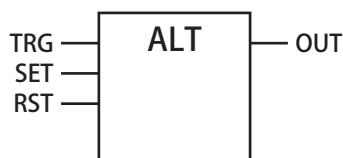

Operation

While the set input (SET) and the reset input (RST) are off, the on/off state of the output is inverted at every rising edge in the execution input (TRG). When the set input is on, the output is set. When the reset input is on, the output is reset. When the set input and the reset input are both on, the output is set/reset according to the operation mode.

Applicable SmartAXIS

FT1A-12	FT1A-24	FT1A-40	FT1A-48	FT1A Touch
X	X	X	X	X

Parameters

Parameter	Function	Range	Description
Number	B	Block number	B0 to B999 *1
Input	TRG	Execution input	On/off
	SET	Set input	On/off
	RST	Reset input	On/off
Output	OUT	Output	–
Parameters	OP	Operation mode	Reset input precedence/ set input precedence
			<p>Unique number to identify each function block. The block number is automatically assigned in ascending order from zero. The block number can be changed to a desired number. However, the block numbers already used in any other FBs cannot be used.</p> <p>At a rising edge in the execution input, the on/off state of the output is inverted.</p> <p>When the set input is on, the output is set.</p> <p>When the reset input is on, the output is reset.</p> <p>When the set input, the reset input, and the output are off, the output is set at a rising edge in the execution input, and the output is reset at another rising edge in the execution input.</p> <p>When the set input and the reset input are on, the output is set/reset according to the operation mode.</p> <p>The input precedence order when the set input and the reset input are simultaneously on can be specified.</p> <p>Set input precedence: The set input is executed with a higher precedence than the reset input.</p> <p>Reset input precedence: The reset input is executed with a higher precedence than the set input.</p> <p>The default is reset input precedence.</p>

*1 B0 to B199 for the 12-I/O type.

Valid Devices

Parameter	Function	I	Q	M	R	T	TC	TP	C	CC	CP	B	D	AI	Constant
TRG	Execution input	X	X	X	X	X	–	–	X	–	–	X	–	–	–
SET	Set input	X	X	X	X	X	–	–	X	–	–	X	–	–	–
RST	Reset input	X	X	X	X	X	–	–	X	–	–	X	–	–	–

Timing Chart

(1) Reset input precedence

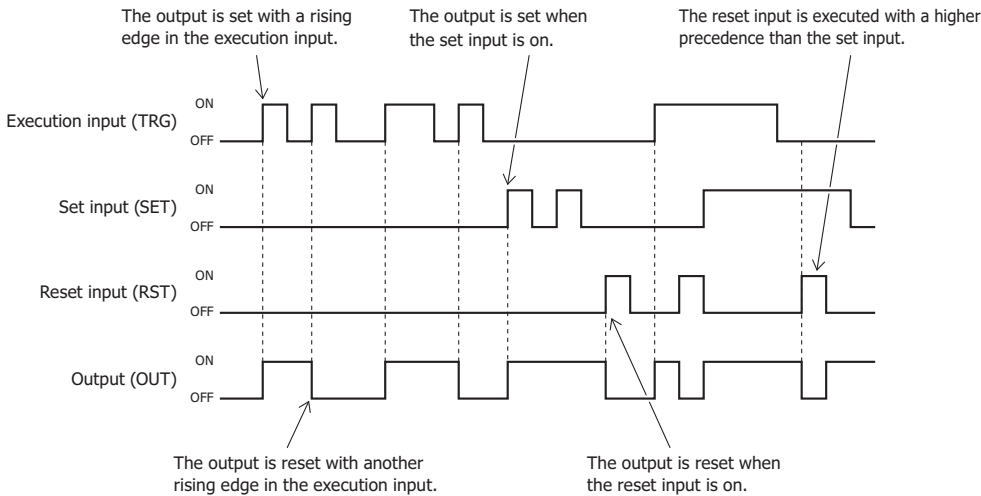

(2) Set input precedence

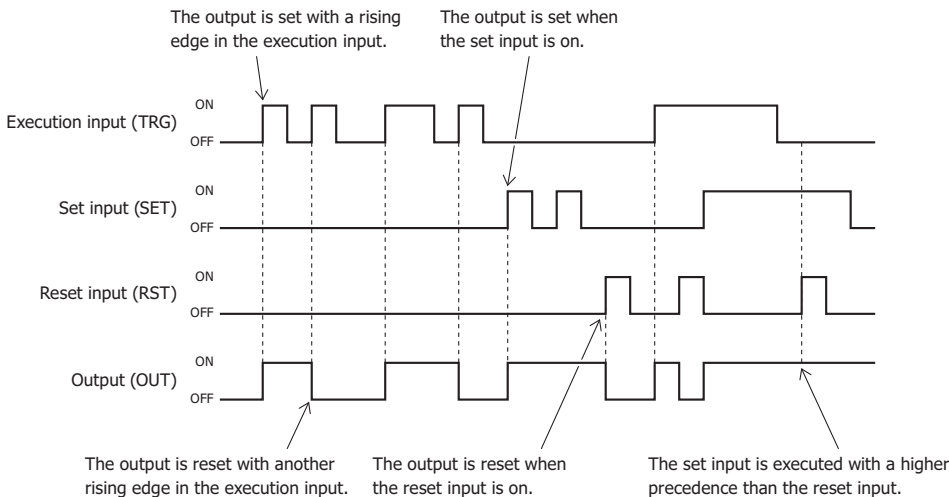

When the set input (SET) and the reset input (RST) are off, the on/off state of the output is inverted at every rising edge in the execution input (EN). The output is also set/reset by the set input/reset input according to the operation mode.

(1) Reset input precedence

Set input	Reset input	Output	Description
0	0	-	The output does not change.
0	1	0	The output is reset.
1	0	1	The output is set.
1	1	0	The output is reset (the reset input is executed with a higher precedence than the set input).

(2) Set input precedence

Set input	Reset input	Output	Description
0	0	-	The output does not change.
0	1	0	The output is reset.
1	0	1	The output is set.
1	1	1	The output is set (the set input is executed with a higher precedence than the reset input).

13: THE WEEK PROGRAMMER FB

The week programmer function blocks turn the output on or off on a specified dates.

WEEK (Weekly Timer)

Compares the specified day of the week, ON time, and OFF time with the current time and outputs that result.

Symbol

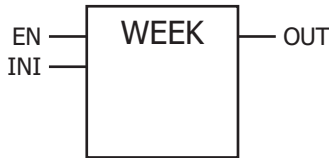

Operation

While the execution input (EN) is on, the output (OUT) is turned on when the current day of the week and time reaches the day of the week and the time specified by the ON settings. The output (OUT) is turned off when the current day of the week and time reaches the day of the week and the time specified by the OFF settings.

For example, if pulse output is disabled and the ON settings are Monday 13:00 and the OFF settings are Wednesday 18:00, output D1 turns on and off as follows.

When the WEEK FB execution input is ON on Monday 13:00, output D1 turns ON on Monday 13:00 and it turns OFF on Wednesday 18:00.

(In this diagram the WEEK FB execution input is turned on at 0:00 on Monday)

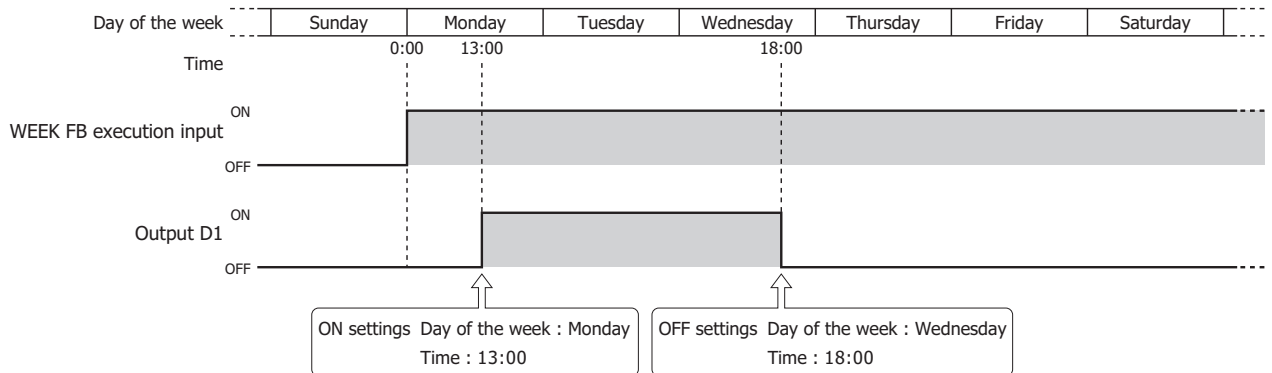

During the period from Monday 13:00 to Wednesday 18:00, when the WEEK FB execution input changes from OFF to ON, output D1 turns ON and it turns OFF on Wednesday 18:00. (In this diagram the WEEK FB execution input is turned on at 6:00 on Tuesday)

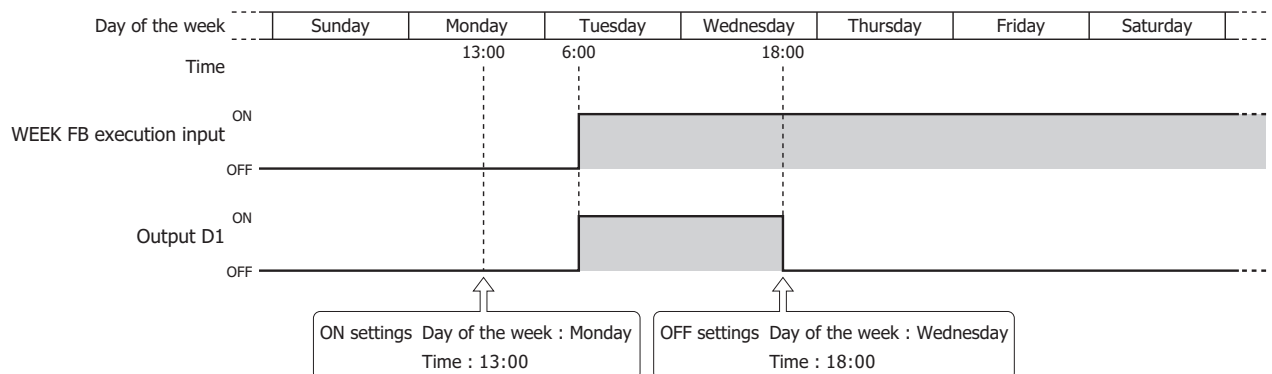

13: THE WEEK PROGRAMMER FB

For example, if pulse output is enabled and the ON settings are Sunday 0:00, output D1 turns on and off as follows. When the WEEK FB execution input turns ON on Sunday 0:00, output D1 turns ON on Sunday 0:00 for only one scan. (In this diagram the WEEK FB execution input is turned on at 6:00 on Saturday)

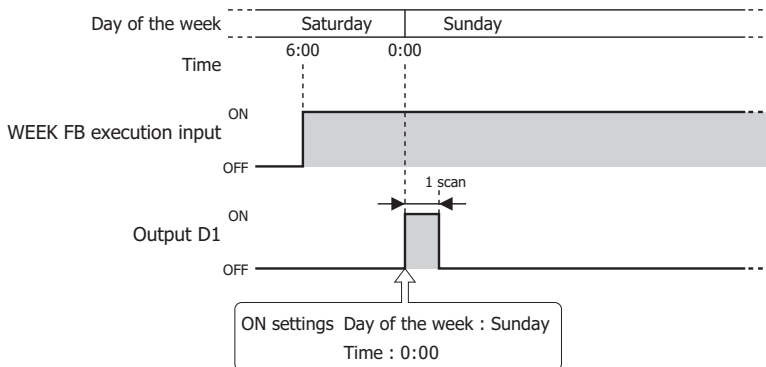

During the period from Sunday 0:00:00 to 0:00:59, when the WEEK FB execution input changes from OFF to ON, output D1 turns ON for only one scan. (In this diagram the WEEK FB execution input is turned on at 0:00:30 on Sunday)

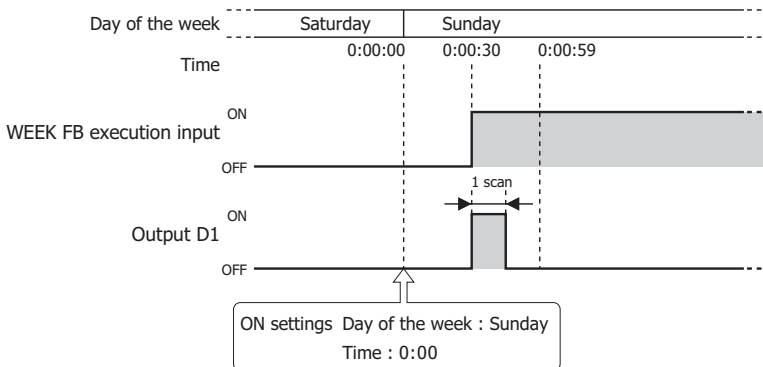

During the period from Sunday 0:01:00 to Saturday 23:59:59, output D1 is OFF.

Notes:

- A maximum of 10 WEEK FB can be used in a user program.
- Normally the output is only updated when the current time reaches the ON/OFF settings time, but when the WEEK FB execution input turns from off to on, the output state at the current time is updated according to the ON/OFF settings.
- When pulse output is enabled, the output is turned on for one scan at the ON settings time. When the WEEK FB execution input turns from off to on, according to the comparison of the current day of the week and time with ON setting, the output is turned on for one scan. For pulse output, see "5. Pulse Output" on page 13-5 or 13-8.
- When the ON time is set to a value larger than 2359, when the OFF time is set to a value larger than 2400, or when the last two digits of the ON time/OFF time are set to a value larger than 59, a user program execution error will occur.
- When the day of the week is not specified, a user program execution error will occur.
- For user program execution errors, see "User Program Execution Error" in the SmartAXIS Pro/Lite User's Manual.

Applicable SmartAXIS

FT1A-12	FT1A-24	FT1A-40	FT1A-48	FT1A Touch
X	X	X	X	X

Parameters

Parameter		Function	Range	Description
Number	B	Block number	B0 to B999 *1	Block number of the function block. The block number is automatically assigned in order from 0, but it can also be changed to the desired number. However, overlapping block numbers used in any other function blocks cannot be used.
	EN	Execution input	On/off	When the execution input turns on, the WEEK FB operates. When the execution input is off, the WEEK FB does not operate and the output is off.
Input	INI	Initialization input	On/off	When configuring the day of week or time by specifying data registers, the values configured in the WindLDR edit dialog box, on the Parameter tab, are stored in the data registers when the initialization input turns on. The initialization input is only used for indirect designation of the WEEK FB settings with data registers.
	OUT	Output	–	Outputs the results according to the comparison of the current day of the week and time with the configured day of the week and time.
Parameters	–	Data registers setting	Enabled/Disabled	Select constant settings or indirect designation with data registers for the WEEK FB day of the week and time configuration. If the data registers setting is disabled, constant setting is selected.
	–	Pulse output	Enabled/Disabled	When pulse output is enabled, output is turned on for one scan at the ON settings time. When the execution input turns from off to on, according to the comparison of the current day of the week and time with ON setting, the output is turned on for one scan. When pulse output is disabled, the output turns on or off according to the ON settings and OFF settings.
	S1	Starting data register	D0000 to D0997, D1000 to D1997 (Depends on the number of parameter tabs*2 *3)	Specify the start of the data register area to store the days of the week and time settings for the WEEK FB. Starting from the specified data register, "3 x N (N: number of parameter tabs)" consecutive data registers are allocated. Specify only when indirect designation of the WEEK FB settings with data register is selected.
	S2	Number of parameter tabs	1 to 20	Specify the number of parameter tabs.

*1 B0 to B199 can be used for the 12 I/O type.

*2 D0000 to D0397 can be used for the 12 I/O type.

*3 A range that spans D0999 and D1000 cannot be set.

Valid Devices

Parameter	Function	I	Q	M	R	T	TC	TP	C	CC	CP	B	D	AI	Constant
EN	Execution input	X	X	X	X	X	–	–	X	–	–	X	–	–	–
INI	Initialization input	X	–	X	–	–	–	–	–	–	–	X	–	–	–
S1	Starting data register	–	–	–	–	–	–	–	–	–	–	–	X*1	–	–
S2	Number of parameter tabs	–	–	–	–	–	–	–	–	–	–	–	–	–	X

*1 Special data registers cannot be used.

Settings

There are two methods to configure the day of the week and the time for the WEEK FB. Specify the method on the Device tab with Data register settings.

- Configuring the day of the week and the time as constant settings

The day of the week and the time for the ON/OFF settings are uniquely determined. The day of the week and the time for the ON/OFF settings cannot be changed while the SmartAXIS is running.

For details, see "Configuring the day of the week and the time as constant settings" on page 13-4.

- Configuring the day of the week and the time by specifying data registers

The day of the week and the time for the ON/OFF settings are configured according to the values stored in the specified data registers.

The day of the week and the time for the ON/OFF settings can be changed while the SmartAXIS is running.

For details, see "Configuring the days of the week and the time by specifying data registers" on page 13-7.

Configuring the day of the week and the time as constant settings

The day of the week and the time for the ON/OFF settings are uniquely determined. The day of the week and the time for the ON/OFF settings cannot be changed while the SmartAXIS is running.

■ Device tab

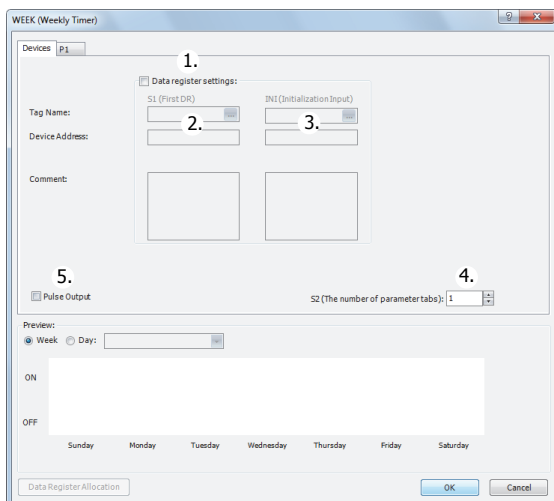

1. Data register settings

Select constant setting or indirect designation with data registers for the WEEK FB day of the week and time configuration.

To configure the day of the week and the time as constant settings, clear this check box.

Cleared check box

The day of the week and time are configured permanently.

The day of the week and the time are configured on the parameter tabs. The day of the week and the time cannot be changed while the SmartAXIS is running.

For the settings, see "Parameter tab" on page 13-5.

Note: When this check box is selected, the settings for the day of the week and the time are indirectly specified with data registers.

Configure the day of the week and the time by using data registers. In this case, the day of the week and the time can be changed while the SmartAXIS is running.

For indirect designation with data registers, see "Configuring the days of the week and the time by specifying data registers" on page 13-7.

2. S1: First Data Register

This setting is not configured when configuring the day of the week and the time as constant settings.

3. INI: Initialization Input

This setting is not configured when configuring the day of the week and the time as constant settings.

4. S2: The number of parameter tabs

Specify the number of parameter tabs. When this value is increased or decreased, the number of parameter tabs appearing on the dialog box increases or decreases. 6 bytes of the user program area are used for each parameter tab.

For the settings, see "Parameter tab" on page 13-5.

5. Pulse Output

Select the operation for the WEEK FB output (OUT). This setting is applied to all parameter tabs.

Selected check box

When the current day of the week and the time reaches the day of the week and the time configured in the ON settings, the output is turned on for only one scan.

Cleared check box

The output is turned on or off according to the ON settings and the OFF settings.

Parameter tab

This tab configures the ON/OFF settings for the output. A maximum of 20 parameter tabs can be configured for 1 WEEK FB.

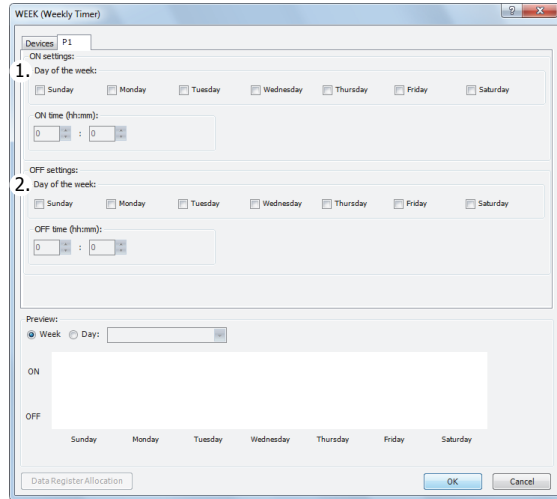

1. ON settings

This section configures the day of the week and the time to turn on the output. The output is turned on at the specified time for the specified day of the week.

Settings	Content	Range
Day of the week	Specifies the days of the week.	-
ON time	Enters the time. Set the time in a range from 00:00 to 23:59.	Hour: 0 to 23
		Minute: 0 to 59

2. OFF settings

This section configures the day of the week and the time to turn off the output. The output is turned off at the specified time for the specified day of the week.

Settings	Content	Range
Day of the week	Specifies the days of the week.	-
OFF time	Enters the time. Set the time in a range from 00:00 to 24:00.	Hour: 0 to 24
		Minute: 0 to 59

Notes:

- When the time is duplicated in the settings on other tabs, the settings on the tab with the larger tab number are valid. For example, if ON time is 8:00 and OFF time is 9:00 on the P 1 tab and ON time is 9:00 and OFF time is 10:00 on the P 2 tab, the 9:00 setting is duplicated on the 2 tabs and OFF time for the P 1 tab is disabled. In this situation, the output is on from 8:00 to 10:00.

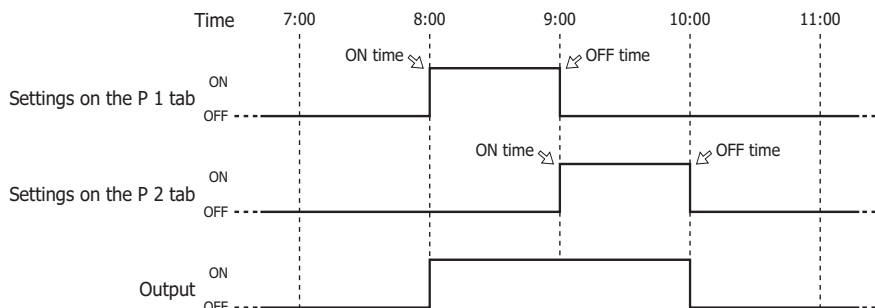

- If ON time is 9:00 and OFF time is 10:00 on the P 1 tab and ON time is 8:00 and OFF time is 9:00 on the P 2 tab, the 9:00 setting is duplicated on the 2 tabs and ON time for the P 1 tab is disabled. In this situation, the output is on from 8:00 to 9:00.

■ Preview

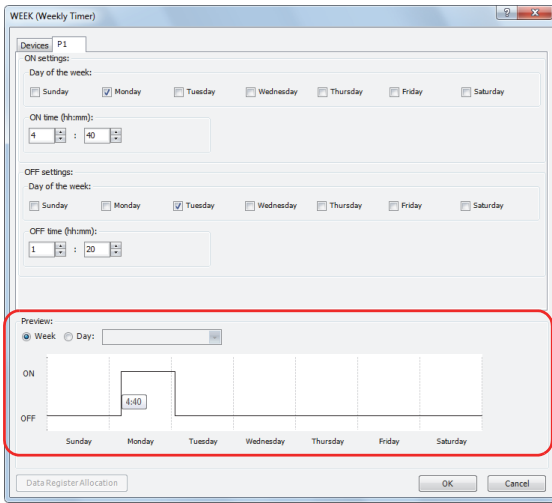

The preview shows the ON/OFF state for the output based on the settings configured on the parameter tabs as a time chart. The preview can be shown as a week or a day.

Settings	Content
Week	Select Week when showing the preview as a week.
Day	Select Day when showing the preview as a day.

Configuring the days of the week and the time by specifying data registers

The day of the week and the time for the ON/OFF settings are configured according to the values stored in the specified data registers.

The day of the week and the time for the ON/OFF settings can be changed while the SmartAXIS is running.

When the day of the week or the time in the ON/OFF settings is changed while the WEEK FB execution is turned on, the changed data register values are reflected when the current date and time reaches the day of the week and the time specified by the ON/OFF settings.

■ Device tab

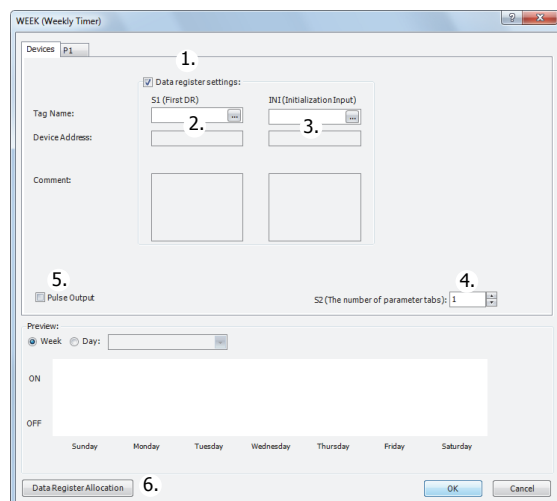

1. Data register settings

Select constant setting or indirect designation with data registers for the WEEK FB day of the week and the time configuration. To configure the day of the week and the time by specifying data registers, select this check box.

Selected check box

The day of the week and the time settings are indirectly specified by data registers.

Configure the day of the week and the time by using data registers. The day of the week and the time can be changed while the SmartAXIS is running.

For allocating the data register area, see "Data Register Allocation" on page 13-9.

The data registers can be initialized with the days of the week and the times configured on the parameter tabs by turning on the initialization input.

For initialization, see "3. INI: Initialization Input".

Note: When this check box is cleared, the day of the week and the time are constant settings.

The day of the week and the time are configured on the parameter tabs. In this case, the day of the week and the time cannot be changed while the SmartAXIS is running.

For constant settings, see "Configuring the day of the week and the time as constant settings" on page 13-4.

2. S1: First Data Register

Specify the start of the data register area to store the days of the week and time settings for the WEEK FB.

This setting is only used when indirectly specifying the settings for the WEEK FB with data registers.

Settings	Content
Tag Name	Specify the tag name or the device address for the device.
Device Address	Shows the device address that corresponds to the tag name.
Used data registers	Shows the range of data registers used to store the settings. This item changes when the device address or the number of parameter tabs changes.
Comment	Shows the comment for the device address. This item can be edited.

For allocating the data register area, see "Parameter tab" on page 13-8.

3. INI: Initialization Input

Specify the device to initialize the days of the week and the times stored in the data register area that starts from S1 (source 1).

The values configured on the parameter tabs are stored in the data registers when the initialization input is turned on.

This setting is only used when indirectly specifying the settings for the WEEK FB with data registers.

4. S2: The number of parameter tabs

Specify the number of parameter tabs.

This setting is shared in common with "Configuring the day of the week and the time as constant settings" on page 13-4. See "4.

S2: The number of parameter tabs" on page 13-4.

5. Pulse Output

Select the operation for the WEEK FB output (OUT). This setting is applied to all parameter tabs.

This setting is shared in common with "Configuring the day of the week and the time as constant settings" on page 13-4. See "5. Pulse Output" on page 13-5.

6. Data Register Allocation

Click this button to display the Data Register Allocation dialog box. As shown below, a table of the data registers and their corresponding WEEK FB settings is displayed in the dialog box (7). Click **Allocate Comments** (8) and you can set each name of the settings (each contents) to the comments for the corresponding data registers.

This button is only used when indirectly specifying the settings for the WEEK FB with data registers.

Data Register Allocation dialog box

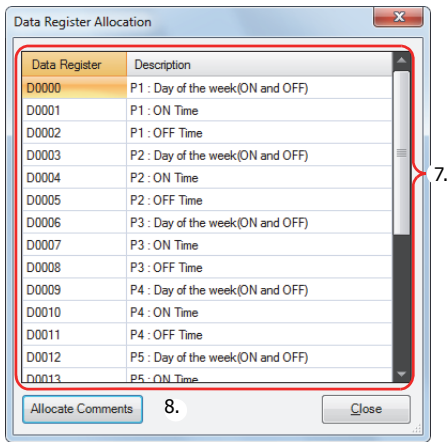

Parameter tab

This tab configures the ON/OFF settings for the output. A maximum of 20 parameter tabs can be configured for 1 WEEK FB.

If indirectly specifying the settings for the WEEK FB with data registers, the values configured on the parameter tabs are stored in the data registers when the initialization input is turned on.

This setting is shared in common with "Configuring the day of the week and the time as constant settings" on page 13-4. See "Parameter tab" on page 13-5.

Preview

The preview shows the ON/OFF state for the output based on the settings configured on the parameter tabs as a time chart.

This function is shared in common with "Configuring the day of the week and the time as constant settings" on page 13-4. See "Preview" on page 13-6.

Data Register Allocation

If indirectly specifying the settings for the WEEK FB with data registers, the settings are allocated to the data registers as follows.

Storage destination	Data size (word)	R (read)/W (write)	Settings
Start address+0	1	R/W	P 1 tab Day of the week ON time OFF time
Start address+1	1	R/W	
Start address+2	1	R/W	
Start address+3	1	R/W	P 2 tab Day of the week ON time OFF time
Start address+4	1	R/W	
Start address+5	1	R/W	
•	•	•	•
•	•	•	•
•	•	•	•
Start address+57	1	R/W	P 20 tab Day of the week ON time OFF time
Start address+58	1	R/W	
Start address+59	1	R/W	

Note: "R/W" is the abbreviation for read/write. When R/W, it can be read and written. When R, it can only be read. When W, it can only be written.

■ **Day of the week allocation in a data register**

The day of the week for the ON settings and the day of the week for the OFF settings are allocated as bits in 1 data register as follows.

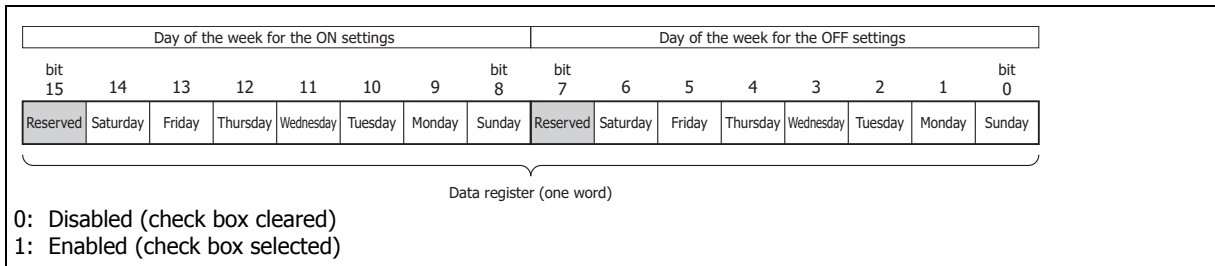

Example day of the week settings

[To configure the output to turn on Monday and to turn off Friday]

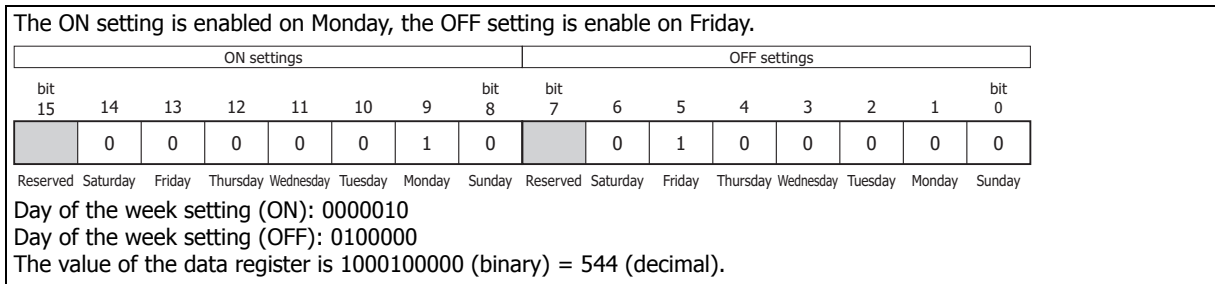

[To configure the output to turn on Monday and Thursday and to turn off Tuesday and Saturday]

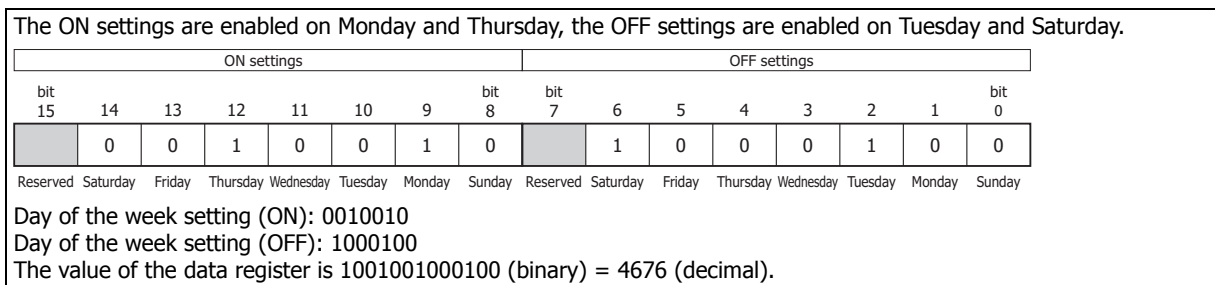

The ON time and the OFF time are stored in each data register as follows.

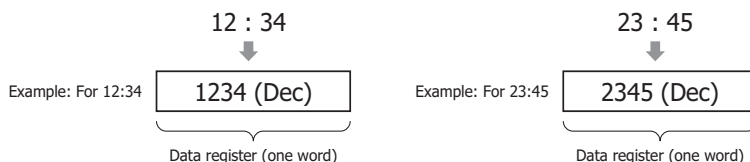

Operation Example

[To turn on output Q0 Monday to Friday each week from 8:30 to 17:15]

Parameter tab

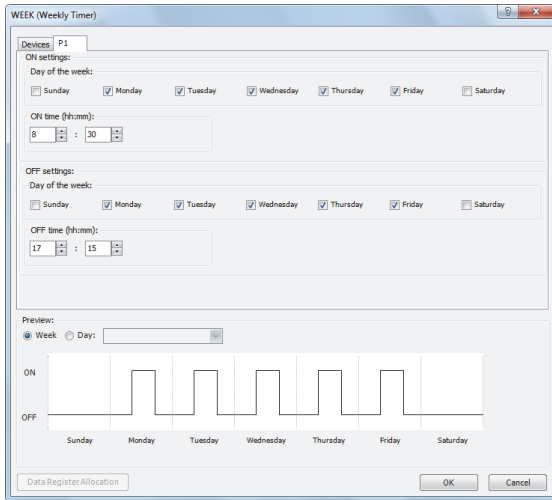

Configure the tabs as shown above and connect the WEEK FB output to Q000.

[To turn on output Q000 Tuesday, Wednesday, and Saturday each week from 20:30 to 1:15 the next day]

Parameter tab

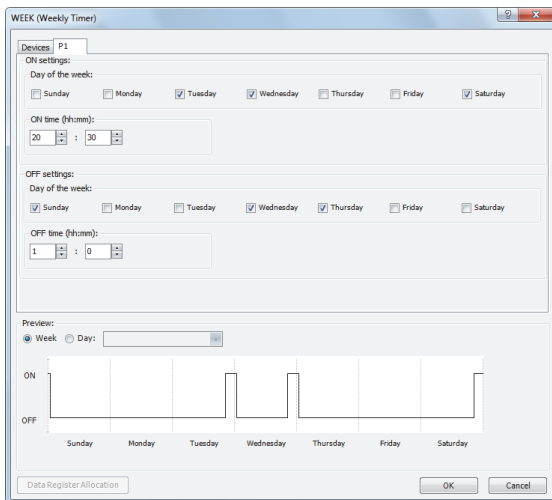

Configure the tabs as shown above and connect the WEEK FB output to Q000.

[To turn on output Q000 Monday, Wednesday, and Friday each week from 6:00 to 9:00, 15:00 to 18:00, and 22:00 to 0:00 the next day]

Parameter tab

Configure the settings using 3 tabs.

On tab 1, configure the output to turn on Monday, Wednesday, and Friday from 6:00 to 9:00.

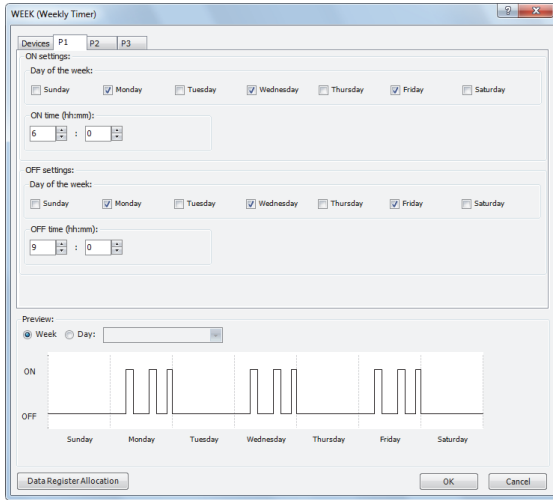

On tab 2, configure the output to turn on Monday, Wednesday, and Friday from 15:00 to 18:00.

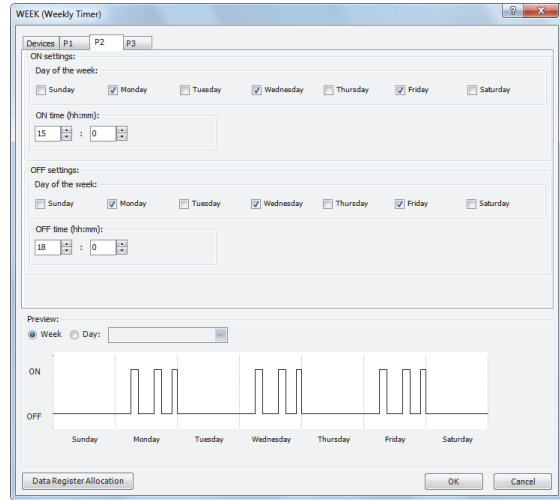

On tab 3, configure the output to turn on Monday, Wednesday, and Friday from 22:00 to 0:00 the next day.

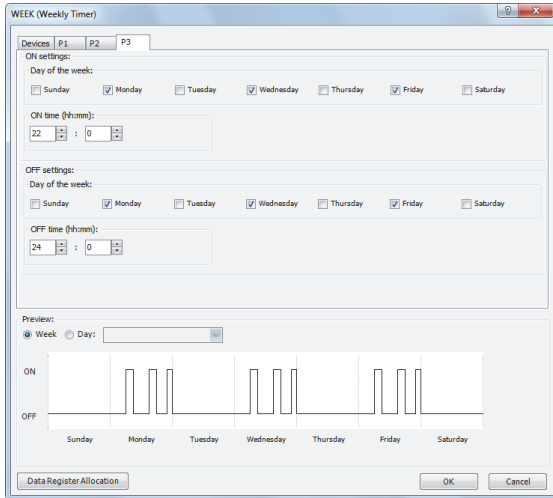

Configure the tabs as shown above and connect the **WEEK FB output** to Q000.

13: THE WEEK PROGRAMMER FB

[To indirectly specify the settings with data registers]

This example describes turning on output Q000 Monday to Friday each week from 8:30 to 17:15 as an example.

Select the Data register settings check box and set S1 to D0000 and INI to M0000.

Device tab

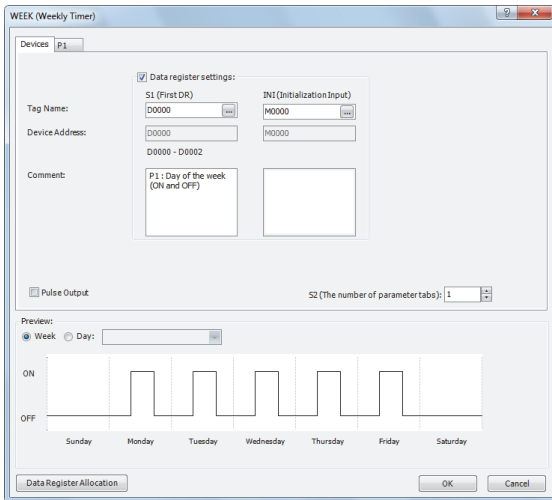

Parameter tab

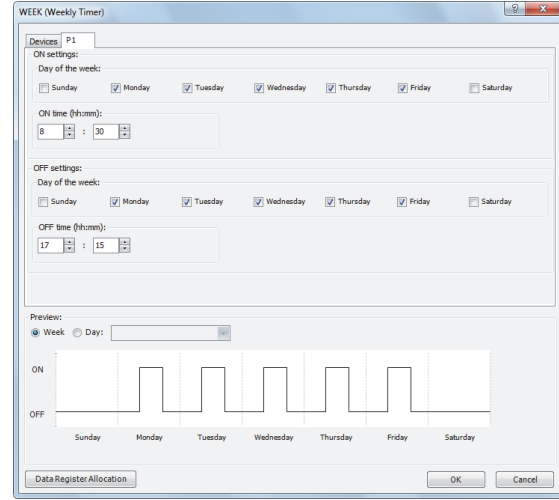

Data Register Allocation

The settings on the P 1 tab are allocated to data registers D0000 to D0002 as shown in the table below. The settings configured on the parameter tab are stored in D0000 to D0002, when the initialization input INI is turned on.

Data Registers	Settings	Initial setting
D0000	P 1 tab	Day of the week setting
D0001		ON time
D0002		OFF time
		15934 (Monday to Friday, both ON settings and OFF settings)
		830
		1715

FBD program

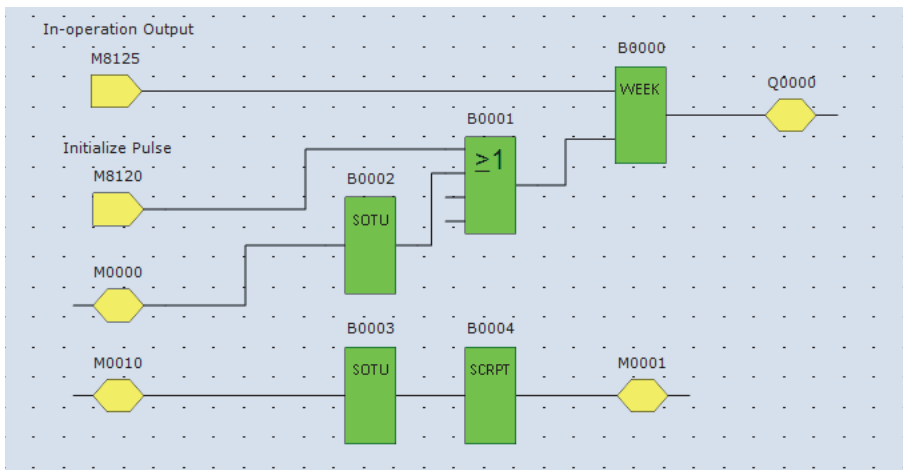

- The initialization input (M0000) turns on with the first scan and the initial settings configured on the P 1 tab are stored in D0000 to D0002.
- The WEEK FB starts operating according to the values of data registers D0000 to D0002.
- When M0010 turns on, the ON time (D0001) changes to 9:00 and the OFF time (D0002) changes to 17:00.
- When M0001 turns on, all of the WEEK FB settings (D0000 to D0002) return to the initial settings.

YEAR (Yearly Timer)

Compares the specified date with the current date and outputs that result. The dates can be specified in a full year.

Symbol

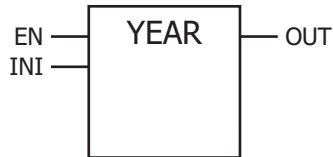

Operation description

While the execution input (EN) is on, the output (OUT) is turned on when the current date reaches the date specified by the ON settings. The output (OUT) is turned off when the current date reaches the date specified by the OFF settings.

For example, when the ON settings are December 15, 2012 and the OFF settings are January 20, 2013, the output (OUT) turns on and off as follows.

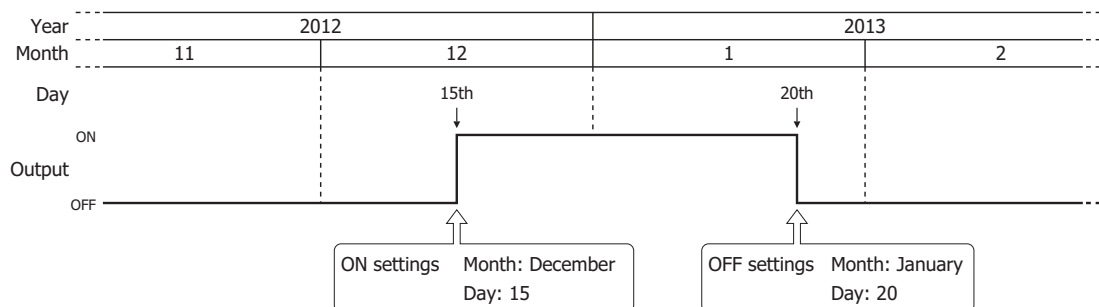

Notes:

- A maximum of 10 YEAR FB can be used in a user program.
- Normally the output is only updated when the current date reaches the ON/OFF settings, but when the YEAR FB execution input turns from off to on, the output state at the current date is updated according to the ON/OFF settings.
For details, see "Timing Chart when the Execution Input Turns On during the Configured Period" on page 13-23.
- When pulse output is enabled, output is turned on for one scan at the instant (0:00) the date changes to the ON settings date.
When the YEAR FB execution input turns on, according to the comparison of the current date with ON settings, the output is turned on for one scan.
For pulse output, see "5. Pulse Output" on page 13-16 or 13-19.
- When the yearly setting and monthly setting are enabled and a date that does not exist depending on the month or year is set for the ON setting or the OFF setting, the output turns on or off on the first day of the following month.
- When the year data is outside the range of 2000 to 2099, the month data is outside the range of 1 to 12, the day data is outside the range of 1 to 31, the week data is outside the range of 1 to 6 (1st week to 5th week, or last week), or the day of the week data is outside the range of 0 to 6, a user program execution error will occur.
- For user program execution errors, see "User Program Execution Error" in the SmartAXIS Pro/Lite User's Manual.

13: THE WEEK PROGRAMMER FB

Applicable SmartAXIS

FT1A-12	FT1A-24	FT1A-40	FT1A-48	FT1A Touch
X	X	X	X	X

Parameters

Parameter		Function	Range	Description
Number	B	Block number	B0 to B999 *1	Block number of the function block. The block number is automatically assigned in order from 0, but it can also be changed to the desired number. However, overlapping block numbers used in any other function blocks cannot be used.
	EN	Execution input	On/off	When the execution input turns on, the YEAR FB operates. When the execution input is off, the YEAR FB does not operate and the output is off.
Input	INI	Initialization input	On/off	When configuring the date by specifying data registers, the values configured in the WindLDR edit dialog box, on the Parameter tab, are stored in the data registers when the initialization input turns on. The initialization input is only used for indirect designation of the YEAR FB settings. with data registers.
	OUT	Output	–	Compares the specified date with the current date and outputs the result.
Parameters	–	Data registers settings	Enabled/Disabled	Select constant settings or indirect designation with data registers for YEAR FB dates configuration. If the data registers setting is disabled, constant setting is selected.
	–	Pulse output	Enabled/Disabled	When pulse output is enabled, output is turned on for one scan at the instant (0:00) the date changes to the ON date. When the execution input turns from off to on, according to the comparison of the current date with ON settings, the output is turned on for one scan. When pulse output is disabled, the output turns on or off according to the ON settings and OFF settings.
	S1	Starting data registers	D0000 to D0996, D1000 to D1996 (Depends on the number of parameter tabs*2 *3)	Specify the start of the data register area to store the dates for the YEAR FB. Starting from the specified data register, "4 x N (N: number of parameter tabs)" consecutive data registers are allocated. Specify only when indirect designation of the YEAR FB settings with data register is selected.
	S2	Number of parameter tabs	1 to 20	Specify the number of parameter tabs.

*1 B0 to B199 can be used for the 12 I/O type.

*2 D0000 to D0396 can be used for the 12 I/O type.

*3 A range that spans D0999 and D1000 cannot be set.

Valid Devices

Parameter	Function	I	Q	M	R	T	TC	TP	C	CC	CP	B	D	AI	Constant
EN	Execution input	X	X	X	X	X	–	–	X	–	–	X	–	–	–
INI	Initialization input	X	–	X	–	–	–	–	–	–	–	X	–	–	–
S1	Starting data register	–	–	–	–	–	–	–	–	–	–	–	X*1	–	–
S2	Number of parameter tabs	–	–	–	–	–	–	–	–	–	–	–	–	–	X

*1 Special data registers cannot be used.

Settings

There are two methods to configure the dates for the YEAR FB. Specify the method on the Device tab with Data register settings.

- Configure the dates as constant setting

The dates for the ON/OFF settings are uniquely determined. The dates for the ON/OFF settings cannot be changed while the SmartAXIS is running.

For details, see "Configuring the dates as constant setting" on page 13-15.
- Configuring the dates by specifying data registers

The dates for the ON/OFF settings are configured according to the values stored in the specified data registers.

The dates for the ON/OFF settings can be changed while the SmartAXIS is running.

For details, see "Configuring the dates by specifying data registers" on page 13-18.

Configuring the dates as constant setting

The dates for the ON/OFF settings are uniquely determined. The dates for the ON/OFF settings cannot be changed while the SmartAXIS is running.

■ Device tab

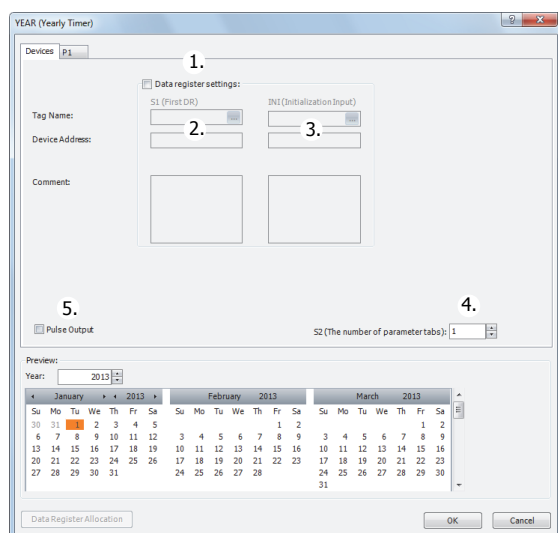

1. Data register settings

Select constant settings or indirect designation with data registers for the YEAR FB date configuration.

To configure the dates as constant settings, clear this check box.

Cleared check box

The dates are configured permanently.

The dates are configured on the parameter tabs. The dates cannot be changed while the SmartAXIS is running.

For the settings, see "Parameter tab" on page 13-16.

Note: When this check box is selected, the settings for dates are indirectly specified with data registers.

Configure the dates by using data registers. In this case, the dates can be changed while the SmartAXIS is running.

For indirect designation with data registers, see "Configuring the dates by specifying data registers" on page 13-18.

2. S1: First Data Register

This setting is not configured when configuring the dates as constant settings.

3. INI: Initialization Input

This setting is not configured when configuring the dates as constant settings.

4. S2: The number of parameter tabs

Specify the number of parameter tabs. When this value is increased or decreased, the number of parameter tabs displayed on the dialog box increases or decreases.

The eight bytes of the user program area are used for each parameter tab.

For the settings, see "Parameter tab" on page 13-16.

5. Pulse Output

Select the operation of the YEAR FB output (OUT). This setting is applied to all parameter tabs.

Selected check box

When the current date reaches to the date in the ON settings, the output is turned on for only one scan.

Cleared check box

The output is turned on or off according to the ON settings and the OFF settings.

■ **Parameter tab**

This tab configures the settings for the output. A maximum of 20 parameter tabs can be configured for 1 YEAR FB.

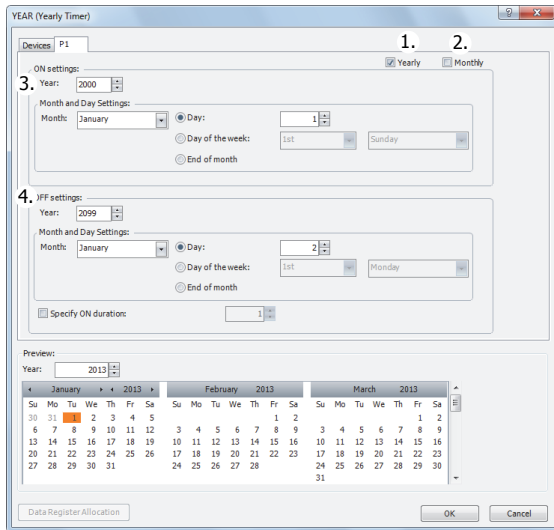

1. Yearly

When Yearly is selected, the Month and Day settings or Specify ON duration are valid every year.

At this time, specify the Year for ON settings as the valid starting year and the Year for OFF settings as the valid ending year.

2. Monthly

In addition to Yearly, when Monthly is selected, Day, Day of the week or Specify ON duration settings are valid every month. Month setting is disabled.

3. ON settings

This section configures the date to turn on the output. The output is turned on at 0:00 on the configured date.

Settings		Content	Range
Year		Specifies the year to turn on the output.	2000 to 2099
Month and Day Settings	Month	Specifies the month to turn on the output.	1 to 12
	Day	Specifies the day to turn on the output.	1 to 31
	Day of the week	Specifies the day as the day of the week to turn on the output. Select in the range of the 1st week to the 5th week or the last week and set the day of the week.	1 to 6, 0 to 6
	End of month	Specify the end of month to turn on the output on the last day of the month.	–

4. OFF settings

This section configures the date to turn off the output. The output is turned off at 0:00 on the configured date.

Settings		Content	Range
Year		Specifies the year to turn off the output.	2000 to 2099
Month and Day Settings	Month	Specifies the month to turn off the output.	1 to 12
	Day	Specifies the day to turn off the output.	1 to 31
	Day of the week	Specifies the day as the day of the week to turn off the output. Select in the range of the 1st week to the 5th week or the last week and set the day of the week.	1 to 6, 0 to 6
	End of month	Specify the end of month to turn off the output on the last day of the month.	–
Specify ON duration		Specify the period for keeping the output on after it turns on. If this setting is enabled, other OFF settings are disabled. Specify in the range of 1 day to 30 days.	1 to 30

Notes:

- When the date is duplicated in the settings on other tabs, the settings on the tab with the larger tab number are valid.
- For example, if the ON date is the 8th of every month and the OFF date is the 16th of every month on the P 1 tab and the ON date is the 16th of every month and the OFF date is the 22nd of every month on the P 2 tab, the 16th of every month setting is duplicated on the 2 tabs and the ON settings for the P 2 tab are valid. In this situation, the output is on from the 8th to the 22nd of every month.

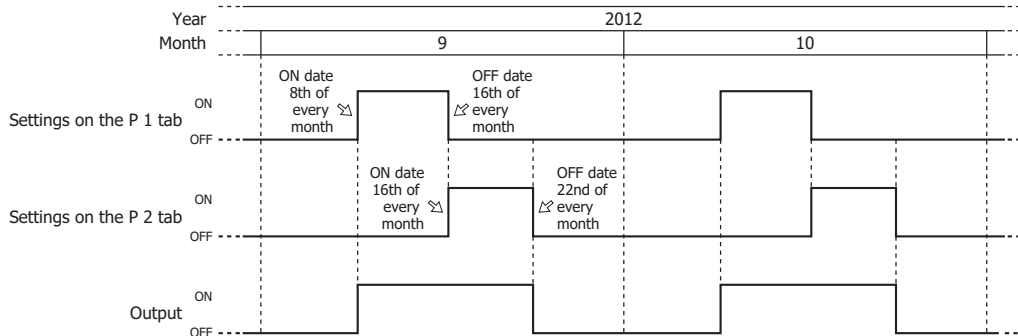

- If the ON date is the 16th of every month and the OFF date is the 22nd of every month on the P 1 tab and the ON date is the 8th of every month and the OFF date is the 16th of every month on the P 2 tab, the 16th of every month setting is duplicated on the 2 tabs and the ON settings for the P 1 tab are disabled. In this situation, the output is on from the 8th to the 16th of every month.

Preview

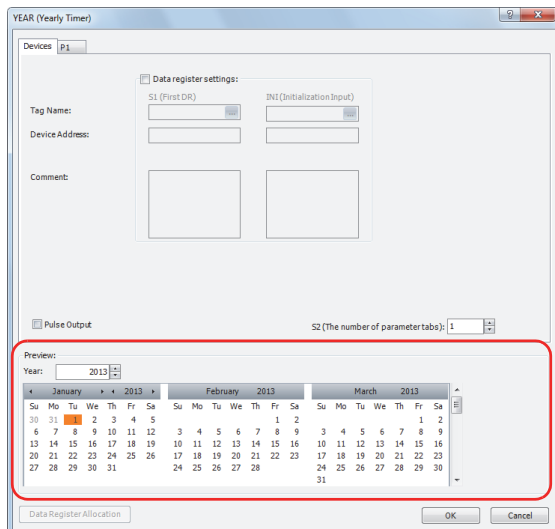

The preview shows the ON/OFF state for the output based on the settings configured on the parameter tabs in a calendar. The dates that are set to ON are highlighted in orange. Three months are shown at one time.

Item	Content
Year	Specifies the year to show in the preview.
Scrollbar	Change the month shown in the preview by moving the scrollbar.

Configuring the dates by specifying data registers

The dates for the ON/OFF settings are configured according to the values stored in the specified data registers. The dates for the ON/OFF settings can be changed while the SmartAXIS is running.

When the date in the ON/OFF settings is changed while the YEAR FB execution input is on, the changed data register values are reflected when the current date and time reaches 0:00 on the date specified by the ON/OFF settings.

■ **Device tab**

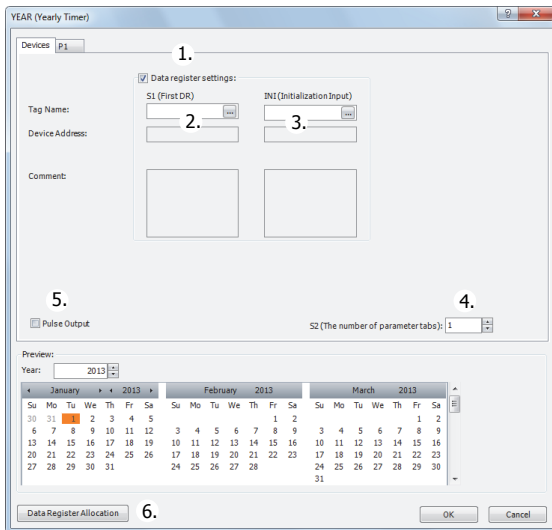

1. Data register settings

Select constant setting or indirect designation with data registers for the YEAR FB date configuration. To configure the dates by specifying data registers, select this check box.

Selected check box

The date settings are indirectly specified by data registers. Configure the dates by using data registers. The dates can be changed while the SmartAXIS is running. For allocating the data register area, see "Data Register Allocation" on page 13-20. The data registers can be initialized with the dates configured on the parameter tabs by turning on the initialization input. For initialization, see "3. INI: Initialization Input".

Note: When this check box is cleared, the dates are constant settings. The dates are configured on the parameter tabs. In this case, the dates cannot be changed while the SmartAXIS is running. For constant settings, see "Configuring the dates as constant setting" on page 13-15.

2. S1: First Data Register

Specify the start of the data register area to store the special dates for the YEAR FB. This setting is only used when indirectly specifying the dates with data registers.

Settings	Content
Tag Name	Specify the tag name or the device address for the device.
Device Address	Shows the device address that corresponds to the tag name.
Used data registers	Shows the range of data registers used to store the settings. This item changes when the device address or the number of parameter tabs changes.
Comment	Shows the comment for the device address. This item can be edited.

For allocating the data register area, see "Data Register Allocation" on page 13-20.

3. INI: Initialization Input

Specify the device to initialize the dates stored in the data register area that starts from S1 (source 1). The values configured on the parameter tabs are stored in the data registers when the initialization input is turned on. This setting is only used when indirectly specifying the settings for the YEAR FB with data registers.

4. S2: The number of parameter tabs

Specify the number of parameter tabs. This setting is shared in common with "Configuring the dates as constant setting" on page 13-15. See "4. S2: The number of parameter tabs" on page 13-15.

5. Pulse Output

Select the operation of the YEAR FB output (OUT). This setting is applied to all parameter tabs.

This setting is shared in common with "Configuring the dates as constant setting" on page 13-15. See "5. Pulse Output" on page 13-16.

6. Data Register Allocation

Click this button to display the Data Register Allocation dialog box. As shown below, a table of the data registers and their corresponding YEAR FB settings is displayed in the dialog box (7). Click **Allocate Comments** (8) and you can set each name of the settings (each content) to the comments for the corresponding data registers.

This button is only used when indirectly specifying the settings for the YEAR FB with data registers.

Data Register Allocation dialog box

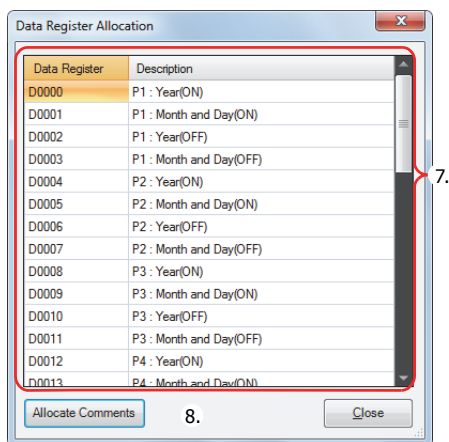

■ Parameter tab

This tab configures the settings for the output. A maximum of 20 parameter tabs can be configured for 1 YEAR FB.

If indirectly specifying the settings for the YEAR FB with data registers, the values configured on the parameter tabs are stored in the data registers when the initialization input is turned on.

This setting is shared in common with "Configuring the dates as constant setting" on page 13-15. See "Parameter tab" on page 13-16.

■ Preview

The preview shows the ON/OFF state for the output based on the settings configured on the parameter tabs in a calendar.

This function is shared in common with "Configuring the dates as constant setting" on page 13-15. See "Preview" on page 13-17.

13: THE WEEK PROGRAMMER FB

Data Register Allocation

If indirectly specifying the settings for the YEAR FB with data registers, the settings are allocated to the data registers as follows.

Storage destination	Data size (word)	R (read)/W (write)	Settings		
Start address+0	1	R/W	P 1 tab	ON settings	Year
Start address+1	1	R/W			Month, Day or Day of the week
Start address+2	1	R/W		OFF settings	Year
Start address+3	1	R/W			Month, Day or Day of the week (number of days when Specify ON duration is selected.)
Start address+4	1	R/W	P 2 tab	ON settings	Year
Start address+5	1	R/W			Month, Day or Day of the week
Start address+6	1	R/W		OFF settings	Year
Start address+7	1	R/W			Month, Day or Day of the week (number of days when Specify ON duration is selected.)
•	•	•			•
•	•	•			•
•	•	•			•
Start address+76	1	R/W	P 20 tab	ON settings	Year
Start address+77	1	R/W			Month, Day or Day of the week
Start address+78	1	R/W		OFF settings	Year
Start address+79	1	R/W			Month, Day or Day of the week (number of days when ON interval specified)

Note: "R/W" is the abbreviation for read/write. When R/W, it can be read and written. When R, it can only be read. When W, it can only be written.

Month, Day or Day of the week data allocation in a data register

The Month, Day or Day of the week are allocated as bits in 1 data register as follows.

• Month, Day

Data register (one word)

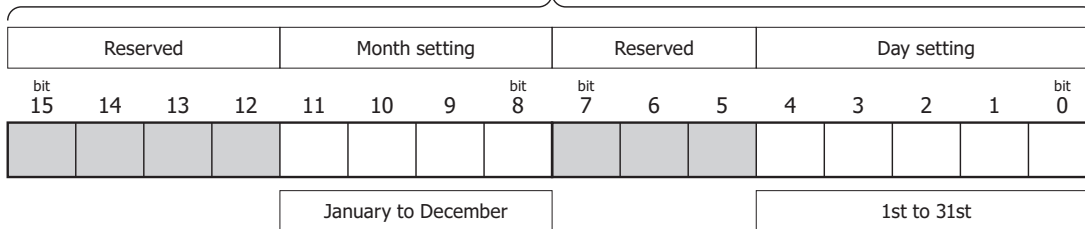

• Month, Week, Day of the week

Data register (one word)

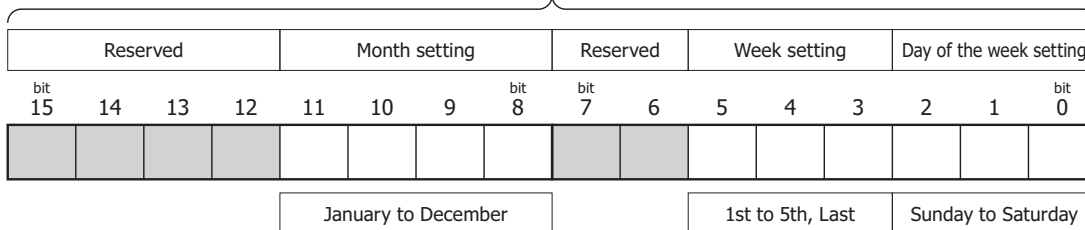

Allocation to week setting (binary) (decimal)	Allocation to day of the week setting (binary) (decimal)
001000 = 8 : 1st	000 = 0 : Sunday
010000 = 16 : 2nd	001 = 1 : Monday
011000 = 24 : 3rd	010 = 2 : Tuesday
100000 = 32 : 4th	011 = 3 : Wednesday
101000 = 40 : 5th	100 = 4 : Thursday
110000 = 48 : Last	101 = 5 : Friday
	110 = 6 : Saturday

• **Month, End of month**

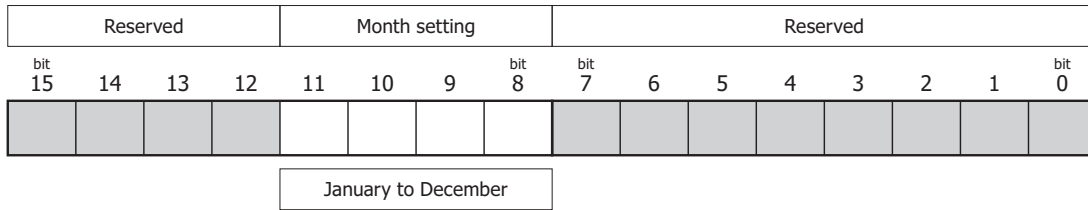

13: THE WEEK PROGRAMMER FB

Example day of the week settings

[When configured to turn on the output on January 1st]

January 1st

Reserved				Month setting				Reserved			Day setting				
bit 15	14	13	12	11	10	9	bit 8	bit 7	6	5	4	3	2	1	bit 0
0	0	0	0	0	0	0	1	0	0	0	0	0	0	0	1

Month setting: 0001 = 1
 Day setting: 00001 = 1
 The value of the data register is 100000001 (binary) = 257 (decimal).

[When configured to turn on the output on December 31st]

December 31st

Reserved				Month setting				Reserved			Day setting				
bit 15	14	13	12	11	10	9	bit 8	bit 7	6	5	4	3	2	1	bit 0
0	0	0	0	1	1	0	0	0	0	0	1	1	1	1	1

Month setting: 1100 = 12
 Day setting: 11111 = 31
 The value of the data register is 110000011111 (binary) = 3103 (decimal).

[When configured to turn on the output on the 1st Monday of January]

1st Monday of January

Reserved				Month setting				Reserved			Week setting		Day of the week setting		
bit 15	14	13	12	11	10	9	bit 8	bit 7	6	5	4	3	2	1	bit 0
0	0	0	0	0	0	0	1	0	0	0	0	1	0	0	1

Month setting: 0001 = 1 (January)
 Week setting: 001 = 1 (1st)
 Day of the week setting: 001 = 1 (Monday)
 The value of the data register is 100001001 (binary) = 265 (decimal).

[When configured to turn on the output on the 4th Thursday of June]

4th Thursday of June

Reserved				Month setting				Reserved			Week setting		Day of the week setting		
bit 15	14	13	12	11	10	9	bit 8	bit 7	6	5	4	3	2	1	bit 0
0	0	0	0	0	1	1	0	0	0	1	0	0	1	0	0

Month setting: 0110 = 6 (June)
 Week setting: 100 = 4 (4th)
 Day of the week setting: 100 = 4 (Thursday)
 The value of the data register is 11000100100 (binary) = 1572 (decimal).

[When configured to turn on the output on the last Saturday of March]

Last

Reserved				Month setting				Reserved			Week setting		Day of the week setting		
bit 15	14	13	12	11	10	9	bit 8	bit 7	6	5	4	3	2	1	bit 0
0	0	0	0	0	0	1	1	0	0	1	1	0	1	1	0

Month setting: 0011 = 3 (March)
 Week setting: 110 = 6 (Last)
 Day of the week setting: 110 = 6 (Saturday)
 The value of the data register is 1100110110 (binary) = 822 (decimal).

Timing Chart when the Execution Input Turns On during the Configured Period

When the execution input turns on or off during the period between the ON settings and the OFF settings, and when the execution input is turns on or off after 0:00 on the date configured by the ON settings under the condition that pulse output is enabled, the timing chart is as follows.

■ **When pulse output is disabled**

When the execution input is turned on, the current date is compared with the ON and OFF settings and the output turns on or off according to the result.

Setting details

ON settings	February 15, 2012
OFF settings	February 17, 2012
Output port	Q000

[When the execution input is turned on before the date specified by the ON settings]

On February 13, 2012, when the execution input is turned on, the result of the current date compared with the ON and OFF settings is not within the ON and OFF settings (February 15 to February 17, 2012). Therefore, the output remains off.

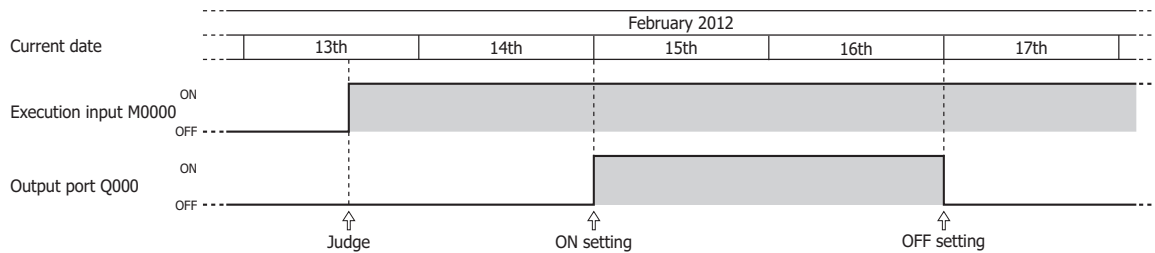

[When the execution input is turned on or off during the period between the ON and OFF settings]

On February 15, 2012, when the execution input is turned on, the result of the current date compared with the ON and OFF settings is within the ON and OFF settings (February 15 to February 17, 2012). Therefore, the output turns on. When the execution input is turned off, the output turns off.

On February 16, 2012, when the execution input is turned on again, according to the result of the current date compared with the ON and OFF settings, the output turns on.

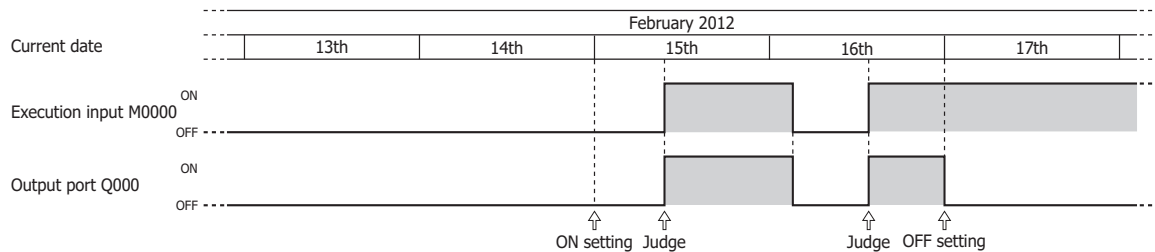

■ **When pulse output is enabled**

When the execution input is on at 0:00 on the date of the ON settings, the output is turned on for one scan. When the execution input turns on, according to the comparison of the current date with ON settings, the output is turned on for one scan.

Setting details

P 1 tab ON settings	July 02, 2012
P 2 tab ON settings	July 04, 2012
Output port	Q000

[When the execution input turns on before the date specified by the ON settings]

Since the execution input is on at 0:00 on July 02, 2012, the output turns on for one scan.

Since the execution input is on at 0:00 on July 04, 2012, the output turns on for one scan.

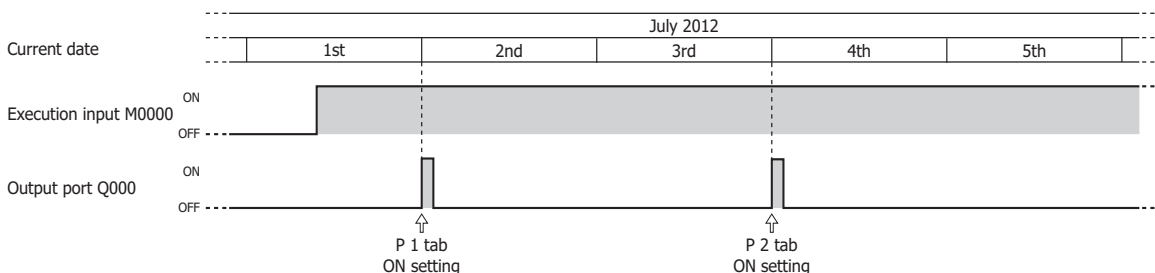

13: THE WEEK PROGRAMMER FB

[When the execution input turns on on the date specified by the ON settings]

When the execution input turns on at 0:00 on July 02, 2012, the output turns on for one scan.

When the execution input turns on after 0:00 on July 04, 2012, the output turns on for one scan.

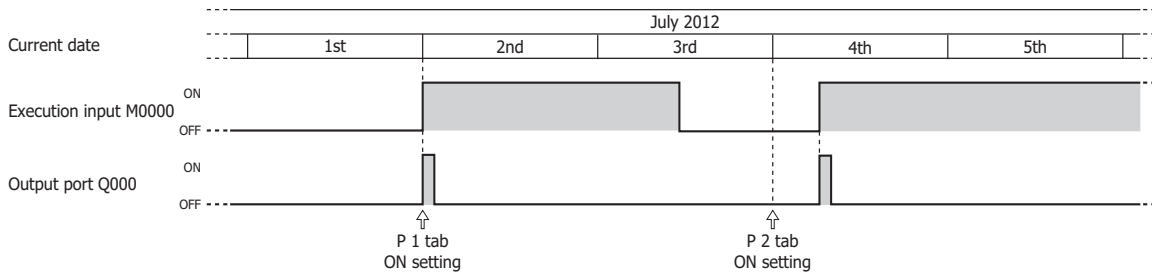

Operation Example

■ To configure the dates as constant settings

[To turn on Q000 from 0:00 on September 1, 2011, to 0:00 on June 25, 2013]

ON date : 2011/09/01
 OFF date : 2013/06/25
 Yearly setting : OFF
 Monthly setting : OFF

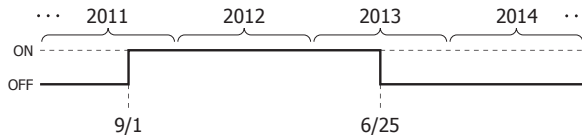

Parameter tab

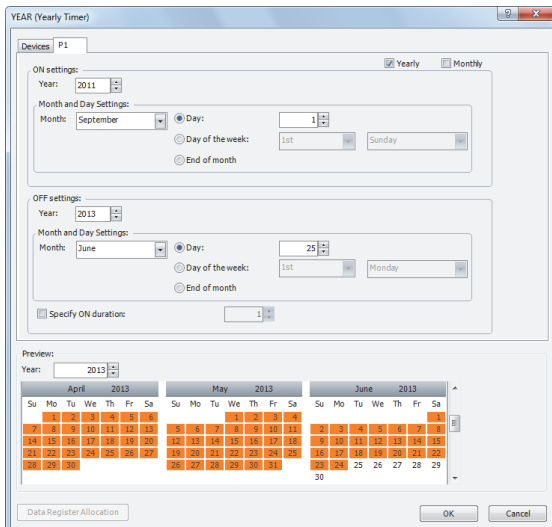

Configure the tabs as shown above and connect the YEAR FB output to Q000.

[To turn on output Q000 from 0:00 on August 12 to 0:00 on August 15 every year]

ON date : 2000/08/12
 OFF date : 2099/08/15
 Yearly setting : ON
 Monthly setting : OFF

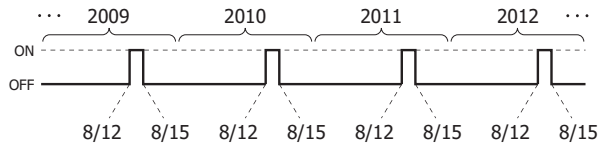

Parameter tab

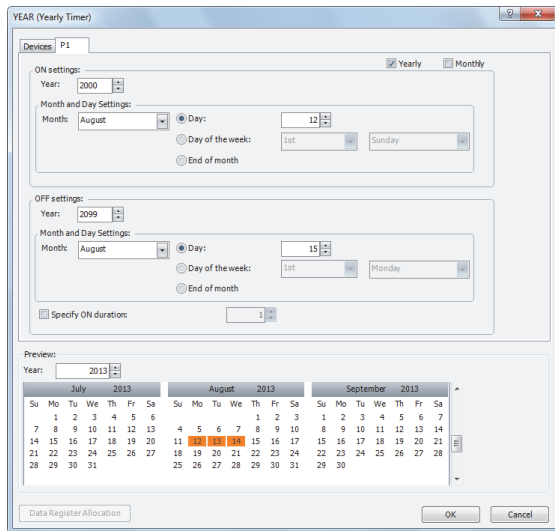

Configure the tabs as shown above and connect the YEAR FB output to Q000.

13: THE WEEK PROGRAMMER FB

[To turn on output Q000 only on the 2nd Monday of each month from 2000 to 2099]

ON date : 2000/**/2nd Monday
of each month
OFF date : 2099/**/2nd Monday
of each month + one day
Yearly setting : ON
Monthly setting : ON

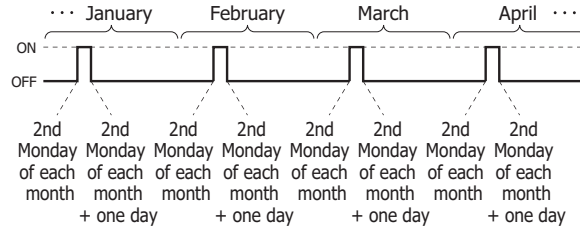

Parameter tab

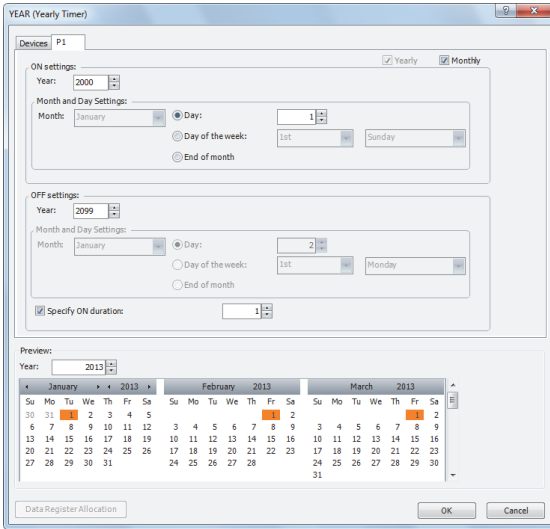

Configure the tabs as shown above and connect the YEAR FB output to Q000.

[To turn on output Q000 on the last day of every month between 2013 and 2020]

ON date : 2013/**/end of month
OFF date : 2020/**/end of month
+ one day
Yearly setting : ON
Monthly setting : ON

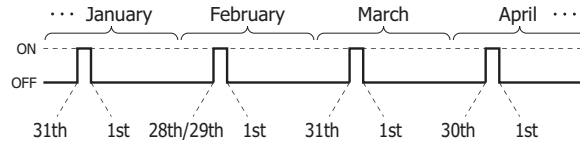

Parameter tab

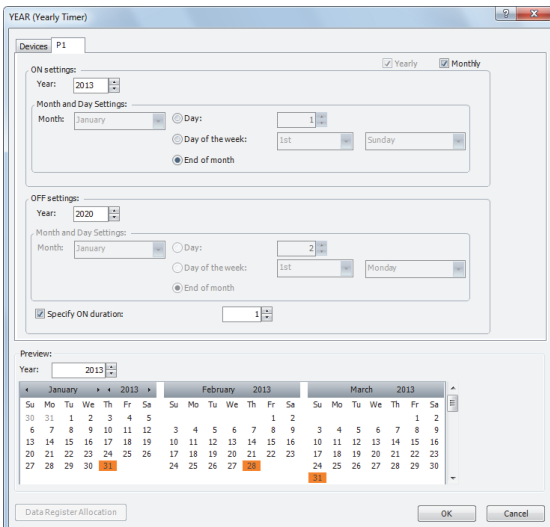

Configure the tabs as shown above and connect the YEAR FB output to Q000.

■ To configure the dates by specifying data registers

[To turn on Q000 from 0:00 on September 1, 2011, to 0:00 on June 25, 2013]

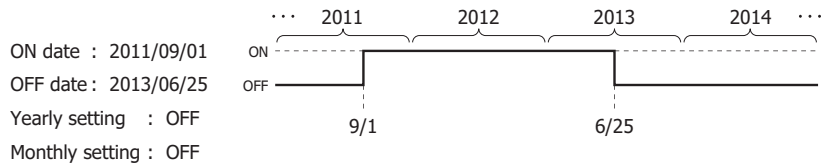

Device tab

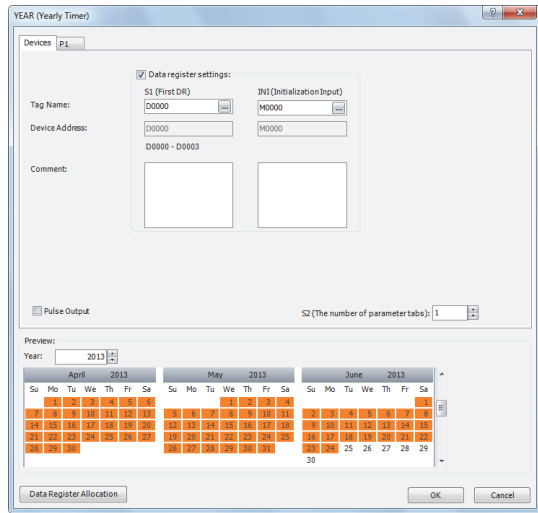

Parameter tab

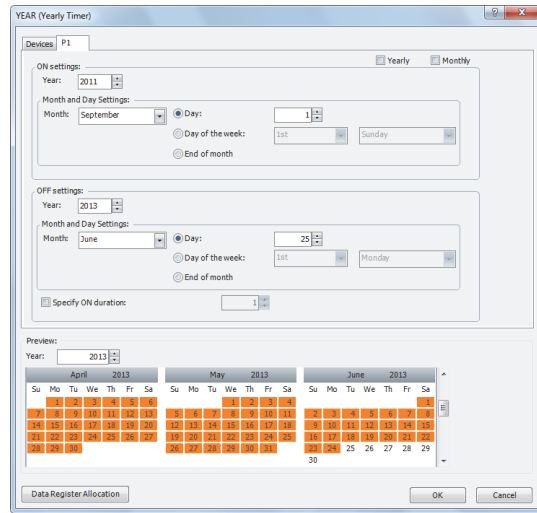

Data Register Allocation

The settings on the P 1 tab are allocated to data registers D0000 to D0003 as shown in the table below. The settings configured on the P 1 tab are stored in D0000 to D0003 when the initialization input INI is turned on.

Data register	Settings		Initial setting
D0000	P 1 tab	ON settings	Year
D0001			Month, Day
D0002		OFF settings	Year
D3			Month, Day

FBD program

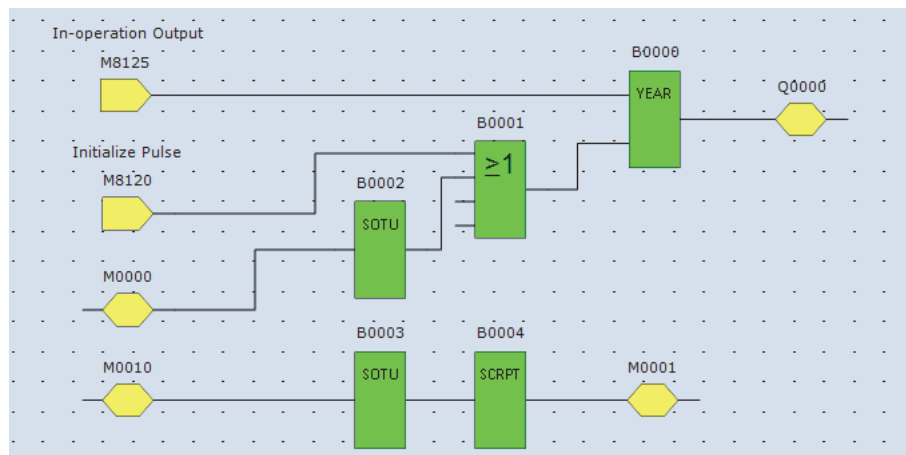

- The initial settings configured on the P 1 tab are stored in D0000 to D0003 at the first scan.
- The YEAR FB starts operating according to the values of data registers D0000 to D0003.
- When M0010 turns on, the ON settings year changes to 2013 (D0000) and the OFF settings year changes to 2020 (D0002).
- When M0001 turns on, all of the YEAR FB settings (D0000 to D0003) return to the initial settings.

14: THE INTERFACE FB

Introduction

The interface FB displays the specified data on the SmartAXIS Pro LCD.

MSG (Message)

The MSG FB displays data such as text and device values on the SmartAXIS Pro LCD.

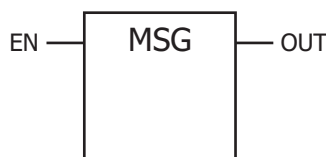

Operation

When the execution input (EN) is on, a message is displayed on the SmartAXIS Pro LCD according to the content configured in the MSG FB dialog box, and the output (OUT) turns on. When the execution input is off, the MSG FB does not operate and the output turns off.

The following types of data can be displayed on the SmartAXIS Pro LCD.

Device values can be displayed.

- Word device values can be displayed as numeric values according to the specified data type.
For details, see "Insert Word Device" on page 14-5.
- Word device values can be displayed as bar graphs.
For details, see "Insert Bar Graph" on page 14-9.
- Text can be displayed and switched according to the value of a bit device (input, output, internal relay, shift register, timer contact, or counter contact).
For details, see "Insert Bit Device" on page 14-7.

Arbitrary text can be displayed.

- The specified text can be displayed.
For details, see "Edit MSG (Message) dialog box" on page 14-3.

The text display effects can be configured.

- Text can be scrolled, blinked, or inverted.
For details, see "Insert Text with Effect" on page 14-8.

Date/time data can be displayed.

- The current date/time and the date/time when the MSG FB execution input turned on can be displayed on the LCD.
For details, see "7. Special Data" on page 14-4.

The language for displayed text can be selected from 9 languages.

- Text can be displayed in 9 languages using 4 types of character sets.
For details, see "MSG FB Common Settings" on page 14-10.

The text display settings can be configured.

- The scroll unit, scroll speed, and blinking speed can be configured.
For details, see "MSG FB Common Settings" on page 14-10.

Device values can be modified.

- Device values displayed with the MSG FB can be modified on the SmartAXIS Pro LCD.
For details, see "Modifying Device Values on the SmartAXIS Pro" on page 14-18.

Note: A maximum of 50 MSG FB can be entered in a user program. Only one MSG FB message can be displayed on the LCD at a time. PRI for the MSG FB stores the MSG FB priority. When the display conditions for multiple MSG FBs are satisfied, the messages are displayed according to the priority set for the MSG FB.

For MSG FB priority, see "10. Priority" on page 14-4.

Applicable SmartAXIS

FT1A-12	FT1A-24	FT1A-40	FT1A-48	FT1A Touch
▲	▲	▲	▲	—

▲ SmartAXIS Pro only (The MSG FB cannot be used on Lite.)

14: THE INTERFACE FB

Parameters

Parameter		Function	Range	Description
Number	B	Block number	B0 to B999 *1	Unique number to identify each special FB. The block number is automatically assigned in ascending order from zero. The block number can be changed to a desired number. However, the block numbers already used in any other FBs cannot be used.
Input	EN	Execution input	On/off	When the execution input is on, a message is displayed on the SmartAXIS Pro LCD according to the content configured in the MSG FB dialog box.
Output	OUT	Output	–	When the execution input is on, the output turns on. When the execution input is off, the output turns off.
Parameters	PRI	Priority	0 to 49	The priority of the MSG FB. When the execution inputs of two or more MSG FBs are on, the message of the MSG FB with the highest priority is displayed on the LCD, out of all the MSG FB with execution inputs that are on. 0 is the highest priority and 49 is the lowest priority. Specify the priority with a constant value.

*1 B0 to B199 for the 12-I/O type.

Valid Devices

Parameter	Function	I	Q	M	R	T	TC	TP	C	CC	CP	B	D	AI	Constant
EN	Execution input	X	X	X	X	X	–	–	X	–	–	X	–	–	–
PRI	Priority	–	–	–	–	–	–	–	–	–	–	–	–	–	X

Settings

For the MSG FB settings, there are settings for the individual MSG FB and settings that are common to all the MSG FBs.

Note: Settings that are common to all the MSG FBs are modified in the Function Area Settings dialog box of WindLDR. For details, see "MSG FB Common Settings" on page 14-10.

■ MSG FB Individual Settings

The settings for the individual MSG FB, such as texts and devices to display and the priority, can be configured in the Edit MSG FB dialog box.

Edit MSG (Message) dialog box

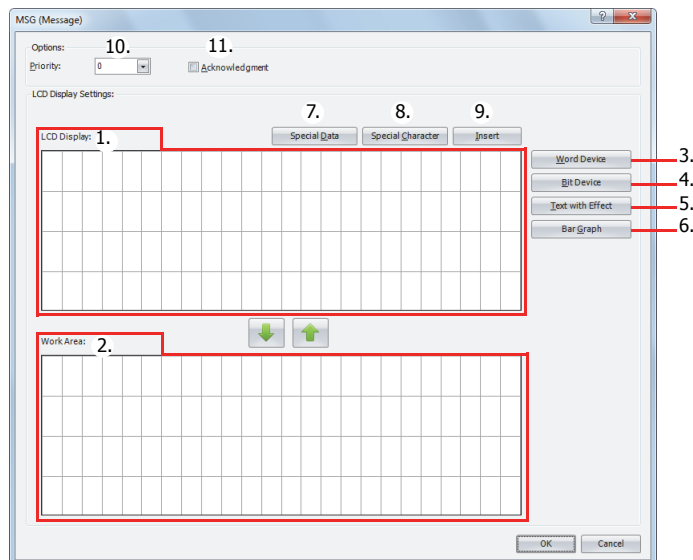

1. LCD Display

The screen displayed on the SmartAXIS Pro LCD when the MSG FB is executed can be configured in this area. Enter characters at the cursor position using the keyboard. The character input method (insert/overwrite) is changed by clicking **Insert** (9).

Note: Text entered on the LCD Screen (1) with the keyboard cannot be set to scroll, blink, or invert. To scroll, blink, or invert the text, enter the text with **Text with Effect** (5) and configure the display options. For details on inserting text with effects, see "Insert Text with Effect" on page 14-8.

2. Work Area

This area is used when editing the LCD screen. This area is for temporarily relocating text and device data.

Text and device data can be moved between the LCD Screen and the Work Area with  or .

When the dialog is closed, the work area data is discarded.

3. Word Device

Inserts a word device at the cursor position. The value of the specified word device is displayed on the SmartAXIS Pro LCD. For details, see "Insert Word Device" on page 14-5.

4. Bit Device

Inserts a bit device in the area specified by the cursor. Two different items of text can be switched between and displayed on the SmartAXIS Pro LCD according to the value of the specified bit device. For details, see "Insert Bit Device" on page 14-7.

5. Text with Effect

Inserts text in the area specified by the cursor. The specified text is displayed on the SmartAXIS Pro LCD. For details, see "Insert Text with Effect" on page 14-8.

6. Bar Graph

Inserts a bar graph in the area specified by the cursor. The value of the specified device is displayed as a bar graph on the SmartAXIS Pro LCD. For details, see "Insert Bar Graph" on page 14-9.

7. Special Data

Special data such as the current date and time can be entered at the cursor position. Select the data to enter on the special data list window popped up when **Special Data** is pressed. Size of the area used on the LCD screen varies based on the selected special data.

Special data	Display		Occupied Area (Lines x columns)
	Display type	Display example (January 1, 2012, 13:30)	
Current date	YYYY/MM/DD	2012/01/01	1 x 10
Current time	HH:MM	13:30	1 x 5
Date the input to the MSG FB is turned on	YYYY/MM/DD	2012/01/01	1 x 10
Time the input to the MSG FB is turned on	HH:MM	13:30	1 x 5

8. Special Character

A special character can be entered at the cursor position. Select the character to enter on the special characters list window popped up when **Special Character** is pressed. The special characters that can be used are as follows.

Special characters list							
▼	▲	◀	▶	°C	°F	°	±

9. Insert/Overwrite

Selects insert or overwrite as the character input mode. Click this button to switch the input mode.

10. Priority

The priority of the MSG FB can be configured between 0 to 49. 0 is the highest priority and 49 is the lowest priority.

- The same priority cannot be set for multiple MSG FBs.
- When inputs to two or more MSG FBs turns on, the message of the MSG FB with the highest priority is displayed, out of all the MSG FBs with inputs that are on.
- When the MSG FB input with the highest priority changes from on to off, the message for the MSG FB with the next highest priority is displayed (the priority is checked when the input changes).
- If **Acknowledgement** (11) is enabled for the MSG FB with the highest priority, even after the input changes from on to off, the same message is kept displayed. The message for the MSG FB with the next highest priority is displayed when the SmartAXIS Pro module **OK** (OK) button is pressed.

Note: When you press the **▲** (up) or **▼** (down) button on the SmartAXIS Pro, the messages are switched between the MSG FBs that have inputs that are on. Messages are also switched when the acknowledgement for the MSG FB is enabled.

```
Motor 5
STOP AT
10:12
!! ACTION !!
```

Example: Message output in Priority 30

```
Motor 2
3000
hours
!! MAINTENANCE !!
```

Example: Message output in Priority 10

```
Running
2012/OCT/01/MON
09:00:12
```

Date and current time

11. Acknowledgment

When acknowledgement is enabled, the message is kept displayed even after the input to the MSG FB is turned off. The message is closed when **OK** (OK) button on the SmartAXIS Pro is pressed, and then the message for the MSG FB with the next highest priority is displayed, out of all the MSG FB with inputs that are on at that time. If the input to the MSG FB is on, the message is not closed even when the **OK** (OK) button is pressed.

Insert Word Device

The value of the specified word device can be displayed on the SmartAXIS Pro LCD.

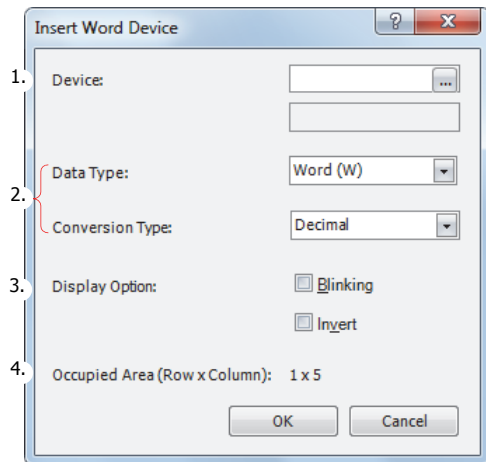

1. Device

Enter the device to display.

Valid Devices

W (word)	TC, TP, CC, CP, D
I (integer)	D
D (double word)	CC, CP, D
L (long)	D
F (float)	D

2. Data Type and Conversion Type

Select the display type for the specified device. The size of the area used on the LCD screen varies based on the specified data type and conversion type.

Data Type	Conversion Type	Occupied Area	Example on LCD
W (word)	Decimal	5	65535
	Hexadecimal	4	FFFF
I (integer)	Decimal	6	-32768
D (double word)	Decimal	10	4294967295
	Hexadecimal	8	FFFFFFFF
L (long)	Decimal	11	-2147483648
F (float)	Decimal	13	0.1234567* ¹

*1 For SmartAXIS Pro system software version 2.20 and earlier, this is displayed as exponent notation. For SmartAXIS Pro system software version 2.21 and later, this becomes decimal notation or exponent notation depending on the value. For details, see "Floating Point Value Notation on LCD" on page 14-6.

3. Display Option

Configure the options to blink or invert the value of the specified device. For the blinking speed, see "MSG FB Common Settings" on page 14-10.

Display Option	Description
Blinking	Blinks the value of the specified device.
Invert	Inverts the display of the specified value.

4. Occupied Area

Shows the size of the area to be used on the LCD screen (Lines: 1, columns: 4 to 13). The area is determined by the selected data type and conversion type.

Floating Point Value Notation on LCD

The SmartAXIS Pro system software version 2.21 or later supports decimal and exponent notations for the floating-point values displayed on LCD. The notation depends on the value to display. Whether or not to use decimal notation or exponent notation is determined according to the single-precision floating point definition in IEEE 754 and the internal system function included in the SmartAXIS Pro.

The IEEE 754 single precision format consists of three fields: a 23-bit fraction, f; an 8-bit biased exponent, e; and 1-bit sign, s. These fields are stored contiguously in one 32-bit word, as shown in the figure below. Bits 0:22 contain the 23-bit fraction, f, with bit 0 being the least significant bit of the fraction and bit 22 being the most significant; bits 23:30 contain the 8-bit biased exponent, e, with bit 23 being the least significant bit of the biased exponent and bit 30 being the most significant; and the highest-order bit 31 contains the sign bit, s.

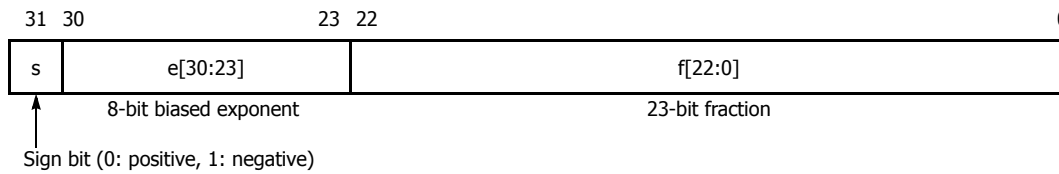

The table below shows the correspondence between the values of the three constituent fields s, e, and f and the value represented by the single precision format bit pattern.

When the value is ±0, denormalized number, or normalized number, the value is displayed according to the internal system function of the SmartAXIS Pro.

Value	Exponent field e	Fraction field f	Representation
±0	e=0	f=0	0
Denormal numbers	e=0	f≠0	<ul style="list-style-type: none"> Displayed in decimal notation 0.0001 ≤ Value < 9999999.5 (Number of significant digits is 7 digits, 8th digit is rounded) Displayed in exponent notation Value < 0.0001 Value ≥ 9999999.5
Normal numbers	0<e<255	Arbitrary	
±∞ (± infinities)	e=255	f=0	INF
NaNs (Not a number)		f≠0	NAN

Example: This table shows the representation on the LCD for the following floating-point values.

Value	Representation in LCD	
	System software version 2.20 and earlier	System software version 2.21 and later
1234567	1.234567E+06	1234567
12345678	1.234568E+07	1.234568E+07
1234567.8	1.234568E+06	1234568
0.0001	1.000000E-04	0.0001
0.00001	1.000000E-05	1E-05
0.000001	1.000000E-06	1E-06
0.0000001	1.000000E-07	1E-07
0.123456	1.234560E-01	0.123456
0.1234567	1.234567E-01	0.1234567
0.12345678	1.234567E-01	0.1234568
0.0000012	1.200000E-06	1.2E-06
1.2345678	1.234568E+00	1.234568
0	0.000000E+00	0
0.0001234568	1.234568E-04	0.0001234568

Insert Bit Device

Two different texts (ON Text and OFF Text) can be displayed on the SmartAXIS Pro LCD according to the value of the specified bit device (when on/when off).

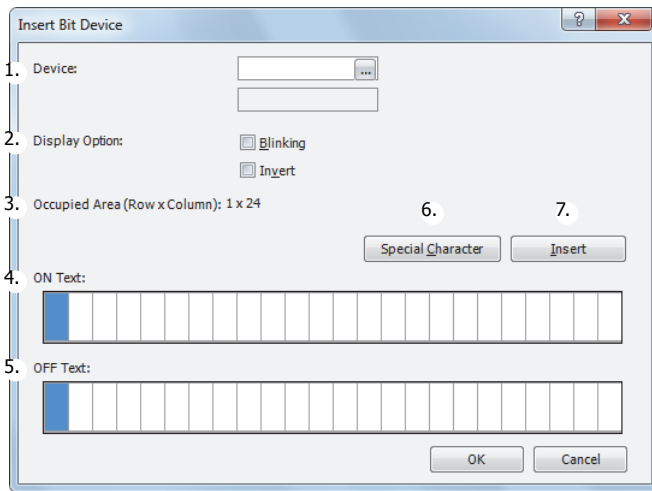

1. Device

Enter the device to display.

Valid Devices

I	Q	M	R	T	TC	TP	C	CC	CP	B	D	AI	Constant
X	X	X	X	X	-	-	X	-	-	-	-	-	-

2. Display Option

Configure the options to blink or invert the text. For the blinking speed, see "MSG FB Common Settings" on page 14-10.

Display Option	Description
Blinking	Blinks the specified text.
Invert	Inverts the display of the specified text.

3. Occupied Area

Shows the size of the area to be used on the LCD screen (Lines: 1, columns: 1 to 24). The display size is determined by the selected range on the LCD screen area (or work area). If multiple lines are selected, the area at the top line in the selected range is used.

4. ON Text

Enter the text to display when the specified device is on. Up to 24 single-byte characters can be entered. A space is also counted as one character.

5. OFF Text

Enter the text to display when the specified device is off. Up to 24 single-byte characters can be entered. A space is also counted as one character.

6. Special Character

Enters a special character at the cursor position. Select the character to enter on the special characters list window popped up when **Special Character** is pressed. For the special characters, see "8. Special Character" on page 14-4.

7. Insert/Overwrite

Selects whether to insert or overwrite characters when entering new characters.

Insert Text with Effect

The specified text can be displayed on the SmartAXIS Pro LCD.

[When scrolling is disabled]

[When scrolling is enabled]

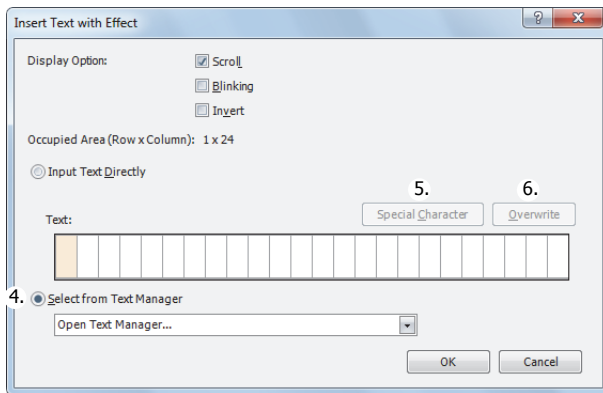
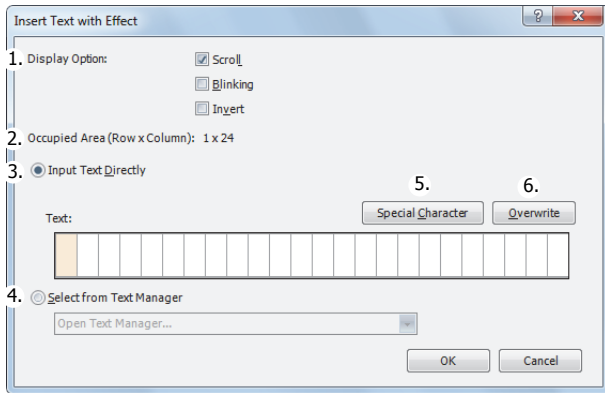

1. Display Option

Configure the options to scroll, blink, or invert the specified text. For scroll unit, scroll speed, and blinking speed, see "MSG FB Common Settings" on page 14-10.

Display Option	Description
Scroll	Scrolls the specified text.
Blinking	Blinks the specified text.
Invert	Invert the display of the specified text.

2. Occupied Area

Shows the size of the area to be used on the LCD screen (Lines: 1, columns: 1 to 24). The occupied area is determined by the selected range on the LCD screen area (or work area). If multiple lines are selected, the area at the top line in the selected range is used.

3. Input Text Directly

Directly enter the characters to display. A space is also counted as one character. The message can be entered up to 24 single-byte characters. However, you cannot enter a number of characters that exceeds the occupied area. The message can be entered up to 48 single-byte characters.

4. Select from Text Manager

Select the text to display from the text manager. This can be selected only when the scroll is enabled.

5. Special Character

Enters a special character at the cursor position. Select the character to enter on the special characters list window popped up when **Special Character** is pressed. For the special characters, see "8. Special Character" on page 14-4.

6. Insert/Overwrite

Selects whether to insert or overwrite characters when entering new characters.

Insert Bar Graph

The value of the specified device can be displayed as a bar graph on the SmartAXIS Pro LCD.

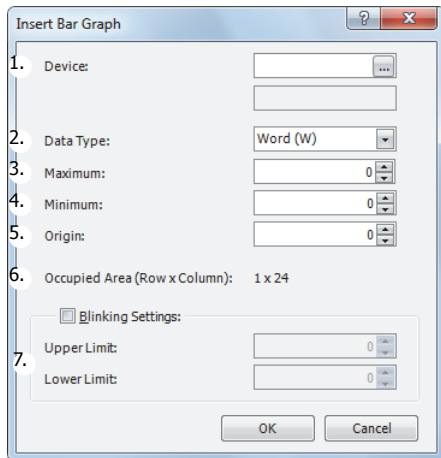

1. Device

Enter the device to display as a bar graph.

Valid Devices

W (word)	TC, TP, CC, CP, D
I (integer)	D
D (double word)	CC, CP, D
L (long)	D
F (float)	D

2. Data Type

Selects the data type for the specified device.

Data Type

W (word)	X
I (integer)	X
D (double word)	X
L (long)	X
F (float)	—

For data types, see "Data types" on page 4-10.

3. Maximum

Enter the maximum value for the bar graph. If the device value is larger than the maximum value, the bar graph is displayed as the maximum value. The valid range varies based on the data type. See "Data types" on page 4-10.

4. Minimum

Enter the minimum value for the bar graph. If the device value is smaller than the minimum value, the bar graph is displayed as the minimum value. The valid range varies based on the data type. See "Data types" on page 4-10.

5. Origin

Enter the value to be the origin of the bar graph. If the device value is larger than the origin value, the bar graph is displayed on the right side of the origin value. If the device value is smaller than the origin value, the bar graph is displayed on the left side of the origin value. The valid range varies based on the data type. See "Data types" on page 4-10. The origin value must satisfy the condition of $\text{Minimum} \leq \text{Origin} \leq \text{Maximum}$.

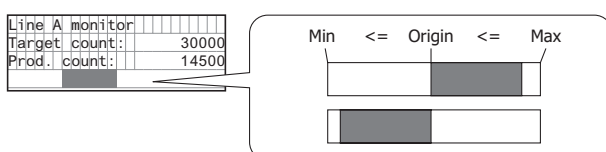

6. Occupied Area

The occupied area is determined by the selected range on the LCD screen area (or work area). If multiple lines are selected, the area at the top line in the selected range is used (Lines: 1, columns: 1 to 24).

7. Blinking Settings

Blink the bar graph when the value of the specified device exceeds the upper or lower limit.
For the blinking speed, see "MSG FB Common Settings" on page 14-10.

Blinking Settings	Description
Upper limit	The bar graph is blinked when the value of the specified device is larger than the upper limit.
Lower limit	The bar graph is blinked when the value of the specified device is smaller than the lower limit.

Maximum, minimum, upper limit, and lower limit values must satisfy the following condition.

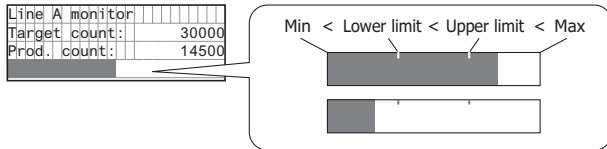

MSG FB Common Settings

The common settings, character set, scroll unit, scroll speed, and blinking speed, for the message to display can be configured. The common settings are configured in the WindLDR Function Area Settings dialog box.

Note: The common settings for the MSG FBs are applicable for all MSG FBs in the user program. For the MSG FB individual settings, see "MSG FB Individual Settings" on page 14-3.

Function Area Settings dialog box

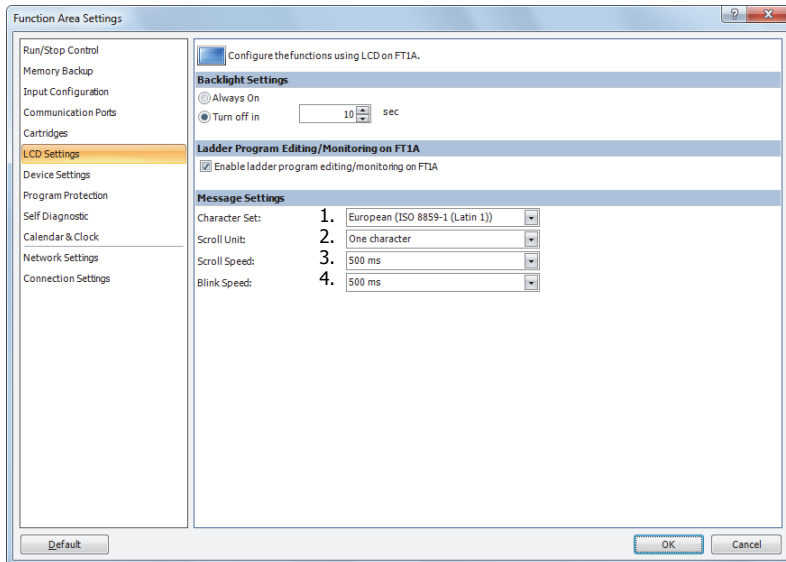

1. Character Set

The character set used for the messages can be configured from the following.

Selection	Character Set	Languages usable in the MSG FB
European	ISO-8859-1 (Latin 1)	Italian, English, Dutch, Spanish, German, French
Japanese	Shift-JIS	Japanese
Chinese	GB2312	Chinese (simplified)
Cyrillic	ANSI 1251	Russian

2. Scroll Unit

The unit to scroll the texts can be configured.

1 character	Scrolls the text in 1 character units.
1 dot	Scrolls the text in 1 dot units.

3. Scroll Speed

The speed to scroll the texts can be configured. The setting range is 500 to 1000 ms.

4. Blinking Speed

The speed to blink the texts can be configured. The setting range is 500 to 1000 ms.

Note: The MSG FB character set can be configured irrespective of the SmartAXIS Pro system menu language.

MSG FB Configuration Example

[Display the room temperature when M0000 is on and the outdoor temperature when M0000 is off]

The room temperature/outdoor temperature value is stored in D0002.

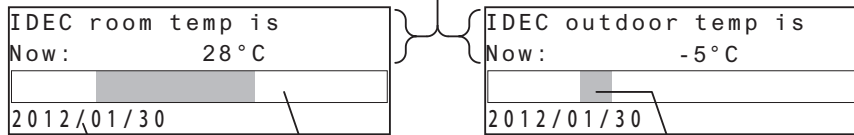

Displays the current date.

Bar graph is used to Show the rise and fall in temperature visually.

Settings

Configure the following items.

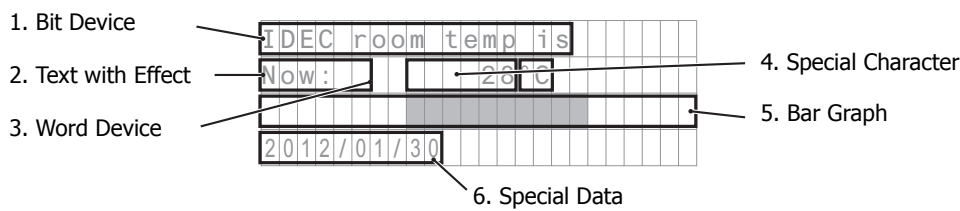

Setting items		Setting details
1. Bit Device	Device	M0000
	Display Option	All disabled (scroll, blink, invert)
	ON Text	IDEC room temp is:
	OFF Text	IDEC outdoor temp is:
2. Text with Effect	Text	Now:
	Display Option	All disabled (scroll, blink, invert)
3. Word Device	Device	D0002
	Data Type	I (integer)
	Conversion Type	Decimal
4. Special Character		°C
5. Bar Graph	Device	D0002
	Data Type	I (integer)
	Max	50
	Min	-20
	Origin	0
	Blinking Settings	Disabled
6. Special Data		Current date

■ Operation Procedure

1. On the WindLDR right-click menu, click **Advanced > Display > MSG (Message)**.
2. The MSG (Message) dialog box opens.

Configuring the bit device

3. Select the area to insert the parameter and click **Bit Device**.

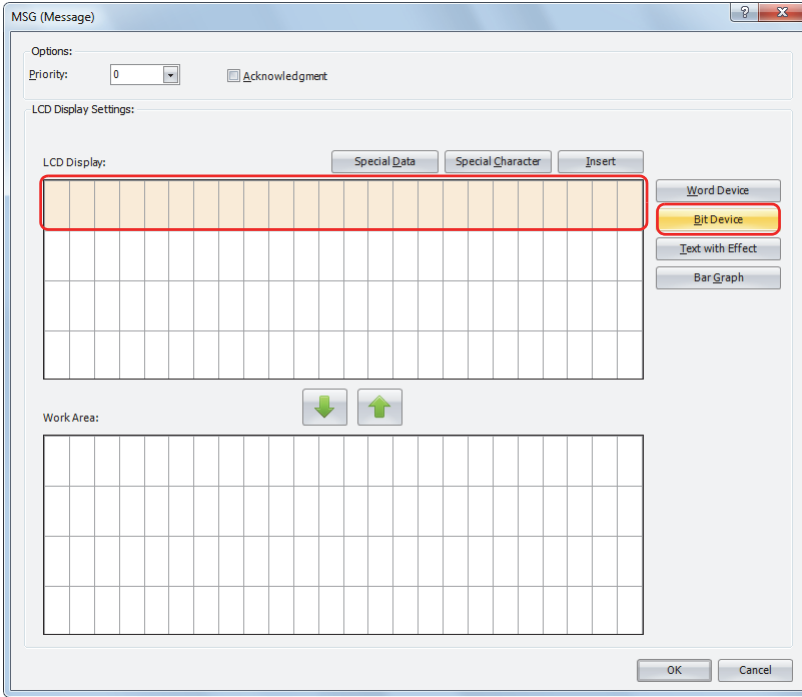

The Insert Bit Device dialog box opens.

4. Configure the parameters so that the room temperature is displayed when M0000 is on and the outdoor temperature is displayed when M0000 is off. Set **Device** to "M0000". Using the keyboard, enter "IDEC room temp is:" as the ON Text and "IDEC outdoor temp is:" as the OFF Text. Under **Display Option**, disable all of the options.

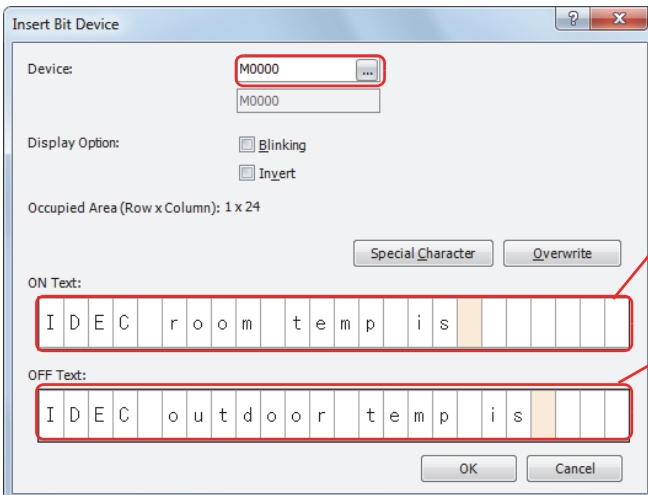

Displayed when M0000 is on

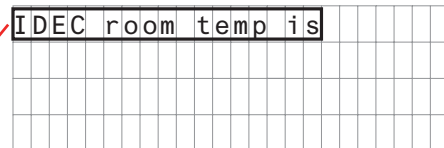

Displayed when M0000 is off

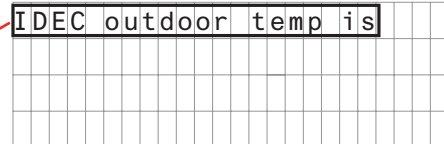

- After the settings are configured, click **OK**.
The configured content is displayed on the LCD screen area.

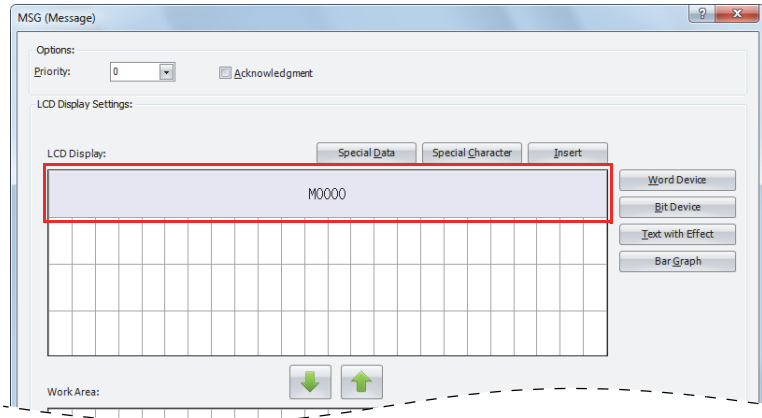

Configuring the text with effect

- Select the six-column area from the start of the second line and click **Text with Effect**.

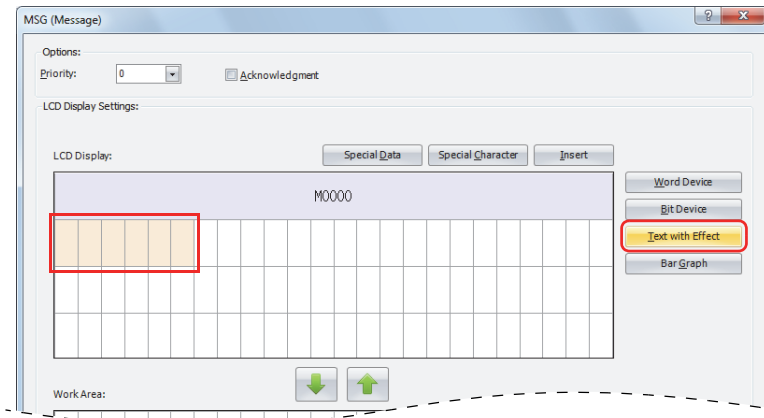

Note: The text can also be entered directly on the LCD screen area. In the sample above, move the cursor to the start of the second line and enter "Now:" with the keyboard. When you directly enter the text, proceed to "Configuring the word device" on page 14-14, step 9.

The Insert Text with Effect dialog box opens.

- In Text, enter "Now:" with the keyboard. Under **Display Option**, disable all of the options.

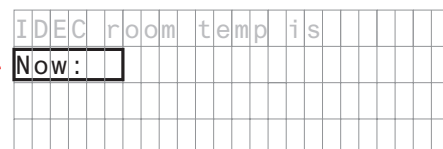
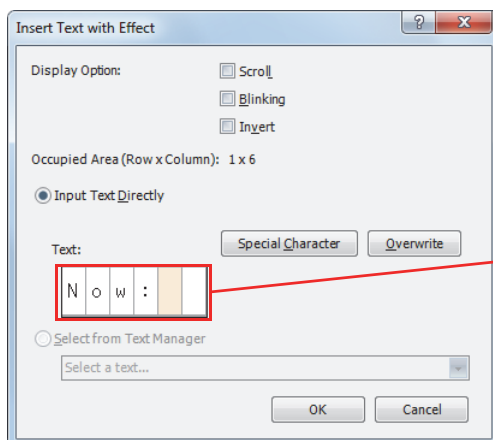

14: THE INTERFACE FB

- After the settings are configured, click **OK**.
The configured content is displayed on the LCD screen area.

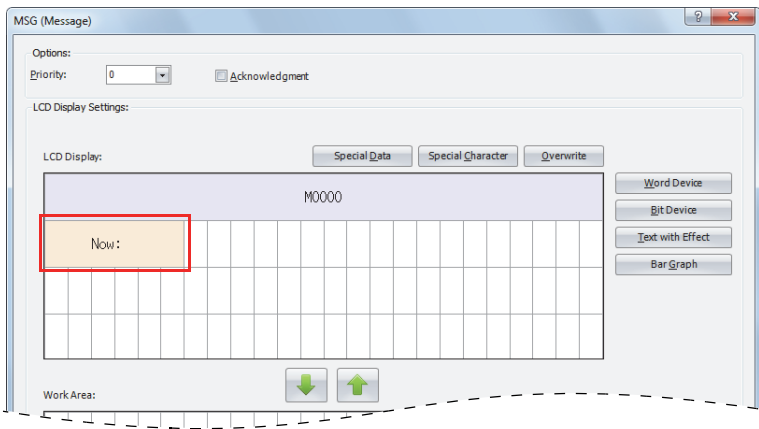

Configuring the word device

- Select the area at the ninth column on the second line and click **Word Device**.

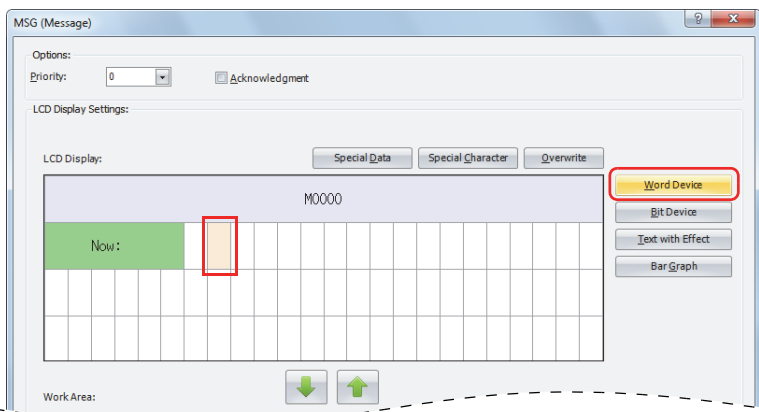

The Insert Word Device dialog box opens.

- Set **Device** to "D0002", **Data Type** to **I (Integer)**, and **Conversion Type** to **Decimal**.
Under **Display Option**, disable all of the options.

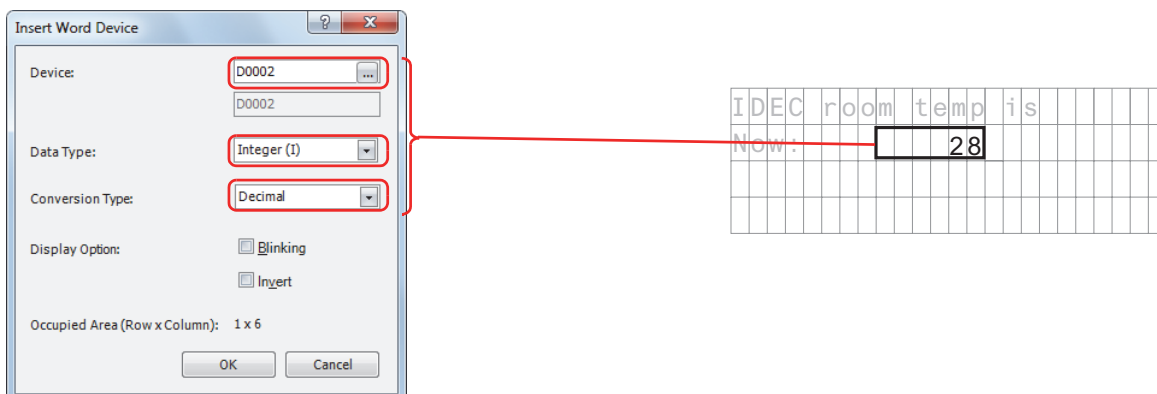

11. After the settings are configured, click **OK**.
The configured content is displayed on the LCD screen area.

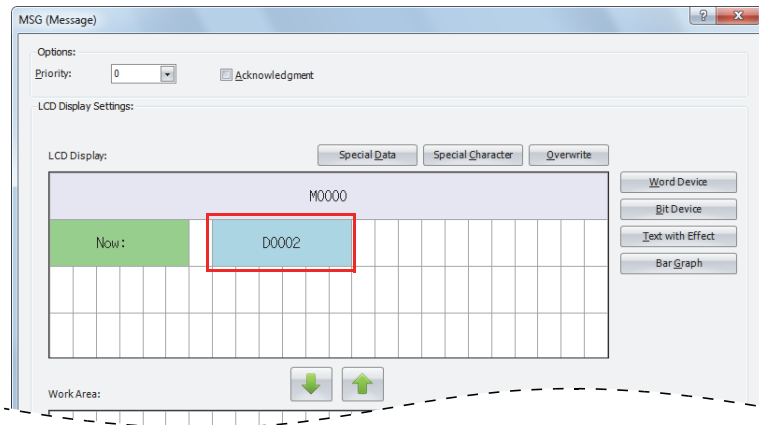

Configuring the special character

12. Select the area at the 15th column on the second line and click **Special Character**.

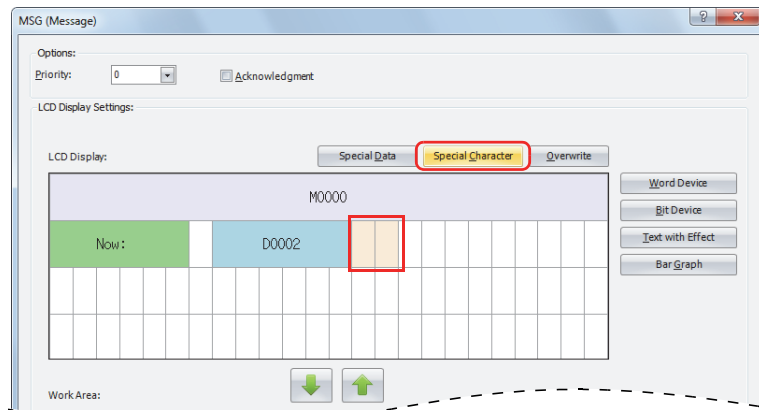

The **Special Characters List** window is popped up.

13. Double-click on **°C**.



The configured content is displayed on the LCD screen area.

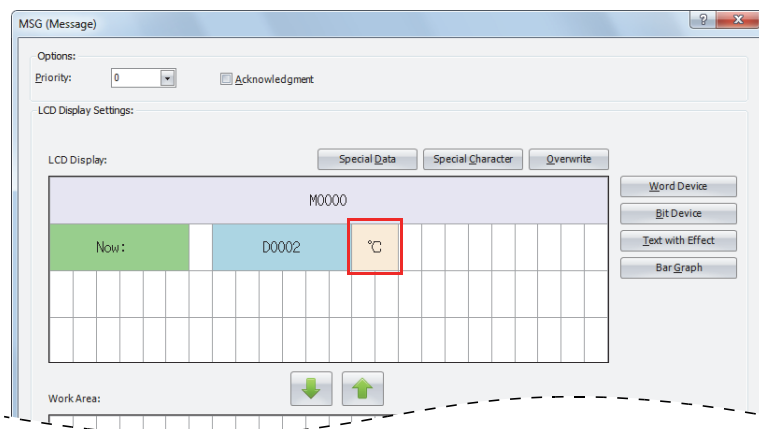

14: THE INTERFACE FB

Configuring the bar graph

14. Select the entire area on the third line and click **Bar Graph**.

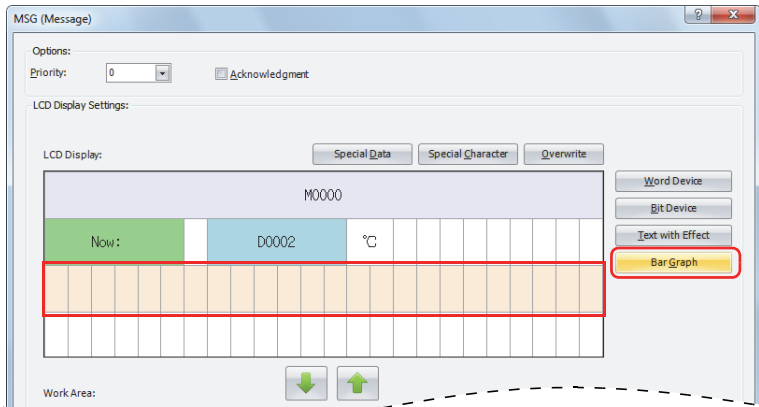

The Insert Bar Graph dialog box opens.

15. Set **Device** to "D0002", **Data Type** to "Integer (I)", **Maximum** to "50", **Minimum** to "-20", and **Origin** to "0". Disable the blinking settings.

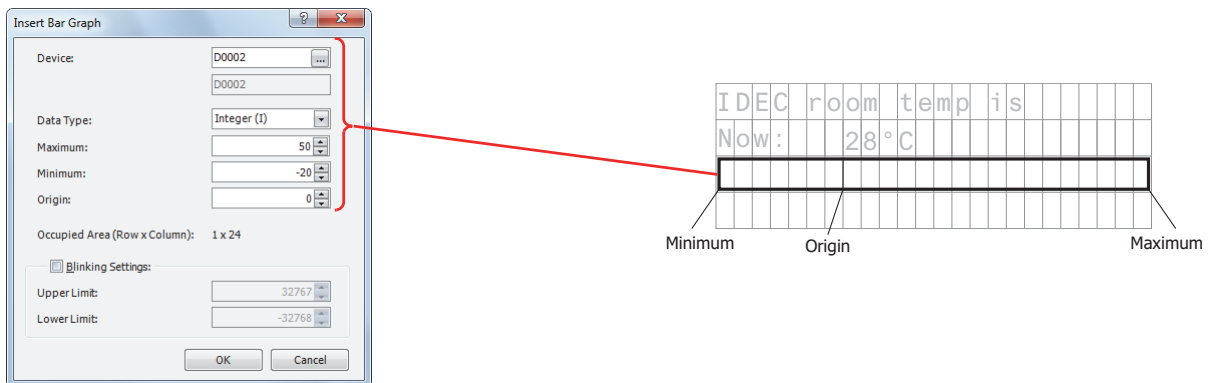

16. After the settings are configured, click **OK**.

The configured content is displayed on the LCD screen area.

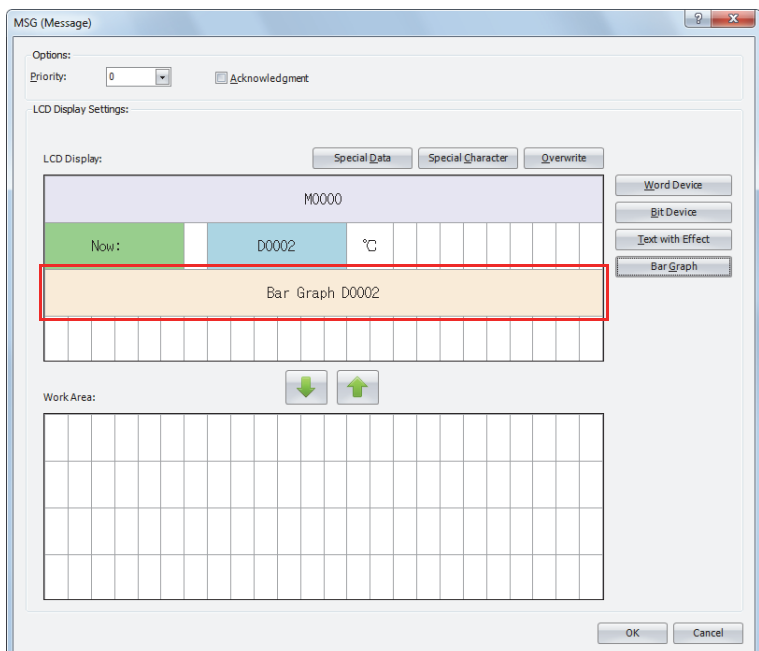

Configuring the special data

17. Select the left edge of the fourth line and click **Special Data**.

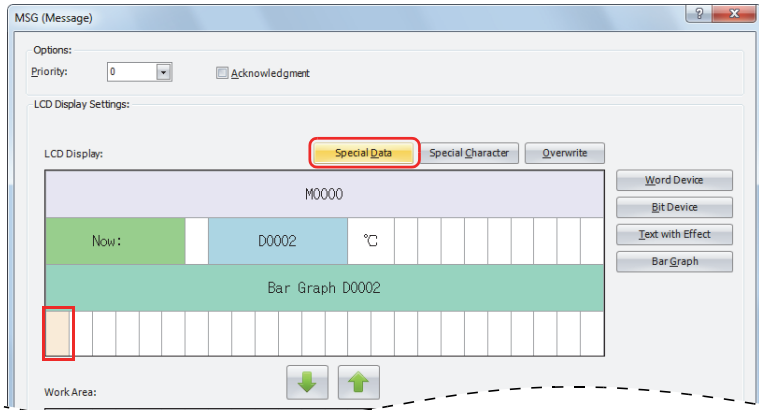

The **Special Data List** window is popped up.

18. Double-click on the **Current date**.

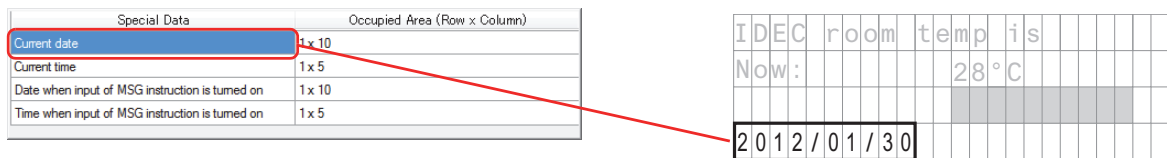

19. After the settings are configured, click **OK**.

The configured content is displayed on the LCD screen area.

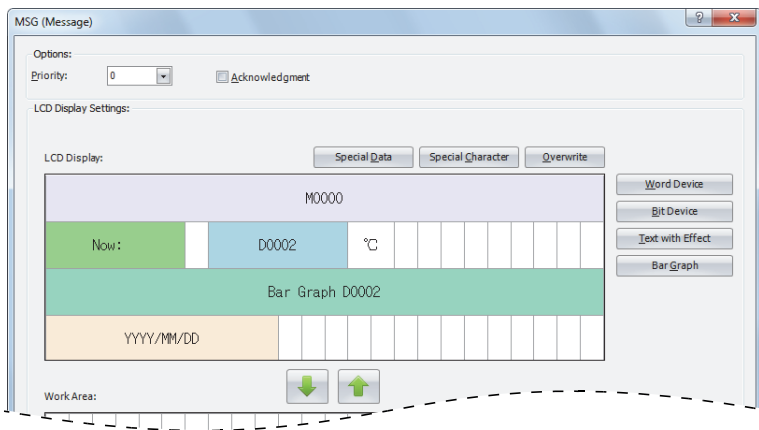

This concludes configuring the settings.

LCD display

When M0000 is on, the room temperature stored in D0002 is displayed as the numeric value (°C) and bar graph.

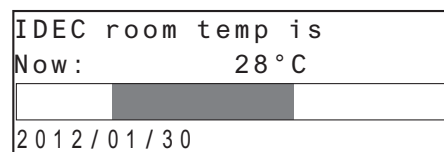

When M0000 is off, the outdoor temperature stored in D0002 is displayed as the numeric value (°C) and bar graph.

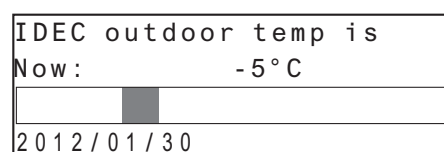

14: THE INTERFACE FB

Modifying Device Values on the SmartAXIS Pro

The values of the word devices displayed on the SmartAXIS Pro LCD can be modified using the SmartAXIS Pro operation buttons. The values cannot be modified when the SmartAXIS Pro is stopped.

[To modify the value of word device CP0]





Line A monitor									
Plan:	CP0	Actual:	CC0						
Diff:	D0								
Bar Graph CC0									

When the SmartAXIS Pro is running and the input to the MSG FB is turned on, the following screen will be displayed on the LCD.



Line A monitor									
Plan:	60000	Actual:	20000						
Diff:	40000								
Bar Graph CC0									

While the above message is displayed, press and hold the  (OK) button and the cursor is displayed on the devices that can be modified.

Line A monitor									
Plan:	60000	Actual:	20000						
Diff:	40000								
Bar Graph CC0									

Move the cursor to the device you wish to edit using the  (up)  (down)  (left)  (right) buttons and press the  (OK) button to change the device in the editable state.

Line A monitor									
Plan:	60000	Actual:	20000						
Diff:	40000								
Bar Graph CC0									

Press the  (right) button to move the cursor to the fourth digit, and then use the  (up) button to modify the target value to "65000".

Line A monitor									
Plan:	65000	Actual:	20000						
Diff:	40000								
Bar Graph CC0									

Press the  (OK) button to confirm the modifications.

Line A monitor									
Plan:	65000	Actual:	20000						
Diff:	40000								
Bar Graph CC0									

Scrolling text example

[Character Set: European scroll speed: 500 ms]

When a text with effect is set to scroll, the text is displayed on the SmartAXIS Pro LCD as follows.

When scrolling a text longer than the specified area on the LCD

Text: "IDEC Corporation SmartAXIS"

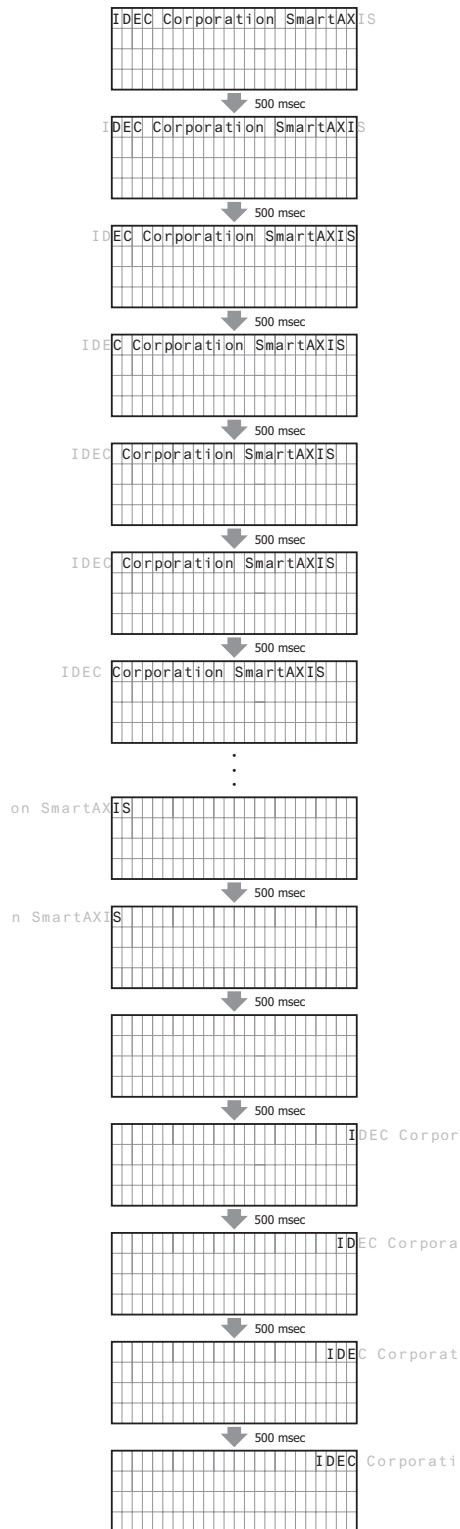

When scrolling a text shorter than or equal to the specified area on the LCD

Text: "IDEC Corp. SmartAXIS"

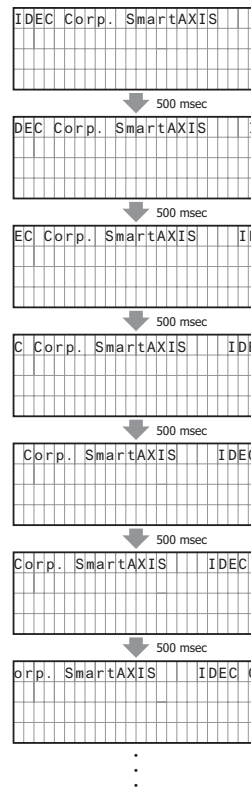

14: THE INTERFACE FB

[Character Set: European, Scroll speed: 500 ms, Scroll unit: 1-dot]

When a text with effect is set to scroll, the text is displayed on the SmartAXIS Pro LCD as follows.

Text: "IDEC Corporation."

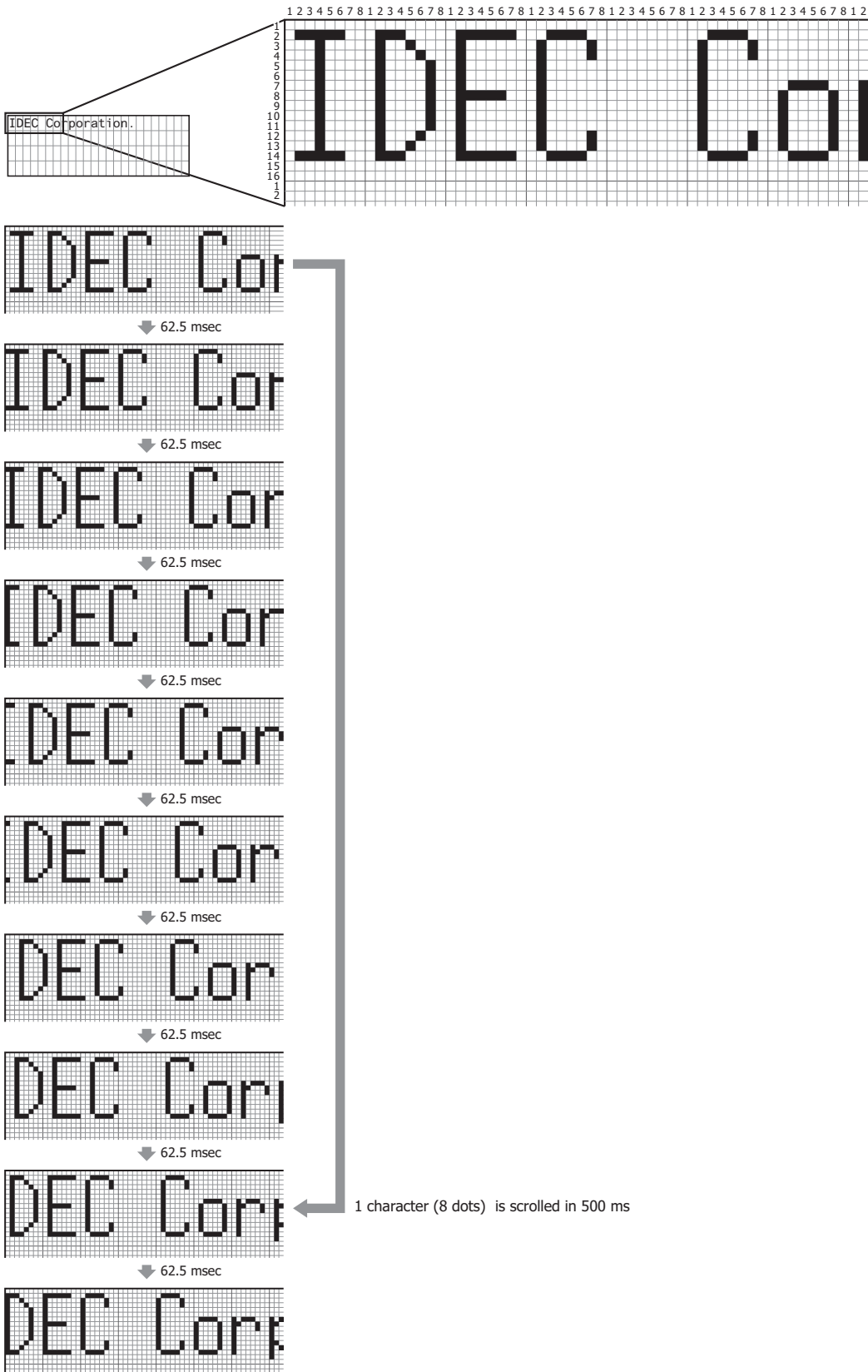

15: THE PULSE FB

The pulse output FB outputs pulses at the specified frequency from the pulse output ports.

PULS (Pulse Output)

The PULS FB outputs pulses at the specified frequency from the specified pulse output ports.

Symbol

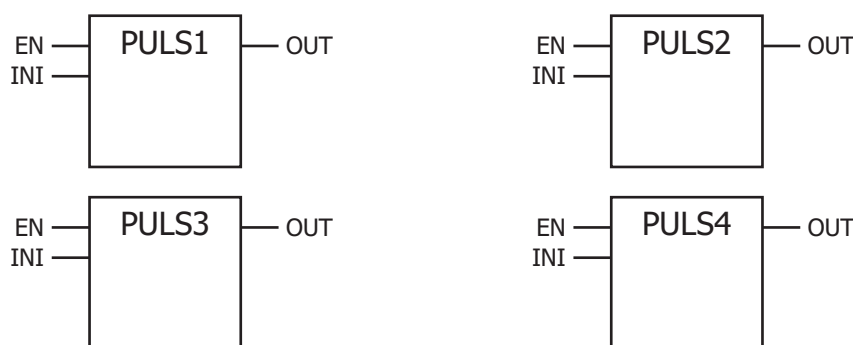

Operation

When the execution input (EN) is on, pulses are output from the pulse output port (n) according to the control register (S1) settings.

The pulse control information (output on/output complete/error) is stored in the specified internal relays as the operation status. When the initialization input (INI) is on, the initial values configured in the **Settings** tab of the editing dialog box in WindLDR are stored in the control registers.

Note: The same pulse output port cannot be shared with more than one PULS FB.

However, the ZRN (Zero Return) FB can be configured with the same pulse output port as the PULS (Pulse Output), PWM (Pulse Width Modulation), RAMP (Ramp Pulse Output), and ARAMP (Advanced Ramp) FBs.

Applicable SmartAXIS

FT1A-12	FT1A-24	FT1A-40	FT1A-48	FT1A Touch
-	-	X (Note)	X	-

Note: These instructions cannot be used with FT1A-H40RC and FT1A-B40RC.

Parameters

Parameter	Function	Range	Description	
Number	B	Block number	B0 to B999	Unique number to identify each function block. The block number is automatically assigned in ascending order from zero. The block number can be changed to a desired number. However, the block numbers already used in any other FBs cannot be used.
Input	EN	Execution input	On/off	When the execution input turns on, the pulse output starts from the pulse output port. When the execution input turns off, the pulse output stops.
	INI	Initialization input*1	On/off	When the initialization input is on, the initial values configured in the Settings tab of the editing dialog box in WindLDR are stored in the control registers.
Output	OUT	Output	-	When the pulse output has completed, the output turns on and keeps on.
Parameters	n	Pulse output Port number	PULS1 to PULS4	Specify the pulse output port number for the PULS FB. The pulse output port differs with PULS1 through PULS4.
	S1	Control register	D0 to D993/ D1000 to D1993	Specify the starting number of the data registers to use with the PULS FB. Starting from the specified data register, 7 consecutive data registers are used.
	D1	Operation status	M0 to M1270	Specify the starting number of the internal relays to use with the PULS FB. Starting from the specified internal relay, 3 consecutive internal relays are used.

*1 The bit device such as an external input (I0 to I155) or an internal relay (M0 to M1277) can be specified. When the initialization input is on, the initial values are written to the data registers with each scan. To initialize the values only one time, use the initialization input in combination with the SOTU (Shot up) FB or the SOTD (Shot down) FB.

15: THE PULSE FB

Valid Devices

Parameter	Function	I	Q	M	R	T	TC	TP	C	CC	CP	B	D	AI	Constant
EN	Execution input	X	X	X	X	X	-	-	X	-	-	X	-	-	-
INI	Initialization input	X		X	-	-	-	-	-	-	-	X	-	-	-
S1	Control register	-	-	-	-	-	-	-	-	-	-	-	X ^{*1}	-	-
D1	Operation status	-	-	X ^{*2}	-	-	-	-	-	-	-	-	-	-	-

*1 Special data registers cannot be designated as S1.

*2 Internal relays can be designated. However, the first digit of the internal relay number must be set to 0. Special internal relays cannot be designated.

Settings

■ Device tab

1. PULS FB selection

Select the PULS FB from PULS1, PULS2, PULS3, and PULS4.

The pulse output, configurable operation mode, and enabling/disabling pulse counting differ depending on PULS FB pulse output port number.

PULS FB	Pulse output	Configurable operation mode	Enable/disable pulse counting
PULS1	Q14	Operation mode 0: 1 Hz to 10 kHz Operation mode 1: 200 Hz to 100 kHz	Pulse counting can be enabled or disabled (Pulse counting range: 1 to 100,000,000)
PULS2	Q15		
PULS3	Q16	Operation mode 0: 1 Hz to 5 kHz	Disable pulse counting
PULS4	Q17		

2. S1: Control Register

S1 specifies the starting number of the data registers to use with the PULS1, PULS2, PULS3, and PULS4 FBs.

Starting from the specified data register, 7 consecutive data registers are used.

The range of available data registers is D0 to D993 and D1000 to D1993.

Storage destination	Function	Setting details		Reference
Starting number+0	Output pulse frequency	PULS1, PULS2	Mode 0: 1 to 10,000 (1 Hz increments) Mode 1: 20 to 10,000 (10 Hz increments)	"6. Output pulse frequency" on page 15-3
		PULS3, PULS4	Mode 0: 1 to 5,000 (1 Hz increments) Mode 1: Cannot be specified	
Starting number+1	Reserved	-		-
Starting number+2	Preset value (upper word) ^{*1}	1 to 100,000,000 pulses		"8. Preset value" on page 15-4
Starting number+3	Preset value (lower word) ^{*1}			
Starting number+4	Current value (upper word) ^{*1}	1 to 100,000,000 pulses		"9. Current value" on page 15-9
Starting number+5	Current value (lower word) ^{*1}			
Starting number+6	Error status	0 to 4		"10. Error status" on page 15-4

*1 The upper and lower data registers switch according to the setting of the 32-bit data storage method.

For details, see Chapter 5 "Special Functions" - "32-bit Data Storage Setting" in the SmartAXIS Pro/Lite User's Manual.

3. INI: Initialization Input

INI specifies the initialization input. When the initialization input is on, the initial values configured in the **Settings** tab of the editing dialog box in WindLDR, are stored in the control registers. The bit device such as an external input (I0 to I155) or an internal relay (M0 to M1277) can be specified.

When the initialization input is on, the initial values are stored in the data registers with each scan. To initialize the values only one time, use the initialization input in combination with the SOTU (Shot up) FB or the SOTD (Shot down) FB.

4. D1: Operation Status

D1 specifies the starting number of the internal relays to use with the PULS FB.

Starting from the specified internal relay, 3 consecutive internal relays are used.

The range of available internal relay is M0 to M1270. The first digit of the internal relay number must be set to 0.

Storage destination	Function	Setting details	
Starting number+0	Pulse output ON	0: Pulse output OFF 1: Pulse output ON	This relay turns on during pulse outputting. This relay turns off when pulse output stops. This relay turns off when the specified number of pulses are output and output completes.
Starting number+1	Pulse output complete ^{*1}	0: Pulse output not complete 1: Pulse output complete	This relay turns on when pulse output has completed. This relay turns off during pulse outputting.
Starting number+2	Overflow	0: None 1: An overflow has occurred	When pulse counting is enabled, this relay turns on when a pulse is output that exceeds the preset value.

*1 The pulse output complete on/off state is reflected in the PULS FB output (OUT). However, when the execution input is off, the PULS FB output (OUT) is off.

Parameter tab

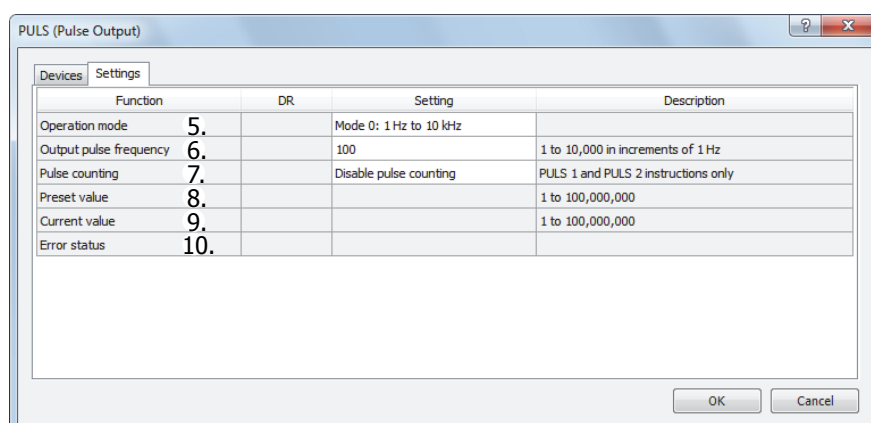

5. Operation mode

Select the frequency range to output from two operation modes. PULS3 and PULS4 only support operation mode 0.

Operation mode	Supported PULS FB			
	PULS1	PULS2	PULS3	PULS4
0: 1 Hz to 10 kHz (1 Hz increments) ^{*1} (PULS1, PULS2) 1 Hz to 5 kHz (1 Hz increments) ^{*1} (PULS3, PULS4)	X	X	X	X
1: 200 Hz to 100 kHz (10 Hz increments) ^{*1}	X	X	–	–

*1 The output frequency error is within $\pm 5\%$.

6. Output pulse frequency

PULS1, PULS2: Mode 0: Set between 1 Hz and 10 kHz in 1 Hz increments. The output frequency error is within $\pm 5\%$.

Mode 1: Set between 200 Hz and 100 kHz in 10 Hz increments. The output frequency error is within $\pm 5\%$.

PULS3, PULS4: Set between 1 Hz and 5 kHz in 1 Hz increments. The output frequency error is within $\pm 5\%$.

7. Pulse counting

Specify enabling or disabling pulse counting.

Pulse counting		Supported PULS FB			
		PULS1	PULS2	PULS3	PULS4
0: Disable pulse counting	Pulses are continuously output while the execution input is on.	X	X	X	X
1: Enable pulse counting	The number of pulses specified by the preset value are output.	X	X	–	–

15: THE PULSE FB

8. Preset value

For **Enable pulse counting**, specify the number of pulses to output.

9. Current value

The number of pulses that were output is stored in this data register. The current value is updated when the PULS FB is executed at each scan.

10. Error status

If a configuration error occurs when the PULS FB execution input turns from off to on, M8004 (user program execution error) is turned on and the error code is stored in this register.

Error code	Content	Details	
0	Normal	-	
2	Pulse frequency designation error	PULS1, PULS2	The pulse frequency was not set between 1 and 10,000 in operation mode 0.
		PULS3, PULS4	The pulse frequency was not set between 20 and 10,000 in operation mode 1.
4	Preset value designation error	The preset value was not set between 1 and 100,000,000.	

Operation example

PULS1 FB (pulse counting enabled) timing chart

For PULS1 FB, the external input I0 is connected to EN, the internal relay M0 is connected to INI, D200 is specified to S1, the internal relay M50 is specified to D1.

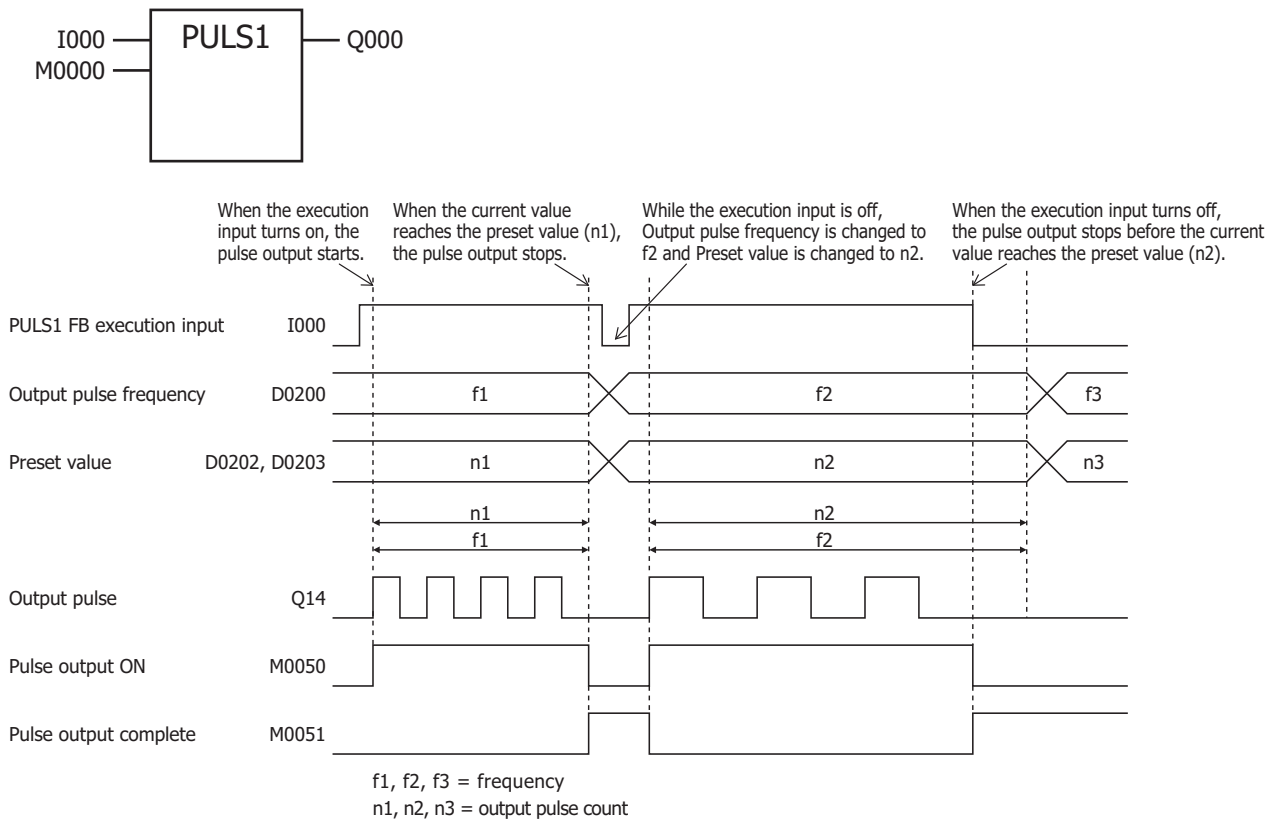

- When the PULS1 FB execution input (I0) turns from off to on, M50 turns on and pulses are output with the frequency configured by D200.
- When the number of pulses configured by D202 and D203 are output, pulse output stops.
- If the value of D200 is changed during pulse output, pulses are output with the frequency based on the changed value. The interval (period) for changing the pulse frequency has to be sufficiently long as compared to the output pulse frequency.
- When the PULS1 FB execution input (I0) changes from on to off, M50 turns off and M51 turns on.
- The state of the initialization input (M0) are not reflected while the PULS1 FB execution input (I0) is on. If you wish to initialize the data registers with the initialization input, turn the initialization input on after turning off the execution input.

PULS2 FB (pulse counting disabled) timing chart

For PULS2 FB, the external input I0 is connected to EN, the internal relay M0 is connected to INI, D100 is specified to S1, the internal relay M200 is specified to D1.

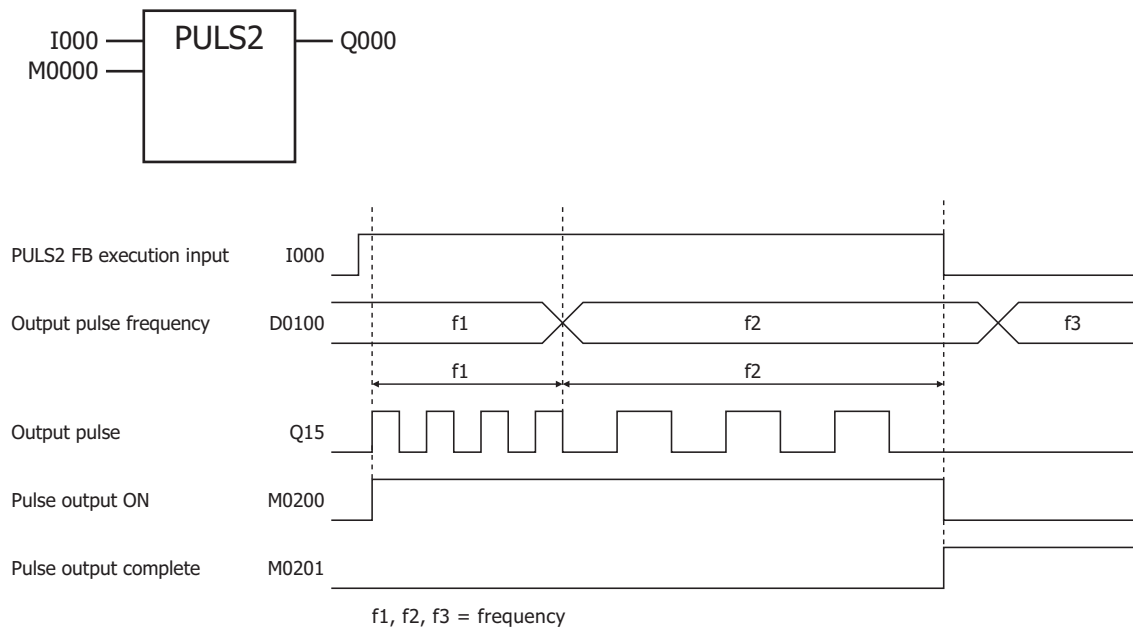

- When the PULS2 FB execution input (I0) turns from off to on, M200 turns on and pulses are output with the frequency configured by D100.
- If the value of D100 is changed during pulse output, pulses are output with the frequency based on that value. The interval (period) for changing the pulse frequency has to be sufficiently long as compared to the output pulse frequency.
- When the PULS2 FB execution input turns from on to off, M200 turns off and M201 turns on.
- The state of the initialization input (M0) are not reflected while the PULS2 FB execution input is on. If you wish to initialize the data registers with the initialization input, turn the initialization input on after turning off the execution input.

PWM (Pulse Width Modulation)

The PWM FB outputs pulses at the specified frequency and duty cycle from the output port.

Symbol

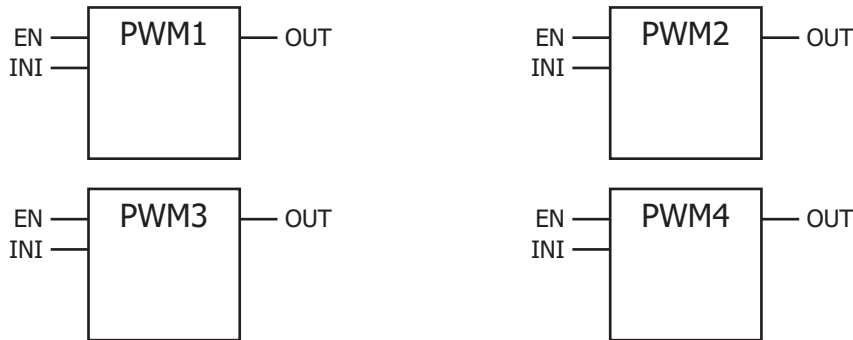

Operation

When the execution input (EN) is on, pulses are output from the pulse output port (n) according to the control register (S1) settings.

When pulse output completes, the output (OUT) turns on.

The pulse control information (output on/output complete/error) is stored in the specified internal relays as the operation status.

When the initialization input (INI) is on, the initial values configured in the **Settings** tab of the editing dialog box in WindLDR are stored in the control registers.

Note: The same pulse output port cannot be shared with more than one PWM FB.

However, the ZRN (Zero Return) FB can be configured with the same pulse output port as the PULS (Pulse Output), PWM (Pulse Width Modulation), RAMP (Ramp Pulse Output), and ARAMP (Advanced Ramp) FBs.

Applicable SmartAXIS

FT1A-12	FT1A-24	FT1A-40	FT1A-48	FT1A Touch
-	-	X (Note)	X	-

Note: These instructions cannot be used with FT1A-H40RC and FT1A-B40RC.

Parameters

Parameter	Function	Range	Description	
Number	B	Block number	B0 to B999	Unique number to identify each function block. The block number is automatically assigned in ascending order from zero. The block number can be changed to a desired number. However, the block numbers already used in any other FBs cannot be used.
Input	EN	Execution input	On/off	When the execution input is on, pulses are output from the pulse output port according to the control register (S1) settings. When the execution input turns off, the pulse output stops.
	INI	Initialization input*1	On/off	When the initialization input is on, the initial values configured in the Settings tab of the editing dialog box in WindLDR are stored in the control registers.
Output	OUT	Output	-	When the pulse output has completed, the output turns on and keeps on.
Parameters	n	Pulse output Port number	PWM1 to PWM4	Specify the pulse output port number for the PWM FB. The pulse output port differs with PWM1 through PWM4.
	S1	Control register	D0 to D993/ D1000 to D1993	Specify the starting number of the data registers to use with the PWM FB. Starting from the specified data register, 7 consecutive data registers are used.
	D1	Operation status	M0 to M1270	Specify the starting number of the internal relays to use with the PWM FB. Starting from the specified internal relay, 3 consecutive internal relays are used.

*1 The bit device such as an external input (I0 to I155) or an internal relay (M0 to M1277) can be specified. When the initialization input is on, the initial values are written to the data registers with each scan. To initialize the values only one time, use the initialization input in combination with the SOTU (Shot up) FB or the SOTD (Shot down) FB.

Valid Devices

Parameter	Function	I	Q	M	R	T	TC	TP	C	CC	CP	B	D	AI	Constant
EN	Execution input	X	X	X	X	X	-	-	X	-	-	X	-	-	-
INI	Initialization input	X	-	X	-	-	-	-	-	-	-	X	-	-	-
S1	Control register	-	-	-	-	-	-	-	-	-	-	-	X ^{*1}	-	-
S2	Operation status	-	-	X ^{*2}	-	-	-	-	-	-	-	-	-	-	-

*1 Special data registers cannot be used.

*2 Internal relays can be used. However, the first digit of the internal relay number must be set to 0. Special internal relays cannot be used.

Settings

■ **Device tab**

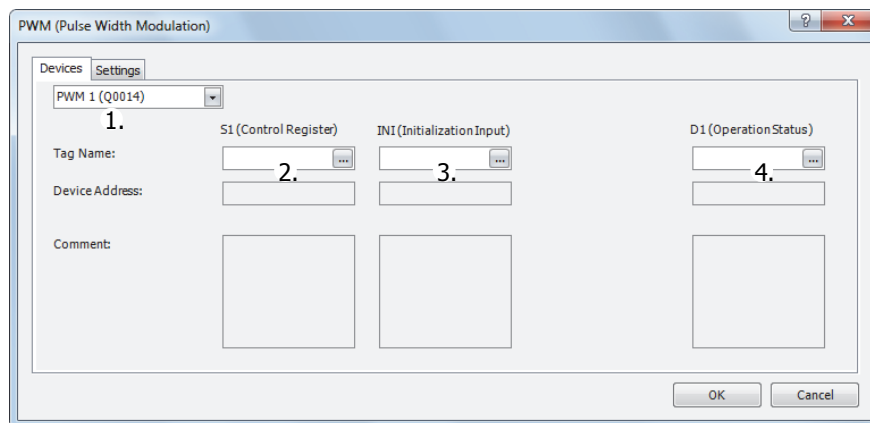

1. PWM FB selection

Select the PWM FB from PWM1, PWM2, PWM3, or PWM4.

The pulse output, pulse duty cycle (ON ratio), configurable operation mode, and enabling/disabling pulse counting differ depending on PWM FB pulse output port number.

PULS FB	Pulse output	Configurable operation mode	Enable/disable pulse counting
PULS1	Q14	1 to 100% (1% increments)	Pulse counting can be enabled or disabled (Pulse counting range: 1 to 100,000,000)
PULS2	Q15		
PULS3	Q16	1 to 100% (1 to 50 Hz is 1% increments, 51 to 1,000 Hz is pulse frequency/50% increments)	Disable pulse counting
PULS4	Q17		

2. S1: Control Register

S1 specifies the starting number of the data registers to use with the PWM1, PWM2, PWM3, and PWM4 FBs.

Starting from the specified data register, 7 consecutive data registers are used.

The range of available data registers is D0 to D993 and D1000 to D1993.

Storage destination	Function	Setting details	Reference
Starting number+0	Output pulse frequency	1 to 1,000 (1 Hz increments)	"5. Output pulse frequency" on page 15-8
Starting number+1	Pulse duty cycle (ON ratio)	1 to 100%	"6. Pulse width ratio" on page 15-8
Starting number+2	Preset value (upper word) ^{*1}	1 to 100,000,000 pulses	"8. Preset value" on page 15-9
Starting number+3	Preset value (lower word) ^{*1}		
Starting number+4	Current value (upper word) ^{*1}	1 to 100,000,000 pulses	"9. Current value" on page 15-9
Starting number+5	Current value (lower word) ^{*1}		
Starting number+6	Error status	0 to 4	"10. Error status" on page 15-9

*1 The upper and lower data registers switch according to the setting of the 32-bit data storage method.

For details, see Chapter 5 "Special Functions" - "32-bit Data Storage Setting" in the SmartAXIS Pro/Lite User's Manual.

15: THE PULSE FB

3. INI: Initialization Input

INI specifies the initialization input. When the initialization input is on, the initial values configured in the **Settings** tab of the editing dialog box in WindLDR are stored in the control registers. The bit device such as an external input (I0 to I155) or an internal relay (M0 to M1277) can be specified.

When the initialization input is on, the initial values are written to the data registers with each scan. To initialize the values only one time, use the initialization input in combination with the SOTU (Shot up) FB or the SOTD (Shot down) FB.

4. D1: Operation Status

D1 specifies the starting number of the internal relays to use with the PWM FB.

Starting from the specified internal relay, 3 consecutive internal relays are used.

The range of available internal relay numbers is M0 to M1270. The first digit of the internal relay number must be set to 0.

Storage destination	Function	Setting details	
Starting number+0	Pulse output ON	0: Pulse output OFF 1: Pulse output ON	This relay turns on during pulse outputting. This relay turns off when pulse output stops. This relay turns off when the specified number of pulses are output and output completes.
Starting number+1	Pulse output complete*1	0: Pulse output not complete 1: Pulse output complete	This relay turns on when pulse output has completed. This relay turns off during pulse outputting.
Starting number+2	Overflow	0: None 1: An overflow has occurred	When pulse counting is enabled, this relay turns on in case a pulse is output that exceeds the preset value.

*1 The pulse output complete on/off state is reflected in the PWM FB output (OUT). However, when the execution input is off, the PWM FB output (OUT) is off.

Parameter tab

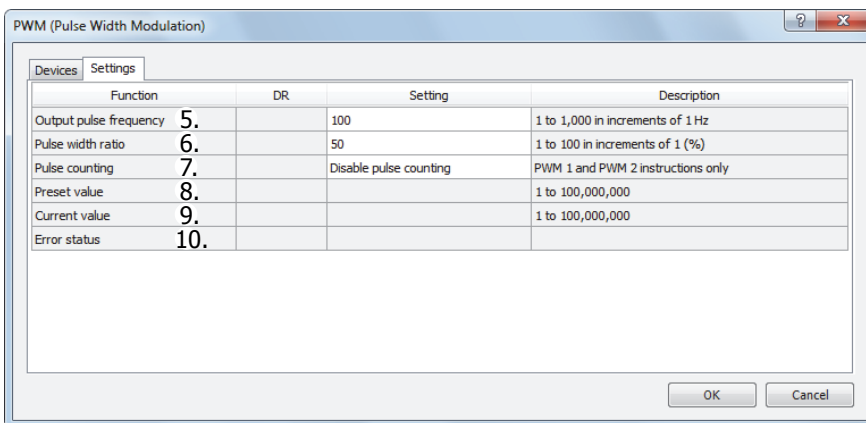

5. Output pulse frequency

Set the frequency for the output pulse from 1 Hz to 1,000 Hz in 1 Hz increments.

The output frequency error is within $\pm 5\%$.

6. Pulse width ratio

Specify the ON ratio (duty cycle) for the output pulse.

The duty cycle can be set for the output frequency in 1% increments.

The duty cycle can be set for the output frequency in 1% increments from 1 Hz to 50 Hz, but from 51 Hz to 1,000 Hz, the increments for the duty cycle that can be specified change depending on the output frequency. The increment becomes (pulse frequency/50)%.

For example, when 51 Hz is specified for the pulse frequency, $51/50 = 2$ (rounded up), so the increment is 2%. When 1,000 Hz is specified for the pulse frequency, $1000/50 = 20$, so the increment is 20%. For 2% increments, a value from 1 to 2 set for **Pulse width ratio** is handled as 2%, a value from 3 to 4 is handled as 4%. For 20% increments a value from, 1 to 20 is handled as 20%, a value from 21 to 40 is handled as 40%.

7. Pulse counting

Specify enabling or disabling pulse counting.

Operation mode		Supported PULS FB			
		PULS1	PULS2	PULS3	PULS4
0: Disable pulse counting	Pulses are continuously output while the execution input is on.	X	X	X	X
1: Enable pulse counting	The number of pulses specified by the preset value are output.	X	X		

8. Preset value

For **Enable pulse counting**, specify the number of pulses to output.

9. Current value

The number of pulses that were output is stored in this data register. The current value is updated when the PWM FB is executed at each scan.

10. Error status

If a configuration error occurs when the PWM FB execution input turns from off to on, M8004 (user program execution error) is turned on and the error code is stored in this register.

Error code	Content	Details
0	Normal	-
1	Pulse frequency designation error	The pulse frequency was not set between 1 and 1,000.
2	Pulse width ratio designation error	The pulse width ratio was not set between 1 and 100.
4	Preset value designation error	The preset value was not set between 1 and 100,000,000.

Operation example

PWM1 FB (pulse counting enabled) timing chart

For PWM1 FB, the external input I0 is connected to EN, the internal relay M0 is connected to INI, D201 is specified to S1, the internal relay M50 is specified to D1.

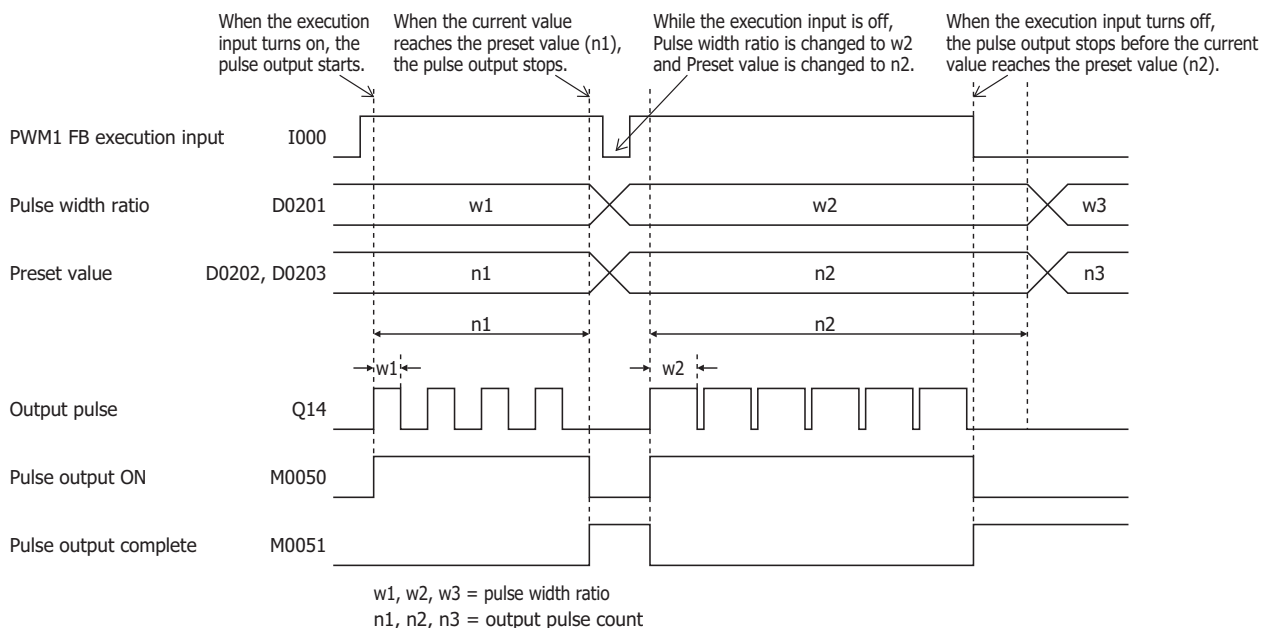
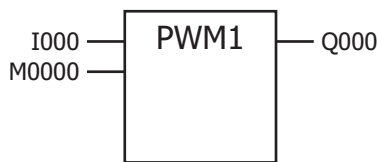

- When the PWM1 FB execution input (I0) turns from off to on, M50 turns on and pulses are output with the width ratio configured by D201.
- When the number of pulses configured by D202 and D203 are output, pulse output stops.
- If the value of D201 is changed during pulse output, pulses are output with the width ratio based on the changed value. The interval (period) for changing the width ratio has to be sufficiently long as compared to the output pulse frequency.
- When the PWM1 FB execution input changes from on to off, M50 turns off, and M051 turns on at the same time as that.
- The state of the initialization input (M0) are not reflected while the PWM1 FB execution input is on. If you wish to initialize the data registers with the initialization input, turn the initialization input on after turning off the execution input.

PWM2 FB (pulse counting disabled) timing chart

For PWM2 FB, the external input I0 is connected to EN, the internal relay M0 is connected to INI, D100 is specified to S1, the internal relay M200 is specified to D1.

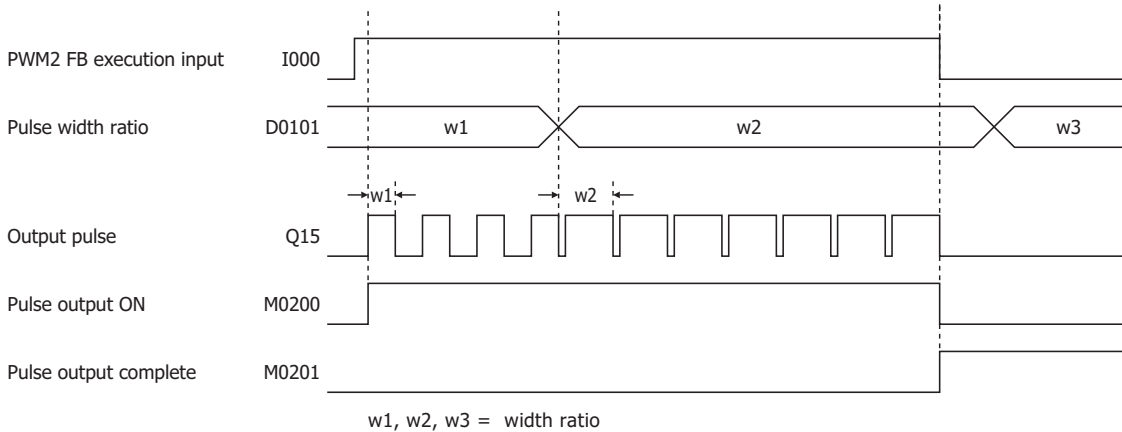
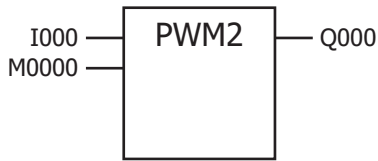

w1, w2, w3 = width ratio

- When the PWM2 FB execution input (I0) turns from off to on, M200 turns on and pulses are output with the width ratio configured by D101.
- If the value of D101 is changed during pulse output, pulses are output with the width ratio based on that value. The interval (period) for changing the width ratio has to be sufficiently long as compared to the output pulse frequency.
- When the PWM2 FB execution input turns from on to off, M200 turns off and M201 turns on.
- The state of the initialization input (M0) are not reflected while the PWM2 FB execution input is on. If you wish to initialize the data registers with the initialization input, turn the initialization input on after turning off the execution input.

RAMP (Ramp Pulse Output)

The RAMP FB outputs pulses with a frequency change function.

Symbol



Operation

When the execution input (EN) turns on, pulses of the specified initial pulse frequency are output from the pulse output port, and then the pulse frequency is increased linearly until it reaches the steady pulse frequency.

It remains constant at this frequency for some time, and then, the pulse frequency is decreased linearly until the pulse count reaches the specified preset value, and pulse output is stopped.

When the initialization input (INI) is on, the initial values configured in the **Settings** tab of the editing dialog box in WindLDR are stored in the control registers.

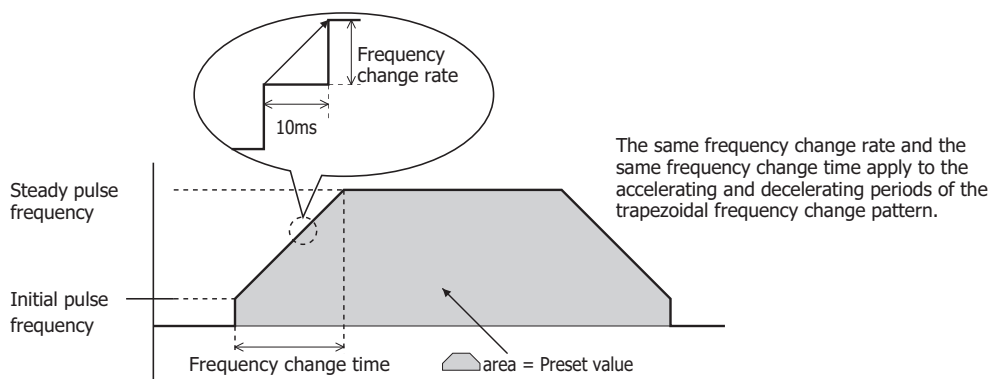

Note: The same pulse output port cannot be shared with more than one RAMP FB.

However, the ZRN (Zero Return) FB can be configured with the same pulse output port as the PULS (Pulse Output), PWM (Pulse Width Modulation), RAMP (Ramp Pulse Output), and ARAMP (Advanced Ramp) FBs.

Applicable SmartAXIS

FT1A-12	FT1A-24	FT1A-40	FT1A-48	FT1A Touch
-	-	X (Note)	X	-

Note: These instructions cannot be used with FT1A-H40RC and FT1A-B40RC.

Parameters

Parameter	Function	Range	Description	
Number	B	Block number	B0 to B999	Unique number to identify each function block. The block number is automatically assigned in ascending order from zero. The block number can be changed to a desired number. However, the block numbers already used in any other FBs cannot be used.
Input	EN	Execution input	On/off	When the execution input is on, pulses are output from the pulse output port according to the control register (S1) settings. When the execution input turns off, the pulse output stops.
	INI	Initialization input ^{*1}	On/off	When the initialization input is on, the initial values configured in the Settings tab of the editing dialog box in WindLDR are stored in the control registers.
	DIR	Control direction input ^{*2}	On/off	If reversible control is enabled, when the control direction input is on, reverse operation. When the control direction input is off, forward operation. When unconnected, handled as off.
Output	OUT	Output	-	When the pulse output has completed, the output turns on and keeps on.
Parameters	n	Pulse output port number	RAMP1, RAMP2	Specify the pulse output port number for the RAMP FB. The pulse output port differs with RAMP1 and RAMP2.
	S1	Control register	D0 to D991/ D1000 to D1991	Specify the starting number of the data registers to use with the RAMP FB. Starting from the specified data register, 9 consecutive data registers are used.
	D1	Operation status	M0 to M1270	Specify the starting number of the internal relays to use with the RAMP FB. Starting from the specified internal relay, 4 consecutive internal relays are used.

*1 The bit device such as an external input (I0 to I155) or an internal relay (M0 to M1277) can be specified. When the initialization input is on, the initial values are written to the data registers with each scan. To initialize the values only one time, use the initialization input in combination with the SOTU (Shot up) FB or the SOTD (Shot down) FB.

*2 When reversible control is disabled, the control direction input is disabled.

15: THE PULSE FB

Valid Devices

Parameter	Function	I	Q	M	R	T	TC	TP	C	CC	CP	B	D	AI	Constant
EN	Execution input	X	X	X	X	X	-	-	X	-	-	X	-	-	-
INI	Initialization input	X	-	X	-	-	-	-	-	-	-	X	-	-	-
DIR	Control direction input	X	X	X	X	X	-	-	X	-	-	X	-	-	-
S1	Control register	-	-	-	-	-	-	-	-	-	-	-	X ^{*1}	-	-
D1	Operation status	-	-	X ^{*2}	-	-	-	-	-	-	-	-	-	-	-

*1 Special data registers cannot be used.

*2 Internal relays can be used. However, the first digit of the internal relay number must be set to 0. Special internal relays cannot be used.

Settings

■ Device tab

1. RAMP FB selection

Select the RAMP FB from RAMP1 or RAMP2.

The reversible control mode that can be selected differs according to the RAMP FB.

For the combinations of RAMP FB pulse output port numbers and the reversible control mode, see "9. Reversible control enable" on page 15-14.

2. S1: Control Register

S1 specifies the starting number of the data registers to use with the RAMP1 and RAMP2 FBs.

Starting from the specified data register, 9 consecutive data registers are used.

The range of available data registers is D0 to D991 and D1000 to D1991.

Storage destination	Function	Setting details	Reference
Starting number+0	Steady pulse frequency	Operation mode 0: 1 to 10,000 (1 Hz increments) Operation mode 1: 20 to 10,000 (10 Hz increments)	"6. Steady pulse frequency" on page 15-13
Starting number+1	Initial pulse frequency	Operation mode 0: 1 to 10,000 (1 Hz increments) Operation mode 1: 20 to 10,000 (10 Hz increments)	"7. Initial pulse frequency" on page 15-14
Starting number+2	Frequency change time	10 to 10,000 ms	"8. Frequency change time" on page 15-14
Starting number+3	Control direction ^{*1}	0: Forward 1: Reverse	"10. Control direction" on page 15-14
Starting number+4	Preset value (upper word) ^{*2}	1 to 100,000,000 pulses	"11. Preset value" on page 15-14
Starting number+5	Preset value (lower word) ^{*2}		
Starting number+6	Current value (upper word) ^{*2}	1 to 100,000,000 pulses	"12. Current value" on page 15-14
Starting number+7	Current value (lower word) ^{*2}		
Starting number+8	Error status	0 to 9	"13. Error status" on page 15-15

*1 Stores the on/off state of the control direction input. This data register is read-only. The reversible control value (0/1) cannot be changed using the data register.

*2 The upper and lower data registers switch according to the setting of the 32-bit data storage method. For details, see Chapter 5 "Special Functions" - "32-bit Data Storage Setting" in the SmartAXIS Pro/Lite User's Manual.

3. INI: Initialization Input

INI specifies the initialization input. When the initialization input is on, the initial values configured in the **Settings** tab of the editing dialog box in WindLDR are stored in the control registers. The bit device such as an external input (I0 to I155) or an internal relay (M0 to M1277) can be specified.

When the initialization input is on, the initial values are stored in the data registers with each scan. To initialize the values only one time, use the initialization input in combination with the SOTU (Shot up) FB or the SOTD (Shot down) FB.

4. D1: Operation Status

D1 specifies the starting number of the internal relays to use with the RAMP FB.

Starting from the specified internal relay, 4 consecutive internal relays are used.

The range of available internal relay numbers is M0 to M1270. The first digit of the internal relay number must be set to 0.

Storage destination	Function	Setting details	
Starting number+0	Pulse output ON	0: Pulse output OFF 1: Pulse output ON	This relay remains on during pulse output. This relay turns off when pulse output stops. This relay turns off when the specified number of pulses are output and output completes.
Starting number+1	Pulse output complete ^{*1}	0: Pulse output not complete 1: Pulse output complete	This relay turns on when pulse output has completed. This relay is off during pulse output.
Starting number+2	Pulse output state	0: Steady pulse output 1: Changing output pulse frequency	This relay is off when the pulse output frequency is steady. This relay is on when the pulse output frequency is changing.
Starting number+3	Overflow	0: Overflow not occurred 1: Overflow occurred	When counting is enabled, this relay turns on when pulses are output more than the configured preset value.

*1 The pulse output complete on/off state is reflected in the RAMP FB output (OUT). However, when the execution input is off, the RAMP FB output (OUT) is off.

■ Parameter tab

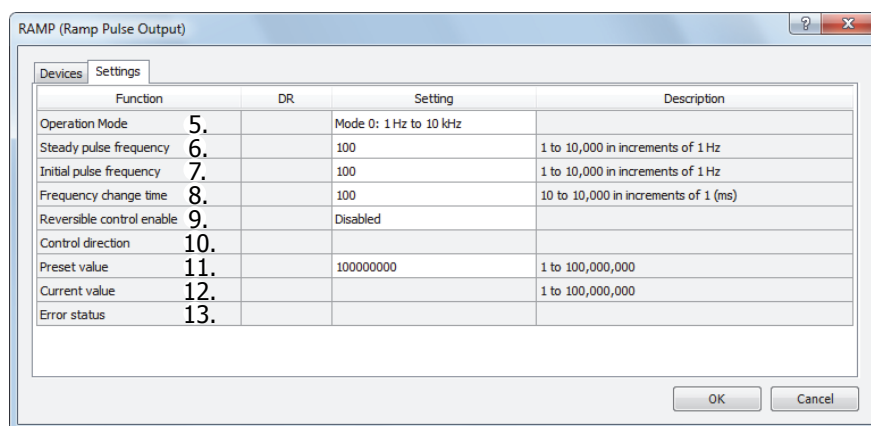

5. Operation Mode

Select the output frequency range from following operation modes. Select the operation mode according to the steady pulse frequency and the initial pulse frequency used.

Operation mode	
0:	1 Hz to 10 kHz (1 Hz increments) ^{*1}
1:	200 Hz to 100 kHz (10 Hz increments) ^{*1}

*1 The output frequency error is within $\pm 5\%$.

6. Steady pulse frequency

This setting specifies the steady pulse frequency after the pulse frequency finishes increasing.

For operation mode 0, set the frequency in the range of 1 to 10,000 (1 Hz increments).

For operation mode 1, set the frequency in the range of 20 to 10,000 (10 Hz increments).

15: THE PULSE FB

7. Initial pulse frequency

Specify the frequency when pulse output starts.

For operation mode 0, set the frequency in the range of 1 to 10,000 (1 Hz increments).

For operation mode 1, set the frequency in the range of 20 to 10,000 (10 Hz increments).

8. Frequency change time

Specify the time to increase and decrease the pulse frequency.

Set the time in the range of 10 to 10,000 ms in 10 ms increments. The first digit of the setting is ignored.

9. Reversible control enable

This setting enables or disables reversible control and selects the reversible control method from the following reversible control modes.

Reversible control enable	
0:	Disable
1:	Single-pulse output
2:	Dual-pulse output

The details of reversible control mode are as follows.

Disable	Select this option when using pulse output in a single direction. Pulse A and pulse B can be used independently.	
Reversible control Single-pulse output mode	Pulse A or B is used as pulse output. On/off state of pulse C is used as reversible control.	
Reversible control Dual-pulse output mode	Pulse A is used as forward pulse (CW) output. Pulse B is used as reverse pulse (CCW) output.	

The ports used on the SmartAXIS differ according to the combination of the RAMP FB pulse output port number, the reversible control enable setting, and the I/O type of SmartAXIS.

RAMP FB	Reversible control enable	Port used			
		40-I/O type		48-I/O type	
		Pulse output port	Control direction	Pulse output port	Control direction
RAMP1	Disable	Q14(A)	–	Q14(A)	–
	Single-pulse output	Q14(A)	Q16(C) ^{*1 *2}	Q14(A)	Q12(C) ^{*2}
	Dual-pulse output ^{*3}	Q14(A)	Q15(B) ^{*3}	Q14(A)	Q15(B) ^{*3}
RAMP2	Disable	Q15(B)	–	Q15(B)	–
	Single-pulse output	Q15(B)	Q17(C) ^{*1 *2}	Q15(B)	Q13(C) ^{*2}
	Dual-pulse mode cannot be used.	–	–	–	–

*1 When using single-pulse output mode on the 40-I/O type, Q16 or Q17 is used as the control direction port. Therefore, PULS3, PWM3, or PULS4, PWM4 cannot be used.

*2 Outputs the on/off state of the control direction input.

*3 When using RAMP1 in dual-pulse output mode, RAMP2 or ARAMP2 cannot be used.

10. Control direction

Stores the on/off state of the control direction input.

This data register is read-only. The control direction value (0/1) cannot be changed using the data register.

11. Preset value

This setting configures the total number of output pulses in the range of 1 to 100,000,000.

12. Current value

The number of pulses output from the pulse output port is stored in this data register.

The current value is updated when the RAMP FB is executed at each scan.

13. Error status

If a configuration error occurs when the RAMP FB execution input turns from off to on, M8004 (user program execution error) is turned on and the error code is stored in this register.

Error code	Status	
0	Normal	–
2	Initial pulse frequency designation error	The initial pulse frequency was not set between 1 and 10,000 in operation mode 0. The initial pulse frequency was not set between 20 and 10,000 in operation mode 1.
3	Preset value designation error	The preset value was not set between 1 to 100,000,000.
4	Steady pulse frequency designation error	The steady pulse frequency was not set between 1 and 10,000 in operation mode 0. The steady pulse frequency was not set between 20 and 10,000 in operation mode 1.
5	Frequency change time designation error	The frequency change time was not set between 10 and 10,000.
8	Exceeded pulse number error	The number of frequency change pulses exceed the preset total number of output pulses* ¹ .
9	The initial pulse frequency was set to the same frequency as the steady pulse frequency or it was set to a value larger than the steady pulse frequency* ² .	

*1 The number of pulses in the frequency change area calculated by the initial pulse frequency, steady pulse frequency, and frequency change time has exceeded the preset total number of output pulses. Adjust the settings by decreasing the steady or initial pulse frequency or by shortening the frequency change time.

*2 Set the initial pulse frequency so that it is lower than the steady pulse frequency.

Operation example

RAMP1 FB (reversible control disabled) timing chart

For RAMP1 FB, the external input I0 is connected to EN, the internal relay M0 is connected to INI, D200 is specified to S1, the internal relay M50 is specified to D1.

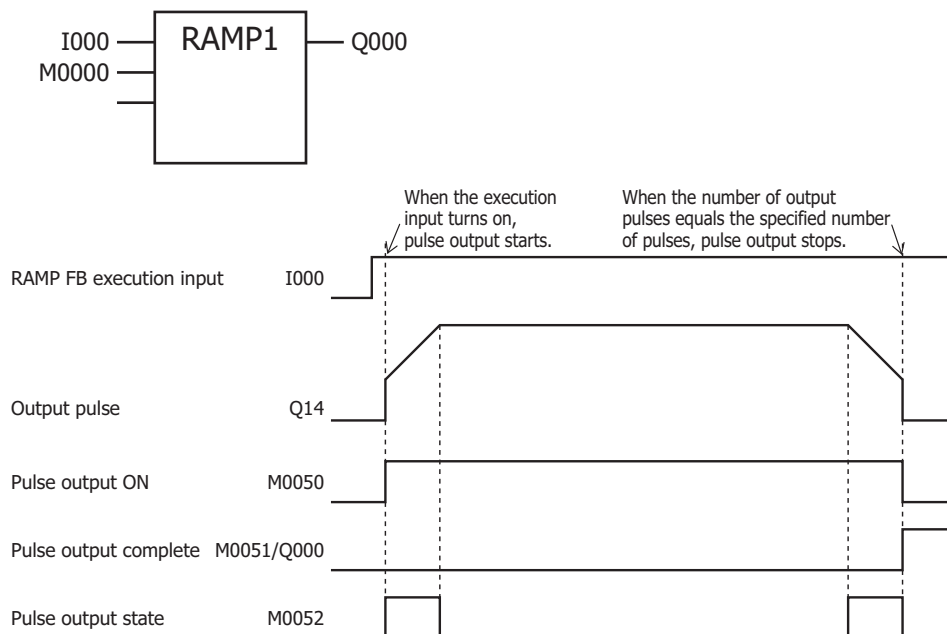

- When the RAMP FB execution input (I0) is on, pulses are output according to the settings configured by the control registers.
- M50 is on during pulse output. M52 is on while the pulse frequency is increasing or decreasing.
- Pulses are output so that the pulse frequency reaches the steady pulse frequency from the initial pulse frequency in the frequency change time. The pulse frequency increases or decreases every 10 ms during the frequency change time.
- Pulse output stops when the number of pulses configured by the preset value are output. At this time, M50 turns off, M51 turns on, and Q0 turns on.
- If the RAMP1 FB execution input (I0) turns off during pulse output, pulse output stops immediately. If the execution input turns on again, the pulse count is reset and the operation starts from the beginning.
- Even if the contents of the data registers are changed during pulse output, the change is not reflected in pulse output operation. The changed content is reflected the next time the RAMP1 FB execution input turns from off to on.
- The state of the initialization input (M0) are not reflected while the RAMP1 FB execution input (I0) is on. If you wish to initialize the data registers with the initialization input, turn the initialization input on after turning off the execution input.

RAMP1 FB (reversible control enabled, single-pulse output mode) timing chart

For RAMP1 FB, the external input I0 is connected to EN, the internal relay M0 is connected to INI, the internal relay M10 is connected to DIR D200 is specified to S1, the internal relay M50 is specified to D1.

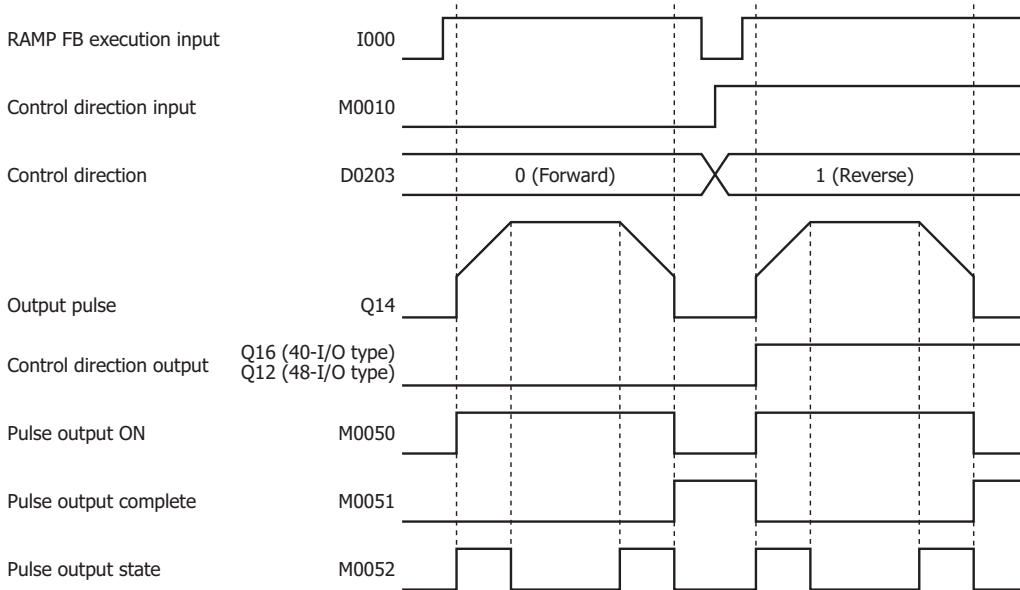
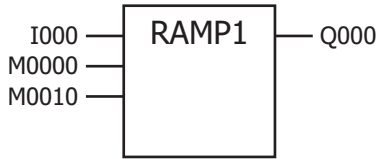

- When the RAMP FB execution input (I0) is on, pulses are output according to the settings configured by the control registers. The control direction is output to Q16 or Q12 according to the on/off state of the control direction input (M10).
- When pulse output starts, M50 turns on. M52 is on while the pulse frequency is increasing or decreasing.
- The pulses frequency increases according to the frequency change time every 10 ms until it reaches the steady pulse frequency from the initial pulse frequency.
- When the configured number of pulses are output, the pulse output stops. In this situation, M50 turns off, M51 turns on, and Q0 turns on.
- If the RAMP1 FB execution input (I0) turns off during pulse output, pulse output stops. If the execution input turns on again, the operation starts from the beginning.
- Even if the contents of the data registers are changed during pulse output, the change is not reflected in pulse output operation. The changed content is reflected the next time the RAMP1 FB execution input turns from off to on.
- The state of the initialization input (M0) are not reflected while the RAMP1 FB execution input (I0) is on. If you wish to initialize the data registers with the initialization input, turn the initialization input on after turning off the execution input.

RAMP1 FB (reversible control enabled, dual-pulse output mode) timing chart

For RAMP1 FB, the external input I0 is connected to EN, the internal relay M0 is connected to INI, the internal relay M10 is connected to DIR D200 is specified to S1, the internal relay M50 is specified to D1.

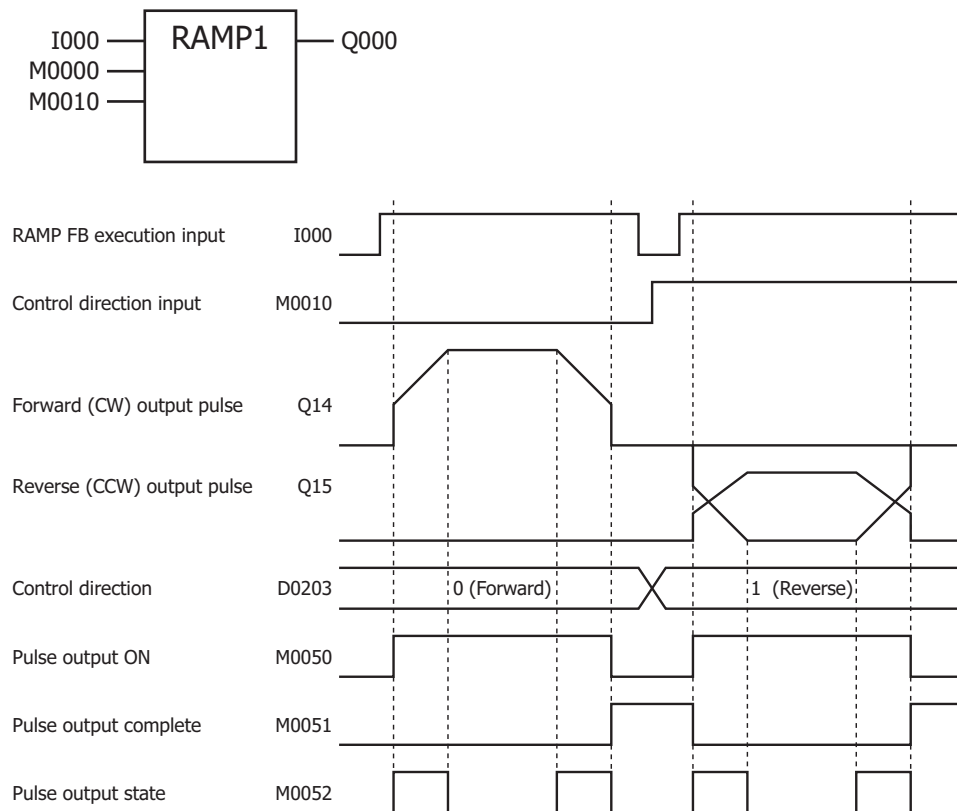

- When the RAMP1 FB execution input (I0) is on, pulses are output from Q14 or Q15 according to the settings configured by the data registers.
- When pulse output starts, M50 turns on. M52 is on while the pulse frequency is increasing or decreasing.
- The pulses frequency increases according to the frequency change time every 10 ms until it reaches the steady pulse frequency from the initial pulse frequency.
- When the configured number of pulses are output, the pulse output stops. In this situation, M50 turns off, M51 turns on, and Q0 turns on.
- If the RAMP1 FB execution input (I0) turns off during pulse output, pulse output stops. If the execution input turns on again, the operation starts from the beginning.
- Even if the contents of the data registers are changed during pulse output, the change is not reflected in pulse output operation. The changed content is reflected the next time the RAMP1 FB execution input turns from off to on.
- The state of the initialization input (M0) are not reflected while the RAMP1 FB execution input (I0) is on. If you wish to initialize the data registers with the initialization input, turn the initialization input on after turning off the execution input.

15: THE PULSE FB

Sample program

[To output 48,000 pulses with the frequency change function (reversible control disabled) from Q14]

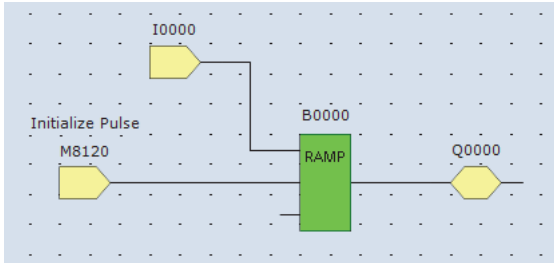

- When the SmartAXIS changes from STOP to RUN, the initialize input (M8120) turns on.
- When the RAMP FB execution input (I0) turns on, pulse output starts

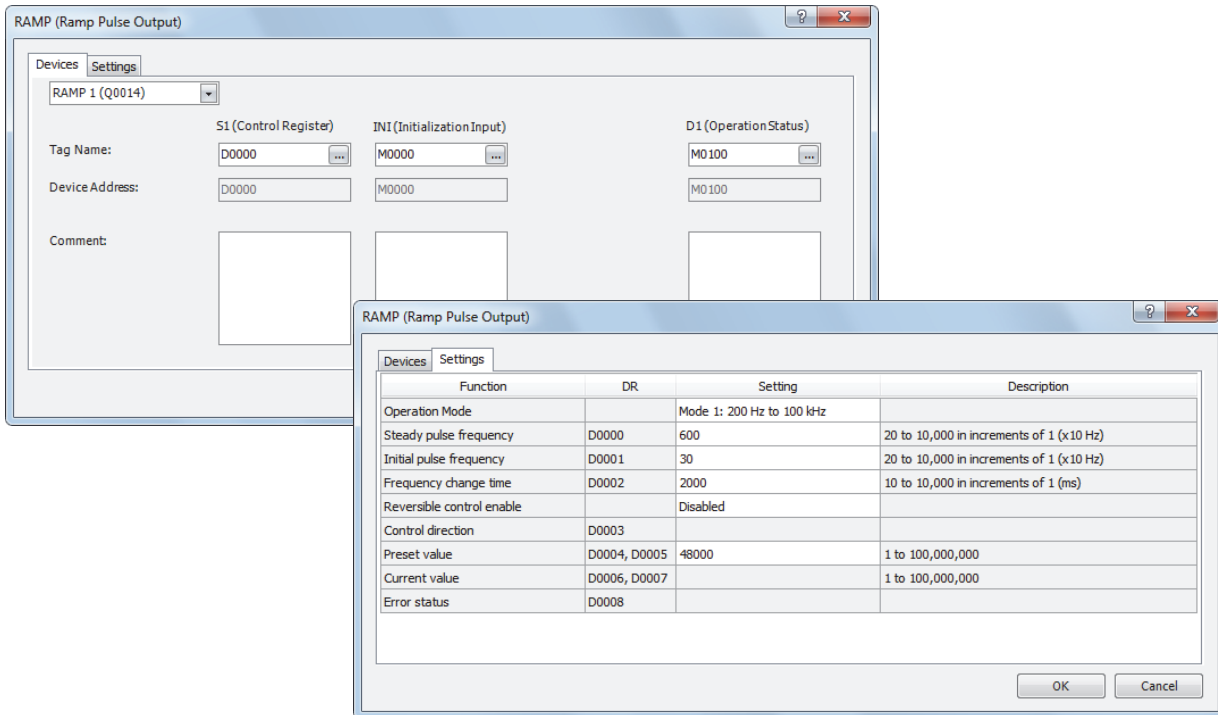

Function	Device address	Setting value	Details
Operation Mode	–	Mode 1	200 Hz to 100 kHz
Steady pulse frequency	D0000	600	6000 Hz
Initial pulse frequency	D0001	30	300 Hz
Frequency change time	D0002	2000	2,000 ms
Reversible control enable	–	Disable	–
Control direction	D0003	–	–
Preset value	D0004, D0005	48000	Preset value=48,000

[To output 100,000 pulses with the frequency change function (reversible control by single-pulse output) from Q14]

When the RAMP FB execution input (I0) turns from off to on, pulse output starts. When I1 is off, the control direction output (Q15) turns off (forward).

When I1 is on, the control direction output (Q15) turns on (reverse).

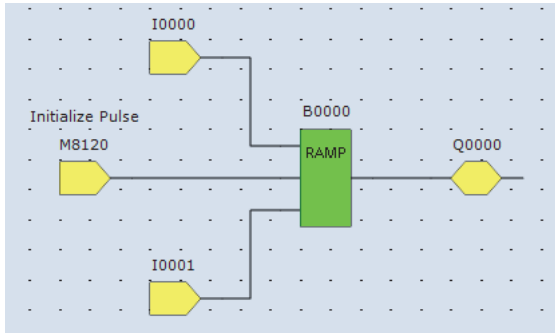

- When the SmartAXIS changes from STOP to RUN, the initialize input (M8120) turns on.
- When the RAMP FB execution input (I0) turns on, pulse output starts.
- When I1 is off, SmartAXIS operates in the forward direction.
- When I1 is on, SmartAXIS operates in the reverse direction.

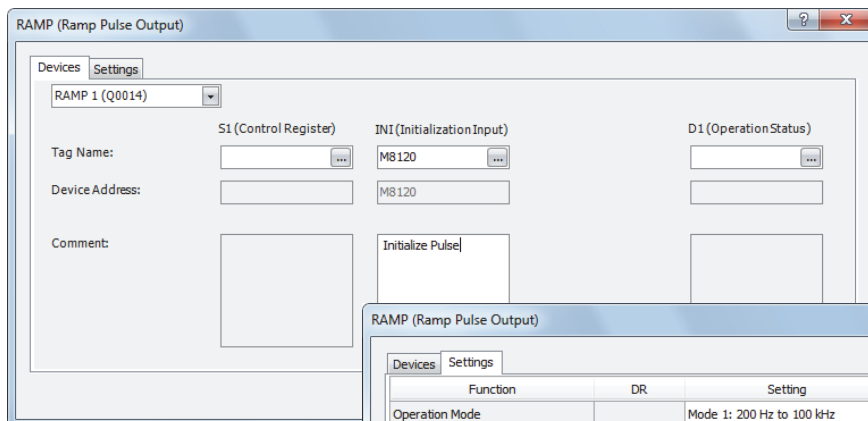

Function	DR	Setting	Description
Operation Mode		Mode 1: 200 Hz to 100 kHz	
Steady pulse frequency	D0000	1000	20 to 10,000 in increments of 1 (x10 Hz)
Initial pulse frequency	D0001	50	20 to 10,000 in increments of 1 (x10 Hz)
Frequency change time	D0002	2000	10 to 10,000 in increments of 1 (ms)
Reversible control enable		Single-pulse output	
Control direction	D0003		
Preset value	D0004, D0005	100000	1 to 100,000,000
Current value	D0006, D0007		1 to 100,000,000
Error status	D0008		

Function	Device address	Setting value	Details
Operation Mode	–	Mode 1	200 Hz to 100 kHz
Steady pulse frequency	D0000	1000	10 kHz
Initial pulse frequency	D0001	50	500 Hz
Frequency change time	D0002	2000	2,000 ms
Reversible control enable	–	Single-pulse output mode	–
Control direction	D0003	–	–
Preset value	D0004, D0005	100000	Preset value=100,000

15: THE PULSE FB

[To output 1,000,000 pulses with the frequency change function (reversible control by dual-pulse output)]

When the RAMP FB execution input (I0) turns from off to on, pulse output starts. For forward when I1 is off, pulses (CW) are output from Q14.

For reverse when I1 is on, pulses (CCW) are output from Q15.

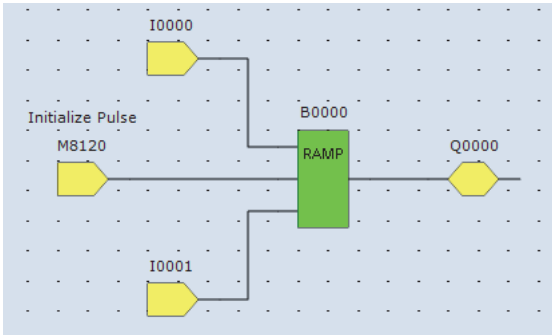

- When the SmartAXIS changes from STOP to RUN, the initialize input (M8120) turns on.
- When the RAMP FB execution input (I0) turns on, pulse output starts.
- When I1 is off, SmartAXIS operates in the forward direction.
- When I1 is on, SmartAXIS operates in the reverse direction.

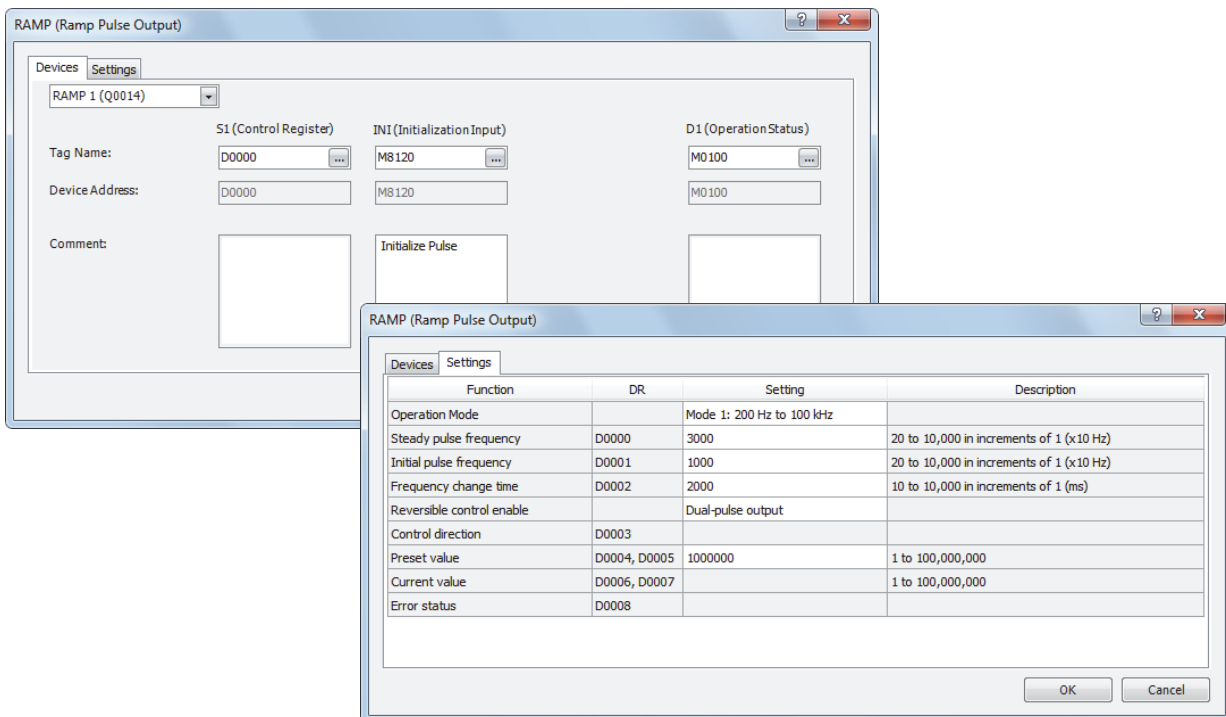

Function	Device address	Setting value	Details
Operation Mode	–	Mode 1	200 Hz to 100 kHz
Steady pulse frequency	D0000	3000	30 kHz
Initial pulse frequency	D0001	1000	10 kHz
Frequency change time	D0002	2000	2,000 ms
Reversible control enable	–	Dual-pulse output mode	–
Control direction	D0003	–	–
Preset value	D0004, D0005	1000000	Preset value=1,000,000

ZRN (Zero Return)

The ZRN FB outputs pulses with the different pulse frequency corresponding to the on/off state of a deceleration signal.

Symbol



Operation

When the execution input (EN) is on and the deceleration signal (DE) is off, pulses of the initial pulse frequency are output from the pulse output port until the proximity signal turns on.

When the deceleration signal turns on, pulses of the specified creep pulse frequency are output until the deceleration signal turns off. After that, when the deceleration signal turns off, pulse output stops.

When the execution input is off, pulse output stops.

When the initialization input (INI) is on, the initial values configured in the **Settings** tab of the editing dialog box in WindLDR are stored in the control registers.

Applicable SmartAXIS

FT1A-12	FT1A-24	FT1A-40	FT1A-48	FT1A Touch
–	–	X (Note)	X	–

Note: These instructions cannot be used with FT1A-H40RC and FT1A-B40RC.

Parameters

Parameter	Function	Range	Description	
Number	B	Block number	B0 to B999	Unique number to identify each function block. The block number is automatically assigned in ascending order from zero. The block number can be changed to a desired number. However, the block numbers already used in any other FBs cannot be used.
Input	EN	Execution input	On/off	When the execution input is on, pulses are output from the pulse output port according to the control register (S1) settings. When the execution input is off, the pulse output stops.
	INI	Initialization input*1	On/off	When the initialization input is on, the initial values configured in the Settings tab of the editing dialog box in WindLDR are stored in the control registers.
	DE	Deceleration signal input*2	On/off	The pulse frequency changes when the deceleration signal input turns on.
Output	OUT	Output	–	When the pulse output has completed, the output turns on and keeps on. It turns off when the execution input turns on.
Parameters	n	Pulse output port number	ZRN1, ZRN2	Specify the pulse output port number for the ZRN FB. The pulse output port differs with ZRN1 and ZRN2.
	S1	Control register	D0 to D997/ D1000 to D1997	Specify the starting number of the data registers to use with the ZRN FB. Starting from the specified data register, 3 consecutive data registers are used.
	D1	Operation status	M0 to M1270	Specify the starting number of the internal relays to use with the ZRN FB. Starting from the specified internal relay, 2 consecutive internal relays are used.

*1 The bit device such as an external input (I0 to I155) or an internal relay (M0 to M1277) can be specified. When the initialization input is on, the initial values are written to the data registers with each scan. To initialize the values only one time, use the initialization input in combination with the SOTU (Shot up) FB or the SOTD (Shot down) FB.

*2 An external input (I0 to I155) or an internal relay (M0 to M1277) can be specified.

Valid Devices

Parameter	Function	I	Q	M	R	T	TC	TP	C	CC	CP	B	D	AI	Constant
EN	Execution input	X	X	X	X	X	–	–	X	–	–	X	–	–	–
INI	Initialization input	X	–	X	–	–	–	–	–	–	–	X	–	–	–
DIR	Proximity signal input	X	–	X	–	–	–	–	–	–	–	–	–	–	–
S1	Control register	–	–	–	–	–	–	–	–	–	–	–	X*1	–	–
D1	Operation status	–	–	X*2	–	–	–	–	–	–	–	–	–	–	–

*1 Special data registers cannot be used.

*2 Internal relays can be used. However, the first digit of the internal relay number must be set to 0. Special internal relays cannot be used.

Settings

■ **Device tab**

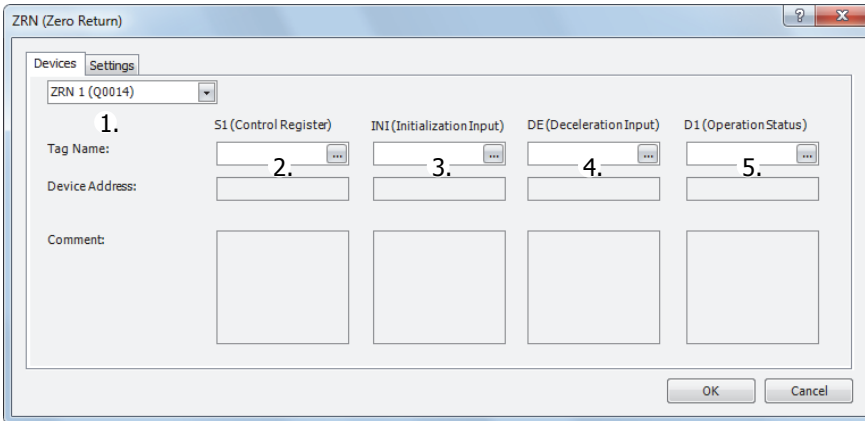

1. ZRN FB selection

Select the ZRN FB from ZRN1 or ZRN2.
The pulse output port differs by the ZRN FB.

ZRN FB	Pulse output port
ZRN1	Q14
ZRN2	Q15

2. S1: Control Register

S1 specifies the starting number of the data registers to use with the ZRN1 and ZRN2 FBs. Starting from the specified data register, 3 consecutive data registers are used. The range of available data registers is D0 to D997 and D1000 to D1997.

Storage destination	Function	Setting details	Reference
Starting number+0	Initial pulse frequency	Operation mode 0: 1 to 10,000 (1 Hz increments) Operation mode 1: 20 to 10,000 (10 Hz increments)	"7. Initial pulse frequency" on page 15-23
Starting number+1	Creep pulse frequency	Operation mode 0: 1 to 10,000 (1 Hz increments) Operation mode 1: 20 to 10,000 (10 Hz increments)	"9. Creep pulse frequency" on page 15-23
Starting number+2	Error status	0/2	"10. Error status" on page 15-23

3. INI: Initialization Input

INI specifies the initialization input. When the initialization input is on, the initial values configured in the **Settings** tab of the editing dialog box in WindLDR are stored in the control registers. The bit device such as an external input (I0 to I155) or an internal relay (M0 to M1277) can be specified.

When the initialization input is on, the initial values are written to the data registers with each scan. To initialize the values only one time, use the initialization input in combination with the SOTU (Shot up) FB or the SOTD (Shot down) FB.

4. DE: Deceleration Input

DE specifies the deceleration signal. Specify either an external input or an internal relay. The external input can be specified as (I0 to I155) or the internal relay can be specified as (M0 to M1277).

High-Speed	I0, I2, I3, I5, I6, I7	An interrupt is used to read the deceleration signal. The deceleration signal is read without being affected by the user program scan.
Normal	I1, I4, I10 to I155 M0 to M1277	The deceleration signal is read in the END processing. This is affected by the user program scan.

Notes:

- Do not use the same input or internal relay as the deceleration signal in the ZRN1 and ZRN2 FBs. If they operate simultaneously, pulse output may not stop even if the deceleration signal turns from on to off.
- To use the high-speed proximity signal, set the relevant input to **Normal Input** under **Special Input** on **Function Area Settings**. Do not use the input as catch input, high-speed counter, or frequency measurement.
- When using the high-speed deceleration signal, ensure that no chatter noise occurs in the deceleration signal.

5. D1: Operation Status

D1 specifies the starting number of the internal relays to use with the ZRN1 and ZRN2 FBs. These ZRN FBs use 2 consecutive internal relays starting from the specified internal relay. The range of available internal relay number is M0 to M1270. Caution: The first digit of the internal relay number must be 0 (not 1 to 7). Otherwise, the ZRN FB will not operate correctly.

Storage destination	Function	Setting details	
Starting number+0	Pulse output ON	0: Pulse output OFF 1: Pulse output ON	This relay remains on during pulse output. This relay turns off when pulse output stops or when the deceleration signal turns off and pulse output completes.
Starting number+1	Pulse output complete*1	0: Pulse output not complete 1: Pulse output complete	This relay turns on when the deceleration signal turns off and pulse output has completed. This relay turns off when pulse output starts.

*1 The pulse output complete on/off state is reflected in the PULS FB output (OUT). However, when the execution input is off, the ZRN FB output (OUT) is off.

■ Parameter tab

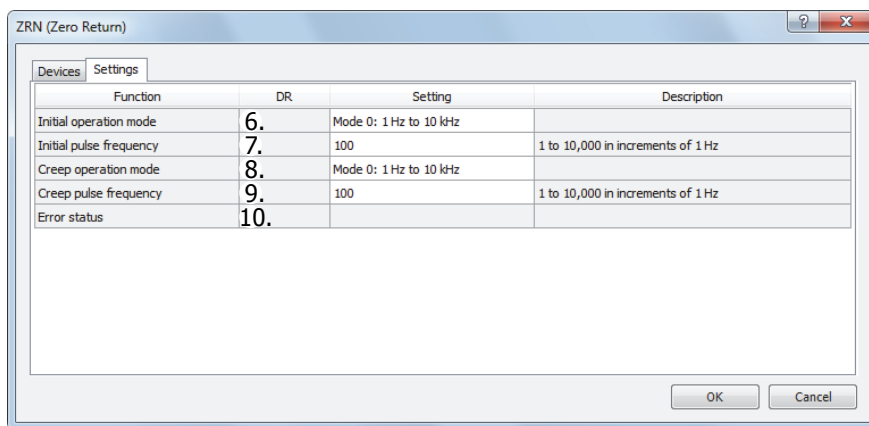

6. Initial operation mode

Select the range of frequencies to output from the two modes.

Initial operation mode	
0:	1 Hz to 10 kHz (1 Hz increments)
1:	200 Hz to 100 kHz (10 Hz increments)

7. Initial pulse frequency

Specify the initial pulse frequency to output.

Initial operation mode 0: Set the frequency in the range of 1 Hz to 10 kHz in 1 Hz increments.

Initial operation mode 1: Set the frequency in the range of 200 Hz to 100 kHz in 10 Hz increments.

8. Creep operation mode

Select the range of frequencies to output from the two modes.

Creep operation mode	
0:	1 Hz to 10 kHz (1 Hz increments)
1:	200 Hz to 100 kHz (10 Hz increments)

9. Creep pulse frequency

Specify the creep pulse frequency to output.

Creep operation mode 0: Set the frequency in the range of 1 Hz to 10 kHz in 1 Hz increments.

Creep operation mode 1: Set the frequency in the range of 200 Hz to 100 kHz in 10 Hz increments.

10. Error status

If a configuration error occurs when the ZRN FB execution input turns from off to on, M8004 (user program execution error) is turned on and the error code is stored in this register.

Error code	Content	Details
0	Normal	—
2	Initial pulse frequency designation error	The frequency was not set to a value between 1 and 10,000 in operation mode 0. The frequency was not set to a value between 20 and 10,000 in operation mode 1.

Operation example

ZRN1 FB timing chart

For ZRN1 FB, the external input I0 is connected to EN, the internal relay M0 is connected to INI, the external input I2 is connected to DE, D200 is specified to S1, the internal relay M10 is specified to D1.

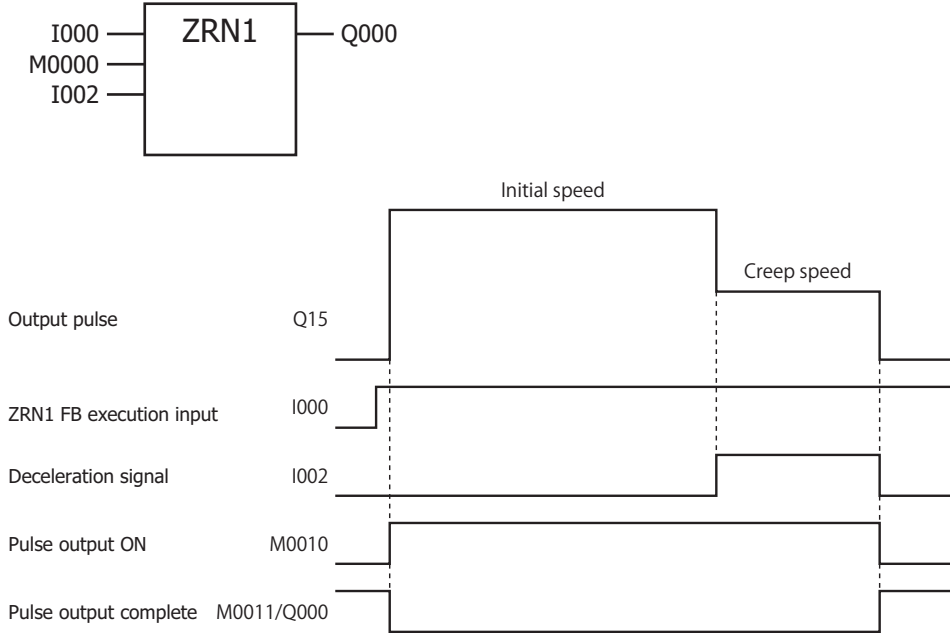

- When the ZRN1 FB execution input turns from off to on, pulse output starts at the initial pulse frequency.
- When pulse output starts, M10 turns on, M11 turns off, and Q0 turns off.
- When the deceleration signal (I2) turns from off to on, pulse output frequency changes to the creep pulse frequency.
- When the deceleration signal (I2) turns from on to off, pulse output stops.
- When pulse output stops, M10 turns off, M11 turns on, and Q0 turns on.
- If the ZRN1 FB execution input (I0) turns off during pulse output, pulse output stops immediately. If the execution input (I0) turns on again, operation starts from the beginning.
- Even if the contents of the data registers are changed during pulse output, the change is not reflected in pulse output operation. The changed content is reflected the next time the ZRN1 FB execution input turns from off to on.
- The state of the initialization input (M0) are not reflected while the ZRN1 FB execution input is on. If you wish to initialize the data registers with the initialization input, turn the initialization input on after turning off the execution input.

Sample program

[To perform a zero return operation with deceleration signal I3, initial pulse frequency 3 kHz, and creep pulse frequency 800 Hz]

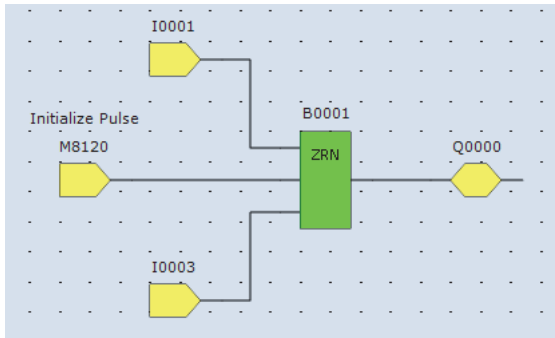

- When the SmartAXIS changes from STOP to RUN, the initialize input (M8120) turns on.
- When the ZRN1 FB execution input turns on, pulse output starts.

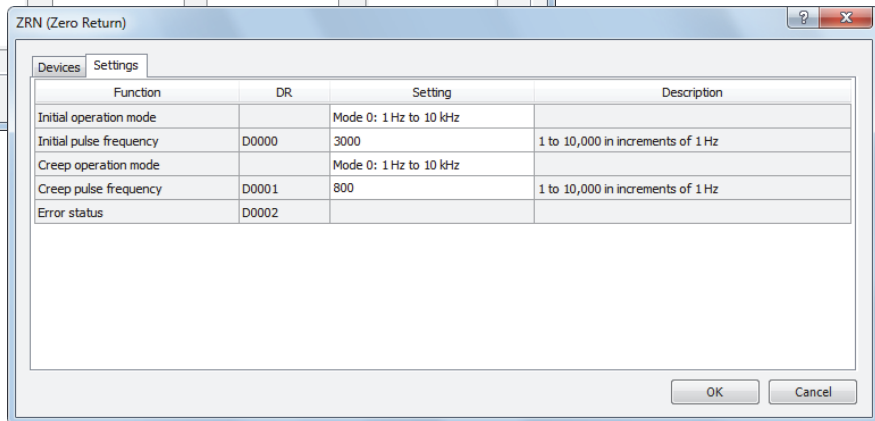
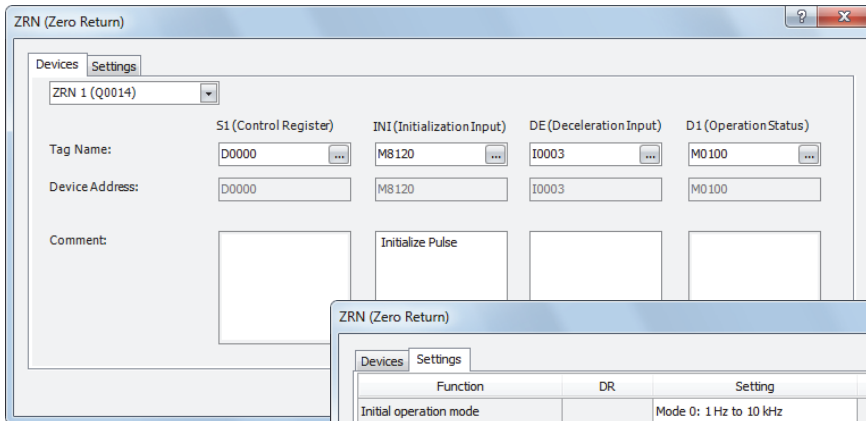

Function	Device address	Setting value	Details
Initial operation mode	–	Mode 0	1 Hz to 10 kHz
Initial pulse frequency	D0000	3000	3 kHz
Creep operation mode	–	Mode 0	1 Hz to 10 kHz
Creep pulse frequency	D0001	800	800 Hz

ARAMP (Advanced Ramp)

The ARAMP FB outputs pulses with the frequency change function according to the information in the frequency table.

Symbol



Operation

When the execution input (EN) is on, pulses are output according to the frequency change settings stored in the specified control registers. The pulse frequency is controlled by combining multiple steps that define the frequency change time and steady pulse speed.

The pulse frequency changes at a constant rate until it reaches the steady pulse frequency, and then it keeps until the current pulse count reaches the preset value. Or, the pulse frequency keeps the frequency of the previous step, and then it changes at a constant rate until it reaches the steady pulse frequency. You can select one or the other in the step option settings. The next step is executed when the number of pulses output reaches the preset value. You can configure a maximum of 18 steps.

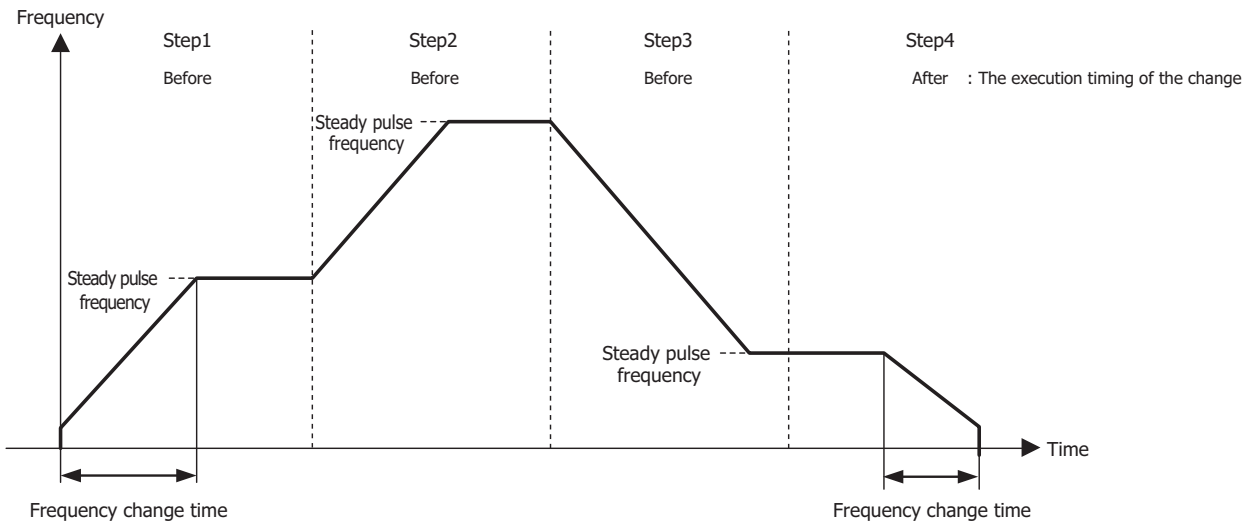

When the initialization input (INI) is turned on, the initial values configured in the **Settings** tab of the editing dialog box in WindLDR the control registers.

When the interrupt input (INT) is turned on, the step being executed is aborted and the interrupt step is executed.

The current pulse count of the current step and the settings, including the preset value and the steady pulse frequency, are stored in the specified data registers.

The control status, including the pulse output status (output on, control direction, output complete), is stored as the operation status in the specified internal relays.

Note: The same pulse output port cannot be shared with more than one ARAMP FB.

However, the ZRN (Zero Return) FB can be configured with the same pulse output port as the PULS (Pulse Output), PWM (Pulse Width Modulation), RAMP (Ramp Pulse Output), and ARAMP (Advanced Ramp) FBs.

Applicable SmartAXIS

FT1A-12	FT1A-24	FT1A-40	FT1A-48	FT1A Touch
-	-	X (Note)	X	-

Note: These instructions cannot be used with FT1A-H40RC and FT1A-B40RC.

Parameters

Parameter		Function	Range	Description
Number	B	Block number	B0 to B999	Unique number to identify each function block. The block number is automatically assigned in ascending order from zero. The block number can be changed to a desired number. However, the block numbers already used in any other FBs cannot be used.
	EN	Execution input	On/off	When the execution input is on, pulses are output from the pulse output port according to the control register (S1) settings. When the execution input is off, the pulse output stops.
Input	INI	Initialization input*1	On/off	When the initialization input is on, the initial values configured in the Settings tab of the editing dialog box in WindLDR are stored in the control registers.
	INT	Interrupt input*2	On/off	When the interrupt input turns on, the pulse output process for the running step is aborted, and pulse output restarts with the settings for the step specified by the interrupt number.
Output	OUT	Output	–	When the pulse output has completed, the output turns on and keeps on.
Parameters	n	Pulse output port number	ARAMP1/ ARAMP2	Specify the pulse output port number for the ARAMP FB. The pulse output port differs with ARAMP1 and ARAMP2.
	S1	Control register	D0 to D992 (Dependent on the number of steps)*3	The control data registers Starting from the specified data register, (2+6xN (N: number of steps)) consecutive data registers are used.
	D1	Monitor register	D0 to D991/ D1000 to D1991	The monitor data registers Starting from the specified data register, 9 consecutive data registers are used.
	D2	Operation status	M0 to M1270*4	The operation status Starting from the specified internal relay, 5 consecutive internal relays are used.

*1 The bit device such as an external input (I0 to I155) or an internal relay (M0 to M1277) can be specified. When the initialization input is on, the initial values are written to the data registers with each scan. To initialize the values only one time, use the initialization input in combination with the SOTU (Shot up) FB or the SOTD (Shot down) FB.

*2 An external input (I0 to I155) or an internal relay (M0 to M1277) can be specified.

*3 Specify the start address of data register according to the number of steps to ensure that the last address doesn't over D0999.

*4 The first digit of the internal relay number must be set to 0.

Valid Devices

Parameter	Function	I	Q	M	R	T	TC	TP	C	CC	CP	B	D	AI	Constant
EN	Execution input	X	X	X	X	X	–	–	X	–	–	X	–	–	–
INI	Initialization input	X	–	X	–	–	–	–	–	–	–	X	–	–	–
DIR	Interrupt input	X	–	X	–	–	–	–	–	–	–	–	–	–	–
S1	Control register	–	–	–	–	–	–	–	–	–	–	–	X*1	–	–
D1	Monitor register	–	–	–	–	–	–	–	–	–	–	–	X*1	–	–
D2	Operation status	–	–	X*2	–	–	–	–	–	–	–	–	–	–	–

*1 Special data registers cannot be used.

*2 Special internal relays cannot be used. The first digit of the internal relay number must be set to 0.

Settings

■ Device tab

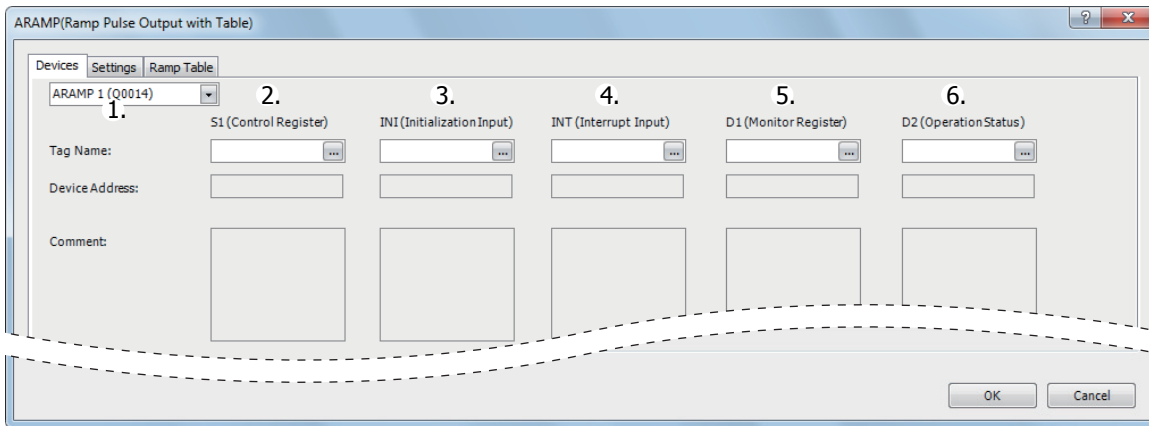

1. ARAMP FB selection

Selects the ARAMP FB to use from ARAMP1 or ARAMP2.

The reversible control mode that can be selected differs according to the pulse output port number.

For the combinations of pulse output port numbers and the reversible control mode, see "8. Reversible control enable" on page 15-31.

2. S1: Control Register

S1 specifies the starting number of the data registers to use with the ARAMP1 and ARAMP2 FBs.

Starting from the specified data register, "2+6xN (N: number of steps)" consecutive data registers are used.

The range of available data register is D0 to D992 (dependent on the number of steps).

Each step operates with the settings that are configured when the steps start. If the settings for the step being executed are changed after it starts running, those changes are not reflected while the step is running.

Storage destination	Function	Setting details	Reference
Starting number+0	Interrupt number	1 to 18	"11. Interrupt step number" on page 15-32
Starting number+1	Reserved		
Step 1 (6 words)			
Starting number+2	Steady pulse frequency	Mode 0: 1 to 10,000 (1 Hz increments) Mode 1: 20 to 10,000 (10 Hz increments)	"13. Steady pulse frequency" on page 15-32
Starting number+3	Frequency change time	10 to 10,000 ms	"14. Frequency change time" on page 15-32
Starting number+4	Preset value (upper word) ^{*1}	1 to 100,000,000 pulses	"15. Preset value" on page 15-32
Starting number+5	Preset value (lower word) ^{*1}		
Starting number+6	Step options	0 to 3	"16. Step options" on page 15-32
Starting number+7	Next step number	1 to 18	"17. Next step number" on page 15-32
Step 2 (6 words)			
Starting number+8	Steady pulse frequency	Mode 0: 1 to 10,000 (1 Hz increments) Mode 1: 20 to 10,000 (10 Hz increments)	"13. Steady pulse frequency" on page 15-32
:	:	:	:
Starting number+13	Next step number	1 to 18	"17. Next step number" on page 15-32
:	:	:	:
Step N (6 words)			
Starting number+2+ Nx6-6	Steady pulse frequency	Mode 0: 1 to 10,000 (1 Hz increments) Mode 1: 20 to 10,000 (10 Hz increments)	"13. Steady pulse frequency" on page 15-32
:	:	:	:
Starting number+7+ Nx6-6	Next step number	1 to 18	"17. Next step number" on page 15-32

*1 The upper and lower data registers switch according to the setting of the 32-bit data storage method. For details, see Chapter 5 "Special Functions" - "32-bit Data Storage Setting" in the SmartAXIS Pro/Lite User's Manual.

3. INI: Initialization Input

INI specifies the initialization input. When the initialization input is on, the initial values configured in the **Settings** tab of the editing dialog box in WindLDR are stored in the control registers. The bit device such as an external input (I0 to I155) or an internal relay (M0 to M1277) can be specified.

When the initialization input is on, the initial values are written to the data registers with each scan. To initialize the values only one time, use the initialization input in combination with the SOTU (Shot up) FB or the SOTD (Shot down) FB.

4. INT: Interrupt Input

When the interrupt input turns from off to on, the pulse output process for the running step is aborted, and pulse output restarts with the settings for the step specified by the interrupt number.

In the following example, the interrupt input turns on while step 2 is running. Pulse output processing for step 2 aborts and the operation transitions to step 12.

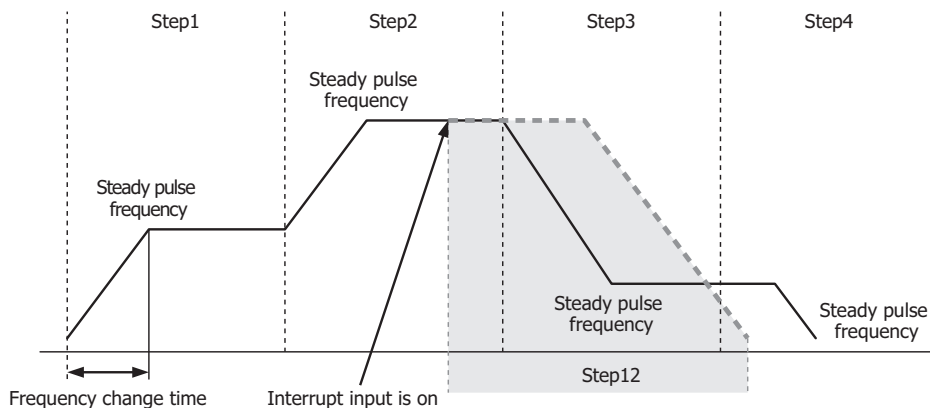

An external input (I0 to I35) or internal relay (M0 to M1277) can be specified as the interrupt input.

High-Speed	I0, I2, I3, I5, I6, I7	An interrupt is used to read the interrupt input. The interrupt input can be read without being affected by the user program scan.
Normal	I1, I4, I10 to I35 M0 to M1277	The interrupt input is read in the END processing. This is affected by the user program scan.

Notes:

- Do not use the same input or internal relay as the interrupt input signal for the ARAMP1 and ARAMP2 FBs.
- To use high-speed interrupt input, set the relevant input to **Normal Input** under **Special Input** on **Function Area Settings**. Do not use the input as catch input, high-speed counter, or frequency measurement.
- When using the high-speed interrupt input, ensure that no chatter noise occurs in the interrupt input.

5. D1: Monitor Register

D1 specifies the starting number of the data registers to use with ARAMP1 or ARAMP2. Starting from the specified data register, 9 consecutive data registers are used. The range of available data registers is D0 to D991 and D1000 to D1991. The monitor registers is read-only.

Address	Content		Value range (unit)
Starting number+0	Next step number		0 to 18
Starting number+1	Running step number		1 to 18
Starting number+2	Steady pulse frequency monitor		Mode 0: 1 to 10,000 (1 Hz increments), mode 1: 20 to 10,000 (10 Hz increments)
Starting number+3	Frequency change time monitor		10 to 10,000 ms
Starting number+4	Preset value monitor	(Upper word) ^{*1}	1 to 100,000,000 pulses
Starting number+5		(Lower word) ^{*1}	
Starting number+6	Current value	(Upper word) ^{*1}	1 to 100,000,000 pulses
Starting number+7		(Lower word) ^{*1}	
Starting number+8	Error status		0 to 9

*1 The upper and lower data registers switch according to the setting of the 32-bit data storage method.
For details, see Chapter 5 "Special Functions" - "32-bit Data Storage Setting" in the SmartAXIS Pro/Lite User's Manual.

Next step number

This register stores the number of the step to execute next.

If the next step number is 0, pulse output ends after the current step is complete.

15: THE PULSE FB

Running step number

This register stores the current step number.

Steady pulse frequency monitor

This register stores the steady pulse frequency for the current step.

Frequency change time monitor

This register stores the frequency change time for the current step.

Set the time in the range of 10 to 10,000 ms in 10 ms increments. The first digit of the setting is discarded.

Preset value monitor

This register stores the preset value for the current step.

Current value

This register stores the number of pulses that have been output for the current step. The current value is updated when the ARAMP FB is executed at each scan.

Error status

If a configuration error occurs when each step starts running, M8004 (user program execution error) is turned on and the error code is stored in this register.

Error code	Status	Content
0	Normal	–
3	Preset value designation error	The preset value was not set between 1 to 100,000,000.
4	Steady pulse frequency designation error	The frequency was not set between 1 to 10,000 in operation mode 0. The frequency was not set between 20 to 10,000 in operation mode 1.
5	Frequency change time designation error	The frequency change time was not set between 10 and 10,000.
7	Step options designation error	The step options were not set to a valid value.
8	Next step number designation error	The next step number was not set between 0 and 18.
9	Interrupt number designation error	The interrupt number was not set between 1 and 18.

6. D2: Operation Status

D2 specifies the starting number of the internal relays to use with the ARAMP1 and ARAMP2 FBs.

Starting from the specified internal relay, 5 consecutive internal relays are used.

The range of available internal relay numbers is M0 to M1270. The first digit of the internal relay number must be set to 0.

Address	Content		
Starting number+0	Pulse output ON	0: Pulse output OFF 1: Pulse output ON	This relay remains on during pulse output. This relay turns off when pulse output stops. This relay turns off when the specified number of pulses are output and output completes.
Starting number+1	Pulse output complete*1	0: Pulse output not complete 1: Pulse output complete	This relay turns on when pulse output completes. This relay turns on when the current step number changes to 0. This relay is off during pulse output.
Starting number+2	Pulse output state	0: Steady pulse output 1: Changing output pulse frequency	This relay is off when the pulse output state is steady. This relay is on when the pulse output is changing.
Starting number+3	Overflow	0: Overflow not occurred 1: Overflow occurred	This relay turns on when the pulses output more than the configured preset value. Pulse output continues even if the overflow occurs during steady pulse output or while the pulse frequency is changing. However, pulse counting (current value data register) is suspended at the point when the overflow occurred.
Starting number+4	Control direction*2	0: Forward 1: Reverse	This relay is off when the control direction of the pulses being output is forward. This relay is on when the control direction of the pulses being output is reverse.

*1 The pulse output complete on/off state is reflected in the ARAMP FB output (OUT). However, when the execution input is off, the ARAMP FB output (OUT) is off.

*2 If reversible control is enabled, the control direction input on/off state is reflected.

Parameter tab

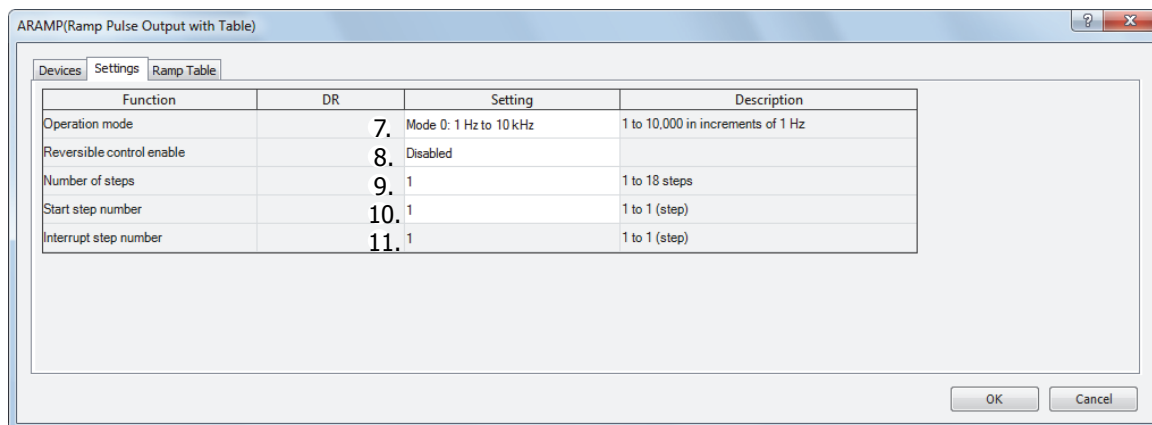

7. Operation mode

Select the output frequency range from following operation modes.

Operation mode	
0:	1 Hz to 10 kHz (1 Hz increments)*1
1:	200 Hz to 100 kHz (10 Hz increments)*1







*1 The output frequency error is within ±5%.

8. Reversible control enable

This setting enables or disables reversible control and selects the reversible control method from the following reversible control modes.

Reversible control enable	
Mode 0:	Disable
Mode 1:	Single-pulse output
Mode 2:	Dual-pulse output

The details of reversible control mode are as follows.

Disabled	Select this option when using pulse output in a single direction. Pulse A and pulse B can be used independently.	A  B 
Reversible control Single-pulse output mode	Pulse A or B is used as pulse output. On/off state of pulse C is used as reversible control.	A/B  C 
Reversible control Dual-pulse output mode	Pulse A is used as forward pulse (CW) output. Pulse B is used as reverse pulse (CCW) output.	A  B 

The ports used on the SmartAXIS differ according to the combination of the RAMP FB pulse output port number, the reversible control enable setting, and the I/O type of SmartAXIS.

RAMP FB	Reversible control enable	Port used			
		40-I/O type		48-I/O type	
		Pulse output port	Control direction	Pulse output port	Control direction
ARAMP1	Disable	Q14(A)	—	Q14(A)	—
	Single-pulse output	Q14(A)	Q16(C)*1 *2	Q14(A)	Q12(C)*2
	Dual-pulse output	Q14(A)	Q15(B)*3	Q14(A)	Q15(B)*3
ARAMP2	Disable	Q15(B)	—	Q15(B)	—
	Single-pulse output	Q15(B)	Q17(C)*1 *2	Q15(B)	Q13(C)*2
	Dual-pulse mode cannot be used.	—	—	—	—

*1 When using single-pulse output mode on the 40-I/O type, Q16 or Q17 is used as the control direction port. Therefore, PULS3, PWM3, or PULS4, PWM4 cannot be used.

*2 Outputs the on/off state of the control direction input.

*3 When using ARAMP1 in dual-pulse output mode, RAMP2 or ARAMP2 cannot be used.

9. Number of step

Specify the number of steps. The maximum is 18 steps.

10. Start step number

When the input turns from off to on, pulse output starts with the settings for the step configured as the start number.

11. Interrupt step number

When the interrupt input changes from off to on, the pulse output process for the running step is aborted, and pulse output restarts with the settings for the step configured by the interrupt number.

■ RAMP table (frequency table) tab

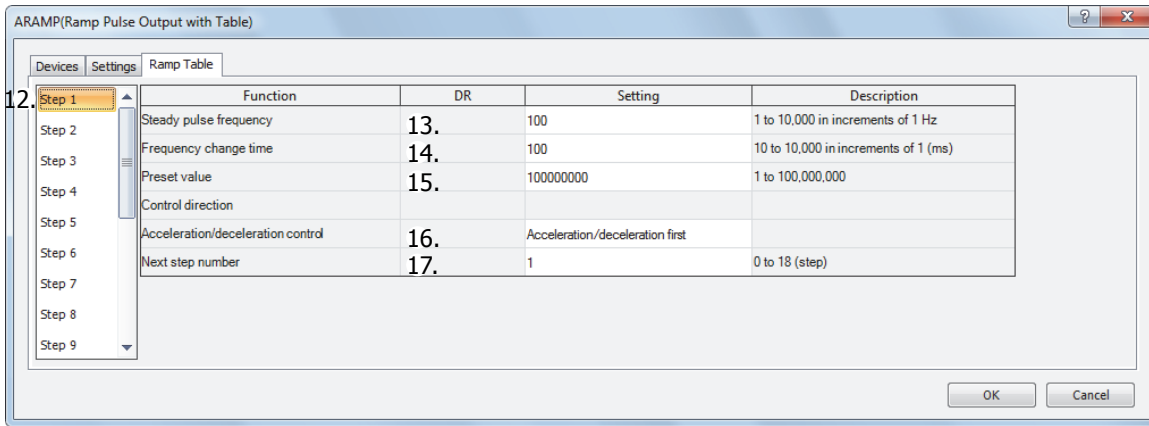

12. Step numbers

Selects the step number to configure.

13. Steady pulse frequency

This setting specifies the frequency at the steady output state before or after changing the frequency. For mode 0, set this value in the range of 1 to 10,000 (1 Hz increments). For mode 1, set this value in the range of 20 to 10,000 (10 Hz increments).

14. Frequency change time

This setting specifies the time to increase and to decrease the pulse frequency. Set this value in the range of 10 to 10,000 (10 ms increments). The first digit of the setting is ignored.

15. Preset value

This setting configures the number of output pulses in the range of 1 to 100,000,000.

16. Step options

This setting configures the control direction for the step and the execution timing of the change in the step.

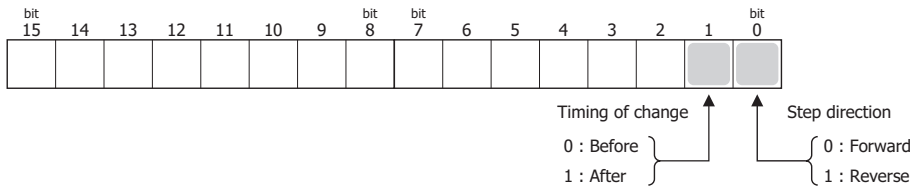

The frequency changes as shown in the following diagram according to the setting for the execution timing of the change. For Before, the pulse frequency changes at a constant rate until it reaches the steady pulse frequency, and then it keeps until the current pulse count reaches the preset value. Then, the operation transitions to the next step. For After, the pulse frequency keeps the frequency of the previous step, and then it changes at a constant rate until it reaches the steady pulse frequency. You can select one or the other in the step option settings. Then, the operation transitions to the next step.

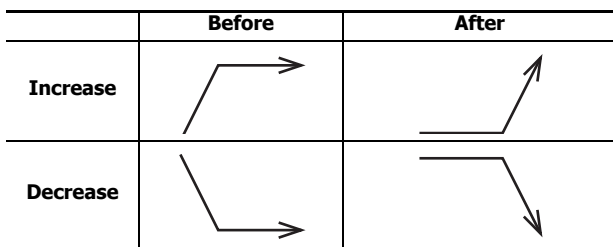

17. Next step number

This setting specifies the number of the next step to be executed after the currently executed step is completed.

Operation example

ARAMP1 FB (reversible control disabled) timing chart

[ARAMP1 FB, EN is specified as external input I0, INI is specified as internal relay M0000, INT is not connected, S1 is specified as data register D0200, D1 is specified as data register D0000, and D2 is specified as internal relay M0050]

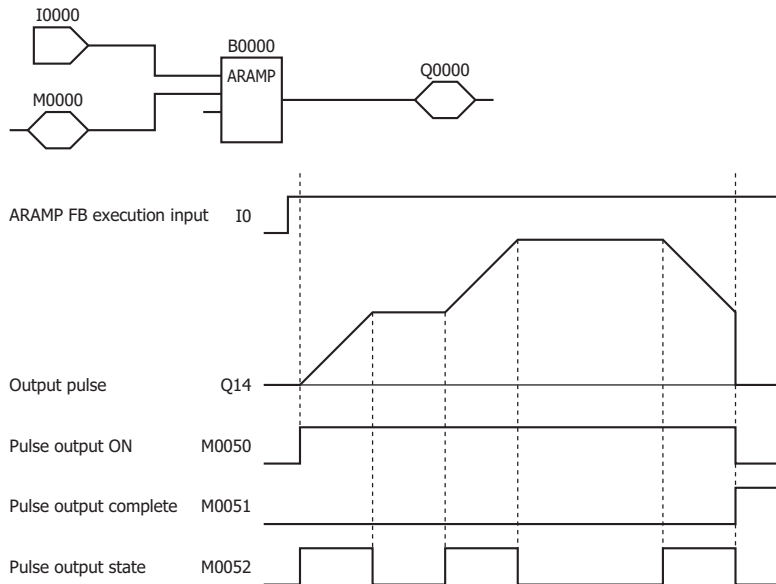

- When the ARAMP1 FB execution input (I0) changes from off to on, pulses are output from Q14 according to the settings configured by the data registers.
- M50 turns on during pulse output. M52 turns on or off while increasing or decreasing the pulse frequency.
- Pulses are output according to the frequency change time, until they reach the steady pulse frequency (from the initial pulse frequency).
- Pulse output stops when the pulses configured by the preset value are output. At this time, M50 turns off and M51 turns on.
- If the ARAMP1 FB execution input turns off during pulse output, pulse output is stopped. If the ARAMP1 FB execution input turns on again, the pulse count is reset and pulse counting starts.
- Even if the contents of the control registers are changed during pulse output, the change is not reflected in the pulse output operation. The changed content is reflected the next time the ARAMP1 FB is started.
- The changes from the initialization input (M00) are not reflected while the ARAMP1 FB execution input is on. If you wish to initialize the data registers with the initialization input, turn the initialization input (M00) on after turning off the ARAMP1 FB execution input.

ARAMP1 FB (reversible control enabled, single-pulse output mode) timing chart

[ARAMP1 FB, EN is specified as external input I0, INI is specified as internal relay M0000, INT is not connected, S1 is specified as data register D0200, D1 is specified as data register D0000, and D2 is specified as internal relay M0050]

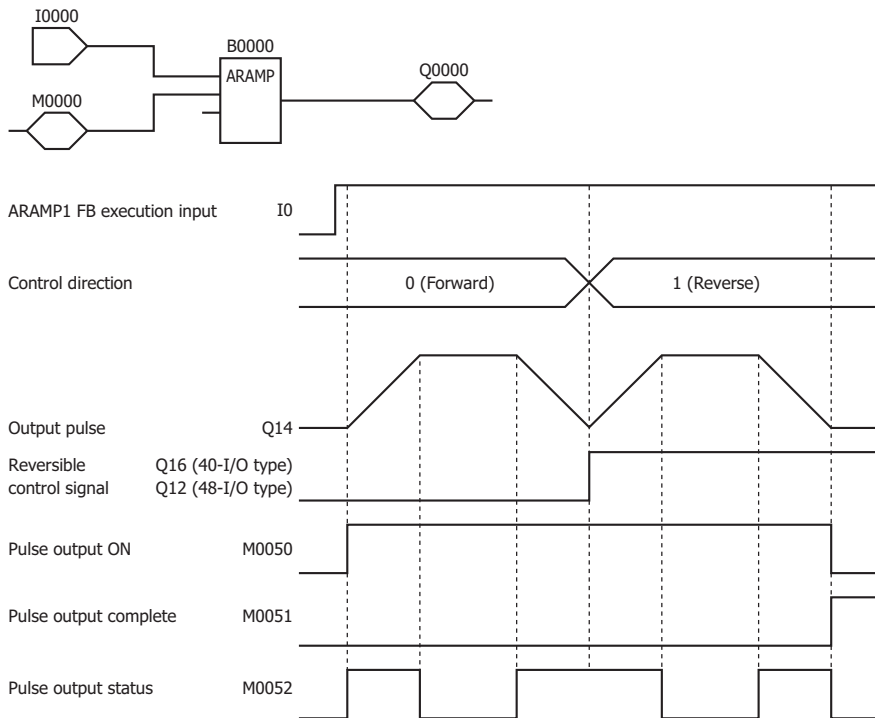

- When the ARAMP1 FB execution input changes from off to on, pulses are output from Q14 according to the settings configured by the data registers. The reversible control signal is output from Q16 or Q12.
- When pulse output starts, M50 turns on. M52 turns on while the pulse frequency is increasing or decreasing.
- The pulses increase according to the frequency change time until they reach the steady pulse frequency (from the initial pulse frequency).
- When the configured number of pulses are output, the pulses stop. In this situation, M50 turns off and M51 turns on.
- If the ARAMP1 FB execution input turns off during pulse output, pulse output is stopped. If this input turns on again, the operation starts from the beginning.
- Even if the contents of the data registers are changed during pulse output, the change is not reflected in the pulse output operation. The changed content is reflected the next time the ARAMP1 FB is started.
- You cannot change between forward and reverse until the pulse output pulse frequency is set to its minimum. In mode 1 for example, you cannot change between forward and reverse until the pulse frequency is set to 200 Hz.
- The changes from the initialization input (M00) are not reflected while the ARAMP1 FB execution input is on. If you wish to initialize the data registers with the initialization input, turn the initialization input (M00) on after turning off the input.

ARAMP1 FB (reversible control enabled, dual-pulse output mode) timing chart

[ARAMP1 FB, EN is specified as external input IO, INI is specified as internal relay M0000, INT is not connected, S1 is specified as data register D0200, D1 is specified as data register D0000, and D2 is specified as internal relay M0050 on the 40-I/O type]

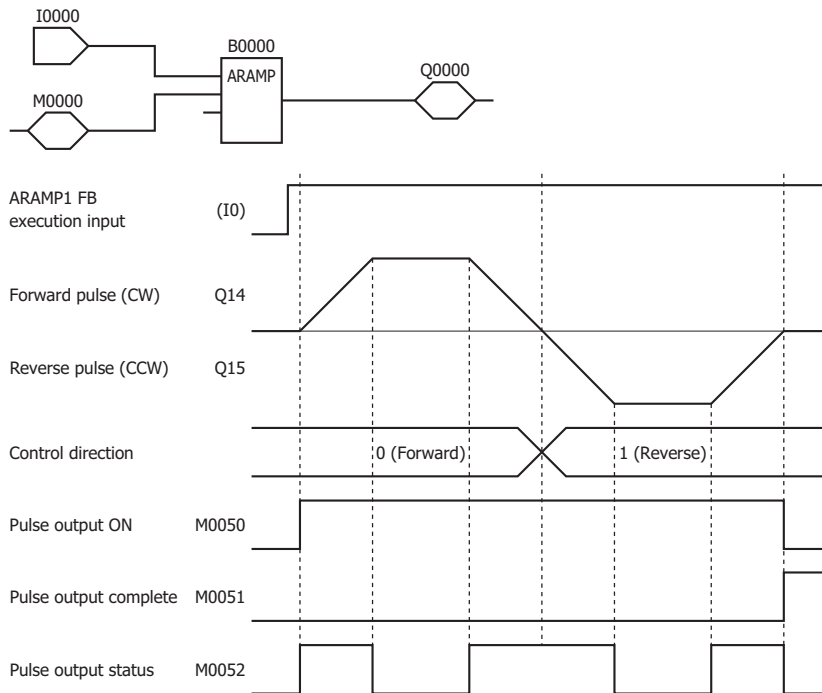

- When the ARAMP1 FB execution input (IO) changes from off to on, pulses are output from Q14 according to the settings configured by the data registers. The reversible control signal is output from Q14 or Q15.
- When pulse output starts, M50 turns on. M52 turns on while the pulse frequency is increasing or decreasing.
- The pulses increase according to the frequency change time until they reach the steady pulse frequency (from the initial pulse frequency).
- When the configured number of pulses are output, the pulses stop. In this situation, M50 turns off and M51 turns on.
- If the ARAMP1 FB execution input turns off during pulse output, pulse output is stopped. If this input turns on again, the operation starts from the beginning.
- Even if the contents of the data registers are changed during pulse output, the change is not reflected in the pulse output operation. The changed content is reflected the next time the ARAMP1 FB is started.
- You cannot change between forward and reverse until the pulse output pulse frequency is set to its minimum.
- The changes from the initialization input (M00) are not reflected while the ARAMP1 FB execution input is on. If you wish to initialize the data registers with the initialization input, turn the initialization input (M00) on after turning off the input.

15: THE PULSE FB

Sample program

This section describes an example program that outputs pulses as shown below with the frequency change function (reversible control disabled) using the following settings. The pulses are output from Q14.

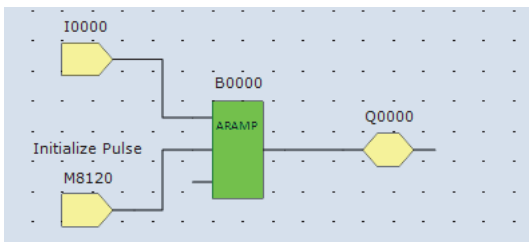
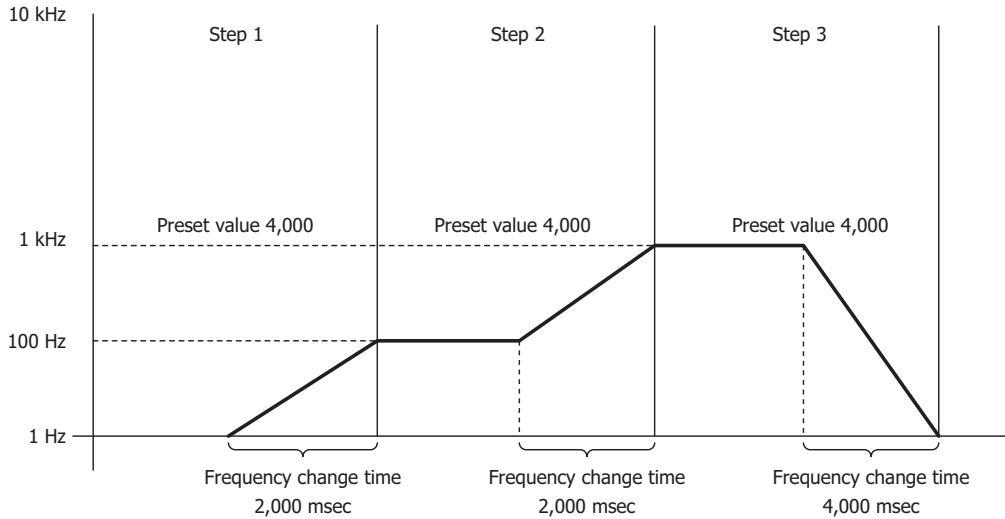

- Initialize the data registers when SmartAXIS starts.
- When the ARAMP1 FB execution input (I0) turns on, pulse output starts.

Basic settings

The screenshot shows the ARAMP(Ramp Pulse Output with Table) parameter setting dialog box. The Settings tab is active, displaying various registers and a Ramp Table. The Ramp Table is as follows:

Function	DR	Setting	Description
Operation mode		Mode 0: 1 Hz to 10 kHz	1 to 10,000 in increments of 1 Hz
Reversible control enable		Disabled	
Number of steps		3	1 to 18 steps
Start step number		1	1 to 3 (step)
Interrupt step number	D0000	1	1 to 3 (step)

Function	Device address	Setting value	Details
Operation mode	–	Mode 0	1 Hz to 10 kHz
Reversible control enable	–	Disabled	–
Number of steps	–	3	–
Start step number	–	1	Step 1
Interrupt step number	D0000	–	–

Step 1 settings

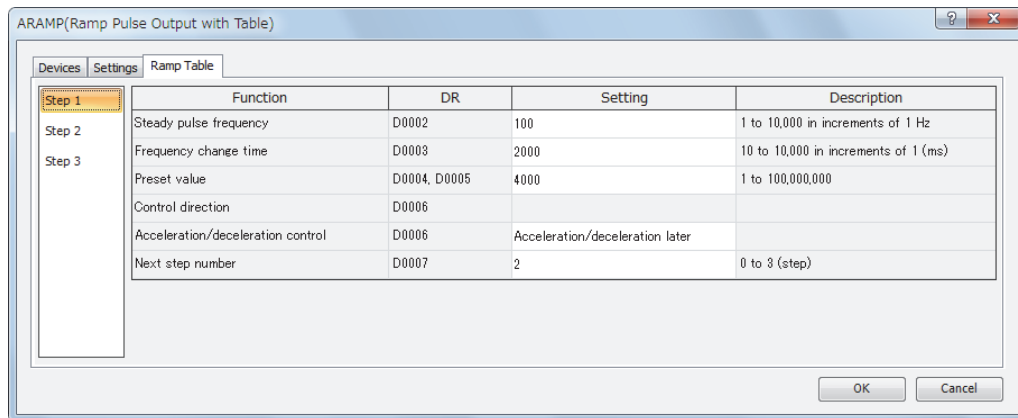

Function	Device address	Setting value	Details
Steady pulse frequency	D0002	100	100 Hz
Frequency change time	D0003	2000	2,000 msec
Preset value	D0004, D0005	4000	Preset value=4,000
Control direction	D0006	–	–
Acceleration/deceleration control	D0006	Acceleration/deceleration later	Acceleration/deceleration later=2
Next step number	D0007	2	Step 2

Step 2 settings

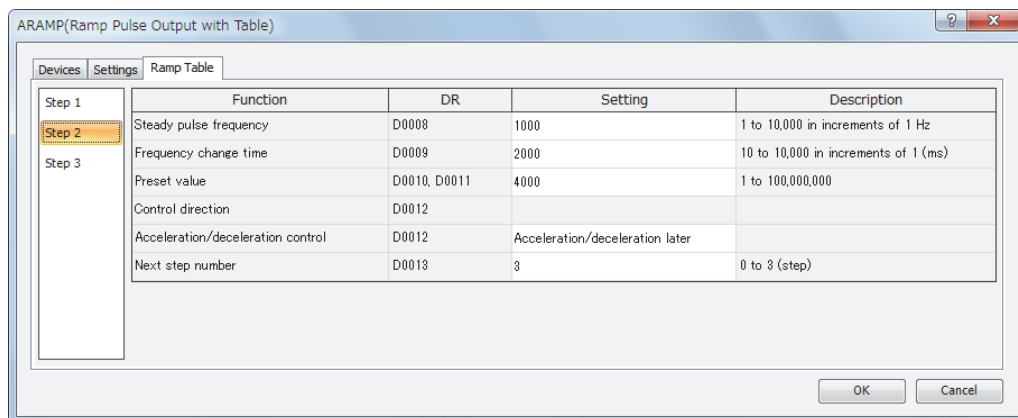

Function	Device address	Setting value	Details
Steady pulse frequency	D0008	1000	1,000 Hz
Frequency change time	D0009	2000	2,000 msec
Preset value	D0010, D0011	4000	Preset value=4,000
Control direction	D0012	–	–
Acceleration/deceleration control	D0012	Acceleration/deceleration later	Acceleration/deceleration later=2
Next step number	D0013	3	Step 3

Step 3 settings

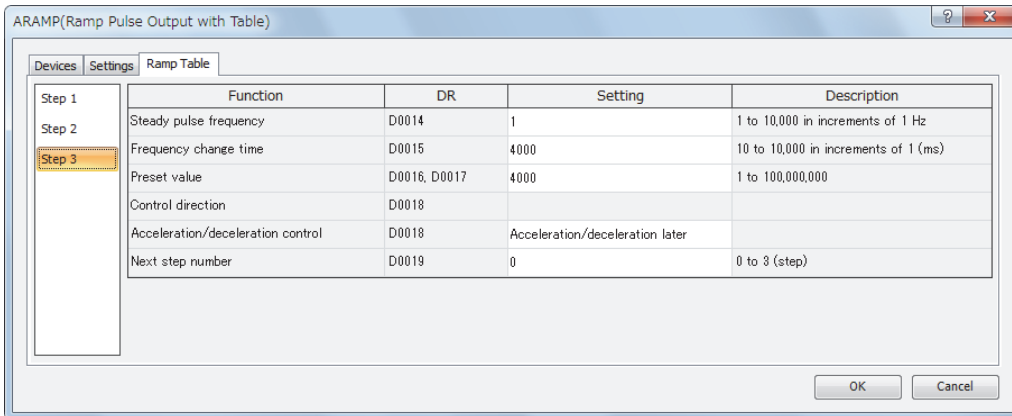

Function	Device address	Setting value	Details
Steady pulse frequency	D0014	1	1 Hz
Frequency change time	D0015	4000	4,000 msec
Preset value	D0016, D0017	4000	Preset value=4,000
Control direction	D0018	-	-
Acceleration/deceleration control	D0018	Acceleration/deceleration later	Acceleration/deceleration later=2
Next step number	D0019	2	0=End output

This section describes an example program that outputs pulses as shown below with the frequency change function (single-pulse output reversible control enabled) using the following settings. The pulses are output from Q14.

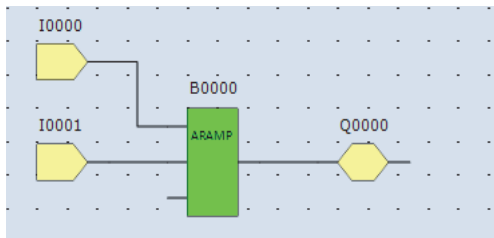
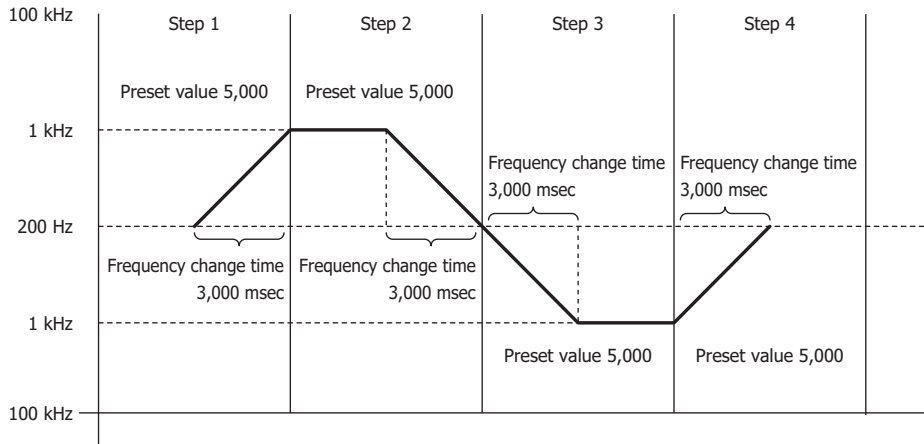

- When the ARAMP1 FB initialization input (I1) turns on, the control register value is initialized.
- When the ARAMP1 FB execution input (I0) turns on, pulse output starts.

Basic settings

Function	DR	Setting	Description
Operation mode		Mode 1: 200 Hz to 100 kHz	20 to 10,000 in increments of 1 (x10 Hz)
Reversible control enable		Single-pulse output	
Number of steps		4	1 to 18 steps
Start step number		1	1 to 4 (step)
Interrupt step number	D0000	1	1 to 4 (step)

Function	Device address	Setting value	Details
Operation mode	-	Mode 1	200 Hz to 100 kHz
Reversible control enable	-	Single-pulse output	-
Number of steps	-	4	-
Start step number	-	1	Step 1
Interrupt step number	D0000	-	-

Step 1 settings

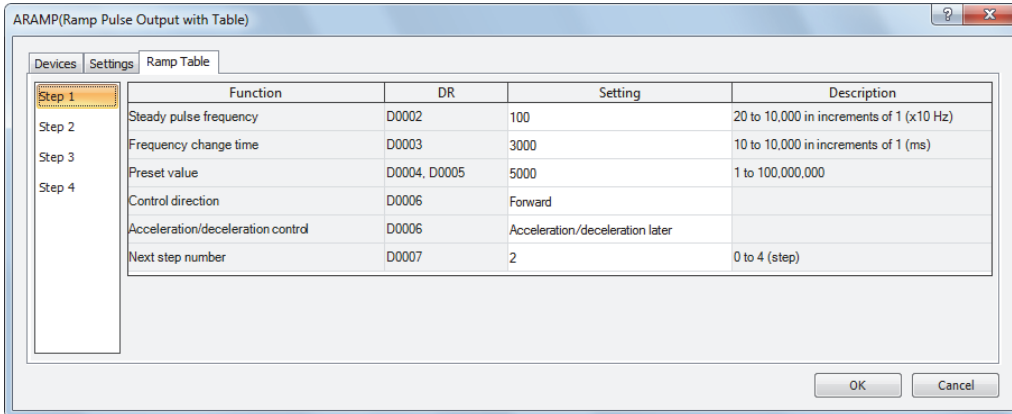

Function	Device address	Setting value	Details
Steady pulse frequency	D0002	100	1 kHz
Frequency change time	D0003	3000	3,000 msec
Preset value	D0004, D0005	5000	Preset value=5,000
Control direction	D0006	Forward	Forward = 0
Acceleration/deceleration control	D0006	Acceleration/deceleration later	Acceleration/deceleration later=2
Next step number	D0007	2	Step 2

Step 2 settings

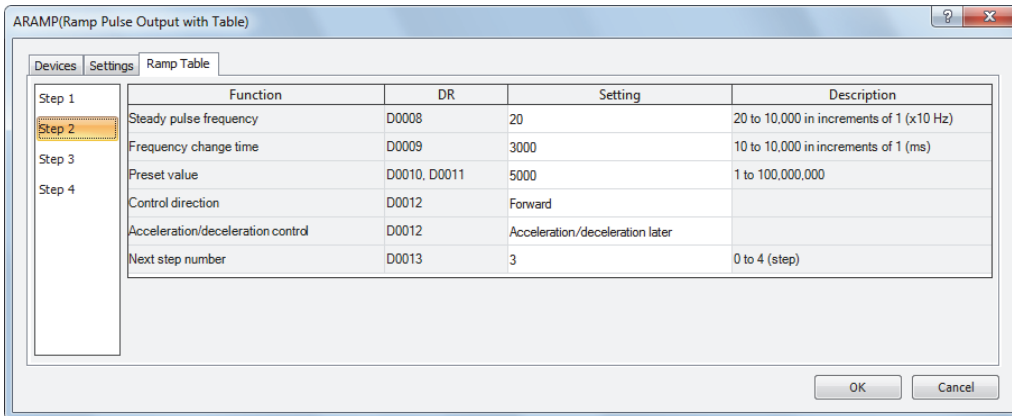

Function	Device address	Setting value	Details
Steady pulse frequency	D0008	20	200 Hz
Frequency change time	D0009	3000	3,000 msec
Preset value	D0010, D0011	5000	Preset value=5,000
Control direction	D0012	Forward	Forward = 0
Acceleration/deceleration control	D0012	Acceleration/deceleration later	Acceleration/deceleration later=2
Next step number	D0013	3	Step 3

Step 3 settings

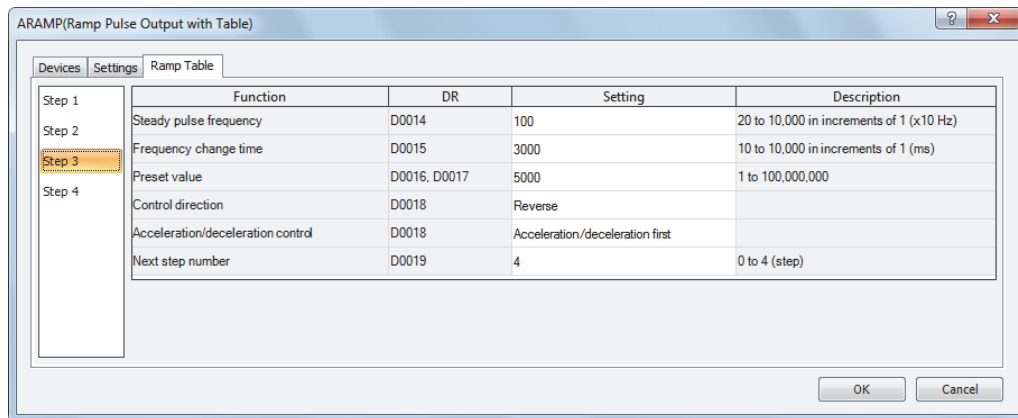

Function	Device address	Setting value	Details
Steady pulse frequency	D0014	100	1 kHz
Frequency change time	D0015	3000	3,000 msec
Preset value	D0016, D0017	5000	Preset value=5,000
Control direction	D0018	Reverse	Reverse = 1
Acceleration/deceleration control	D0018	Acceleration/deceleration first	Acceleration/deceleration first=0
Next step number	D0019	4	Step 4

Step 4 settings

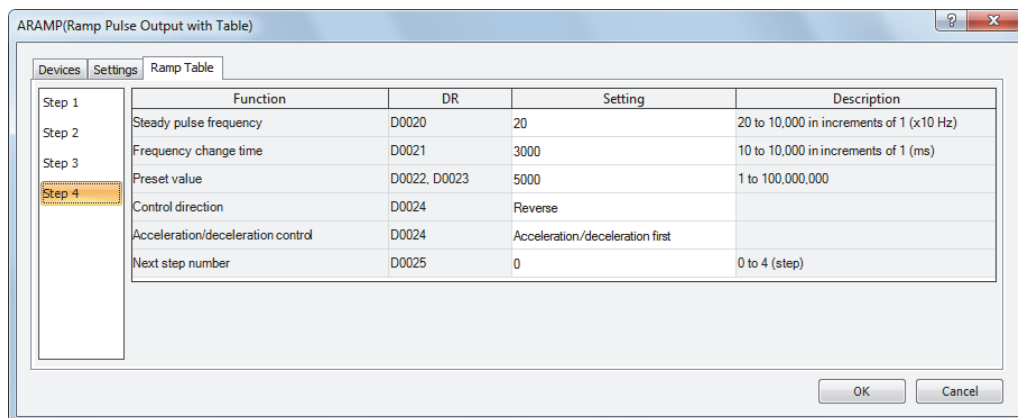

Function	Device address	Setting value	Details
Steady pulse frequency	D0020	20	200 Hz
Frequency change time	D0021	3000	3,000 msec
Preset value	D0022, D0023	5000	Preset value=5,000
Control direction	D0024	Reverse	Reverse = 1
Acceleration/deceleration control	D0024	Acceleration/deceleration first	Acceleration/deceleration first=0
Next step number	D0025	0	Step 0 (end)

15: THE PULSE FB

This section describes an example program that outputs pulses as shown below with the frequency change function (single-pulse output reversible control disabled) using the following settings. The pulses are output from Q14.

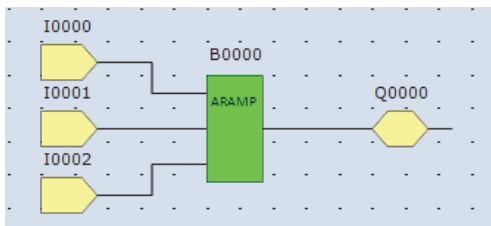
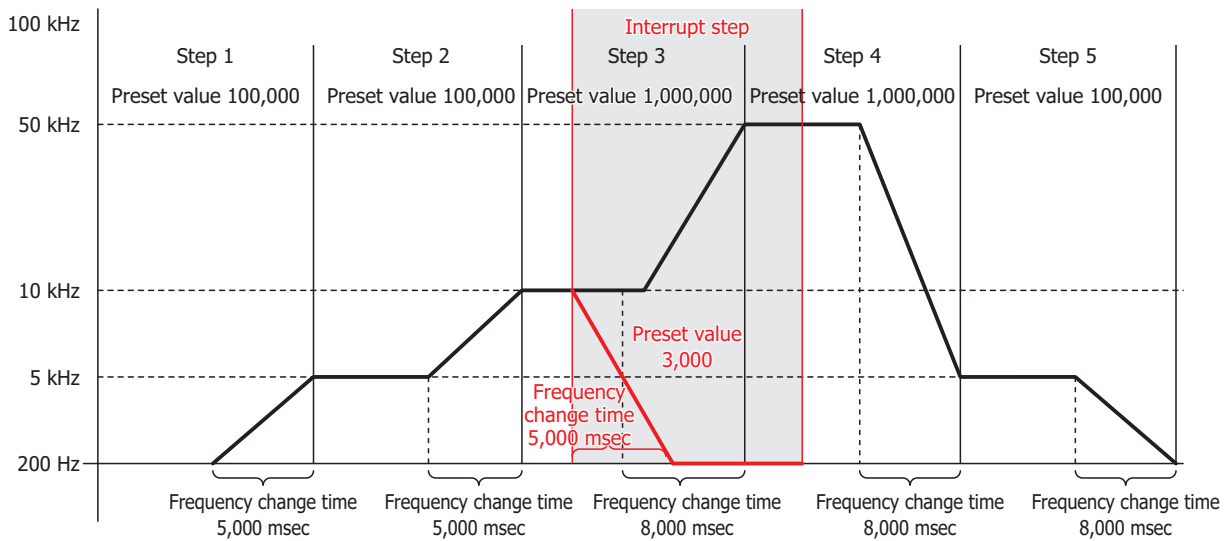

- When the initialization input (I1) turns on, the ARAMP1 FB control register value is initialized.
- When the ARAMP1 FB execution input (I0) turns on, pulse output starts.
- When the interrupt input (I2) turns on, the interrupt step is executed.

Basic settings

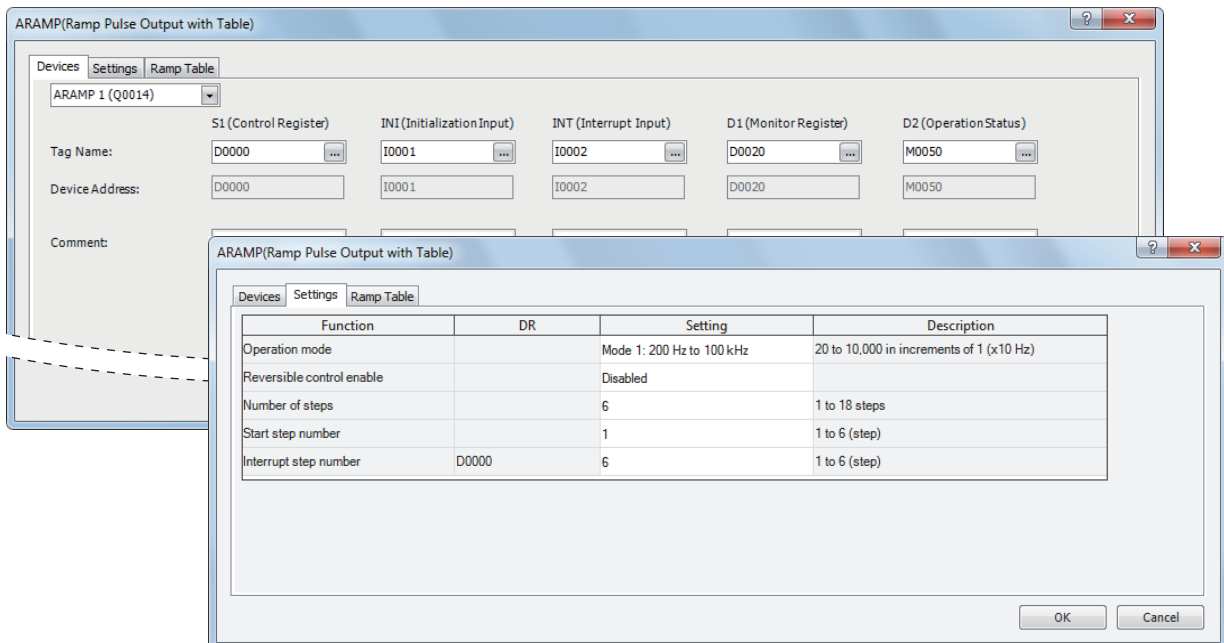

Function	Device address	Setting value	Details
Operation mode	–	Mode 1	200 Hz to 100 kHz
Reversible control enable	–	Disabled	–
Number of steps	–	6	–
Start step number	–	1	Step 1
Interrupt step number	D0000	6	Step 6

Step 1 settings

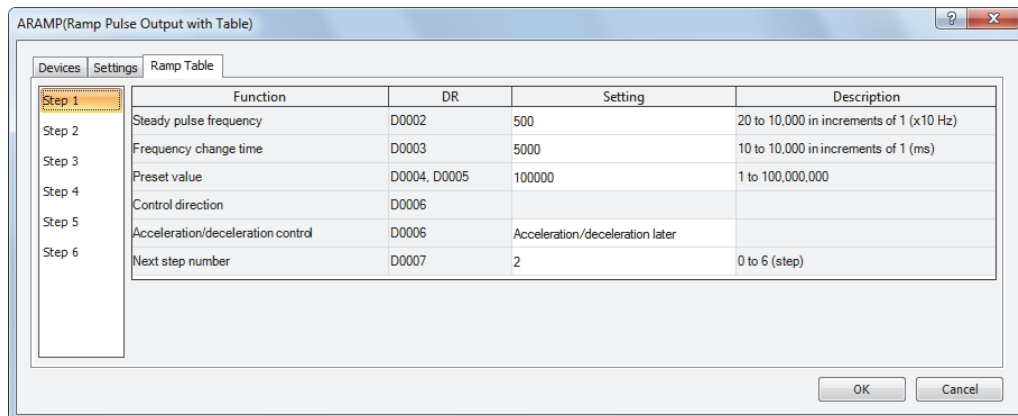

Function	Device address	Setting value	Details
Steady pulse frequency	D0002	500	5 kHz
Frequency change time	D0003	5000	5,000 msec
Preset value	D0004, D0005	100000	Preset value=100,000
Control direction	D0006	-	-
Acceleration/deceleration control	D0006	Acceleration/deceleration later	Acceleration/deceleration later=2
Next step number	D0007	2	Step 2

Step 2 settings

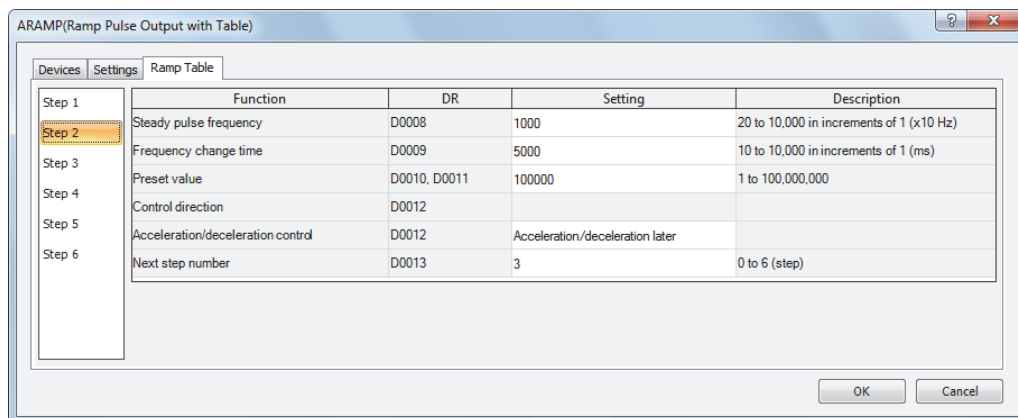

Function	Device address	Setting value	Details
Steady pulse frequency	D0008	1000	10 kHz
Frequency change time	D0009	5000	5,000 msec
Preset value	D0010, D0011	100000	Preset value=100,000
Control direction	D0012	-	-
Acceleration/deceleration control	D0012	Acceleration/deceleration later	Acceleration/deceleration later=2
Next step number	D0013	3	Step 3

Step 3 settings

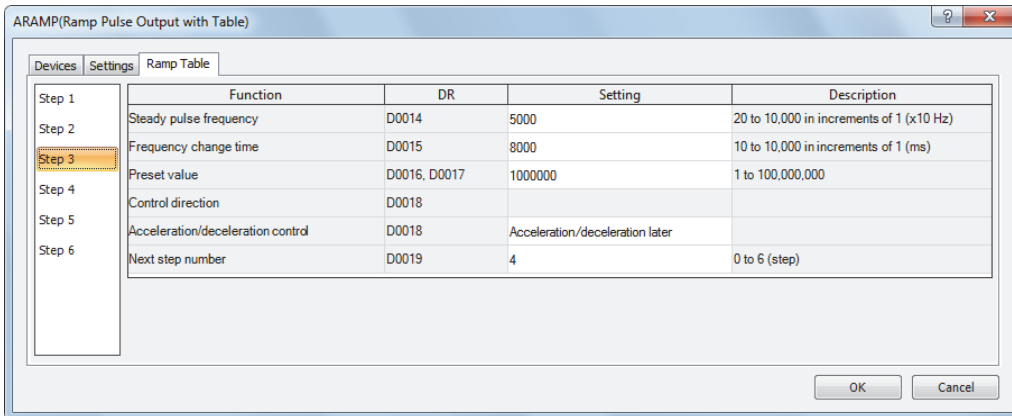

Function	Device address	Setting value	Details
Steady pulse frequency	D0014	5000	50 kHz
Frequency change time	D0015	8000	8,000 msec
Preset value	D0016, D0017	1000000	Preset value=1,000,000
Control direction	D0018	–	–
Acceleration/deceleration control	D0018	Acceleration/deceleration later	Acceleration/deceleration later=2
Next step number	D0019	4	Step 4

Step 4 settings

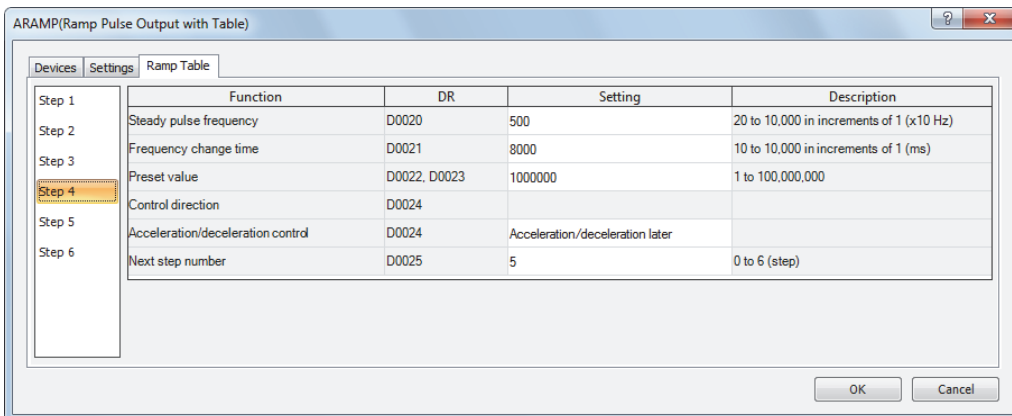

Function	Device address	Setting value	Details
Steady pulse frequency	D0020	500	5 kHz
Frequency change time	D0021	8000	8,000 msec
Preset value	D0022, D0023	1000000	Preset value=1,000,000
Control direction	D0024	–	–
Acceleration/deceleration control	D0024	Acceleration/deceleration later	Acceleration/deceleration later=2
Next step number	D0025	5	Step 5

Step 5 settings

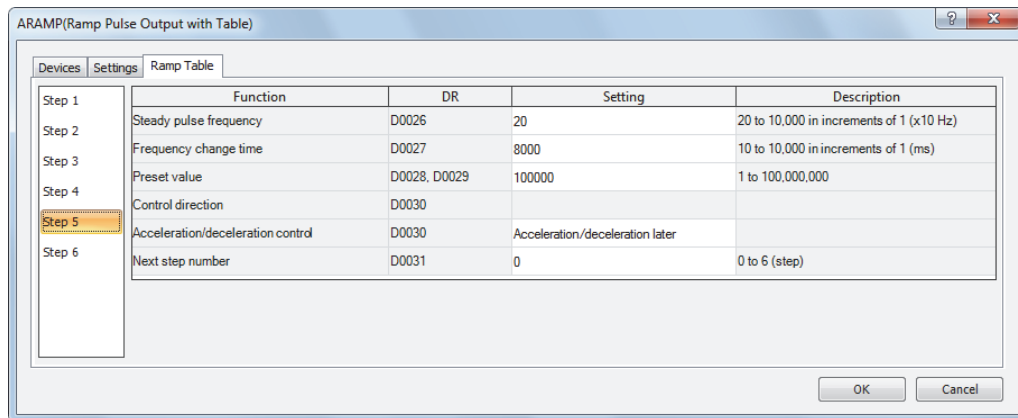

Function	Device address	Setting value	Details
Steady pulse frequency	D0026	20	200 Hz
Frequency change time	D0027	8000	8,000 msec
Preset value	D0028, D0029	100000	Preset value=100,000
Control direction	D0030	–	–
Acceleration/deceleration control	D0030	Acceleration/deceleration later	Acceleration/deceleration later=2
Next step number	D0031	0	0=End output

Step 6 settings

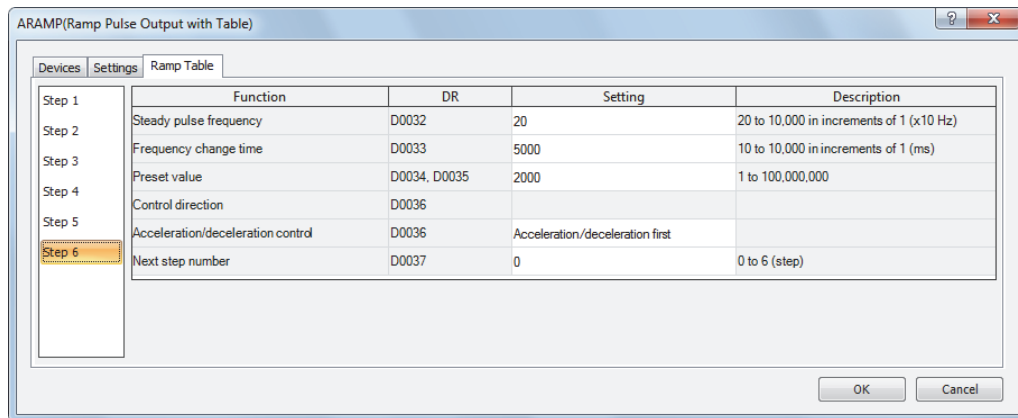

Function	Device address	Setting value	Details
Steady pulse frequency	D0032	20	200 Hz
Frequency change time	D0033	5000	5,000 msec
Preset value	D0034, D0035	2000	Preset value=2,000
Control direction	D0036	–	–
Acceleration/deceleration control	D0036	Acceleration/deceleration first	Acceleration/deceleration first=0
Next step number	D0037	5	Step 0 (end)

16: THE DATA LOGGING FB

The data logging function block saves log data for specified devices to the SD memory card.

DLOG (Data Log)

The DLOG FB saves the values of the specified devices in the specified data format as a CSV file to the SD memory card.

Symbol

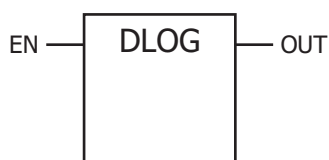

Operation

When the execution input (EN) turns on, the date and time and the value(s) of the specified device(s) are output to the CSV file in the specified folder. When the execution is finished, the completion output (OUT) is turned on and the execution status is stored in the specified device.

When the specified folder does not exist on the SD memory card, that folder is created. The folder path is "DATA0001\DATALOG\User specified folder." For details on the folder structure, see Chapter 5 "Special Functions" - "SD Memory Card" in the SmartAXIS Pro/Lite User's Manual.

The CSV file name is "DATE.csv." The date when the DLOG FB is turned on is used as DATE.

Example: If the date is September 30, 2011, the file name is "20110930.csv".

When a CSV file with the same date does not exist in the specified folder, the CSV file is created and the header and the log data is output.

Output example

Time	D0010	← Header
2011/09/07 08:30:23	12345	← Log data

When a CSV file with the same date already exists in the folder designated, only the log data is appended to the CSV file.

Output example

Time	D0010	
2011/09/07 08:30:23	12345	
2011/09/07 17:30:23	1212	← Appended log data

When the DLOG FB is finished executing, the completion output is turned on and the status code for the execution result is stored in the device specified by D1. For status codes, see "2. D1 (Execution Status)" on page 16-3.

Notes:

- The time required to create a new CSV file (create a file and output header) is 510 μs.
- When the SmartAXIS is started running after it is stopped and a DLOG FB is executed, the header is appended to the CSV file even if the same DLOG FB is executed previously within the same day.

Output example

Time	D0010	← Header
2011/09/07 08:30:23	12345	← Log data
Time	D0020	← Appended header
2011/09/07 17:30:23	1212	← Log data

- For details on the SD memory card specification, see Chapter 5 "Special Functions" – "SD Memory Card" in the SmartAXIS Pro/Lite User's Manual.

16: THE DATA LOGGING FB

Notes:

- The maximum number of DLOG FB that can be programmed in a user program is 48. However, make sure that the folder name specified by the DLOG FB is not conflicted with any folder names specified by the other DLOG FB. When the folders are conflicted, log data with a mixed format is output to the same CSV file.
- While the execution input to DLOG FB is on, log data is repeatedly output to the CSV file. When you want to output the log data only one time, add a SOTU (Shot up) or SOTD FB (Shot down function block) to the input condition. For SOTU or SOTD FB, see "The logical operation FB" on page 7-1 - "SOTU (Shot Up)" on page 7-8 and "SOTD (Shot Down)" on page 7-9.
- The data writing process to the SD memory card for the DLOG FB takes several scans. Once a DLOG FB is executed, the process continues until the log data transfer is complete, regardless of any change in the execution input to DLOG FB. While the log data is being written to the SD memory card, the DLOG FB is not executed, even when the execution input to DLOG FB is turned on. To execute the DLOG FB again, confirm that the previous data transfer process has finished, and then execute the DLOG FB.

Applicable SmartAXIS

FT1A-12	FT1A-24	FT1A-40	FT1A-48	FT1A Touch
-	-	X	X	-

Parameters

Parameter		Function	Range	Description
Number	B	Block number	B0 to B999	Unique number to identify each function block. The block number is automatically assigned in order from 0, but it can also be changed to the desired number. However, overlapping block numbers used in any other function blocks cannot be used.
	EN	Execution input	ON/OFF	When the execution input turns on, the date and time and the value(s) of the specified device(s) are output to the CSV file in the specified folder. When the execution input is off, the DLOG FB does not operate.
Output	OUT	Completion output	-	The completion output turns on when the data writing process and the execution of the DLOG FB are completed. This turns on regardless of the success or failure of output to the SD memory card.
Parameters	S1	Folder name	String ^{*1}	The SD memory card folder name.
	D1	Execution status	-	Specify the data register to store the status code. The status code is stored according to the DLOG FB execution status and result.

*1 Specify the SD memory card folder name as the desired text up to 8 single-byte alphanumeric characters.

Valid Devices

Parameter	Function	I	Q	M	R	T	TC	TP	C	CC	CP	B	D	AI	Constant
EN	Execution input	X	X	X	X	X	-	-	X	-	-	X	-	-	-
S1	Folder name ^{*1}	-	-	-	-	-	-	-	-	-	-	-	-	-	-
D1	Execution status	-	-	-	-	-	-	-	-	-	-	-	X ^{*2}	-	-

*1 Specify the folder name by entering characters.

*2 Special data registers cannot be designated.

Settings

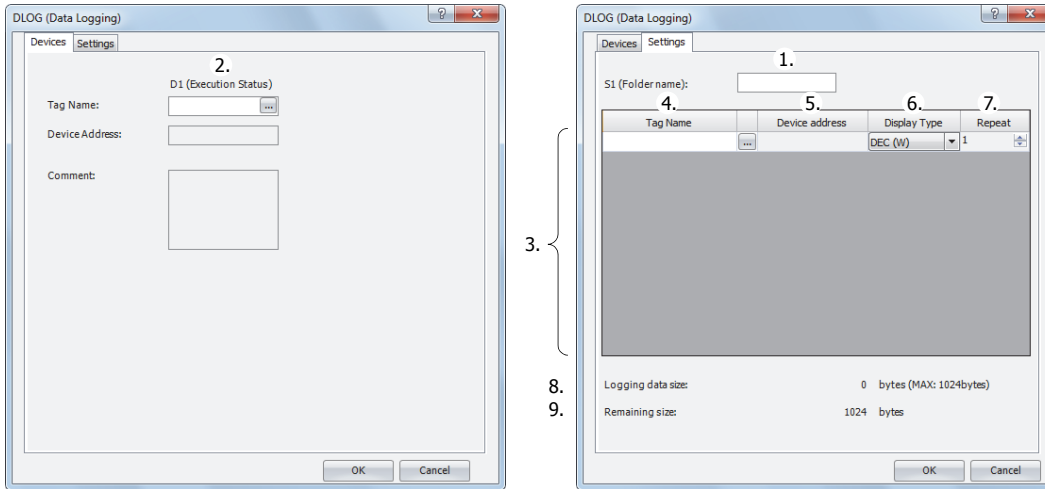

1. S1 (Folder name)

Specify the folder name on the SD memory card to store the log data with a desired text up to 8 single-byte alphanumeric characters.

Notes:

- The following single-byte characters cannot be used in the folder names:
/ \ : * ? " < > | # { } % & ~
- Consecutive periods cannot be used in folder names.
- A period cannot be used at the start or the end of the folder name.
- Single-byte spaces at the start or the end of the folder name are omitted.

2. D1 (Execution Status)

Specify the data register to store the status code. One of the following status codes is stored according to the DLOG FB execution status and result.

Status code	Status	Description
0	Normal	–
1	SD memory card insertion error	The SD memory card is not inserted
2	SD memory card capacity error	The SD memory card is full
3	SD memory card writing error	Writing log data to the SD memory card fails
4	CSV file capacity error	The CSV file exceeds 5 MB
5	SD memory card protection error	The SD memory card is write protected
6	SD memory card access error	DLOG FB is executed while another DLOG FB or TRACE FB is being executed
7	Characters conversion error	Converting log data to numeric characters fails
8	Folder creation error	Creating the folder fails
9	CSV file open error	Opening the CSV file fails
32	Executing DLOG FB	Writing log data to SD memory card is in progress

3. Settings

The list of log data to be output to the CSV files.

Display type	I	Q	M	R	T	TC	TP	C	CC	CP	B	D	AI
DEC(W)	–	–	–	–	–	X	X	–	X	X	–	X	–
DEC(I)	–	–	–	–	–	–	–	–	–	–	–	X	–
DEC(D)	–	–	–	–	–	–	–	–	X	X	–	X	–
DEC(L)	–	–	–	–	–	–	–	–	–	–	–	X	–
DEC(F)	–	–	–	–	–	–	–	–	–	–	–	X	–
HEX(W)	–	–	–	–	–	X	X	–	X	X	–	X	–
HEX(D)	–	–	–	–	–	–	–	–	X	X	–	X	–
BIN(B)	X	X	X	X	X	–	–	X	–	–	–	–	–

16: THE DATA LOGGING FB

4. Tag Name

Enter tag names or device addresses to specify the devices whose values are output to the CSV files.

5. Device Address

When the devices are specified as tag names, the corresponding device addresses are shown.

6. Display Type

Select the display type from the following table for each device for when the device values are output to the CSV file.

Display type	Range	Maximum characters
DEC(W)	0 to 65,535	5
DEC(I)	-32,768 to 32,767	6
DEC(D)	0 to 4,294,967,295	10
DEC(L)	-2,147,483,648 to 2,147,483,647	11
DEC(F)	-3.402823E+38 to 3.402823E+38	13
HEX(W)	0000 to FFFF	4
HEX(D)	00000000 to FFFFFFFF	8
BIN(B)	0 or 1	1

7. Repeat

The data in as many consecutive devices as the specified repeat, starting from the specified device address, are output to the SD memory card.

For example, when the display type of D10 is DEC(W) and the repeat is set to 5, the data is output to SD memory card as follows.

Time	D0010	D0011	D0012	D0013	D0014	← Header
2011/09/07 15:40:00	12345	1	5	12	111	← Log data 1
2011/09/07 15:41:00	1212	3	7	35	222	← Log data 2
2011/09/07 15:42:00	345	4	99	79	333	← Log data 3

8. Logging data size

The amount of memory that the DLOG FB uses for the current log settings is shown. The amount of memory used increases when a device to log the data is added. You can register up to a maximum of 64 devices (the total amount of memory must be less than or equal to 1,024 bytes). One byte of memory area is required for each character.

9. Remaining size

The amount of free memory (the difference between the logging data size and 1,024 bytes) is shown.

CSV File Output Format and File Format Configuration

The CSV file output format is as follows. You can change the separating character for each data and the decimal symbol for floating point numbers that are output to the CSV files on the Function Area Settings dialog box.

- **Output format**

```
Time,D0010,D0020,D0030,D0050,D0060
2011/09/07 15:40:00,12345,1,5,12,111
2011/09/07 15:41:00,1212,3,7,35,222
2011/09/07 15:42:00,345,4,99,79,333
.
.
.
```

When the DLOG FB is executed and the CSV file for the same date does not exist in the folder designated by S1, a new CSV file is created and the header and the log data 1 are output as shown in above output format example. If the DLOG FB is executed again on the same date, the log data 2 is appended to the CSV file. Similarly, if the DLOG FB is executed again on the same date, log data 3 is appended to the CSV file.

When the date changes and the DLOG FB is executed, a new CSV file with a new file name is created and the header and the log data is output.

File format configuration procedure

1. From the WindLDR menu bar, select **Configuration > Cartridges**.
2. Under **Data Log and Trace (CSV File Format)**, configure the separating character and the decimal symbol.
The separating characters and the decimal symbols that are contained in the CSV file vary by country and region. You can select the symbols to use from the following:
 - (1) Separating character: "," (comma) or ";" semicolon
 - (2) Decimal symbol: "." (period) or "," (comma)
3. Click the **OK** button to close the dialog box.

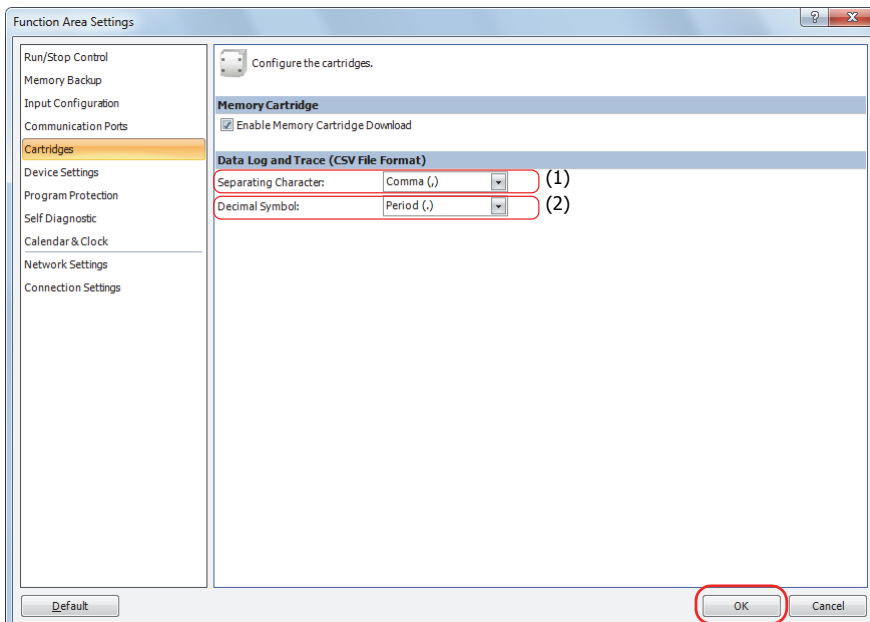

Examples: DLOG FB

When M0 is turned on, the decimal values of D0000 through D0005 (data type W (word)) and D0010 (data type F (floating point)) are saved in a CSV file in the "RESULT" folder on the SD memory card every 10 seconds.

Output example

Time	D0000	D0001	D0002	D0003	D0004	D0005	D0010
2012/02/06 10:20:30	12345	0	0	56789	0	0	-3.402823E+38
2012/02/06 10:20:40	12345	0	0	56789	0	0	-3.402823E+38
2012/02/06 10:20:50	12345	0	0	56789	0	0	-3.402823E+38

The sample user program operates as follows.

- B001 is turned on when the transfer of log data to the SD memory card is complete.
- The DLOG FB status code is stored in D100.
- The status code saved in D100 is checked and Q0 is turned on if an error occurs.

• Configuration Procedure

1. Insert each function block in the function block editor.

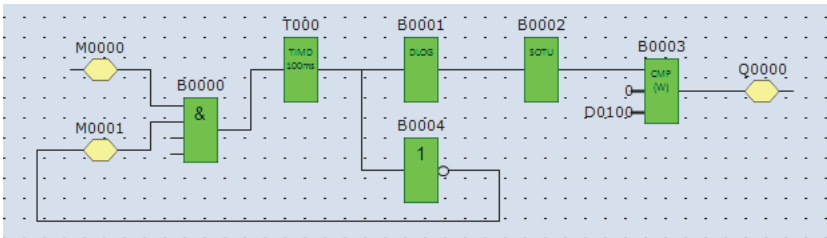

2. Configure the DLOG FB.

Configure the Devices tab.

(1) Designate D0100 as D1 (Execution Status).

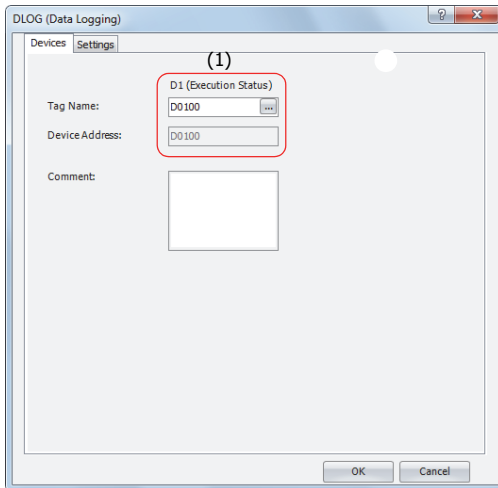

Configure the Settings tab.

- (2) Enter "RESULT" in S1 (Folder Name).
- (3) Configure D0000 to output the decimal value of D0000 to the CSV files with the data type W (word).
- (4) Set the repeat to 6 to output the values of D0000 through D0005 to the CSV files.
- (5) Configure D0010 to output the decimal value of D0010 to the CSV files with the data type F (float).

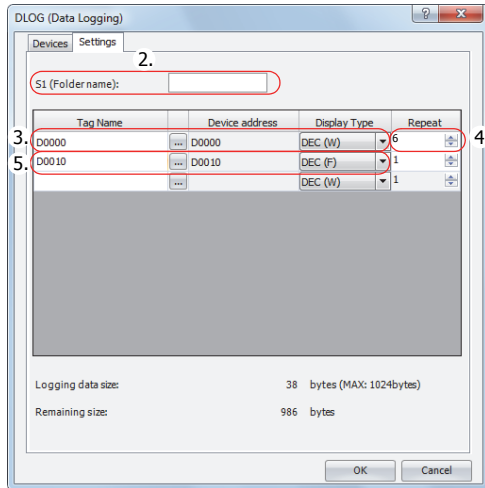

The configuration is now completed.

• **Operation Description**

In 10 seconds after M0000 is turned on, the DLOG FB is executed one time. When the DLOG FB is executed, the data of D0000 through D0005 and D0010 are output to the CSV file on the SD memory card as decimal values along with the current date and time.

The saved location of CSV files is DATA0001\DATALOG\RESULT. The oldest data is saved at the top of the log data, and the latest data is saved at the bottom of the log data.

When the execution of the DLOG FB is complete, the completion output of the DLOG FB is turned on and the CMP FB is executed once. The CMP FB compares the status code stored in the execution status D0100 with 0 and turns Q0 on or off. Q0 is turned on when an error occurs in the DLOG FB.

While M0 is on, the log data is appended to the CSV file every 10 seconds.

Output results

Time	D0000	D0001	D0002	D0003	D0004	D0005	D0010
2012/02/06 10:20:30	12345	0	0	56789	0	0	-3.402823E+38
2012/02/06 10:20:40	12345	0	0	56789	0	0	-3.402823E+38
2012/02/06 10:20:50	12345	0	0	56789	0	0	-3.402823E+38

TRACE (Data Trace)

The TRACE FB saves the values of the previous number of scans for the specified device in the specified data format as a CSV file to the SD memory card.

Symbol

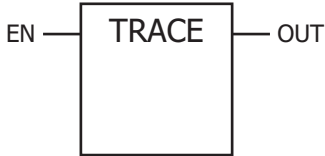

Operation

When the execution input (EN) turns on, the date and time and the value(s) of the previous numbers of scans for the specified device(s) are output to the CSV file in the specified folder. When the execution is finished, the completion output (OUT) is turned on and the execution status is stored in the specified device.

When the specified folder does not exist on the SD memory card, that folder is created. The folder path is "DATA0001\TRACE\User specified folder." For details on the folder structure, see Chapter 5 "Special Functions" - "SD Memory Card" in the SmartAXIS Pro/Lite User's Manual.

The CSV file name is "DATE.csv." The date when the TRACE FB is turned on is used as DATE.

Example: If the date is September 30, 2011, the file name is "20110930.csv".

When a CSV file with the same date does not exist in the folder designated by S1, the CSV file is created and the trace data is output. The oldest data is output at the top of the trace data, and the latest data is output at the bottom of the trace data.

Output example

Triggered at:	2012/02/06 08:30:23	← Header row 1
Scan	D0010	← Header row 2
Old	12345	← Data 2 scans before
	12345	← Data 1 scan before
New	12345	← Latest data

When a CSV file with the same date already exists in the folder designated by S1, the header and trace data are appended to the CSV file.

Output example

Triggered at:	2012/02/06 08:30:23	
Scan	D0010	
Old	12345	
	12345	
New	12345	
Triggered at:	2012/02/06 17:16:15	← Appended header row 1
Scan	D0010	← Appended header row 2
Old	1212	← Appended data 2 scans before
	1212	← Appended data 1 scan before
New	1212	← Appended latest data

When the TRACE FB is finished executing, the completion output is turned on and the status code for the execution result is stored in the device specified by D1. For status codes, see "2. D1 (Execution Status)" on page 16-10.

Notes:

- The TRACE instruction accumulates data while SmartAXIS is running but does not accumulate data when SmartAXIS is stopped.
- Data is accumulated while SmartAXIS is running even when the execution input to the TRACE FB is off.
- When the execution input to the TRACE FB is turned on, the accumulated data is output to the CSV file.
- The time required to create a new CSV file (create a file and output header) is 870 μs.

Notes:

- The maximum number of TRACE FB that can be programmed in a user program is three. Make sure that the folder name specified by the TRACE FB is not conflicted with any of the folder names specified by the other TRACE FB. When the folders are conflicted, trace data with a mixed format is output to the same CSV file.
- The number of scans of which the trace data can be saved to the CSV file when the TRACE FB is executed one time depends on the number of devices specified to trace and the display type for each device. For details, see "8. Trace data size" on page 16-11.
- While the execution input to the TRACE FB is on, the trace data is repeatedly output to the CSV file. When you want to output the trace data only one time, add a SOTU (Shot up) or SOTD FB (Shot down) to the input conditions. For SOTU (Shot up) or SOTD FB (Shot down function block), see "SOTU (Shot Up)" on page 7-8 and "SOTD (Shot Down)" on page 7-9.
- The data writing process to the SD memory card for the TRACE FB takes several scans. Once a TRACE FB is executed, the process continues until the trace data transfer is complete, regardless of any change in the execution input for TRACE FB. While the trace data is being written to the SD memory card, the TRACE FB is not executed even when the execution input to the TRACE FB are turned on. To execute the TRACE FB again, confirm that the previous data writing process has finished, and then execute the instruction.

Applicable SmartAXIS

FT1A-12	FT1A-24	FT1A-40	FT1A-48	FT1A Touch
-	-	X	X	-

Parameters

Parameter		Function	Range	Description
Number	B	Block number	B0 to B999	Unique number to identify each function block. The block number is automatically assigned in order from 0, but it can also be changed to the desired number. However, overlapping block numbers used in any other function blocks cannot be used.
	EN	Execution input	ON/OFF	When the execution input turns on, the date and time and the value(s) of the specified device(s) are output to the CSV file in the specified folder. When the execution input is off, the TRACE FB does not operate.
Output	OUT	Completion output	-	The completion output turns on when the data writing process and the execution of the TRACE FB are completed. This turns on regardless of the success or failure of output to the SD memory card.
Parameters	S1	Folder name	String ^{*1}	The SD memory card folder name.
	D1	Execution status	-	Specify the data register to store the status code. The status code is stored according to the TRACE FB execution status and result.

*1 Specify the SD memory card folder name as the desired text up to 8 single-byte alphanumeric characters.

Valid Devices

Parameter	Function	I	Q	M	R	T	TC	TP	C	CC	CP	B	D	AI	Constant
EN	Execution input	X	X	X	X	X	-	-	X	-	-	X	-	-	-
S1	Folder name ^{*1}	-	-	-	-	-	-	-	-	-	-	-	-	-	-
D1	Execution status	-	-	-	-	-	-	-	-	-	-	-	X ^{*2}	-	-

*1 Specify the folder name by entering characters.

*2 Special data registers cannot be designated.

Settings

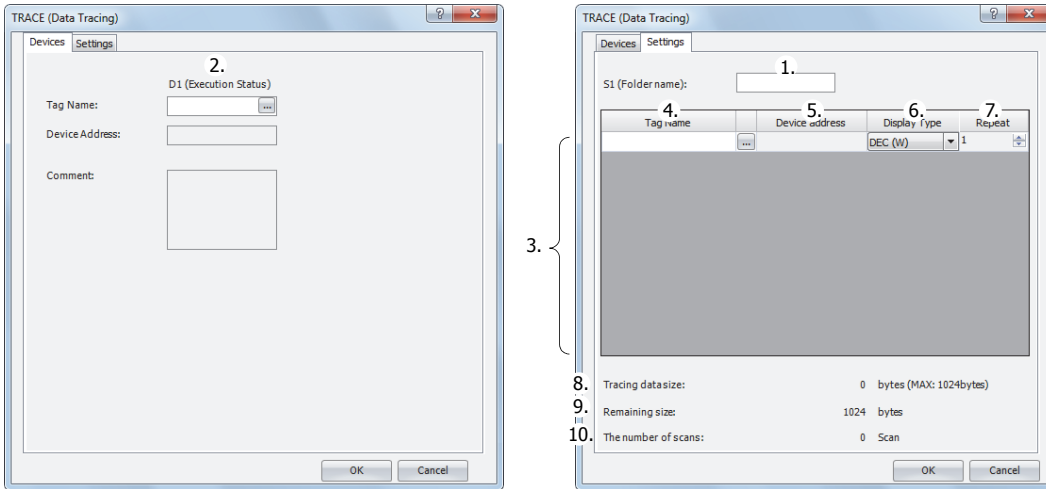

1. S1 (Folder name)

Specify the folder name on the SD memory card that will store the trace data with a desired text up to 8 single-byte alphanumeric characters.

Notes:

- The following single-byte characters cannot be used in folder names:
/ \ : * ? " < > | # { } % & ~
- Consecutive periods cannot be used in folder names.
- A period cannot be used at the start or the end of the folder name.
- Single-byte spaces at the start or the end of the folder name are omitted.

2. D1 (Execution Status)

Specifies the data register to store the status code. One of the following status codes is stored according to the TRACE FB execution status and result.

Status code	Status	Description
0	Normal	—
1	SD memory card insertion error	The SD memory card is not inserted
2	SD memory card capacity error	The SD memory card is full
3	SD memory card writing error	Writing trace data to the SD memory card fails
4	CSV file capacity error	The CSV file exceeds 5 MB
5	SD memory card protection error	The SD memory card is write protected
6	SD memory card access error	The TRACE FB is executed while another DLOG FB or TRACE FB is being executed
7	Characters conversion error	Converting trace data to numeric characters fails
8	Folder creation error	Creating the folder fails
9	CSV file open error	Opening the CSV file fails
32	Executing TRACE FB	Writing trace data to SD memory card is in progress

3. Settings

The list of trace data to be output to the CSV files.

Display type	I	Q	M	R	T	TC	TP	C	CC	CP	B	D	AI
DEC(W)	—	—	—	—	—	X	X	—	X	X	—	X	—
DEC(I)	—	—	—	—	—	—	—	—	—	—	—	X	—
DEC(D)	—	—	—	—	—	—	—	—	X	X	—	X	—
DEC(L)	—	—	—	—	—	—	—	—	—	—	—	X	—
DEC(F)	—	—	—	—	—	—	—	—	—	—	—	X	—
HEX(W)	—	—	—	—	—	X	X	—	X	X	—	X	—
HEX(D)	—	—	—	—	—	—	—	—	X	X	—	X	—
BIN(B)	X	X	X	X	X	—	—	X	—	—	—	—	—

4. Tag Name

Enter tag names or device addresses to specify the devices which values are output to the CSV files.

5. Device Address

When the devices are specified as tag names, the corresponding device addresses are shown.

6. Display Type

Select the display type from the following table for each device for when the device values are output to the CSV file.

Display type	Range	Maximum characters
DEC(W)	0 to 65,535	5
DEC(I)	-32,768 to 32,767	6
DEC(D)	0 to 4,294,967,295	10
DEC(L)	-2,147,483,648 to 2,147,483,647	11
DEC(F)	-3.402823E+38 to 3.402823E+38	13
HEX(W)	0000 to FFFF	4
HEX(D)	00000000 to FFFFFFFF	8
BIN(B)	0 or 1	1

7. Repeat

The data in as many consecutive devices as the specified repeat, starting from the specified device address, are output to the SD memory card.

For example, when the display type of D10 is DEC(W) and the repeat is set to 8, the data is output to SD memory card as follows.

Triggered at:	2011/9/7 15:40:30								← Header row 1
Scan	D0010	D0011	D0012	D0013	D0014	D0015	D0016	D0017	← Header row 2
Old	1	9	17	25	33	41	49	57	← Data 7 scans before
	2	10	18	26	34	42	50	58	← Data 6 scans before
	3	11	19	27	35	43	51	59	← Data 5 scans before
	4	12	20	28	36	44	52	60	← Data 4 scans before
	5	13	21	29	37	45	53	61	← Data 3 scans before
	6	14	22	30	38	46	54	62	← Data 2 scans before
	7	15	23	31	39	47	55	63	← Data 1 scan before
New	8	16	24	32	40	48	56	64	← Latest data

8. Trace data size

The amount of memory that the TRACE FB uses for the current trace settings is shown. The amount of memory used increases when a device to trace the data is added. You can register up to a maximum of 64 devices (the total amount of memory must be less than or equal to 1,024 bytes). One byte of memory area is required for each character.

9. Remaining size

The amount of free memory (the difference between the trace data size and 1,024 bytes) is shown.

10. The number of scans

How many scans of trace data can be accumulated with the current trace settings is shown. The number of scans of data that can be accumulated depends on the format of the trace data to output. If there is little data to output per scan, the data for many scans can be accumulated.

CSV File Output Format and File Format Configuration

The CSV file output format is as follows. You can change the separating character for each data and the decimal symbol for floating point numbers that are output to the CSV files on the Function Area Settings dialog box.

- **Output format**

```
Triggered at:.,2011/09/07 15:40:30
Scan,D0010,D0020,D0030,D0040,D0050,D0060,D0070,D0080
Old,1,9,17,25,33,41,49,57
,2,10,18,26,34,42,50,58
,3,11,19,27,35,43,51,59
,4,12,20,28,36,44,52,60
,5,13,21,29,37,45,53,61
,6,14,22,30,38,46,54,62
,7,15,23,31,39,47,55,63
New,8,16,24,32,40,48,56,64
:
:
```

When the TRACE FB is executed and the CSV file for the same date does not exist in the folder designated by S1, a new CSV file is created and the header and the trace data is output as shown in above output format example. When the date changes and the TRACE FB is executed, a new CSV file is created with a new file name.

File format configuration procedure

1. From the WindLDR menu bar, select **Configuration > Cartridges**.
2. Under **Data Log and Trace (CSV File Format)**, configure the separating character and the decimal symbol.
The separating characters and the decimal symbols that are contained in the CSV file vary by country and region. You can select the symbols to use from the following:
(1) Separating character: "," (comma) or ";" semicolon
(2) Decimal symbol: "." (period) or "," (comma)
3. Click the **OK** button to close the dialog box.

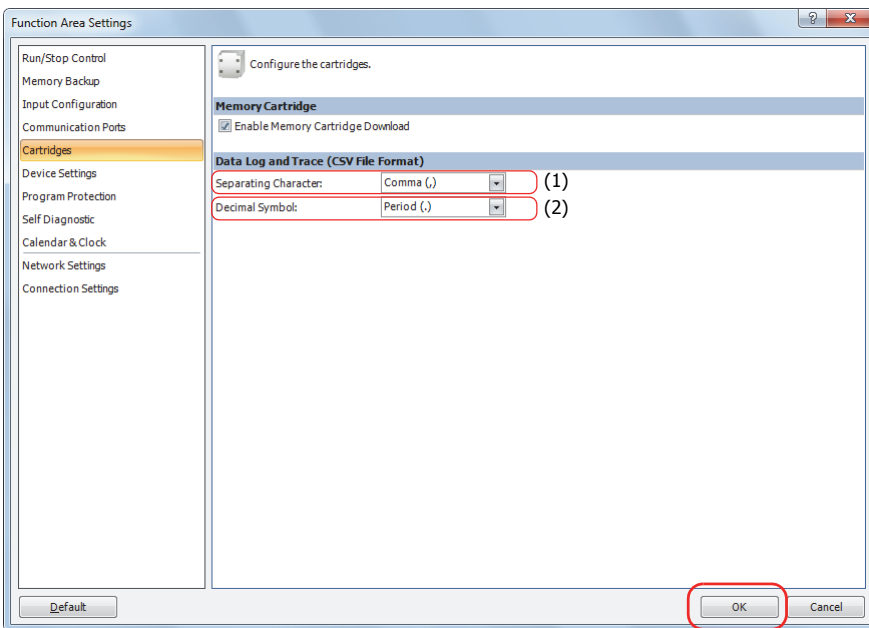

Examples: TRACE FB

When M0000 is turned on, the accumulated data of D0000 through D0005 (data type W (word)) and D0010 (data type F (floating point)) are saved as decimal values in a CSV file in the "RESULT" folder on the SD memory card.

Output sample

Triggered at:	2012/02/06 10:20:30						
Scan	D0000	D0001	D0002	D0003	D0004	D0005	D0010
Old	12345	2	12345	56789	1	56789	-3.402823E+38
	12345	2	12347	56789	1	56788	-3.402823E+38
	12345	2	12349	56789	1	56787	-3.402823E+38
:	:	:	:	:	:	:	:
	12345	2	12379	56789	1	56772	-3.402823E+38
	12345	2	12381	56789	1	56771	-3.402823E+38
New	12345	2	12383	56789	1	56770	-3.402823E+38

The sample user program operates as follows.

- B001 is turned on when the writing trace data to the SD memory card completes.
- The TRACE FB status code is stored to D100.
- The status code saved in D100 is checked and Q0 is turned on if an error occurs.

• Configuration Procedure

1. Insert each function block in the function block editor.

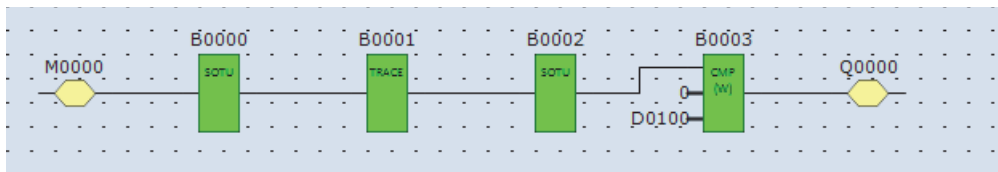

2. Configure the TRACE FB.

Configure the Devices tab.

(1) Designate D0100 as D1 (Execution Status).

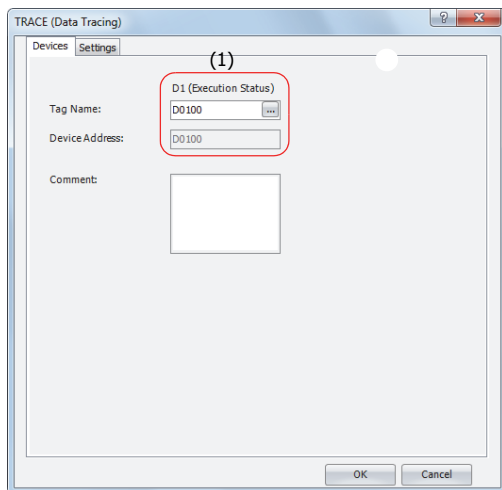

16: THE DATA LOGGING FB

Configure the Settings tab.

- (2) Enter "RESULT" in S1 (Folder Name).
- (3) Configure D0000 to output the decimal value of D0000 to the CSV files with the data type W (word).
- (4) Set the repeat to 6 to output the values of D0000 through D0005 to the CSV files.
- (5) Configure D0010 to output the value of D0010 to the CSV files with the data type F (float).

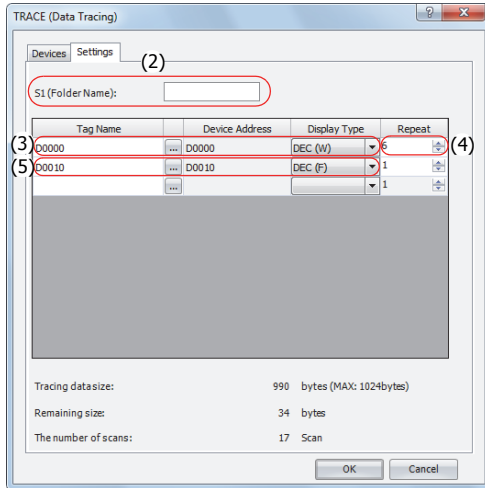

The configuration is now completed.

• Operation Description

When M0000 is turned on, the TRACE FB is executed one time. When the TRACE FB is executed, the data of D0000 through D0005 and D0010 in the previous 17 scans are output to a CSV file on the SD memory card as decimal values along with the date and time of the execution.

The saved location of CSV files is DATA0001\TRACE\RESULT. The oldest data is saved at the top of the trace data, and the latest data is saved at the bottom of the trace data.

When the execution of the TRACE FB completes, the completion output of the TRACE FB is turned on and the CMP FB is executed once. The CMP FB compares the status code stored in the execution status D0100 with 0 and turns Q0 on or off. Q0 is turned on when an error occurs in the TRACE FB.

Output results

Triggered at:	2012/02/06 10:20:30						
Scan	D0000	D0001	D0002	D0003	D0004	D0005	D0010
Old	12345	2	12345	56789	1	56789	-3.402823E+38
	12345	2	12347	56789	1	56788	-3.402823E+38
	12345	2	12349	56789	1	56787	-3.402823E+38
	12345	2	12351	56789	1	56786	-3.402823E+38
	12345	2	12353	56789	1	56785	-3.402823E+38
	12345	2	12355	56789	1	56784	-3.402823E+38
	12345	2	12357	56789	1	56783	-3.402823E+38
	12345	2	12359	56789	1	56782	-3.402823E+38
	12345	2	12361	56789	1	56781	-3.402823E+38
	12345	2	12363	56789	1	56780	-3.402823E+38
	12345	2	12365	56789	1	56779	-3.402823E+38
	12345	2	12367	56789	1	56778	-3.402823E+38
	12345	2	12369	56789	1	56777	-3.402823E+38
	12345	2	12371	56789	1	56776	-3.402823E+38
	12345	2	12373	56789	1	56775	-3.402823E+38
	12345	2	12375	56789	1	56774	-3.402823E+38
New	12345	2	12377	56789	1	56773	-3.402823E+38

17: THE SCRIPT FB

The script enables you to program complicated processing with conditional branching, logical operations, arithmetic operations, and functions in the scripting language.

Created scripts are executed by specifying their ID in script FBs.

SCRPT (Script)

Executes the script with the specified ID.

Symbol

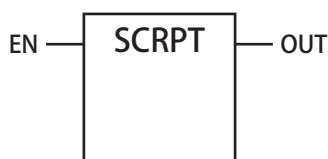

Operation

When the execution input (EN) is on, the script that corresponds to the script ID specified by S1 is executed.

When script execution is complete, the execution status and the execution time are stored in the specified data registers, and the output (OUT) turns on for 1 scan. To use the SCRPT FB, you must create a script in Script Manager beforehand. For details about the scripts executed by the SCRPT FB, refer to the following pages.

[Script function overview]

- See Chapter 13 "Scripts" - "Script Function Overview" in the SmartAXIS Pro/Lite User's Manual.
- See Chapter 20 "Scripts" - "1.1 Script Function Overview" in the SmartAXIS Touch User's Manual.

[Script editing]

- See Chapter 13 "Scripts" - "Script Editing and Management" in the SmartAXIS Pro/Lite User's Manual.
- See Chapter 20 "Scripts" - "2 Script Editing and Management" in the SmartAXIS Touch User's Manual.

Applicable SmartAXIS

FT1A-12	FT1A-24	FT1A-40	FT1A-48	FT1A Touch
X	X	X	X	X

Parameters

Parameter	Function	Range	Description	
Number	B	Block number	B0 to B999 *1	Unique number to identify each function block. The block number is automatically assigned in ascending order from zero. The block number can be changed to a desired number. However, the block numbers already used in any other FBs cannot be used.
Input	EN	Execution input	On/off	When the execution input is on, the script that corresponds to the script ID is executed.
Output	OUT	Output	–	When the script execution is complete, the output turns on for 1 scan.
Parameters	S1	Script ID	1 to 255	The ID of the script to execute when the execution input is on. The value can be specified as a constant or a data register.*2
	D1	Execution result	D0 to D998, D1000 to D1998*3	Specifies the data register where the execution result is stored. 2 words are used starting from the specified data register.

*1 B0 to B199 for the 12-I/O type.

*2 For a constant, specify the value in the range of 1 to 255. To indirectly specify the value with a data register, specify it with the data register number where the value is stored, and specify the content of the data register in the range of 1 to 255.

*3 D0 to D398 for the 12-I/O type.

17: THE SCRIPT FB

Valid Devices

Parameter	Function	I	Q	M	R	T	TC	TP	C	CC	CP	B	D	AI	Constant
EN	Execution input	X	X	X	X	X	-	-	X	-	-	X	-	-	-
S1	Script ID	-	-	-	-	-	-	-	-	-	-	-	X	-	X
D1	Execution result	-	-	-	-	-	-	-	-	-	-	-	X	-	-

1) S1: Script ID

Specifies the script ID. A constant or data register can be specified.

2) D1: Execution result

The execution status and the execution time are stored in 2 consecutive data registers starting from the specified data register number. The range of available data register numbers is D0 to D998 and D1000 to D1998.

Storage destination	Description
D1	The script execution status (error code at script completion) is stored.
D1+1	The execution time from when the script starts executing until it completes is stored in 100 μ s increments.

Execution status

Numeric value	Status	Description
0	Normal termination	-
1	Arithmetic error	Divide by zero, floating point format error
2	Script ID error	The specified script does not exist
3	Device access error	Invalid device specified, device boundary exceeded

If an arithmetic error or a device access error occurs, script processing is canceled immediately and the execution of the SCRPT FB is terminated. If the script ID error occurs, only D1 and D1+1 are updated and the execution of the SCRPT FB is terminated.

Execution time

The execution time from when the specified script starts executing until it completes is stored in 100 μ s increments.

Example: • If it takes 1.45 ms for the specified script to complete, 15 is stored as the execution time.

- If it takes 6553.5 ms or longer for the specified script to complete, 65535 is stored as the execution time.

The SCRPT FB execution time is affected by interrupt processing and other processing that occurs during the script execution. If any error occurs other than the script ID error, the script execution time from when the script starts execution until the error occurs is stored as the execution time. If the script ID error occurs, 0 is stored as the execution time.

Script Selection

To specify a registered script ID for S1, select the SCRPT FB and click ... button displayed to the right of S1 in the Property Sheet to open the Script Manager dialog box. Select the script and click **Select** button, and then the selected script ID is entered to S1 of the SCRPT FB.

18: THE SPECIAL FB

The special FB includes the high-speed counter and the flip-flop FBs.

HSC (High-speed Counter)

Controls the specified high-speed counter configured in the function area settings. The HSC FB turns on/off gate input, reset input, and clear input of the high-speed counter.

Symbol

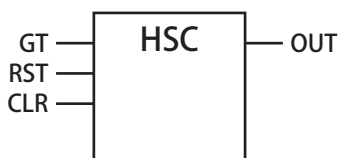

Operation

The HSC FB controls the gate input, reset input, and clear input of the high-speed counter.

When the reset input (RST) is off and the gate input (GT) is turned on, the counting begins for the incoming pulses to the pulse input of the high-speed counter. When the current value reaches to the preset value, the output (OUT) is turned on for 1 scan. The high-speed counter settings are configured in the Function Area Settings dialog box in WindLDR. The reset value or the initial values in control registers can be configured using other FBs such as SCRPT FB.

For details on the high-speed counter, see the following manuals.

- Chapter 5 "Special Functions" - "High-speed Counter" in the "SmartAXIS Pro/Lite User's Manual"
- Chapter 3 "Projects" - "4 Special Functions" - "4.7 High-speed Counter" in the "SmartAXIS Touch User's Manual"

Applicable SmartAXIS

FT1A-12	FT1A-24	FT1A-40	FT1A-48	FT1A Touch
X	X	X	X	X

Parameters

Parameter	Function	Range	Description	
Number	B	Block number	B0 to B999 *1	Unique number to identify each function block. The block number is automatically assigned in ascending order from zero. The block number can be changed to a desired number. However, the block numbers already used in any other FBs cannot be used.
Input	GT	Gate input	On/off	When the gate input is on, the high-speed counter performs the counting operation. When the gate input is off, the high-speed counter does not perform the counting operation.
	RST	Reset input	On/off	When the reset input is on, the reset value is stored in the current value. When unconnected, the input is handled as off.
	CLR	Clear input	On/off	When the clear input is on, the external comparison output*2 is turned off. When unconnected, the input is handled as off.
Output	OUT	Output	-	The output operates according to the comparison action configured in the High-speed Counter Settings dialog box of WindLDR. (1) When the comparison output is disabled, the output is always off. (2) When the comparison output is enabled, the output is turned on for 1 scan when the current value reaches to the preset value. When the current value is not equal to the preset value, the output is off.
Parameters	OP	High-speed counter group	1 to 6	Specifies the high-speed counter group.*3 Set this value as a constant.

*1 B0 to B199 for the 12-I/O type.

*2 For details on the external comparison output, see the following manuals.

- Chapter 5 "Special Functions" - "High-speed Counter" in the "SmartAXIS Pro/Lite User's Manual"
- Chapter 3 "Projects" - "4 Special Functions" - "4.7 High-speed Counter" in the "SmartAXIS Touch User's Manual"

*3 Specify the group number of the high-speed counter configured in WindLDR. The high-speed counter does not operate when the high-speed counter is not configured for the specified group. The valid range of the group number differs with each SmartAXIS series.

18: THE SPECIAL FB

SmartAXIS	Range
12-I/O type	1 to 4
24-, 40-, 48-I/O types	1 to 6
Touch	1 to 5

Valid Devices

Parameter	Function	I	Q	M	R	T	TC	TP	C	CC	CP	B	D	AI	Constant
GT	Gate input	X	X	X	X	X	-	-	X	-	-	X	-	-	-
RST	Reset input	X	X	X	X	X	-	-	X	-	-	X	-	-	-
CLR	Clear input	X	X	X	X	X	-	-	X	-	-	X	-	-	-

Detailed description

Before starting the counting operation, store the initial values in the reset value in the special data registers and the next preset value number and preset values in the control registers using other FBs such as SCRPT FB.

Turn on the reset input (RST) to store the reset value in the current value. Turn off the reset input once resetting the current value is finished.

When the gate input (GT) is turned on, the counting operation begins.

The preset values are stored in the control registers. The preset value specified with the current preset value number is active. The active preset value number for the current comparison is stored in the current preset value number. The preset value number to be active after the current comparison is automatically stored in the next preset value number. By changing the value in the next preset value number, the preset value to be active after the current comparison can be changed.

While the gate input is on, the preset value and current value are compared. Once the values equal, the output (OUT) is turned on for 1 scan. When the gate input is off, the high-speed counter does not perform the counting operation, and the output is turned off.

Notes:

- When using the high-speed counter, High-speed Counter must be configured in **Configuration > Function Area Settings > Input Configuration > Special Input** in WindLDR. For details, see the following manuals.
 - Chapter 5 "Special Functions" - "High-speed Counter" in the "SmartAXIS Pro/Lite User's Manual"
 - Chapter 3 "Projects" - "4 Special Functions" - "4.7 High-speed Counter" in the "SmartAXIS Touch User's Manual"
- The special internal relays for the gate input, reset input, and clear input cannot be directly manipulated. Use the HSC FB.

RSFF (RS Flip-flop)

The output is turned on with the set input and maintained until the reset input is turned on.

Symbol

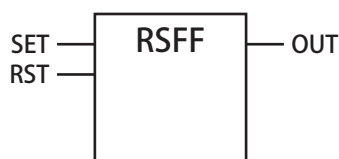

Operation

When the set input (SET) is on, the output (OUT) is turned on. When the reset input (RST) is on, the output is turned off. The reset input is executed with a higher precedence than the set input. When the reset input is on, the output is turned off regardless of the on/off state of the set input.

Applicable SmartAXIS

FT1A-12	FT1A-24	FT1A-40	FT1A-48	FT1A Touch
X	X	X	X	X

Parameters

Parameter	Function	Range	Description
Number	B	Block number	B0 to B999 *1
Input	SET	Set input	On/off
	RST	Reset input	On/off
Output	OUT	Output	–
Parameters	–	–	–

*1 B0 to B199 for the 12-I/O type.

*2 For the output logic, see the table below.

Set input	Reset input	Output	Description
0	0	–	The output does not change.
0	1	0	The output is reset.
1	0	1	The output is set.
1	1	0	The output is reset (the reset input is executed with a higher precedence than the set input).

Valid Devices

Parameter	Function	I	Q	M	R	T	TC	TP	C	CC	CP	B	D	AI	Constant
SET	Set input	X	X	X	X	X	–	–	X	–	–	X	–	–	–
RST	Reset input	X	X	X	X	X	–	–	X	–	–	X	–	–	–

Timing Chart

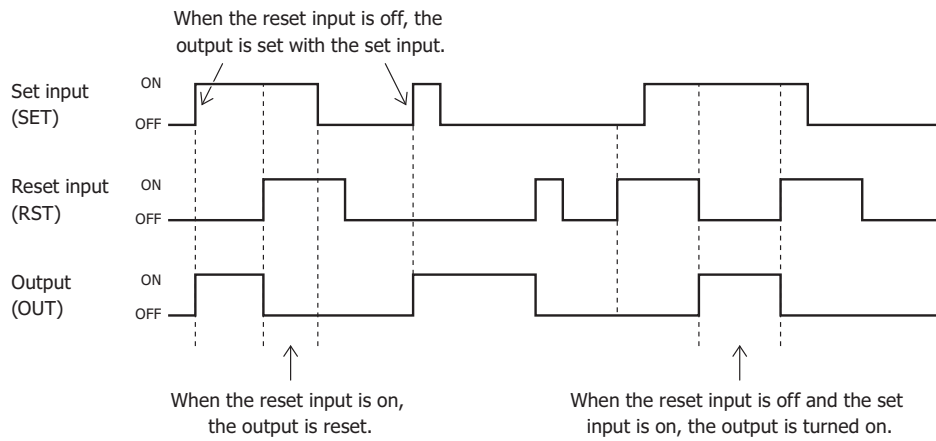

When the reset input (RST) is off and the set input (SET) is turned on, the output (OUT) is turned on. The output state is maintained even after the set input is turned off. Once the reset input (RST) is turned on, the output is turned off.

When the reset input is on, the output is not turned on even if the set input is turned on. When the set input and the reset input are both on and the reset input is turned off, the output is turned on.

APPENDIX

This chapter describes details on FBD program processing, FB execution time, and the byte count for FBs.

Processing in One Scan

While the SmartAXIS is running, the SmartAXIS continue to perform operations such as input refreshing, FBD program processing, and error checking. The execution of such a set of processing is defined as a *scan*. The time required for this execution is referred to as one *scan time*. The scan time varies depending on the created FBD program.

The current value of the scan time is stored to special data register D8023 (scan time current value), and the maximum value of the scan time is stored to special data register D8024 (scan time maximum value).

FBD Program Processing

In FBD programs, all of the FBs connected to the output FB (digital output FB or internal relay FB) are executed sequentially from the input FBs. The FBD program processing time in one scan is approximately equal to the total of execution time of each FB.

For the execution time of each FB, refer to "FB Execution Time" on page A-2".

If the processing time for one scan exceeds the specified time for the watchdog timer, a watchdog timer error occurs and the system is reset. For details on the watchdog timer, see the following manuals.

Chapter 5 "Special Functions" - "Watchdog Timer Setting" in the SmartAXIS Pro/Lite User's Manual

Chapter 3 "Project" - "4 Special Functions" - "4.14 Watchdog Timer Setting" in the SmartAXIS Touch User's Manual

Scan End Processing Time

After processing the FBD program, the SmartAXIS processes housekeeping operations at the end of each scan. It is referred to as Scan End processing. This includes the operations such as I/O refreshing and error checking.

Item	Processing Time
Scan End Processing	1 msec min.

FB Execution Time

Group	FB		Device and Condition	Execution time (μsec)	
	Name	Symbol		Pro/Lite	Touch
Logical Operation	Logical AND	AND	–	28.9	73.0
	Negative Logical AND	NAND	–	28.9	73.2
	Logical OR	OR	–	29.0	73.2
	Negative Logical OR	NOR	–	29.0	73.0
	Exclusive Logical OR	XOR	–	28.8	72.6
	Negative Exclusive Logical OR	XNOR	–	28.8	72.8
	Negation	NOT	–	26.8	70.8
	Shot Up	SOTU	–	27.6	72.6
	Shot Down	SOTD	–	27.6	72.8
	Truth Table	TRUTH	–	28.4	73.4
Timer	On-delay Count Up Timer	TIMU	–	30.0	74.8
	On-delay Count Down Timer	TIMD	–	29.9	74.6
	Off-delay Count Up Timer	TIMOU	–	30.0	75.0
	Off-delay Count Down Timer	TIMOD	–	30.0	75.0
	On/off-delay Timer	TIMCU	–	31.5	77.4
	Single Shot Pulse	SPULS	–	42.8	74.8
	Dual Timer	DTIM	–	28.0	72.2
	Random Pulse Output	RPULS	–	33.5	95.0
Counter	Adding Counter	CNT	W (Word)	30.8	75.0
			D (Double word)	41.8	152.0
	Up/Down Selection Reversible Counter	CUD	W (Word)	30.9	75.6
			D (Double word)	38.2	126.8
	Hour Meter	HOUR	–	32.7	94.6
Shift Register	Shift Register	SFR	–	23.3	50.8
Data Comparison	Data Comparison	CMP	–	30.0	82.0
	Schmitt Trigger	STTG	–	28.8	79.8
	Range Comparison	RCMP	–	28.1	81.6
Data Conversion	Alternate Output	ALT	–	26.4	59.2
Week Programmer	Weekly Timer	WEEK	–	37.8	112.8
	Yearly Timer	YEAR	–	38.0	113.6
Interface	Message	MSG	–	27.7	–
Pulse	Pulse Output	PULS	–	33.0	–
	Pulse Width Modulation	PWM	–	33.0	–
	Ramp Pulse Output	RAMP	–	30.9	–
	Zero Return	ZRN	–	30.9	–
	Advanced Ramp	ARAMP	–	56.0	–
Data Logging	Data Log	DLOG	–	–	–
	Data Trace	TRACE	–	–	–
Script	Script	SCRPT	–	–	–
Special	High-speed Counter	HSC	–	29.3	159.0
	RS Flip-flop	RSFF	–	24.9	53.2

FBD Program Size

When FBD is selected as the programming language, you are able to create a FBD program with a maximum size of 38,000 bytes (For the 12-I/O type, the FBD program can be created with a maximum size of 10,000 bytes).

There are also limitations on the number of FBs that can be used in a single FBD program. Even if the size of the FBD program is less than the maximum size, FBs cannot be added to the program when the maximum number of FBs are already used in the program.

The maximum size of FBD program and the maximum number of FBs are as follows.

		12-I/O Type	24-I/O, 40-I/O, 48-I/O Types
Maximum size of FBD program		10,000 bytes	38,000 bytes
Maximum number of blocks, timers, and counters that can be used in the FBD program*1	Block (B)	200	1,000
	Timer (T)	100	200
	Counter (C)	100	200

*1 Some FBs use more than one device. For details about each FB, see the description from Chapter 5 "The input FB" through Chapter 18 "The special FB".

The size of the FBD program is the total of the size of all FBs used in the FBD program.

The number of Block (B) is the total number of FBs that use blocks (B) in the program. The number of Timer (T) and Counter (C) is the total number of devices used by the timer and counter FBs in the program. The number of Timer (T) and Counter (C) does not match the number of timer and counter FBs in the program.

The size (quantities of bytes) and the number of used devices of FBs are listed below.

FB Size List

Group	FB		Qty of Bytes	Device type	Number of Used devices
	Name	Symbol			
Logical Operation	Logical AND	AND	12	B	1
	Negative Logical AND	NAND	12		1
	Logical OR	OR	12		1
	Negative Logical OR	NOR	12		1
	Exclusive Logical OR	XOR	8		1
	Negative Exclusive Logical OR	XNOR	8		1
	Negation	NOT	8		1
	Shot Up	SOTU	8		1
	Shot Down	SOTD	8		1
	Truth Table	TRUTH	16		1
Timer	On-delay Count Up Timer	TIMU	8	T	1
	On-delay Count Down Timer	TIMD	8		1
	Off-delay Count Up Timer	TIMOU	12		1
	Off-delay Count Down Timer	TIMOD	12		1
	On/off-delay Timer	TIMCU	12		2
	Single Shot Pulse	SPULS	12		1
	Dual Timer	DTIM	12		3
	Random Pulse Output	RPULS	12		3
Counter	Adding Counter	CNT(W)	12	C	1
		CNT(D)	12		2
	Up/Down Selection Reversible Counter	CUD(W)	16		3
		CUD(D)	16		6
	Hour Meter	HOUR	12		3

APPENDIX

Group	FB		Qty of Bytes	Device type	Number of Used devices
	Name	Symbol			
Shift Register	Shift Register	SFR	16	B	1
Data Comparison	Data Comparison	CMP	16		1
	Schmitt Trigger	STTG	20		1
	Range Comparison	RCMP	20		1
Data Conversion	Alternate Output	ALT	12	B	1
Week Programmer	Weekly Timer ^{*1}	WEEK	20 to 130		1
	Yearly Timer ^{*1}	YEAR	24 to 212		1
Interface	Message ^{*2}	MSG	12 or more		1
Pulse	Pulse Output	PULS	24		1
	Pulse Width Modulation	PWM	24		1
	Ramp Pulse Output	RAMP	28		1
	Zero Return	ZRN	20		1
	Advanced Ramp ^{*3}	ARAMP	36 to 240		1
Data Logging	Data Log ^{*4}	DLOG	24 to 276		1
	Data Trace ^{*4}	TRACE	24 to 276		1
Script	Script	SCRPT	12		1
Special	High-speed Counter	HSC	12	1	
	RS Flip-flop	RSFF	8	1	

- *1 The size of the WEEK/YEAR FB varies depending on the number of tabs.
- *2 The size of the MSG FB varies depending on the parameters used. The minimum size is 12 bytes.
- *3 The size of the ARAMP FB varies depending on the number of steps configured.
- *4 The size of the DLOG/TRACE FB varies depending on the logging parameters.

FBD Program Examples

Example program 1

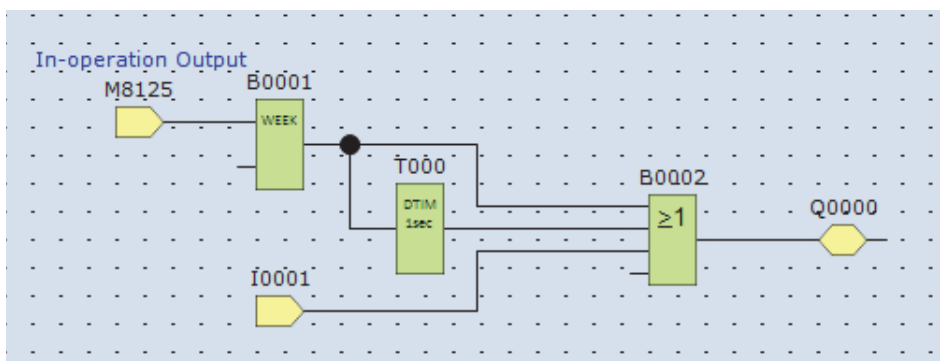

For example, in the above FBD program, the program size and the number of used devices can be calculated as described below.

Block number	FB		Size (Qty of Bytes)	Number of Used devices		
				Block (B)	Timer (T)	Counter (C)
M8125	SM	Special Internal Relay	Special internal relays, inputs, and outputs do not affect the FBD program size or the number of used devices.	1	0	0
I1	I	Input				
Q0	Q	Output				
B1	WEEK	Weekly Timer				
T0	DTIM	Dual Timer	12	0	3	0
B2	OR	Logical OR	12	1	0	0
Total			48 (Program size)	2	3	0

Example program 2

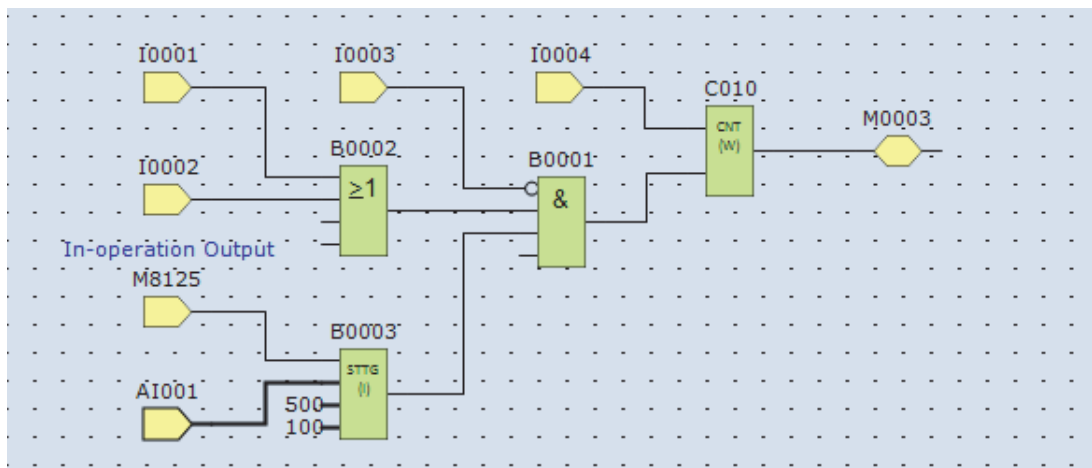

For example, in the above FBD program, the program size and the number of FBs can be calculated as described below.

Block number	FB		Size (Qty of Bytes)	Number of Used devices		
				Block (B)	Timer (T)	Counter (C)
I1	I	Input	Inputs, analog inputs, and internal relays do not affect the FBD program size or the number of used devices.			
I2	I	Input				
I3	I	Input				
I4	I	Input				
AI1	AI	Analog Input				
M0003	M	Internal Relay				
B1	AND	Logical AND	12	1	0	0
B2	OR	Logical OR	12	1	0	0
B3	STTG(I)	Schmitt Trigger	20	1	0	0
C10	CNT(W)	Adding Counter	12	0	0	1
Total			56 (Program size)	3	0	1

INDEX

- A**
 - Adding Counter (CNT) 9-1
 - Advanced Ramp (ARAMP) 15-26
 - Alternate Output (ALT) 12-1
 - Analog Input (AI) 5-4
- C**
 - Communication Adapter Information 3-11
 - CSV File 16-5
- D**
 - Data Comparison (CMP) 11-1
 - Data Log (DLOG) 16-1
 - Data Trace (TRACE) 16-8
 - Data types 4-10
 - Digital Input (I) 5-1
 - Digital Output (Q) 6-1
 - Download Program 1-12
 - Dual Timer (DTIM) 8-16
- E**
 - Exclusive Logical OR (XOR) 7-5
- F**
 - FB devices 4-9
- H**
 - Handling numeric values in floating point arithmetic operations 4-11
 - High-speed Counter (HSC) 18-1
 - Hour Meter (HOUR) 9-7
- I**
 - Internal Relay (M) 6-2
- L**
 - Logical AND (AND) 7-1
 - Logical OR (OR) 7-3
- M**
 - Message (MSG) 14-1
 - Monitor Function 1-14
 - Monitor Operation 1-14
- N**
 - Negation (NOT) 7-7
 - Negative Exclusive Logical OR (XNOR) 7-6
 - Negative Logical AND (NAND) 7-2
 - Negative Logical OR (NOR) 7-4
- O**
 - Off-delay Count Down Timer (TIMOD) 8-9
 - Off-delay Count Up Timer (TIMOU) 8-7
 - On/off-delay Timer (TIMCU) 8-11
 - On-delay Count Down Timer (TIMD) 8-5
 - On-delay Count Up Timer (TIMU) 8-1
 - Operation Basics 1-1
 - Convert Program 1-9
 - Download Program 1-12
 - Monitor Operation 1-14
 - PLC Selection 1-1
 - Quit WindLDR 1-15
 - Saving a Project 1-10
 - Simulation 1-11
 - Optional Cartridge Information 3-11
- P**
 - PLC Selection 1-1
 - Power Failure Memory Protection 8-4
 - Pulse Output (PULS) 15-1
 - Pulse Width Modulation (PWM) 15-6
- Q**
 - Quit WindLDR 1-15
- R**
 - Ramp Pulse Output (RAMP) 15-11
 - Random Pulse Output (RPULS) 8-19
 - Range Comparison (RCMP) 11-5
 - Reversible control enable 15-31
 - RS Flip-flop (RSFF) 18-3
- S**
 - Schmitt Trigger (STTG) 11-3
 - Script (SCRPT) 17-1
 - SD Memory Card Access Stop Flag 3-5
 - SD Memory Card Capacity 3-11
 - Shift Register (R) 5-3
 - Shift Register (SFR) 10-1
 - Shot Down (SOTD) 7-9
 - Shot Up (SOTU) 7-8
 - Simulation 1-11
 - Single Shot Pulse (SPULS) 8-14
 - Special Data Register 3-7
 - Special Internal Relay (SM) 5-2
 - Storage Method of 32-bit Data 4-10
- T**
 - Timer Accuracy 8-3
 - Truth Table (TRUTH) 7-10
- U**
 - Up/Down Selection Reversible Counter (CUD) 9-3
 - USB Connection 1-12
- W**
 - Weekly Timer (WEEK) 13-1
- Y**
 - Yearly Timer (YEAR) 13-13
- Z**
 - Zero Return (ZRN) 15-21

FB Index

- A** AI 5-4
ALT 12-1
AND 7-1
ARAMP 15-26
- C** CMP 11-1
CNT 9-1
CUD 9-3
- D** DLOG 16-1
DTIM 8-16
- H** HOUR 9-7
HSC 18-1
- I** I 5-1
- M** M 6-2
MSG 14-1
- N** NAND 7-2
NOR 7-4
NOT 7-7
- O** OR 7-3
- P** PULS 15-1
PWM 15-6
- Q** Q 6-1
- R** R 5-3
RAMP 15-11
RCMP 11-5
RPULS 8-19
RSFF 18-3
- S** SCRPT 17-1
SFR 10-1
SM 5-2
SOTD 7-9
SOTU 7-8
SPULS 8-14
STTG 11-3
- T** TIMCU 8-11
TIMD 8-5
TIMOD 8-9
TIMOU 8-7
TIMU 8-1
TRACE 16-8
TRUTH 7-10
- W** WEEK 13-1
- X** XNOR 7-6
XOR 7-5
- Y** YEAR 13-13
- Z** ZRN 15-21