

Interlock Switches with Solenoid

HS1L



3000N locking strength!

Suitable for large and heavy doors.



- See website for details on approvals and standards.

3000N locking strength

Suitable for large and heavy doors.

Six contacts in a compact housing (same size as HS1E)

Door open, closed, and locked statuses can be monitored for various applications.

Improved safety and usability!

- Manual unlock key allows for manual unlocking in the event of power failure or maintenance.
- Indicator has an independent circuit, and can be used for various purposes.
- Two locking mechanisms to choose from—spring lock (unlocked with energized solenoid) or solenoid lock (locked with energized solenoid).
- Wide operating temperature range (-20 to +55°C).

HS1L Interlock Switches with Solenoid

Ratings

Contact Ratings

Rated Insulation Voltage (Ui)		300V			
Rated Operating Current (Ith)		10A			
Rated Operating Voltage (Ue)		30V	125V	250V	
Rated Operating Current (Ie)	AC	Resistive Load (AC-12)	10A	10A	6A
		Inductive Load (AC-15)	10A	5A	3A
	DC	Resistive Load (DC-12)	8A	2.2A	1.1A
		Inductive Load (DC-13)	4A	1.1A	0.6A

- Minimum applicable load (reference value): 3V AC/DC, 5mA (Applicable range may vary with operating conditions and load types.)
- TÜV rating: AC-15 3A/250V, DC-13 4A/30V
UL, c-UL rating: A300
Pilot duty: AC 3A/250V
Pilot duty: DC 4A/30V
- CCC rating: AC 15 3A/250V, DC-13 4A/30V

Solenoid Unit and LED Indicator

Lock Mechanism		Spring Lock	Solenoid Lock
Solenoid	Rated Operating Voltage	24V DC (100% duty cycle)	
	Rated Current	200 mA (initial value)	
	Coil Resistance	120Ω (at 20°C)	
	Pickup Voltage	Rated voltage × 85% max. (at 20°C)	
	Dropout Voltage	Rated voltage × 10% max. (at 20°C)	
	Maximum Continuous Applicable Voltage	Rated voltage × 110%	
	Maximum Continuous Applicable Time	Continuous	
	Insulation Class	Class F	
LED	Rated Operating Voltage	24V DC	
	Rated Current	10 mA	
	Light Source	LED	
	Illumination Color	Green (G), Red (R)	

Specifications

Applicable Standard	ISO14119 IEC60947-5-1 EN60947-5-1 (TÜV approved) GS-ET-19 (TÜV approved) UL508 (UL listed) CSA C22.2 No. 14 (c-UL listed) GB14048.5 (CCC approved) IEC60204-1/EN60204-1 (applicable standards for use)
Operating Temperature	-20 to +55°C (no freezing)
Relative Humidity	45 to 85% (no condensation)
Storage Temperature	-40 to +80°C (no freezing)
Pollution Degree	3
Overvoltage Category	III
Impulse Withstand Voltage	4.0 kV (between LED, solenoid and ground: 1.5 kV)
Contact Resistance	50 mΩ maximum (initial value)
Insulation Resistance	Between live and dead metal parts: 100 MΩ minimum (500V DC megger) Between terminals of different poles: 100 MΩ minimum (500V DC megger)
Electric Shock Protection	Class II (IEC 61140)
Degree of Protection	IP67 (IEC 60529)
Shock Resistance	Damage limits: 1000 m/s ²
Vibration Resistance	Operating extremes: 10 to 55 Hz, amplitude 0.35 mm Damage limits: 30 Hz, amplitude 1.5 mm
Actuator Operating Speed	0.05 to 1.0 m/s
Direct Opening Travel	11 mm minimum
Direct Opening Force	50N minimum
Actuator Retention Force when Locked	3000N minimum (GS-ET-19) See E-058 for dimensions.
Operating Frequency	900 operations per hour
Mechanical Durability	1,000,000 operations minimum (GS-ET-19)
Electrical Durability	100,000 operations minimum (AC-15 3A/250V) 1,000,000 operations minimum (24V AC/DC, 100mA) (operating frequency 900 operations per hour)
Conditional Short-circuit Current	100A (250V) (Use 250V/10A fast acting type fuse for short-circuit protection.)
Weight (approx.)	450g (HS1L-DQ44)

Part No. Development

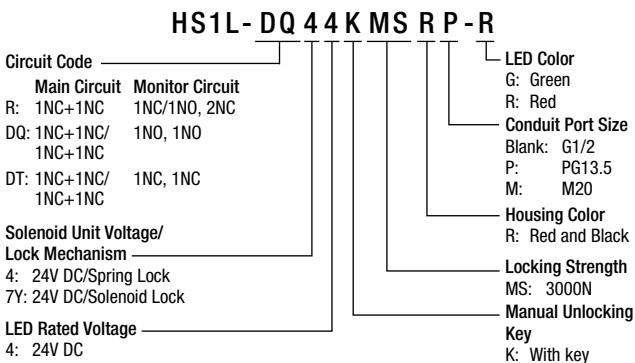

Terminal Numbers

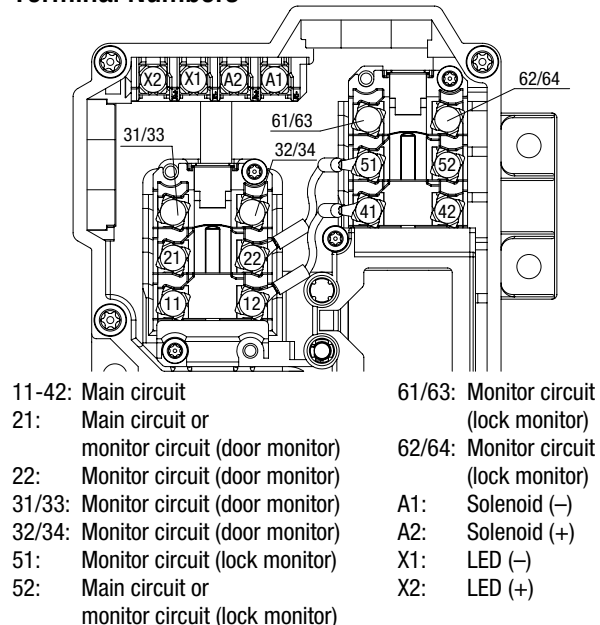

* There is no wiring between 22-51 with circuit code R.

APEM

Switches & Pilot Lights

Control Boxes

Emergency Stop Switches

Enabling Switches

Safety Products

Explosion Proof

Terminal Blocks

Relays & Sockets

Circuit Protectors

Power Supplies

LED Illumination

Controllers

Operator Interfaces

Sensors

AUTO-ID

Interlock Switches

Non-contact Interlock Switches

Safety Laser Scanners

Safety Light Curtains

Safety Modules

HS6B

HS6E

HS5D

HS5L

HS1L

Actuators for HS1/HS5/HS6

Actuators/ Padlock Hasp

HS1L Interlock Switches with Solenoid

Interlock Switch

Lock Mechanism	Circuit Code	Contact Configuration	Conduit Port Size	LED Indicator	Manual Unlocking Key	Part No.
Spring Lock	R	<p>Main: 1NC+1NC Door Monitor (Actuator Inserted) Lock Monitor (Solenoid OFF)</p> <p>Main circuit: 11-12, 21-22, 33-34, 41-42, 51-52, 61-62 Monitor circuit: 21-22, 33-34, 41-42, 51-52, 61-62</p>	G1/2	With	With	HS1L-R44KMSR-②
			PG13.5			HS1L-R44KMSRP-②
			M20			HS1L-R44KMSRM-②
	DQ	G1/2	HS1L-DQ44KMSR-②			
		PG13.5	HS1L-DQ44KMSRP-②			
		M20	HS1L-DQ44KMSRM-②			
	DT	G1/2	HS1L-DT44KMSR-②			
		PG13.5	HS1L-DT44KMSRP-②			
		M20	HS1L-DT44KMSRM-②			
Solenoid Lock	R	<p>Main: 1NC+1NC Door Monitor (Actuator Inserted) Lock Monitor (Solenoid ON)</p> <p>Main circuit: 11-12, 21-22, 33-34, 41-42, 51-52, 61-62 Monitor circuit: 21-22, 33-34, 41-42, 51-52, 61-62</p>	G1/2	With	With	HS1L-R7Y4KMSR-②
			PG13.5			HS1L-R7Y4KMSRP-②
			M20			HS1L-R7Y4KMSRM-②
	DQ	G1/2	HS1L-DQ7Y4KMSR-②			
		PG13.5	HS1L-DQ7Y4KMSRP-②			
		M20	HS1L-DQ7Y4KMSRM-②			
	DT	G1/2	HS1L-DT7Y4KMSR-②			
		PG13.5	HS1L-DT7Y4KMSRP-②			
		M20	HS1L-DT7Y4KMSRM-②			

- Specify an LED indicator color code in place of ② in the Part No. G: green, R: red
- The contact configuration shows the status when the actuator is inserted and the switch is locked.
- Actuators are not supplied with the interlock switch and must be ordered separately.

Actuator

Description	Part No.
Straight Actuator	HS9Z-A1S
L-shaped Actuator	HS9Z-A2S
Angle Adjustable (vertical) Actuator (for hinged door)	HS9Z-A3S

- Package quantity: 1

Accessories

Description	Part No.
Key Wrench for TORX Screw (L-shaped)	HS9Z-T1
Conduit Port Plug (Size: G1/2 only)	HS9Z-P1

- Package quantity: 1
- Key Wrench for TORX Screw is supplied with the interlock switch.

Dimensions and Mounting Hole Layouts

Interlock switch when using straight actuator (HS9Z-A1S)

Interlock switch when using L-shaped actuator (HS9Z-A2S)

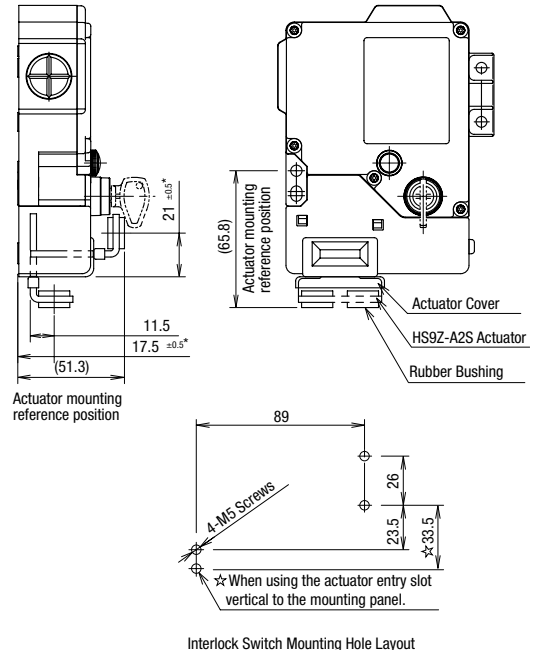
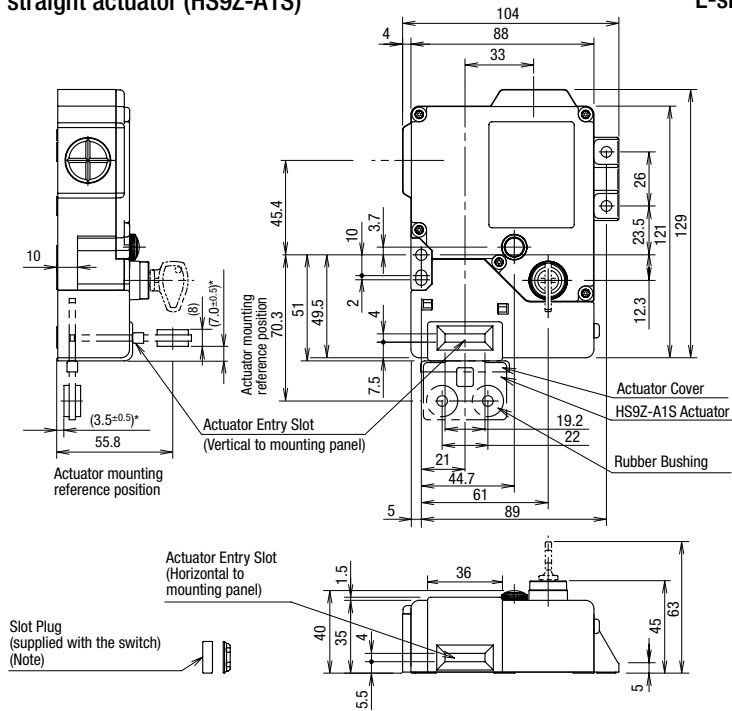

Note: Plug the unused actuator entry slot using the slot plug supplied with the interlock switch.

- Install the interlock switch using four mounting screws when using the actuator entry slot vertical to the mounting panel, and three mounting screws when using the actuator entry slot horizontal to the mounting panel.

- APEM
- Switches & Pilot Lights
- Control Boxes
- Emergency Stop Switches
- Enabling Switches
- Safety Products
- Explosion Proof
- Terminal Blocks
- Relays & Sockets
- Circuit Protectors
- Power Supplies
- LED Illumination
- Controllers
- Operator Interfaces
- Sensors
- AUTO-ID

- Interlock Switches
- Non-contact Interlock Switches
- Safety Laser Scanners
- Safety Light Curtains
- Safety Modules

- HS6B
- HS6E
- HS5D
- HS5L

- HS1L
- Actuators for HS1/HS5/HS6
- Actuators/ Padlock Hasp

HS1L Interlock Switches with Solenoid

Circuit Diagrams and Operating Characteristics

Spring Lock

		Status 1	Status 2	Status 3	Status 4	Manual Unlock
Interlock Switch Status		<ul style="list-style-type: none"> Door Closed Machine ready to operate Solenoid de-energized 	<ul style="list-style-type: none"> Door Closed Machine cannot be operated Solenoid energized 	<ul style="list-style-type: none"> Door Open Machine cannot be operated Solenoid energized 	<ul style="list-style-type: none"> Door Open Machine cannot be operated Solenoid de-energized 	<ul style="list-style-type: none"> Door Closed Machine cannot be operated Solenoid de-energized
Door Status						
Circuit Diagram (HS1L-DQ4)						
Door		Closed (locked)	Closed (unlocked)	Open	Open	Closed (unlocked)
Contact Configuration	HS1L-DQ4	Main Circuit 11-42				
		Main Circuit 21-52				
		Door Monitor Circuit (Door Open) 33-34				
		Lock Monitor Circuit (unlocked) 63-64				
Solenoid Power A1-A2		OFF (de-energized)	ON (energized)	ON (energized)	OFF (de-energized)	OFF (de-energized)

Solenoid Lock

		Status 1	Status 2	Status 3	Status 4	Manual Unlock
Interlock Switch Status		<ul style="list-style-type: none"> Door Closed Machine ready to operate Solenoid energized 	<ul style="list-style-type: none"> Door Closed Machine cannot be operated Solenoid de-energized 	<ul style="list-style-type: none"> Door Open Machine cannot be operated Solenoid de-energized 	<ul style="list-style-type: none"> Door Open Machine cannot be operated Solenoid energized 	<ul style="list-style-type: none"> Door Closed Machine cannot be operated Solenoid de-energized to energized
Door Status						
Circuit Diagram (HS1L-DQ7Y)						
Door		Closed (locked)	Closed (unlocked)	Open	Open	Closed (unlocked)
Contact Configuration	HS1L-DQ7Y	Main Circuit 11-42				
		Main Circuit 21-52				
		Door Monitor Circuit (Door Open) 33-34				
		Lock Monitor Circuit (unlocked) 63-64				
Solenoid Power A1-A2		ON (energized)	OFF (de-energized)	OFF (de-energized)	ON (energized) (*2)	OFF to ON (*1) (*2)

*1) Do not attempt manual unlocking while the solenoid is energized.

*2) Do not energize the solenoid for a long period of time while the door is open or while the door is unlocked manually.

Operation Characteristics (reference)

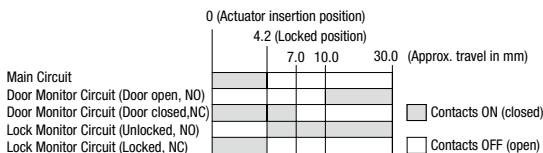

- The operation characteristics show the contact status when the actuator enters into the center of the entry slot.
- The circuit No. 12-41 and 22-51 are interconnected. Use circuits 11-42 and 21-52 for safety circuits (In HS1L-R model, circuit 12-41 is interconnected.)

APEM

Switches & Pilot Lights

Control Boxes

Emergency Stop Switches

Enabling Switches

Safety Products

Explosion Proof

Terminal Blocks

Relays & Sockets

Circuit Protectors

Power Supplies

LED Illumination

Controllers

Operator Interfaces

Sensors

AUTO-ID

Interlock Switches

Non-contact Interlock Switches

Safety Laser Scanners

Safety Light Curtains

Safety Modules

HS6B

HS6E

HS5D

HS5L

HS1L

Actuators for HS1/HS5/HS6

Actuators/ Padlock Hasp

Safety Precautions

- In order to avoid electric shock or fire, turn power off before installation, removal, wire connection, maintenance, or inspection of the interlock switch.
- If relays are used in the circuit between the interlock switch and the load, consider the danger and use safety relays, since welded or sticking contacts of standard relays may invalidate the functions of the interlock switch. Perform a risk assessment and establish a safety circuit which satisfies the requirement of the safety category.
- Do not place a PLC in the circuit between the interlock switch and the load. Safety security can be endangered in the event of a malfunction of the PLC.
- Do not disassemble or modify the interlock switch, otherwise a breakdown or an accident may occur.

- Do not install the actuator in a location where the human body may come in contact. Otherwise injury may occur.
- Install the actuator where it does not touch human body when the door is opened/closed. Otherwise injury may occur.
- Solenoid lock is locked when energized, and unlocked when de-energized. When energization is interrupted due to wire disconnection or other failures, the interlock switch may be unlocked causing possible danger to the operators. Solenoid lock must not be used in applications where locking is strictly required for safety. Perform a risk assessment and determine whether solenoid lock is appropriate.
- In order to prevent the interlock switch and actuator from being removed without authorization, it is recommended to install an one-way screw or a screw that needs a special tool for removal. Welding or rivet is also recommended.

Instructions

- Regardless of door types, do not use the interlock switch as a door stop. Install a mechanical door stop at the end of the door to protect the interlock switch against excessive force.
- Make sure that no force is applied on the actuator, otherwise the actuator may not be unlocked properly.
- Do not apply excessive shock to the interlock switch when opening or closing the door. A shock to the interlock switch exceeding 1,000 m/s² may cause damage to the interlock switch.
- If the operating atmosphere is contaminated, use a protective cover to prevent the entry of foreign objects into the interlock switch through the actuator entry slots. Entry of foreign objects into the interlock switch may affect the mechanism of the interlock switch and cause a breakdown.
- Plug the unused actuator entry slot using the slot plug supplied with the interlock switch.
- Do not store the interlock switches in a dusty, humid, or organic-gas atmosphere, or the switches are subject to direct sunlight.
- Use proprietary actuators only. When other actuators are used, the interlock switch may be damaged.
- Do not modify the actuator, otherwise it will damage the interlock switch.
- The actuator retention force is 3000N. Do not apply a load higher than the rated value. When a higher load is expected, provide an additional system consisting of other interlock switch without lock (such as the HS5D interlock switch) or a sensor to detect door opening and stop the machine.
- Regardless of door types, do not use the interlock switch as a door lock. Install a separate lock using a latch or other measures.
- While the solenoid is energized, the interlock switch temperature rises approximately 40°C above the ambient temperature (to approximately 95°C while the ambient temperature is 55°C). To prevent burns, do not touch. If cables come into contact with the interlock switch, use heat-resistant cables.
- Solenoid has polarity. Be sure of the correct polarity when wiring. Do not apply overvoltage, otherwise the solenoid will be burnt.

Minimum Radius of Hinged Door

When using the interlock switch for a hinged door, refer to the minimum radius of doors shown below. For the doors with small minimum radius, use angle adjustable actuators (HS9Z-A3S).

Note: The following values apply when the actuator does not interfere with the interlock switch when opening and closing the door. Because deviation or dislocation of hinged door may occur in actual applications, make sure of the correct operation before installation.

When using HS9Z-A2S Actuator

- When the door hinge is on the extension line of the interlock switch surface:

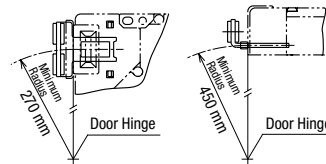

- When the door hinge is on the extension line of the actuator mounting surface:

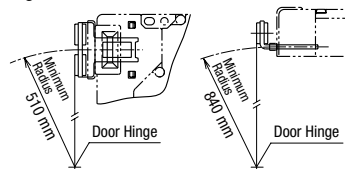

When using HS9Z-A3S Actuator

- When the door hinge is on the extension line of the interlock switch surface: 50 mm
- When the door hinge is on the extension line of the actuator mounting surface: 80 mm

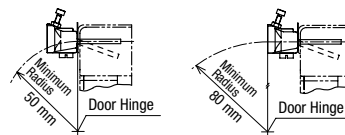

Actuator Angle Adjustment

- Using the angle adjustment screw, the actuator angle can be adjusted (refer to the dimensional drawing on page E-068). Adjustable angle: 0 to 20°
- The larger the adjusted angle of the actuator, the smaller the applicable radius of the door opening. After installing the actuator, open the door. Then adjust the actuator so that its edge can be inserted properly into the actuator entry slot of the interlock switch.
- After adjusting the actuator angle, apply Loctite to the adjustment screw so that the screw will not move.

Instructions

Mounting Examples

Install the interlock switch and actuator referring to the figures below.

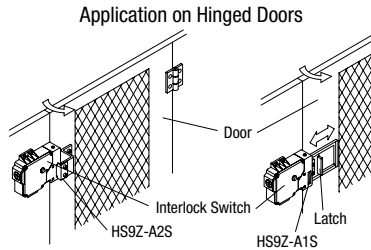
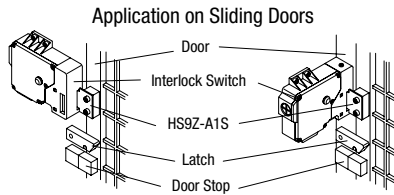

For Manual Unlocking

Spring lock

The HS1L allows manual unlocking of the actuator to pre-check proper door movement before wiring or turning power on, as well as for emergency use such as a power failure.

Solenoid lock

The solenoid lock interlock switch normally does not need the manual unlock. However, only when the interlock switch would not release the actuator even though the solenoid is de-energized, the interlock switch can be unlocked manually. Unlock the interlock switch manually only when the solenoid is de-energized. Do not unlock the interlock switch manually when the solenoid is energized.

Using manual unlock key

- When locking or unlocking the interlock switch manually, turn the key fully using the manual unlock key supplied with the interlock switch.
- Using the interlock switch with the key not fully turned (less than 90°) may cause damage to the interlock switch or operation failures. When manually unlocked, the interlock switch will keep the main circuit disconnected and the door unlocked. Main circuit and lock monitor circuit remain open.
- Do not leave the manual unlock key attached to the interlock switch during operation. This is dangerous and does not satisfy the requirement by safety standards, because the interlock switch can always be unlocked while the machine is in operation.

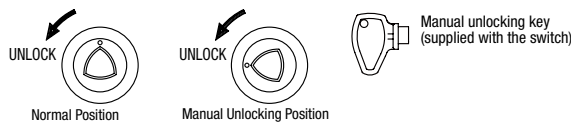

Unlocking from the back of interlock switch

Insert the tip of a small screwdriver into the oblong hole on the back of the interlock switch, and tilt toward the center of the switch until the actuator is unlocked.

Note: Provide a hole on the mounting panel for unlocking from the back.

When making a hole in the panel, take waterproof characteristics into consideration.

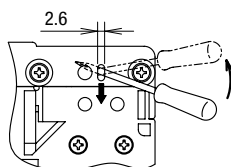

Safety Precautions

Before manually unlocking the interlock switch, make sure that the machine has come to a complete stop. Manual unlocking during operation may unlock the interlock switch before the machine stops, and the function of interlock switch with solenoid is lost.

On the solenoid lock, manual unlocking is provided for the situation where the switch cannot be unlocked even though the solenoid has turned off. Do not attempt manual unlocking while the solenoid is energized.

Precautions for Opening and Closing the Lid

- When opening the lid before wiring, make sure to open only the lid shown the following figure. Removing unnecessary screws may cause a failure of the interlock switch.
- Use HS9Z-T1 key wrench for TORX screw when removing and installing the lid.
- Make sure that no foreign objects such as dust, water, or oil enter the interlock switch when wiring.

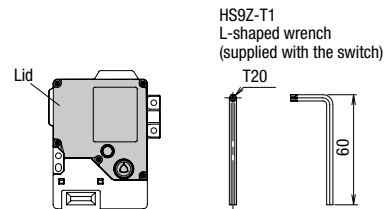

Applicable Crimping Terminal

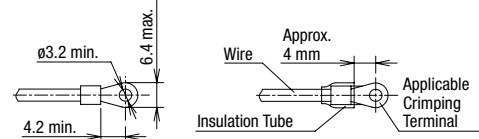

- Use an insulation tube on the crimping terminal.
- When using stranded wires, make sure that loose wires do not cause short circuit. Also, do not solder the terminal to prevent loose wires.

Applicable Crimping Terminal	Applicable Wire
N0.5-3 / FN0.5 (JST)	0.2 to 0.5 mm ²
N1.25-MS3 (JST)	0.25 to 1.65 mm ²
V1.25-YS3A (JST)	0.25 to 1.65 mm ²

Applicable Wire Size

- 0.5 to 1.5 mm²

- APEM
- Switches & Pilot Lights
- Control Boxes
- Emergency Stop Switches
- Enabling Switches
- Safety Products
- Explosion Proof
- Terminal Blocks
- Relays & Sockets
- Circuit Protectors
- Power Supplies
- LED Illumination
- Controllers
- Operator Interfaces
- Sensors
- AUTO-ID

- Interlock Switches
- Non-contact Interlock Switches
- Safety Laser Scanners
- Safety Light Curtains
- Safety Modules

- HS6B
- HS6E
- HS5D
- HS5L
- HS1L
- Actuators for HS1/HS5/HS6
- Actuators/ Padlock Hasp

Instructions

Applicable Cable Glands

Use IP67 cable glands.

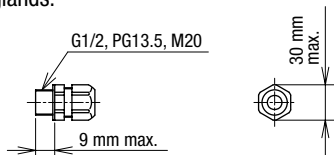

Refer to the instruction sheet from the URL below for recommended cable glands.

https://apac.idec.com/idec-apac/en/SGD/c/HS1L_Series

Conduit Port Opening

- Make an opening for wire connection by breaking one of the conduit-port knockouts on the interlock switch housing using a screwdriver.
- Before opening the conduit port, remove the locking ring for cable gland inside the interlock switch.
- When breaking the conduit port, take care not to damage the contact block or other parts inside the interlock switch. Also, take care not to damage the internal wiring. Cut wires cause operation failure.
- Cracks or burrs on the conduit entry may deteriorate protection against water.
- When changing to another conduit port, close the unused opening with an optional plug (Part No.: HS9Z-P1)

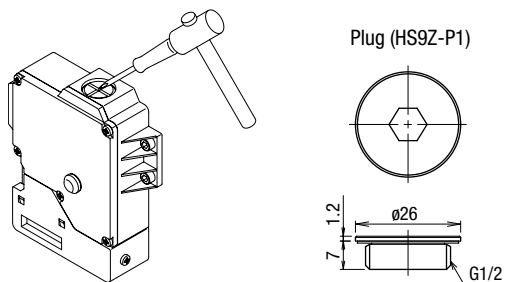

Recommended Tightening Torque

- HS1L interlock switch: 3.2 to 3.8 N·m (four M5 screws) (Note)
- Lid: 0.9 to 1.1 N·m (M4 screws)
- Terminal: 0.6 to 0.8 N·m (M3 screws)
- Cable gland: 2.7 to 3.3 N·m
- Actuators
 - HS9Z-A1S/A2S: 2.7 to 3.3 N·m (two M5 screws) (Note)
 - HS9Z-A3S: 4.5 to 5.5 N·m (two M6 screws) (Note)

Note: The above recommended tightening torque of the mounting screws are the values with hex socket head bolts. When other screws are used and tightened to a smaller torque, make sure that the screws do not become loose after mounting.

Wire Length Inside the Interlock Switch

	Screw Terminal No.	Through Conduit Port	
		①	②
Wire Length L1 (mm)	11	95 ± 2	45 ± 2
	21	85 ± 2	35 ± 2
	22	60 ± 2	70 ± 2
	31/33	75 ± 2	35 ± 2
	32/34	50 ± 2	60 ± 2
	42	65 ± 2	95 ± 2
	51	45 ± 2	70 ± 2
	52	55 ± 2	85 ± 2
	61/63	35 ± 2	60 ± 2
	62/64	45 ± 2	75 ± 2
	A1	50 ± 2	45 ± 2
	A2	60 ± 2	40 ± 2
	X1	70 ± 2	35 ± 2
X2	80 ± 2	35 ± 2	

Wire Stripping Length: L2 (mm) 7 ± 1

Wiring Example

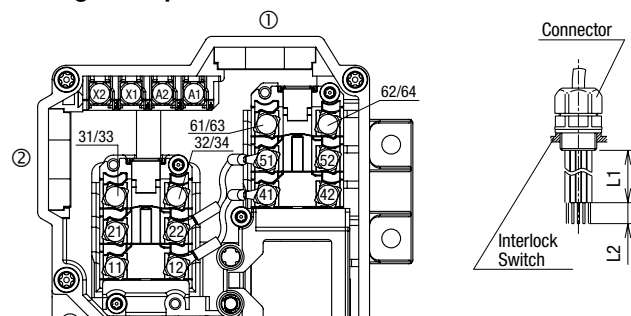

Note:

HS1L-R

Do not remove the wire between terminals 12-41, because these terminals are interconnected for safety circuit input. Use terminals 11-42 for safety circuit inputs. (GS-ET-19)

HS1L-DQ and HS1L-DT

Do not remove the wires between terminals 12-41 and 22-51, because these terminals are interconnected for safety circuit inputs. Use terminals 11-42 and 21-52 for safety circuit inputs. (GS-ET-19)

Ordering Terms and Conditions

Thank you for using IDEC Products.

By purchasing products listed in our catalogs, datasheets, and the like (hereinafter referred to as "Catalogs") you agree to be bound by these terms and conditions. Please read and agree to the terms and conditions before placing your order.

1. Notes on contents of Catalogs

- (1) Rated values, performance values, and specification values of IDEC products listed in this Catalog are values acquired under respective conditions in independent testing, and do not guarantee values gained in combined conditions.
Also, durability varies depending on the usage environment and usage conditions.
- (2) Reference data and reference values listed in Catalogs are for reference purposes only, and do not guarantee that the product will always operate appropriately in that range.
- (3) The specifications / appearance and accessories of IDEC products listed in Catalogs are subject to change or termination of sales without notice, for improvement or other reasons.
- (4) The content of Catalogs is subject to change without notice.

2. Note on applications

- (1) If using IDEC products in combination with other products, confirm the applicable laws / regulations and standards.
Also, confirm that IDEC products are compatible with your systems, machines, devices, and the like by using under the actual conditions. IDEC shall bear no liability whatsoever regarding the compatibility with IDEC products.
- (2) The usage examples and application examples listed in Catalogs are for reference purposes only. Therefore, when introducing a product, confirm the performance and safety of the instruments, devices, and the like before use. Furthermore, regarding these examples, IDEC does not grant license to use IDEC products to you, and IDEC offers no warranties regarding the ownership of intellectual property rights or non-infringement upon the intellectual property rights of third parties.
- (3) When using IDEC products, be cautious when implementing the following.
 - i. Use of IDEC products with sufficient allowance for rating and performance
 - ii. Safety design, including redundant design and malfunction prevention design that prevents other danger and damage even in the event that an IDEC product fails
 - iii. Wiring and installation that ensures the IDEC product used in your system, machine, device, or the like can perform and function according to its specifications
- (4) Continuing to use an IDEC product even after the performance has deteriorated can result in abnormal heat, smoke, fires, and the like due to insulation deterioration or the like. Perform periodic maintenance for IDEC products and the systems, machines, devices, and the like in which they are used.
- (5) IDEC products are developed and manufactured as general-purpose products for general industrial products. They are not intended for use in the following applications, and in the event that you use an IDEC product for these applications, unless otherwise agreed upon between you and IDEC, IDEC shall provide no guarantees whatsoever regarding IDEC products.
 - i. Use in applications that require a high degree of safety, including nuclear power control equipment, transportation equipment (railroads / airplanes / ships / vehicles / vehicle instruments, etc.), equipment for use in outer space, elevating equipment, medical instruments, safety devices, or any other equipment, instruments, or the like that could endanger life or human health
 - ii. Use in applications that require a high degree of reliability, such as provision systems for gas / waterworks / electricity, etc., systems that operate continuously for 24 hours, and settlement systems
 - iii. Use in applications where the product may be handled or used deviating from the specifications or conditions / environment listed in the Catalogs, such as equipment used outdoors or applications in environments subject to chemical pollution or electromagnetic interference
If you would like to use IDEC products in the above applications, be sure to consult with an IDEC sales representative.

3. Inspections

We ask that you implement inspections for IDEC products you purchase without delay, as well as thoroughly keep in mind management/maintenance regarding handling of the product before and during the inspection.

4. Warranty

- (1) Warranty period
The warranty period for IDEC products shall be one (1) year after purchase or delivery to the specified location. However, this shall not apply in cases where there is a different specification in the Catalogs or there is another agreement in place between you and IDEC.
- (2) Warranty scope
Should a failure occur in an IDEC product during the above warranty period for reasons attributable to IDEC, then IDEC shall replace or repair that product, free of charge, at the purchase location / delivery location of the product, or an IDEC service base. However, failures caused by the following reasons shall be deemed outside the scope of this warranty.
 - i. The product was handled or used deviating from the conditions / environment listed in the Catalogs
 - ii. The failure was caused by reasons other than an IDEC product
 - iii. Modification or repair was performed by a party other than IDEC
 - iv. The failure was caused by a software program of a party other than IDEC
 - v. The product was used outside of its original purpose
 - vi. Replacement of maintenance parts, installation of accessories, or the like was not performed properly in accordance with the user's manual and Catalogs
 - vii. The failure could not have been predicted with the scientific and technical standards at the time when the product was shipped from IDEC
 - viii. The failure was due to other causes not attributable to IDEC (including cases of force majeure such as natural disasters and other disasters)Furthermore, the warranty described here refers to a warranty on the IDEC product as a unit, and damages induced by the failure of an IDEC product are excluded from this warranty.

5. Limitation of liability

The warranty listed in this Agreement is the full and complete warranty for IDEC products, and IDEC shall bear no liability whatsoever regarding special damages, indirect damages, incidental damages, or passive damages that occurred due to an IDEC product.

6. Service scope

The prices of IDEC products do not include the cost of services, such as dispatching technicians. Therefore, separate fees are required in the following cases.

- (1) Instructions for installation / adjustment and accompaniment at test operation (including creating application software and testing operation, etc.)
- (2) Maintenance inspections, adjustments, and repairs
- (3) Technical instructions and technical training
- (4) Product tests or inspections specified by you

The above content assumes transactions and usage within your region. Please consult with an IDEC sales representative regarding transactions and usage outside of your region. Also, IDEC provides no guarantees whatsoever regarding IDEC products sold outside your region.

IDEC CORPORATION

Head Office 6-64, Nishi-Miyahara-2-Chome, Yodogawa-ku, Osaka 532-0004, Japan

USA IDEC Corporation
EMEA APEM SAS

Singapore IDEC Izumi Asia Pte. Ltd.
Thailand IDEC Asia (Thailand) Co., Ltd.
India IDEC Controls India Private Ltd.

China IDEC (Shanghai) Corporation
IDEC Izumi (H.K.) Co., Ltd.
Taiwan IDEC Taiwan Corporation

 www.idec.com

Japan IDEC Corporation

Specifications and other descriptions in this brochure are subject to change without notice.

2023 IDEC Corporation, All Rights Reserved.

