

S Series Sockets

SY / SM SH / SR





Various terminal styles available such as standard terminals, finger-safe types and Push-in types.







• See website for details on approvals and standards.

Front Wiring

Model	No. of Poles	Styles	Page
 SY	2, 4	Standard Slim cost-performance Finger-safe	H-058
 SU	2, 4	Push-in	H-058
 SM	2	Standard Slim cost-performance Finger-safe	H-058
 SH	1, 2, 3, 4	Standard Slim cost-performance Finger-safe	H-059
 SR	2, 3	Standard Finger-safe	H-059

Rear Wiring

Model	No. of Poles	Styles	Page
 SY	2, 4	Solder PC board	H-064
 SM	2	Solder PC board	H-064
 SH	1, 2, 3, 4	Solder PC board	H-065
 SR	2, 3	Solder Wire-warp	H-065

S Series Relay Sockets

Front Wiring Sockets

Package Quantity: 1

Mounting Style	Shape	No. of Poles	Style	Color	Part No. (Ordering Part No.)	Terminal Screw Applicable Wire	Recommended Tightening Torque	Approvals	Rated Insulation Voltage/ Rated Current	IEC Applicable Relays/Timers (example)
SY / SN		2	Standard	Black	SY2S-05B	M3 2mm ² max.	0.6 to 1.0N·m	UL, CSA, TUV	250V 7A	RY2S RY22S
		2	Finger-safe	Black	SY2S-05C	M3 2mm ² max.	0.6 to 1.0N·m	UL, CSA, TUV, CE	250V 7A	RY2S RY22S
		4	Standard	Black	SY4S-05B	M3 2mm ² max.	0.6 to 1.0N·m	UL, CSA, TUV	250V 7A	RY4S RY42S RU4S RU42S GT5Y-4
		4	Finger-safe	Black	SY4S-05C	M3 2mm ² max.	0.6 to 1.0N·m	UL, CSA, TUV, CE	250V 7A	RY4S RY42S RU4S RU42S GT5Y-4
		4	Standard	Black	SN4S-05D	M3 2.5mm ² max.	0.8N·m	UL, CSA, CE	300V 6A	RU4S RU42S RY4S RY42S GT5Y-4
		4	Finger-safe	Black	SY4S-05DF	M3 1.25 mm ² (2mm ² max.)	0.6 to 1.0N·m	UL, c-UL CE	250V 6A	RM2S RU2S GT5Y
SU		2	Push-in	Black	SU2S-21L	Solid wire / stranded wire 0.14 to 1.5mm ² , AWG26 to 16	—	c-UL, CE	300V AC/DC 12A	RU2S GT5Y-2
		4	Push-in	Black	SU4S-21L	Stranded wire with ferrule (without insulated cover) 0.5 to 1.5mm ² , AWG20 to 16 Stranded wire with ferrule (with insulated cover) 0.14 to 1.0mm ² , AWG26 to 18	—	c-UL, CE	300V AC/DC 8A	RU4S RU42S GT5Y-4
SM / SN		2	Standard	Black	SM2S-05B	M3 2mm ² max.	0.6 to 1.0N·m	UL, CSA, TUV	250V 7A	RM2S RU2S GT5Y-2
		2	Finger-safe	Black	SM2S-05C	M3 2mm ² max.	0.6 to 1.0N·m	UL, CSA, TUV, CE	250V 7A (UL, TÜV 10A)	
		2	Standard	Black	SN2S-05D	M3 2.5mm ² max.	0.8N·m	UL, CSA, CE	250V 10A	
		2	Finger-safe	Black	SM2S-05DF	M3 1.25 mm ² (2mm ² max.)	0.6 to 1.0N·m	UL, c-UL CE	250V 10A	

APEM

Switches & Pilot Lights

Control Boxes

Emergency Stop Switches

Enabling Switches

Safety Products

Explosion Proof

Terminal Blocks

Relays & Sockets

Circuit Protectors

Power Supplies

LED Illumination

Controllers

Operator Interfaces

Sensors

AUTO-ID

Relays

Sockets

DIN Rail Products

SJ

DF

SU

S

S Series Relay Sockets

Package Quantity: 1

Mounting Style	Shape	No. of Poles	Style	Color	Part No. (Ordering Part No.)	Terminal Screw Applicable Wire	Recommended Tightening Torque	Approvals	Rated Insulation Voltage/ Rated Current	IEDEC Applicable Relays/Timers (example)
SH		1	Standard	Black	SH1B-05B	M3.5 (coil terminal: M3) 2mm ² max.	1.0 to 1.3N·m (M3 screw: 0.6 to 1.0N·m)	UL, CSA, TUV	250V 10A (coil terminal 7A)	RH1B
		1	Finger-safe	Black	SH1B-05C	M3.5 (coil terminal: M3) 2mm ² max.	1.0 to 1.3N·m (M3 screw: 0.6 to 1.0N·m)	UL, CSA, TUV, CE	250V 10A (coil terminal 7A)	
		2	Standard	Black	SH2B-05B	M3.5 2mm ² max.	1.0 to 1.3N·m	UL, CSA, TUV	250V 10A	RH2B
		2	Finger-safe	Black	SH2B-05C	M3.5 2mm ² max.	1.0 to 1.3N·m	UL, CSA, TUV, CE	250V 10A	
		2	Slim, cost-performance	Black	SH2B-05D	M3.5 2mm ² max.	1.0 to 1.3N·m	UL, c-UL	250V 10A	
		3	Standard	Black	SH3B-05B	M3.5 2mm ² max.	1.0 to 1.3N·m	UL, CSA, TUV	250V 10A	RH3B
		3	Finger-safe	Black	SH3B-05C	M3.5 2mm ² max.	1.0 to 1.3N·m	UL, CSA, TUV, CE	250V 10A	
		4	Standard	Black	SH4B-05B	M3.5 2mm ² max.	1.0 to 1.3N·m	UL, CSA, TUV	250V 10A	RH4B
		4	Finger-safe	Black	SH4B-05C	M3.5 2mm ² max.	1.0 to 1.3N·m	UL, CSA, TUV, CE	250V 10A	
	SR (8 pin)		2	Standard	Black	SR2P-05B	M3.5 2mm ² max.	1.0 to 1.3N·m	UL, CSA, TUV	250V 10A
		2	Standard	Black	SR2P-06B	M3.5 2mm ² max.	1.0 to 1.3N·m	UL, CSA, TUV	250V 10A	RR2P GT3 (8 Pin) GT5P
		2	Finger-safe	Black	SR2P-05C	M3.5 2mm ² max.	1.0 to 1.3N·m	UL, CSA, TUV, CE	250V 10A	RR2P GT5P
SR (11 pin)		3	Standard	Black	SR3P-05B	M3.5 2mm ² max.	1.0 to 1.3N·m	UL, CSA, TUV	250V 10A	RR3P, RR3PA GT3 (11 Pin)
		3	Standard	Black	SR3P-06B	M3.5 2mm ² max.	1.0 to 1.3N·m	UL, CSA, TUV	250V 10A	RR3P, RR3PA GT3 (11 Pin)
		3	Finger-safe	Black	SR3P-05C	M3.5 2mm ² max.	1.0 to 1.3N·m	UL, CSA, TUV, CE	250V 10A	RR3P, RR3PA GT3 (11 Pin)

Package Quantity: 1

Mounting Style	Shape	No. of Poles	Style	Color	Part No. (Ordering Part No.)	Terminal Screw Applicable Wire	Recommended Tightening Torque	Approvals	Rated Insulation Voltage/ Rated Current	IEDEC Applicable Relays/Timers (example)
SJ		1	Standard	Black	SJ1S-05B	M3 2mm²max	0.6 to 1.0N·m	UL, CSA	250V 12A	RJ1S
				White	SJ1S-05BW					
		1	Finger-safe	Black	SJ1S-07L	M3 2mm²max	0.6 to 1.0N·m	UL, CSA, CE	250V 12A	
				White	SJ1S-07LW					
		1	Push-in	Black	SJ1S-21L	Solid wire / stranded wire 0.14 to 1.5mm², AWG26 to 16 Stranded wire with ferrule (with insulated cover) 0.5 to 1.5mm², AWG20 to 16 Stranded wire with ferrule (with insulated cover) 0.14 to 1.0mm², AWG26 to 18	-	c-UL, CE	300V AC/DC 12A	
		2	Standard	Black	SJ2S-05B	M3 2mm²max	0.6 to 1.0N·m	UL, CSA	250V 8A	
White				SJ2S-05BW						
	2	Finger-safe	Black	SJ2S-07L	M3 2mm²max	0.6 to 1.0N·m	UL, CSA, CE	250V 8A		
			White	SJ2S-07LW						
	2	Push-in	Black	SJ2S-21L	Solid wire / stranded wire 0.14 to 1.5mm², AWG26 to 16 Stranded wire with ferrule (with insulated cover) 0.5 to 1.5mm², AWG20 to 16 Stranded wire with ferrule (with insulated cover) 0.14 to 1.0mm², AWG26 to 18	-	c-UL, CE	300V AC/DC 8A		
SF1V		4	DIN rail mount	Black	SF1V-4-07L	0.7 to 1.65mm²	0.5 to 0.8N·m	UL, CSA, TUV, CE	250V 6A	RF1V-2A2B, RF1V-3A1B
		6	DIN rail mount	Black	SF1V-6-07L	0.7 to 1.65mm²	0.5 to 0.8N·m	UL, CSA, TUV, CE	250V 6A	RF1V-4A2B, RF1V-5A1B, RF1V-3A3B

• See SJ series pages of the catalog for SJ Series dimensions. • See E-189 for SF1V dimensions

- APEM
- Switches & Pilot Lights
- Control Boxes
- Emergency Stop Switches
- Enabling Switches
- Safety Products
- Explosion Proof
- Terminal Blocks
- Relays & Sockets
- Circuit Protectors
- Power Supplies
- LED Illumination
- Controllers
- Operator Interfaces
- Sensors
- AUTO-ID

Accessories

Applicable Hold-down Springs

Front Wiring Socket	IEDEC Applicable Relays/ Timers (example)	Leaf Spring (2 pcs)					
		SFA-202	SFA-101	SFA-203	SFA-502	SFA-503	SFA-511
SY2S-05B, SY2S-05C	RY2S, RY22S	○	○				
SY4S-05B SY4S-05C	RU4S, RU42S	○	○				
	RY4S, RY42S	○	○				
	GT5Y-4	○					
SN4S-05D SY4S-05DF	RU4S, RU42S				○		
	RY4S, RY42S				○		
	GT5Y-4						○
SM2S-05B SM2S-05C	RU2S	○	○				
	RM2S	○	○				
	GT5Y-2	○					
SN2S-05D SM2S-05DF	RU2S					○	
	RM2S				○		
	GT5Y-2						○
SU2S-11L	RU2S	○	○				
	RM2S	○	○				
	GT5Y-2	○					
SU4S-11L	RU4S, RU42S	○	○				
	RY4S, RY42S	○	○				
	GT5Y-4	○					
SH1B-05B, SH1B-05C	RH1B	○	○				
SH2B-05B, SH2B-05C	RH2B	○	○				
SH2B-05D	RH2B				○		
SH3B-05B, SH3B-05C	RH3B	○	○				
SH4B-05B, SH4B-05C	RH4B	○	○				
SR2P-05B, SR2P-05C	GT5P			○			
SR2P-06B	GT3 (8 pin)	○					
	GT5P	○					
SR3P-05B, SR3P-05C	GT3 (11 pin)			○			
SR3P-06B	GT3 (11 pin)	○					

- Relays
- Sockets
- DIN Rail Products
- SJ
- DF
- SU
- S

S Series Relay Sockets

Accessories

When ordering, specify the Ordering No.

Style	Shape	Part No.	Ordering No.	Package Quantity
Wire Spring		SFA-202	SFA-202PN20	20 (10 pairs)
		SFA-101	SFA-101PN20	20 (10 pairs)
		SFA-203	SFA-203PN20	20 (10 pairs)
		SFA-502	SFA-502PN20	For Relays 20 (10 pairs) Stainless
		SFA-503	SFA-503PN20	20 (10 pairs) Stainless
		SFA-511	SFA-511PN20	For Timer 20 (10 pairs) Stainless

• Two Leaf springs are used for one relay.

Dimensions

All dimensions in mm

(1) SY / SN

SY2S-05B

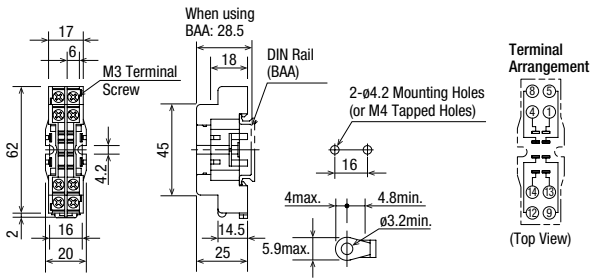

SY2S-05C

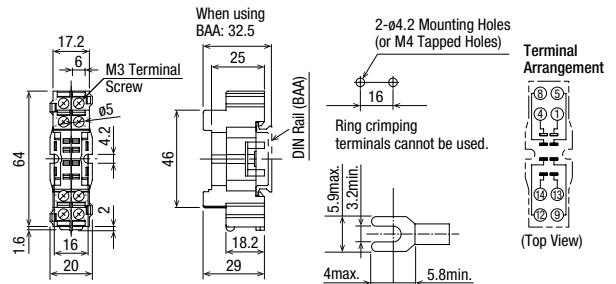

SY4S-05B

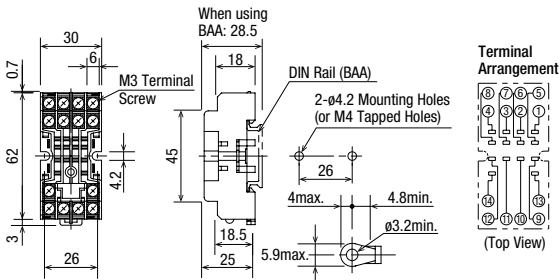

SY4S-05C

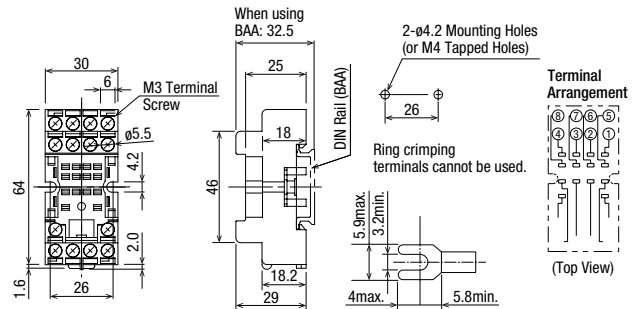

• See DF relay socket pages of the product catalog for SN4S-05D, SY4S-05DF dimensions.

Dimensions

All dimensions in mm

(2) SU
SU2S-21L

• For specifications, see SU series Push-in pages of the product catalog.

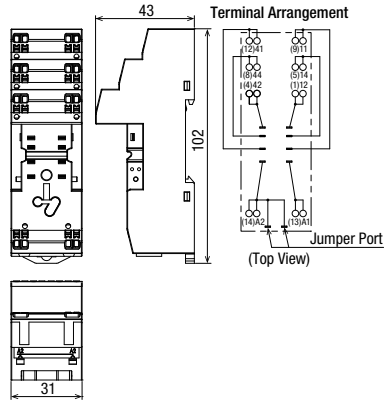

SU4S-21L

• For specifications, see SU series Push-in pages of the product catalog.

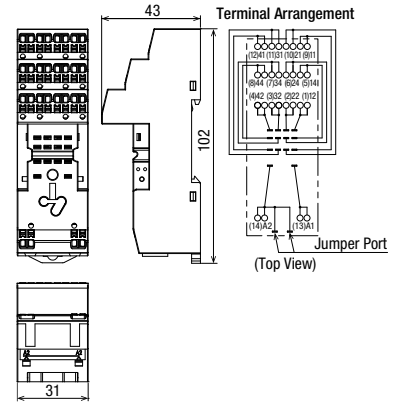

(3) SM / SN

SM2S-05B

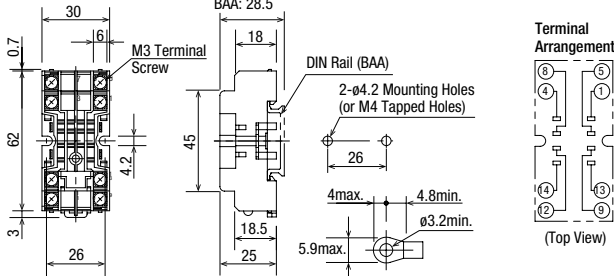

• See DF series pages of the product catalog for SM2S-05DF, SN2S-05D dimensions.

SM2S-05C

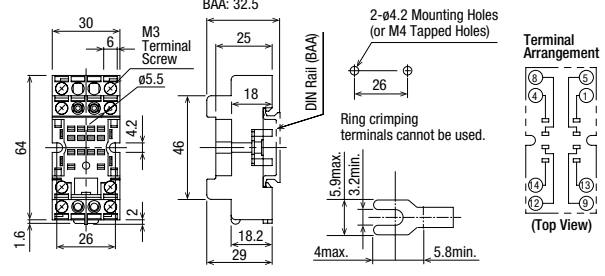

(4) SH

SH1B-05B

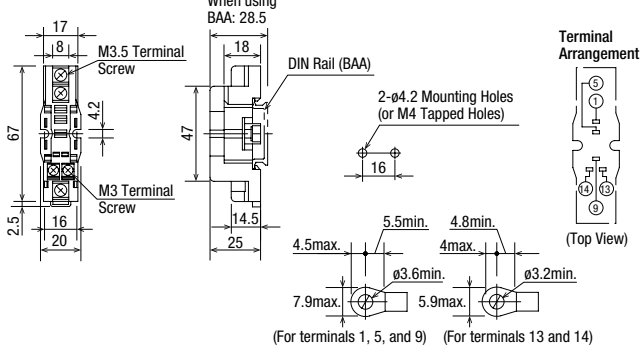

SH1B-05C

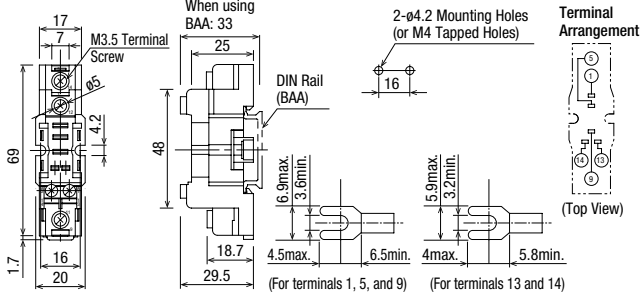

SH2B-05B

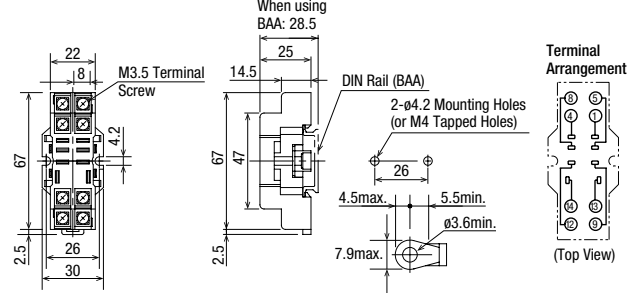

SH2B-05C

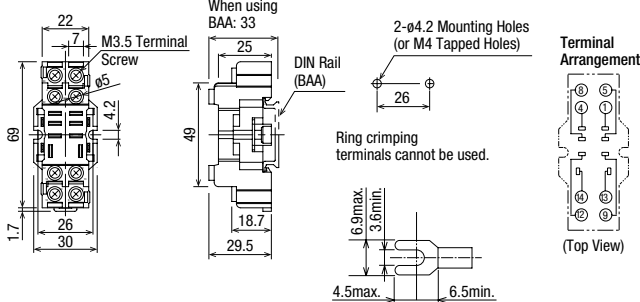

SH2B-05D

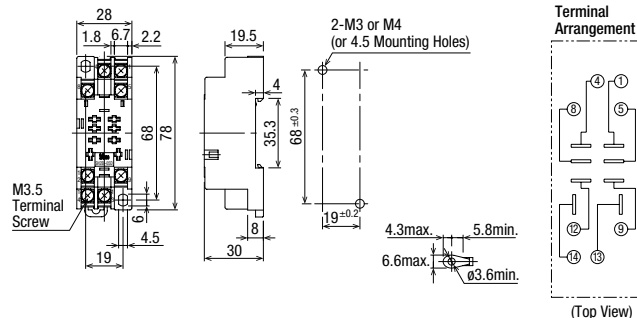

APEM

Switches & Pilot Lights

Control Boxes

Emergency Stop Switches

Enabling Switches

Safety Products

Explosion Proof

Terminal Blocks

Relays & Sockets

Circuit Protectors

Power Supplies

LED Illumination

Controllers

Operator Interfaces

Sensors

AUTO-ID

Relays

Sockets

DIN Rail Products

SJ

DF

SU

S

S Series Relay Sockets

Dimensions

All dimensions in mm

SH3B-05B

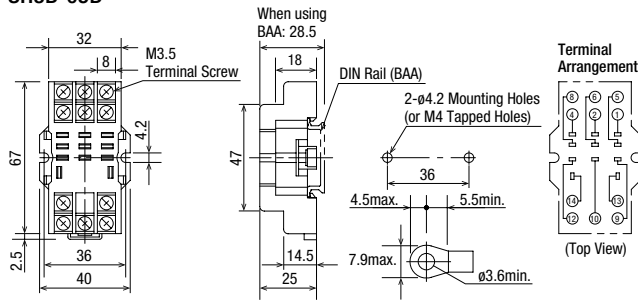

SH3B-05C

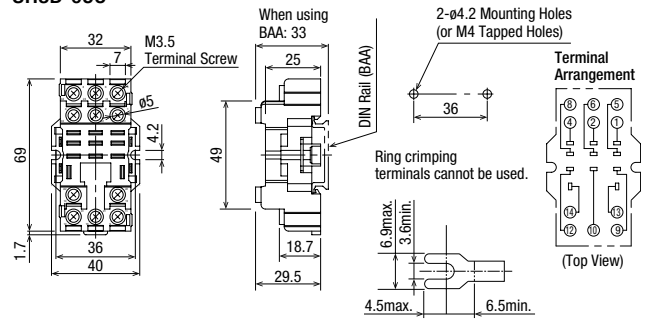

SH4B-05B

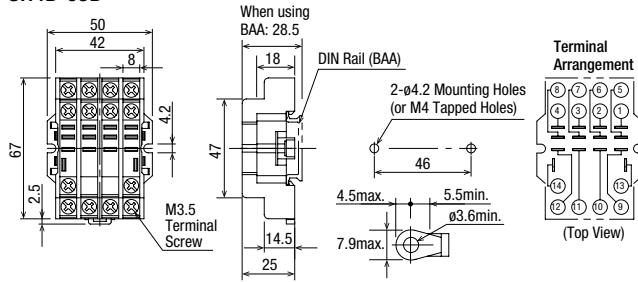

SH4B-05C

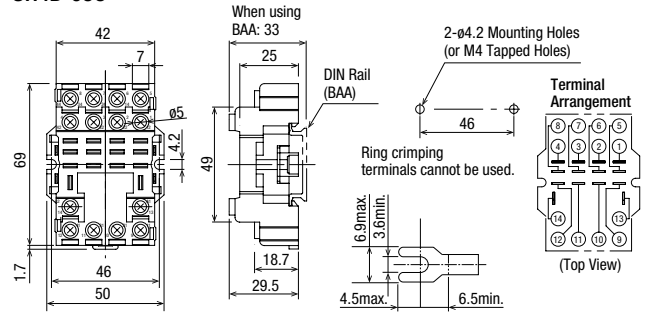

(5) SR

SR2P-05B

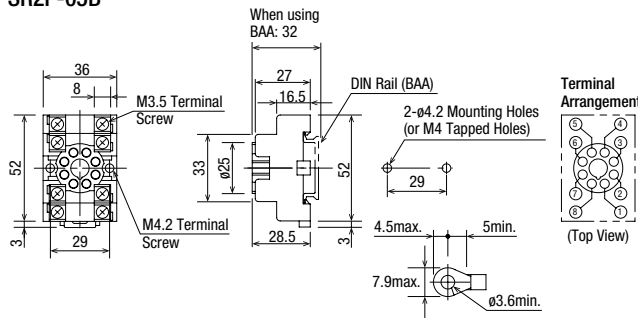

SR2P-06B

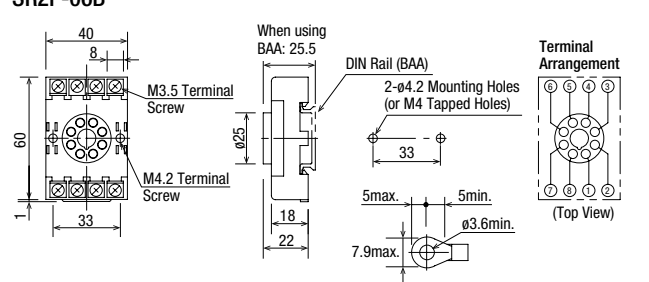

SR2P-05C

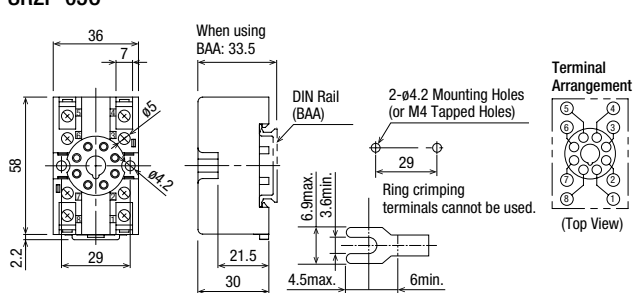

SR3P-05B

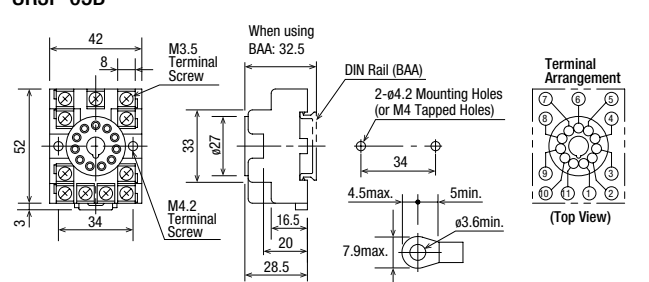

SR3P-06B

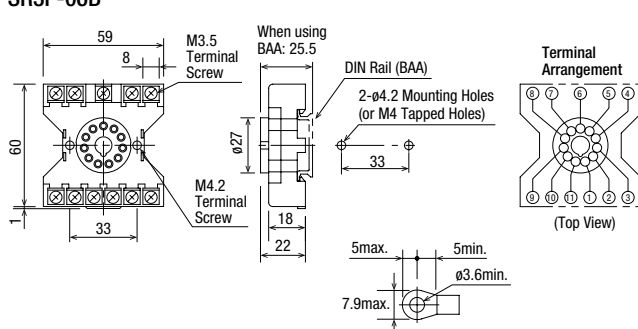



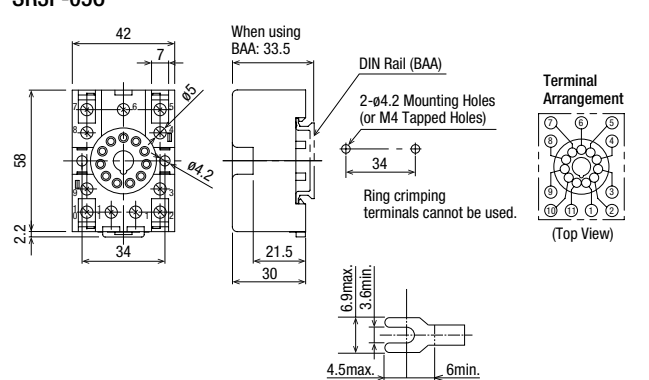



SR3P-05C



Rear Wiring Sockets

 Package Quantity: 1

Mounting Style	Shape	No. of Poles	Style	Color	Part No. (Ordering Part No.)	Approvals	Rated Insulation Voltage/ Rated Current	IEEC Applicable Relays/Timers (example)
SY		2	Solder Terminal	Black	SY2S-51	UL, CSA	250V 7A	RY2S RY22S
		2	PC Board Terminal	Black	SY2S-61	UL, CSA	250V 7A	
		4	Solder Terminal	Black	SY4S-51	UL, CSA	250V 7A (*1)	RY4S RY42S RU4S RU42S GT5Y
		4	PC Board Terminal	Black	SY4S-61	UL, CSA	250V 7A (*1)	
		4	PC Board Terminal	Black	SY4S-62	UL, CSA	250V 7A (*1)	
SM		2	Solder Terminal	Black	SM2S-51	UL, CSA	250V 10A	RM2S RU2S GT5Y-2
		2	PC Board Terminal	Black	SM2S-61	UL, CSA	250V 10A	
		2	PC Board Terminal	Black	SM2S-62	UL, CSA	250V 10A	RM2S RU2S
SF1V		4	PC Board Terminal	Black	SF1V-4-61	UL, CSA, TUV, CE	250V 6A	RF1V-2A2B RF1V-3A1B
		6	PC Board Terminal	Black	SF1V-6-61	UL, CSA, TUV, CE	250V 6A	RF1V-4A2B RF1V-5A1B RF1V-3A3B

*1) When using 2 poles and 4-pole sockets together, the UL rated current is 10A.

- See SF1V relay socket pages of the Product Catalog ([E-189](#)) for dimensions.

APEM

Switches & Pilot Lights

Control Boxes

Emergency Stop Switches

Enabling Switches

Safety Products

Explosion Proof

Terminal Blocks

Relays & Sockets

Circuit Protectors

Power Supplies

LED Illumination

Controllers

Operator Interfaces

Sensors

AUTO-ID

Relays

Sockets

DIN Rail Products

SJ















DF

SU

S

S Series Relay Sockets

Package Quantity: 1

Mounting Style	Shape	No. of Poles	Style	Color	Part No. (Ordering Part No.)	Approvals	Rated Insulation Voltage/ Rated Current	IEEC Applicable Relays/Timers (example)
SH		1	Solder Terminal	Black	SH1B-51	UL, CSA	250V 10A (coil terminal 7A)	RH1B
		1	PC Board Terminal	Black	SH1B-62	UL, CSA	250V 10A coil terminal 7A)	
		2	Solder Terminal	Black	SH2B-51	UL, CSA	250V 10A	RH2B
		2	PC Board Terminal	Black	SH2B-62	UL, CSA	250V 10A	
		3	Solder Terminal	Black	SH3B-51	UL, CSA	250V 10A	RH3B
		3	PC Board Terminal	Black	SH3B-62	UL, CSA	250V 10A	
		4	Solder Terminal	Black	SH4B-51	UL, CSA	250V 10A	RH4B
		4	PC Board Terminal	Black	SH4B-62	UL, CSA	250V 10A	
SR (8 pin)		2	Solder Terminal	Black	SR2P-511	UL, CSA	250V 10A	RR2P GT5P
		2	Solder Terminal	Black	SR6P-S08	—	250V 10A	RR2P GT3 (8 pin)
		2	Rear Wiring Screw Terminal	Black	SR6P-M08G	—	250V 10A	RR2P GT3 (8 pin)
SR (11 pin)		3	Solder Terminal	Black	SR3P-511	UL, CSA	250V 10A	RR3P, RR3PA GT3 (11 pin)
		3	Solder Terminal	Black	SR6P-S11	—	250V 10A	GT3 (11 pin)
		3	Rear Wiring Screw Terminal	Black	SR6P-M11G	—	250V 5A	RR3P, RR3PA GT3 (11 pin)

APEM

Switches & Pilot Lights

Control Boxes

Emergency Stop Switches

Enabling Switches

Safety Products

Explosion Proof

Terminal Blocks

Relays & Sockets

Circuit Protectors

Power Supplies

LED Illumination

Controllers

Operator Interfaces

Sensors

AUTO-ID

Relays

Sockets

DIN Rail Products

SJ

DF

SU

S

Accessories

Sockets and Applicable Hold-down Springs

Front Wiring Socket	IDEC Applicable Relays/ Timers (example)	Wire Spring	Leaf Spring (2 pcs)		Leaf Spring	
		SY4S-51F1	SFA-302	SFA-301	SFA-402	SFA-504
SY2S-51 SY2S-61	RY2S, RY22S	○	○	○		
SY4S-51 SY4S-61	RU4S, RU42S	○	○	○		
	RY4S, RY42S	○	○	○		
	GT5Y-4		○			
SY4S-62	RU4S, RU42S	○				○
	RY4S, RY42S	○				○
SM2S-51 SM2S-61	RM2S	○	○	○		
	RU2S	○	○	○		
	GT5Y-2		○			
SM2S-62	RM2S	○				○
	RU2S	○				○
SH1B-51 SH1B-62	RH1B	○	○	○		
SH2B-51	RH2B	○	○	○		
SH2B-62	RH2B	○				○
SH3B-51 SH3B-62	RH3B	○	○	○		
SH4B-51 SH4B-62	RH4B	○ (2pcs)	○	○		
SR2P-511 (8 pin) SR3P-511 (11 pin)	GT3 (8 pin) GT3 (11 pin)				○	

- For close mounting of rear mount sockets, use wire springs or SFA-302 leaf springs.

Hold-down Springs

When ordering, specify the Ordering No.

Style	Shape	Part No.	Ordering No.	Package Quantity
Wire Springs		SY4S-51F1	SY4S-51F1PN10	10
Leaf Springs		SFA-302	SFA-302PN20	20 (10 pairs)
		SFA-301	SFA-301PN20	20 (10 pairs)
		SFA-402	SFA-402PN10	10
		SFA-504	SFA-504PN10	10

- Two Leaf springs are used for one relay. (One leaf spring is used for SFA-402 and SFA-504)

S Series Relay Sockets

Dimensions

All dimensions in mm

(1) SY

SY2S-51 (Solder Terminal)

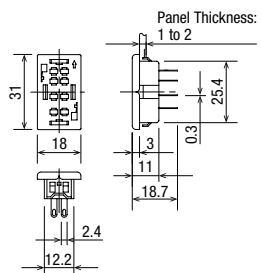

Terminal Arrangement

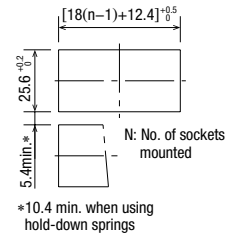
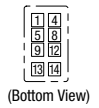

SY2S-61 (PC Board Terminal)

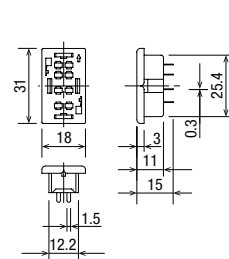

Terminal Arrangement

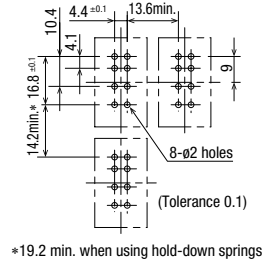
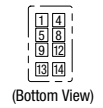

SY4S-51 (Solder Terminal)

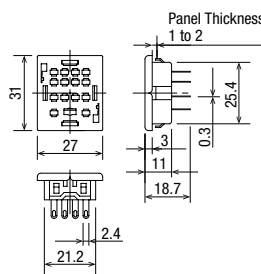

Terminal Arrangement

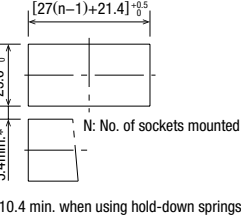
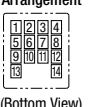

SY4S-61 (PC Board Terminal)

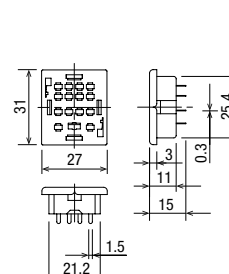

Terminal Arrangement

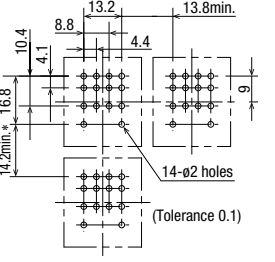
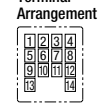

SY4S-62 (PC Board Terminal)

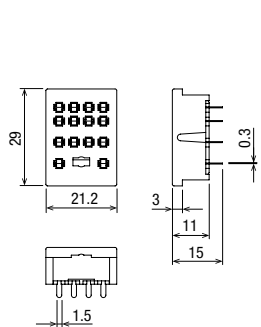

Terminal Arrangement

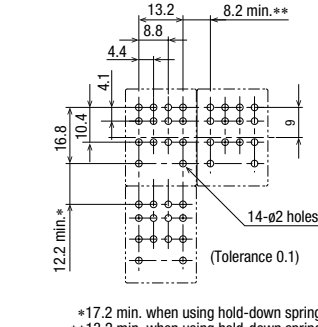
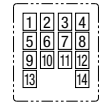

(2) SM

SM2S-51 (Solder Terminal)

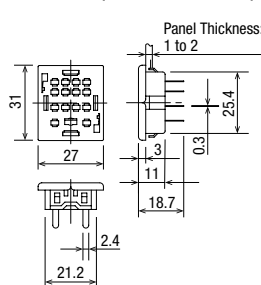

Terminal Arrangement

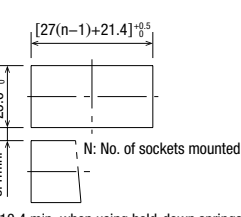
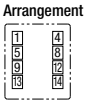

SM2S-61 (PC Board Terminal)

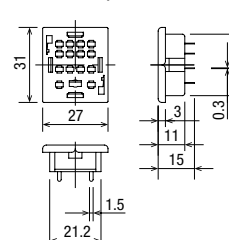

Terminal Arrangement

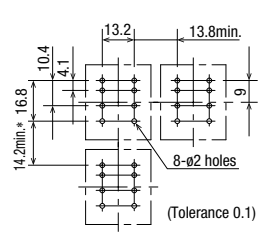
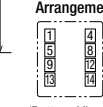

SM2S-62 (PC Board Terminal)

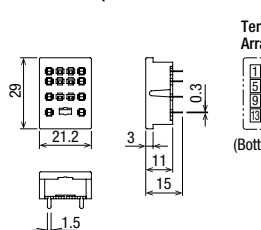

Terminal Arrangement

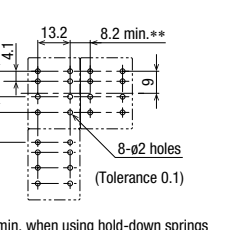
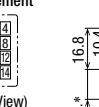

APEM
Switches & Pilot Lights
Control Boxes
Emergency Stop Switches
Enabling Switches
Safety Products
Explosion Proof
Terminal Blocks
Relays & Sockets
Circuit Protectors
Power Supplies
LED Illumination
Controllers
Operator Interfaces
Sensors
AUTO-ID
Relays
Sockets
DIN Rail Products

SJ
DF
SU
S

Dimensions

(3) SH

SH1B-51 (Solder Terminal)

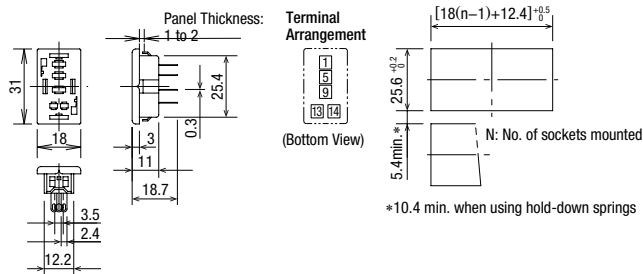

SH1B-62 (PC Board Terminal)

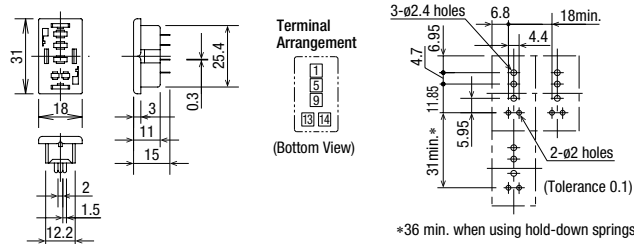

SH2B-51 (Solder Terminal)

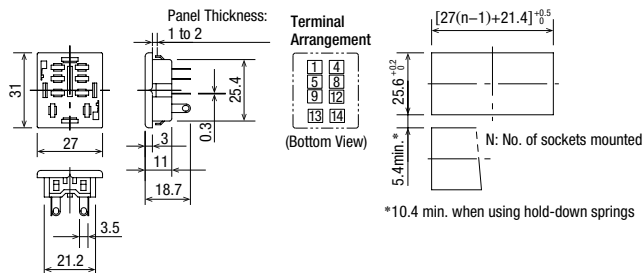

SH2B-62 (PC Board Terminal)

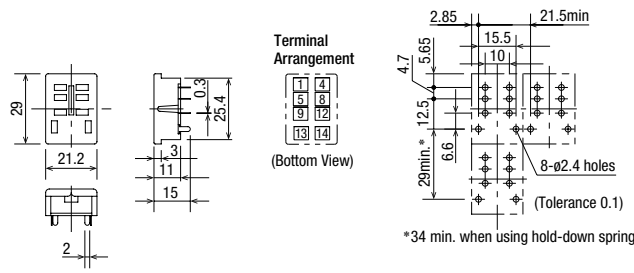

SH3B-51 (Solder Terminal)

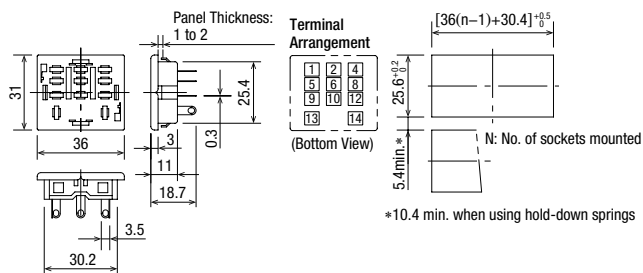

SH3B-62 (PC Board Terminal)

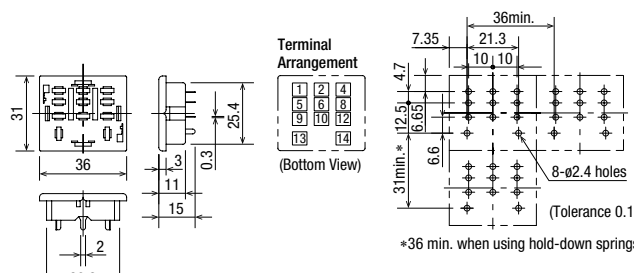

SH4B-51 (Solder Terminal)

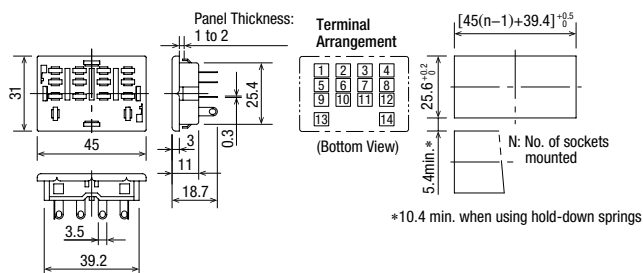

SH4B-62 (PC Board Terminal)

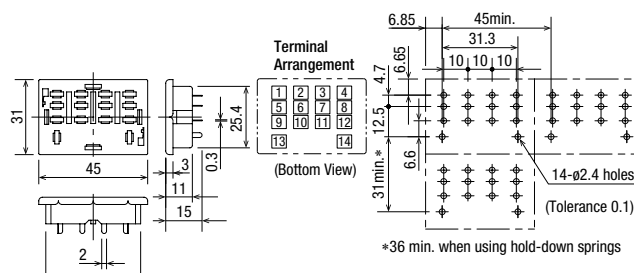

(4) SR

SR2P-511 (Solder Terminal)

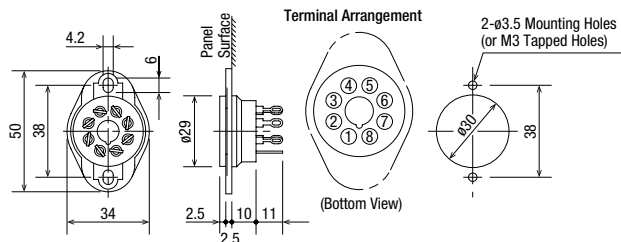

SR3P-511 (Solder Terminal)

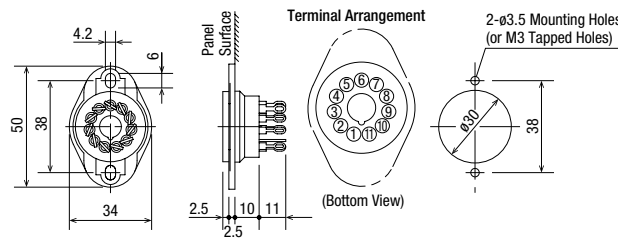

• See GT3 timer pages of the Product Catalog for SR6P-S08, SR6P-M08G dimensions.

• See GT3 timer pages of the Product Catalog for SR6P-S11, SR6P-M11G dimensions.

S Series Relay Sockets

Accessories

When ordering, specify the Ordering No.

Name	Shape	Specifications	Part No.	Ordering No.	Package Quantity	Remarks
DIN Rail		Aluminum Weight: Approx. 200g	BAA1000	BAA1000PN10	10	See H-071 for DIN rail products
End Clip (*1)		Zinc-plated steel Weight: Approx. 15g	BNL5	BNL5PN10	10	See H-071 for DIN rail products
			BNL6	BNL6PN10	10	
DIN Rail Spacer (*2)		Plastic (black)	SA-406B	SA-406B	1	Thickness: 5 mm Used for adjusting spacing between sockets mounted on a DIN rail

*1) When mounting the end clip (BNL5 or BNL6) on to a DIN rail, make sure that it is positioned first so that socket does not deform in shape.
 *2) By using the spacer (No. SA-406B) to a DIN rail, the spacing between sockets can be adjusted in 5mm increments.

Installation of End Clip and DIN Rail Spacer

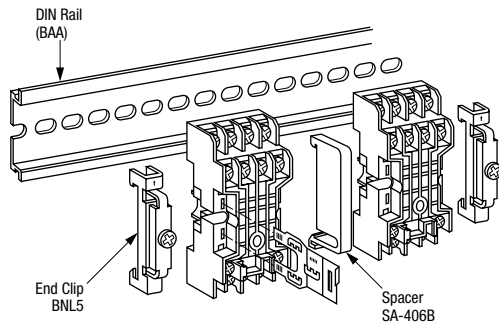

Application Example of End Clip and DIN Rail Spacer

Use DIN rail spacers for adding space between adjoining sockets to prevent miswiring and identify wiring groups.

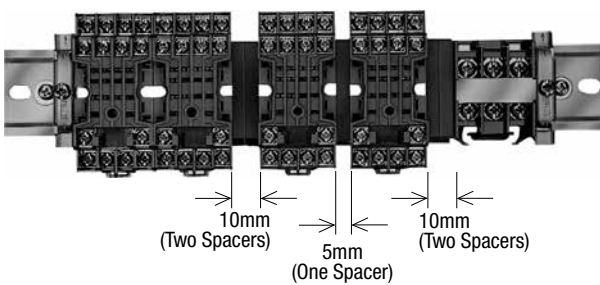

Instructions

Collective Mounting of Panel Mount Sockets

The SY, SM, and SH series panel mount sockets are designed to mount in panel cut-outs collectively. These sockets can be mounted in the same panel cut-out due to the standardized size.

Mounting into Panel Cut-out

To mount, insert the sockets with mounting springs facing top and bottom edges of the panel cut-out. Push the mounting spring using a screwdriver until the mounting spring clicks into the panel.

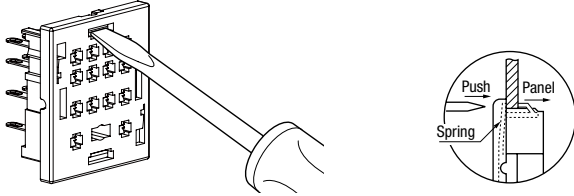

Soldering

When soldering, use a soldering iron of 60W (350°C), and quickly complete soldering within approximately 3 seconds. Sn-Ag-Cu is recommended for lead-free soldering. Ensure to keep the solder away from the socket as much as possible. Do not apply external force by bending the terminal or pulling the wire.

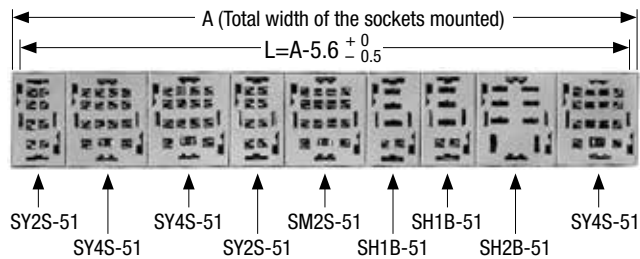

$$L = \frac{A}{18 + 27 + 27 + 18 + 27 + 18 + 18 + 27 + 27} - 5.6 = 201.4 \begin{matrix} +0 \\ -0.5 \end{matrix}$$

Socket Width

Socket	Width
SY2S-51	18mm
SY4S-51	27mm
SM2S-51	
SH1B-51	18mm
SH2B-51	27mm
SH3B-51	36mm
SH4B-51	45mm

APEM

Switches & Pilot Lights

Control Boxes

Emergency Stop Switches

Enabling Switches

Safety Products

Explosion Proof

Terminal Blocks

Relays & Sockets

Circuit Protectors

Power Supplies

LED Illumination

Controllers

Operator Interfaces

Sensors

AUTO-ID

Relays

Sockets

DIN Rail Products

SJ

DF

SU

S

Ordering Terms and Conditions

Thank you for using IDEC Products.

By purchasing products listed in our catalogs, datasheets, and the like (hereinafter referred to as "Catalogs") you agree to be bound by these terms and conditions. Please read and agree to the terms and conditions before placing your order.

1. Notes on contents of Catalogs

- (1) Rated values, performance values, and specification values of IDEC products listed in this Catalog are values acquired under respective conditions in independent testing, and do not guarantee values gained in combined conditions.
Also, durability varies depending on the usage environment and usage conditions.
- (2) Reference data and reference values listed in Catalogs are for reference purposes only, and do not guarantee that the product will always operate appropriately in that range.
- (3) The specifications / appearance and accessories of IDEC products listed in Catalogs are subject to change or termination of sales without notice, for improvement or other reasons.
- (4) The content of Catalogs is subject to change without notice.

2. Note on applications

- (1) If using IDEC products in combination with other products, confirm the applicable laws / regulations and standards.
Also, confirm that IDEC products are compatible with your systems, machines, devices, and the like by using under the actual conditions. IDEC shall bear no liability whatsoever regarding the compatibility with IDEC products.
- (2) The usage examples and application examples listed in Catalogs are for reference purposes only. Therefore, when introducing a product, confirm the performance and safety of the instruments, devices, and the like before use. Furthermore, regarding these examples, IDEC does not grant license to use IDEC products to you, and IDEC offers no warranties regarding the ownership of intellectual property rights or non-infringement upon the intellectual property rights of third parties.
- (3) When using IDEC products, be cautious when implementing the following.
 - i. Use of IDEC products with sufficient allowance for rating and performance
 - ii. Safety design, including redundant design and malfunction prevention design that prevents other danger and damage even in the event that an IDEC product fails
 - iii. Wiring and installation that ensures the IDEC product used in your system, machine, device, or the like can perform and function according to its specifications
- (4) Continuing to use an IDEC product even after the performance has deteriorated can result in abnormal heat, smoke, fires, and the like due to insulation deterioration or the like. Perform periodic maintenance for IDEC products and the systems, machines, devices, and the like in which they are used.
- (5) IDEC products are developed and manufactured as general-purpose products for general industrial products. They are not intended for use in the following applications, and in the event that you use an IDEC product for these applications, unless otherwise agreed upon between you and IDEC, IDEC shall provide no guarantees whatsoever regarding IDEC products.
 - i. Use in applications that require a high degree of safety, including nuclear power control equipment, transportation equipment (railroads / airplanes / ships / vehicles / vehicle instruments, etc.), equipment for use in outer space, elevating equipment, medical instruments, safety devices, or any other equipment, instruments, or the like that could endanger life or human health
 - ii. Use in applications that require a high degree of reliability, such as provision systems for gas / waterworks / electricity, etc., systems that operate continuously for 24 hours, and settlement systems
 - iii. Use in applications where the product may be handled or used deviating from the specifications or conditions / environment listed in the Catalogs, such as equipment used outdoors or applications in environments subject to chemical pollution or electromagnetic interference
If you would like to use IDEC products in the above applications, be sure to consult with an IDEC sales representative.

3. Inspections

We ask that you implement inspections for IDEC products you purchase without delay, as well as thoroughly keep in mind management/maintenance regarding handling of the product before and during the inspection.

4. Warranty

- (1) Warranty period
The warranty period for IDEC products shall be one (1) year after purchase or delivery to the specified location. However, this shall not apply in cases where there is a different specification in the Catalogs or there is another agreement in place between you and IDEC.
- (2) Warranty scope
Should a failure occur in an IDEC product during the above warranty period for reasons attributable to IDEC, then IDEC shall replace or repair that product, free of charge, at the purchase location / delivery location of the product, or an IDEC service base. However, failures caused by the following reasons shall be deemed outside the scope of this warranty.
 - i. The product was handled or used deviating from the conditions / environment listed in the Catalogs
 - ii. The failure was caused by reasons other than an IDEC product
 - iii. Modification or repair was performed by a party other than IDEC
 - iv. The failure was caused by a software program of a party other than IDEC
 - v. The product was used outside of its original purpose
 - vi. Replacement of maintenance parts, installation of accessories, or the like was not performed properly in accordance with the user's manual and Catalogs
 - vii. The failure could not have been predicted with the scientific and technical standards at the time when the product was shipped from IDEC
 - viii. The failure was due to other causes not attributable to IDEC (including cases of force majeure such as natural disasters and other disasters)Furthermore, the warranty described here refers to a warranty on the IDEC product as a unit, and damages induced by the failure of an IDEC product are excluded from this warranty.

5. Limitation of liability

The warranty listed in this Agreement is the full and complete warranty for IDEC products, and IDEC shall bear no liability whatsoever regarding special damages, indirect damages, incidental damages, or passive damages that occurred due to an IDEC product.

6. Service scope

The prices of IDEC products do not include the cost of services, such as dispatching technicians. Therefore, separate fees are required in the following cases.

- (1) Instructions for installation / adjustment and accompaniment at test operation (including creating application software and testing operation, etc.)
- (2) Maintenance inspections, adjustments, and repairs
- (3) Technical instructions and technical training
- (4) Product tests or inspections specified by you

The above content assumes transactions and usage within your region. Please consult with an IDEC sales representative regarding transactions and usage outside of your region. Also, IDEC provides no guarantees whatsoever regarding IDEC products sold outside your region.

IDEC CORPORATION

Head Office 6-64, Nishi-Miyahara-2-Chome, Yodogawa-ku, Osaka 532-0004, Japan

USA IDEC Corporation
EMEA APEM SAS

Singapore IDEC Izumi Asia Pte. Ltd.
Thailand IDEC Asia (Thailand) Co., Ltd.
India IDEC Controls India Private Ltd.

China IDEC (Shanghai) Corporation
IDEC Izumi (H.K.) Co., Ltd.
Taiwan IDEC Taiwan Corporation

 www.idec.com

Japan IDEC Corporation

Specifications and other descriptions in this brochure are subject to change without notice.

2023 IDEC Corporation, All Rights Reserved.

