

Smart **AXIS**

Controller

# FT1A



CE UK CA cUL US LISTED

• See website for details on approvals and standards.

Save installation space, wire, and time.

## FT1A controller with small vivid LED display

Touch is an advanced, 3.8-inch display with integrated control and monitor functions. A bright LED backlight provides a vivid display.

Touch



Vertical  
OK

TFT color  
LCD  
3.8 inch  
400 cd/m<sup>2</sup>

STN monochrome  
LCD  
3.7 inch  
740 cd/m<sup>2</sup>



## Touch

Touch is an advanced, 3.8-inch display with integrated control and monitor functions (same functionality as Lite 12-I/O type).



## Pro

Compact, easy-to-use controller. Independent dual axis, high-speed counter, and interrupt input are available. Pro is equipped with an LCD.



## Lite

Compact, easy-to-use controller. Independent dual axis, high-speed counter, and interrupt input are available. Lite is a controller without an LCD.

# SmartAXIS Touch

Save installation space, wire, and time.



## Control Functions

**Fast Processing Speed**

### Stable and efficient processing

Basic instructions processing time: 1850µs/1000 steps. Fast processing time is available in the integrated control function.

**10A Relay**

### No external relay, reducing wiring

Max. 10A output enables direct operation of solenoid valves. No additional circuit necessary to connect a relay, reducing wiring.

**Memory**

### Large memory size enables stress-free programming of easy-to-see screen

Stress-free programming with large memory size - 47.4kB program size (when using ladder program. FBD: 38kB) and 5MB configuration memory capacity.

\*1) System software version V4.05 or later (47.4kB with V4.04 or earlier)

**USB Flash Drive**

### Easy log data saving

Integrated data logging function using a USB memory. Programs can also be changed easily.

**High Speed**

### High-speed counter

Fast counter (single-phase 10 kHz/4 point, two-phase 5 kHz/1 point).

## Structure

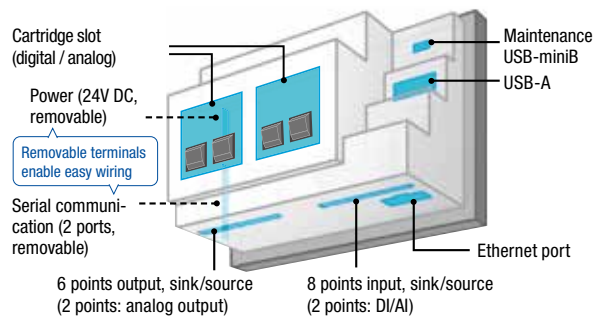

## Display Functions

**Color LCD**

### 65,536-color high-resolution TFT LCD

Brightest LCD in its class. Compact screen with unparalleled visibility.



**Mono-chrome**

### Backlit with pink, red, or white colors

Check the system status easily with the super-bright display with pink, red, or white backlight. Displays the same level of brightness as the color LCD models.



Different error levels can be displayed.

**Fast start-up**

### Stress-free, 3-second start-up

Fast start-up allows for easy debugging and stress-free operation.

**32-level Brightness Adjustment**

### LED backlight dimming control

The brightness of the backlight can be adjusted according to surrounding conditions (day/night), saving energy.

**Rear Mount Adapter**

### Flexible system design with rear mount adapter

An adapter to rear mount the Touch. Choose the most suitable mounting method to mount on the equipment.

(The customer should prepare the panel surface sheet and panel cut-out.)



When installed

APEM

Switches & Pilot Lights

Control Boxes

Emergency Stop Switches

Enabling Switches

Safety Products

Explosion Proof

Terminal Blocks

Relays & Sockets

Circuit Protectors

Power Supplies

LED Illumination

Controllers

Operator Interfaces

Sensors

AUTO-ID

FC6A

FT1A

FL1F

# SmartAXIS Pro/Lite

## Controls for various applications



- APEM
- Switches & Pilot Lights
- Control Boxes
- Emergency Stop Switches
- Enabling Switches
- Safety Products
- Explosion Proof
- Terminal Blocks
- Relays & Sockets
- Circuit Protectors
- Power Supplies
- LED Illumination
- Controllers**
- Operator Interfaces
- Sensors
- AUTO-ID
- FC6A
- FT1A**
- FL1F

**Fast Processing Speed**

### Stable and efficient processing

Basic instructions processing time: 950µs/1000 steps

**Memory**

### Large memory size for easy-to-see screen

Large program memory (12 I/O: 12 kB<sup>\*1</sup>, 24 I/O: 47.4 kB<sup>\*2</sup>) achieves reduction of development processes.

\*1: When using ladder program. FBD: 10kB

\*2: When using ladder program. FBD: 38kB

**High Speed Counter**

### Positioning control possible with only one controller

Supports positioning control with a single-phase (100 kHz)/4 point or a single-phase (100 kHz)/two-phase (50 kHz)/2 point high-speed counter input. Ideal for easy positioning or motor control using a rotary encoder. Equipped with 6 points for interrupt input, catch input, and frequency input.

**10A Relay**

### No external relay, reducing wiring

10A output relays connect directly to small motors and solenoid valves. No additional circuit necessary to connect a relay, reducing wiring.



**Memory Cartridge**

### Easy maintenance, no PC required.

User programs can be read or written easily, reducing labor. When a memory cartridge is installed in the SmartAXIS, the user program stored in the memory cartridge is executed.

## Structure

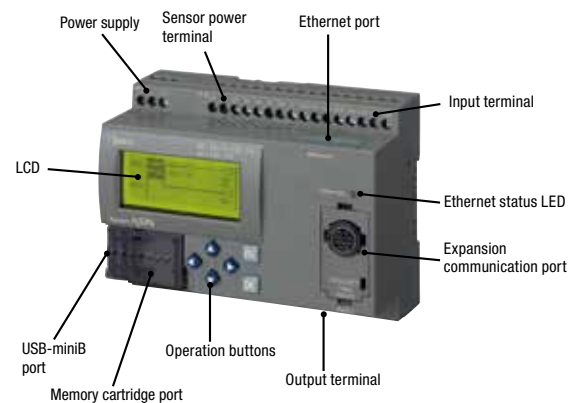

# SmartAXIS Touch/Pro/Lite

- APEM
- Switches & Pilot Lights
- Control Boxes
- Emergency Stop Switches
- Enabling Switches
- Safety Products
- Explosion Proof
- Terminal Blocks
- Relays & Sockets
- Circuit Protectors
- Power Supplies
- LED Illumination
- Controllers**
- Operator Interfaces
- Sensors
- AUTO-ID

- FC6A
- FT1A**
- FL1F

**I/O Monitor**

## “I/O status monitor” screen for monitoring I/O status

The monitor screens on LCD show ON/OFF status of I/Os (Touch/Pro only), enabling quick I/O status monitoring when error occurs.



**Ladder Monitor**

## Easy troubleshooting

Easy ladder program monitoring using 4 buttons. Parameters on monitor screens can be checked and changed easily. (Touch/Pro only) (monitor function is not possible with FBD.)

Touch

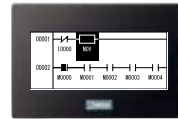

Pro



Inputs from the operation buttons can be programmed as digital inputs. No external device necessary for checking the programs.

**Device Monitor**

## Easy and quick program change

Parameters can be confirmed/checked using the device monitor function of Pro/Touch (monitoring FBD is not possible).

Touch

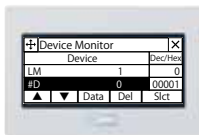

Pro



**Online Monitor**

## Easy set-up

Debugging is possible by connecting the SmartAXIS with WindLDR or WindO/I-N3.

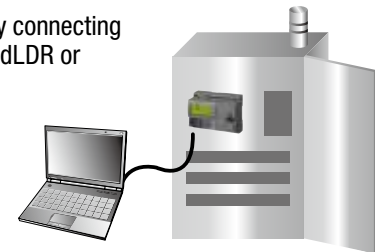

**Clock**

## Easy time schedule control using “Clock Function”

Clock function enables you to automatically control the time schedule for systems such as lighting or water sprinkler.

**Efficiency**

## Digital/analog (0 to 10V DC) compatible input

External analog potentiometer makes it easy to set the timer. Suitable for applications requiring a few analog inputs. (Pro/Lite: DC power model only)

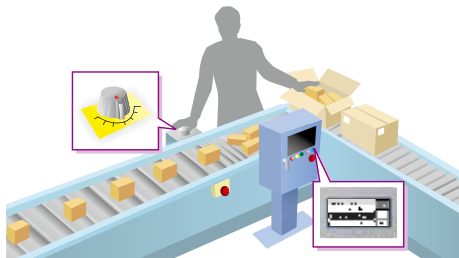

**Ethernet**

## Remote maintenance

The user program can be downloaded to/uploaded from the SmartAXIS at remote locations via Ethernet (except 12 I/O type of Pro/Lite).

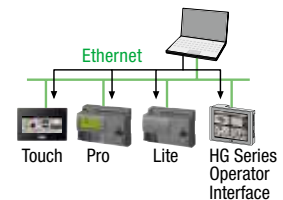

**Front Panel Maintenance**

## Easy data maintenance, shortening setup and adjustment time.

Using a panel mount extension cable, data can be transferred without opening the panel. Debugging of ladder program in the controller is also possible (Touch only).

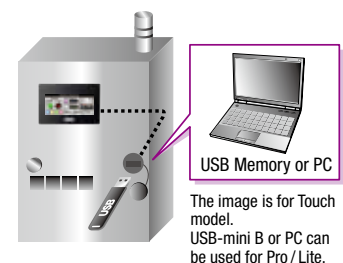

**Security**

## Password protection for secure system operation

Protect systems and programs using a password.



**Operator Interface**

## Connection to Operator Interface

Pro/Lite can be connected to IDEC's HG series operator interface for powerful expressivity and rich information.



Photo: HG3G Operator Interface

# SmartAXIS Pro/Lite

## Various Networks for a Wide Variety of Applications

(Except for 12 I/O type of Pro/Lite)

### User Communication

The user communication of the SmartAXIS enables you to control external devices such as PCs, printers, and barcode readers.

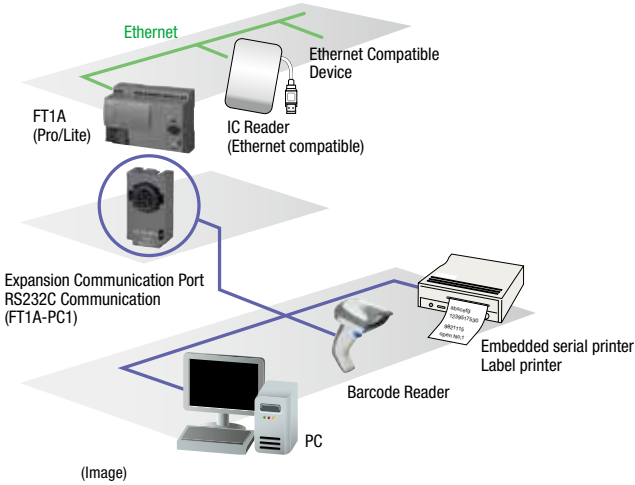

### Modbus RTU Communication

The SmartAXIS is compliant with Modbus protocol and can be used as either a Modbus communication master or slave. When used as a Modbus master, the SmartAXIS can monitor and modify data of Modbus compliant devices such as inverters and temperature controllers using Modbus communication (Touch can be used as a master only).

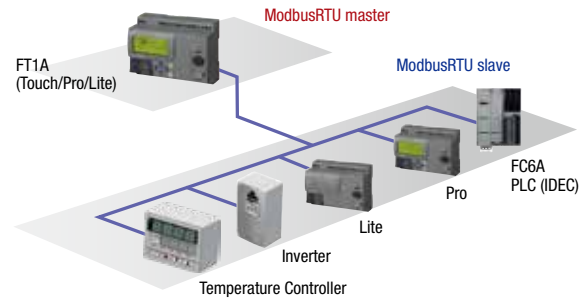

### Modbus TCP

The SmartAXIS supports Modbus communications protocols. Modbus TCP protocol can also be used on the built-in Ethernet port, and can be used as a client (master) or server (slave), to monitor and change data of devices such as inverters and temperature controllers.  
 Note: When Pro/Lite is the client (master): up to 3 servers (slaves) can be connected.  
 When Touch is the client (master): up to 16 servers (slaves) can be connected.

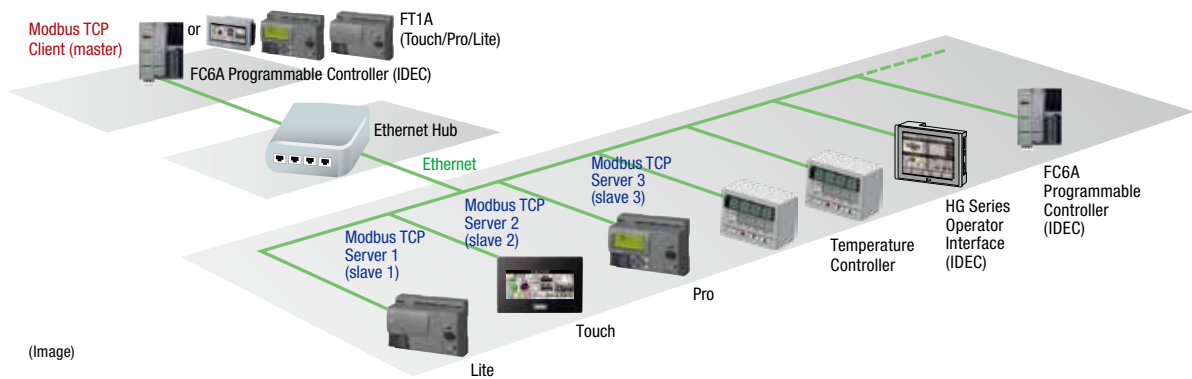

- APEM
- Switches & Pilot Lights
- Control Boxes
- Emergency Stop Switches
- Enabling Switches
- Safety Products
- Explosion Proof
- Terminal Blocks
- Relays & Sockets
- Circuit Protectors
- Power Supplies
- LED Illumination
- Controllers**
- Operator Interfaces
- Sensors
- AUTO-ID

- FC6A
- FT1A**
- FL1F

APEM

Switches & Pilot Lights

Control Boxes

Emergency Stop Switches

Enabling Switches

Safety Products

Explosion Proof

Terminal Blocks

Relays & Sockets

Circuit Protectors

Power Supplies

LED Illumination

Controllers

Operator Interfaces

Sensors

AUTO-ID

FC6A

FT1A

FL1F

## Remote I/O



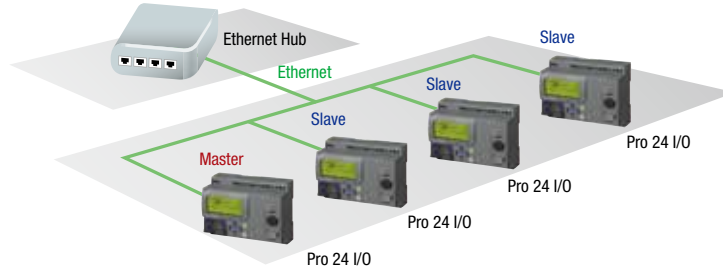

The remote I/O of the SmartAXIS enables you to expand the number of inputs and outputs by connecting separate SmartAXIS modules over Ethernet as remote I/O slaves. The total number of I/Os can be expanded up to 72 I/Os. The SmartAXIS remote I/O master can use the analog inputs on the remote I/O slaves (Pro/Lite only).



(Image)



# SmartAXIS Selection Guide

Specifications		Touch			Pro					
		 Color LCD	 Monochrome LCD							
Part Number		12	14		12	24				
Part Number		FT1A-*12RA-□	FT1A-*14KA-□	FT1A-*14SA-□	FT1A-H12RA	FT1A-H12RC	FT1A-H24RA	FT1A-H24RC		
Power Voltage		24V DC			24V DC	100-240V AC	24V DC	100-240V AC		
I/O Points	No. of Inputs	Digital	Sink 6 points	Source 6 points	Sink 6 points	6 points	8 points	12 points	16 points	
		Analog	2pt (0-10VDC, 10-bit Resolution)		2pt (0-10VDC, 4-20mA, 10-bit Resolution)	2 points	—	4 points	—	
	No. of outputs	Relay output	10A relay	4 points	—	—	4 points	4 points	4 points	4 points
			2A relay	—	—	—	—	—	4 points	4 points
		Transistor (sink output)		—	4 points	—	—	—	—	—
		Transistor (source output)		—	—	4 points	—	—	—	—
Analog output		—	2 points	2 points	—	—	—	—		
Maximum Expansion I/O Points	Analog input/ Analog output (*5)	2/0 points	2/6 points 4/4 points 6/2 points	2/6 points 4/4 points 6/2 points	—	—	—	—		
Ladder Program	Program Capacity		94.8kB (23,700 steps equivalent) (*4) Configuration Memory Capacity: 5MB			12kB (3,000 steps equivalent)		47.4kB (11,850 steps equivalent)		
	Instructions Processing Time	Basic Instruction Time	1,850µs/1,000 steps			950µs/1,000 steps				
		END Processing	5ms minimum			2ms				
FBD	Program Capacity		Program Size: 38kB Configuration Memory Size: 5MB			10kB		38kB		
	Instructions Processing Time	Instruction Time	4ms/100 points			1.3ms/100 points				
		Scan End Processing	5ms minimum			2.5ms				
(Maximum Counter Frequency and Points)	Single/two-phase selectable	1 point (5kHz, 2/4-edge, no single-phase use)			2 points (*1)	—	2 points (*1)	—		
	Single-phase	4 points (×10kHz)			2 points (×100kHz)	—	4 points (×100kHz)	—		
Pulse Output	100kHz	—			—		—			
	5kHz	—			—		—			
Interface	USB Port		2 (USB-A, USB-miniB) (*2)			1 (*2)		1 (*2)		
	Ethernet		1			—		1		
	Expansion Communication Ports		—			—		1		
		RS232C		1			—		1 max. (*3)	
		RS422/485		1			—		1 max. (*3)	
	SD Memory Card		—			—		—		
Memory Cartridge		—			1		1			
USB Memory		○			—		—			
Clock Function		○			○		○			
LCD		TFT color (65,536 colors) STN monochrome (pink/red/white backlight)			○ (STN monochrome)		○ (STN monochrome)			

\* LCD: M (STN monochrome), C (TFT color) □ Bezel color: B (dark gray), S (silver)

\*1) Single-phase: 100kHz, two-phase: 50kHz, 2/4-edge

\*3) When expansion communication cartridge is installed.

\*4) Touch system software version V4.05 or later (47.4KB with V4.04 or earlier) (11,850 steps equivalent)

\*2) USB-miniB (maintenance port)

\*5) Depends on the cartridge combination.

Lite		
		
	12	24
	FT1A-B12RA	FT1A-B24RA
	24V DC	24V DC
	6 points	12 points
	2 points	4 points
	4 points	4 points
	—	4 points
	—	—
	—	—
	—	—
	—	—
	12kB (3,000 steps equivalent)	47.4kB (11,850 steps equivalent)
	950µs/1,000 steps	
	640µs	
	10kB	38kB
	1.3ms/100 points	
	1ms	
	2 points (*1)	2 points (*1)
	2 points (×100kHz)	4 points (×100kHz)
	—	—
	—	—
	1 (*2)	1 (*2)
	—	1
	—	1
	—	1 max. (*3)
	—	1 max. (*3)
	—	—
	1	1
	—	—
	○	○
	—	—

APEM

Switches & Pilot Lights

Control Boxes

Emergency Stop Switches

Enabling Switches

Safety Products

Explosion Proof

Terminal Blocks

Relays & Sockets

Circuit Protectors

Power Supplies

LED Illumination

**Controllers**

Operator Interfaces

Sensors

AUTO-ID

FC6A

**FT1A**

FL1F



# SmartAXIS Series FT1A Controller

## FT1A

### Touch (Display Models)

Package Quantity: 1

Type	Power	I/O	Input		Output	Program Size (ladder/FBD)	Interfaces	LCD	Bezel Color	Part No.
			Digital I/O (24V DC)	Analog I/O (*1)						
APEM Switches & Pilot Lights Control Boxes Emergency Stop Switches Enabling Switches Safety Products Explosion Proof	24V DC	12 points (8/4)	6 (sink)	2	4 points 10A relay output	Program size: 94.8 (*3)/38kB Configuration memory size: 5 MB	USB-A USB-mini B RS232C RS422/485 Ethernet	STN monochrome	Dark gray	FT1A-M12RA-B
		14 points (8/6)	6 (source)	2	4 points Tr. sink output 2 points analog output			TFT color	Silver	FT1A-M12RA-S
6 (sink)	2					4 points Tr. source output 2 points analog output	Dark gray	FT1A-C12RA-B		
			6 (source)	2	4 points Tr. sink output 2 points analog output		Silver	FT1A-C12RA-S		
6 (sink)	2					4 points Tr. source output 2 points analog output	STN monochrome	Dark gray	FT1A-M14KA-B	
		Silver	FT1A-M14KA-S							
Dark gray	FT1A-M14SA-B									
Silver	FT1A-M14SA-S									
TFT color	Dark gray	FT1A-C14KA-B								
Silver	FT1A-C14KA-S									
Dark gray	FT1A-C14SA-B									
Silver	FT1A-C14SA-S									

### Pro (LCD Models)

Package Quantity: 1

Power	I/O	Input		Output	High-Speed Tr. Output	Program Size (ladder/FBD)	Interfaces				Memory Cartridge	SD Memory Card	Part No.	
		Digital I/O	Analog I/O (*1)				USB mini-B Port	Ethernet Port	Expansion communication port (*2)					
								Port 2	Port 3					
24V DC	12 points (8/4)	24V DC Input	6	2	4 points 10A relay output	—	12/10 kB	—	—	—	—	—	—	FT1A-H12RA
	24 points (16/8)		12	4	4 points 10A relay output 4 points 2A relay output			47.4/38 kB	○					○
100 to 240V AC	12 points (8/4)	24V DC Input	8	—	4 points 10A relay output	—	12/10 kB	—	—	—	—	—	—	FT1A-H12RC
	24 points (16/8)		16	—	4 points 10A relay output 4 points 2A relay output			47.4/38 kB	○					○

### Lite (No LCD Models)

Package Quantity: 1

Power	I/O	Input		Output	High-Speed Tr. Output	Program Size (ladder/FBD)	Interfaces				Memory Cartridge	SD Memory Card	Part No.	
		Digital I/O	Analog I/O (*1)				USB mini-B Port	Ethernet Port	Expansion communication port (*2)					
								Port 2	Port 3					
24V DC	12 points (8/4)	24V DC Input	6	2	4 points 10A relay output	—	12/10 kB	—	—	—	—	—	—	FT1A-B12RA
	24 points (16/8)		12	4	4 points 10A relay output 4 points 2A relay output			47.4/38 kB	○					○

\*1) Digital/analog-compatible input

\*2) The following communication cartridges can be connected.

FT1A-PC1: RS232C, mini-DIN type, FT1A-PC2: RS485, mini-DIN type, FT1A-PC3: RS485, terminal block type

\*3) Touch system software version V4.05 or later (47.4KB with V4.04 or earlier).

Options / Maintenance Parts

Options

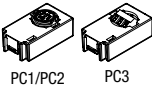
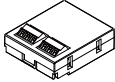
Name/Appearance		Applicable Model			Part No. (Ordering No.)	Package Quantity	Specifications
		Touch	Pro	Lite			
Application software		○	○	○	SW1A-W1C	1	Automation Organizer Ver. 2.0 or higher (*1)
USB maintenance cable		○	○	○	HG9Z-XCM42	1	USB cable (length 2 m), USB-miniB
Panel mount extension cable		○	—	—	HG9Z-XCE11	1	USB-A port extension cable (length 1 m)
		○	○	○	HG9Z-XCE21	1	USB-mini B port extension cable (length 1 m)
Screen protection sheet (*2)		○	—	—	FT9Z-1D3PN05	5	
Protective cover		○	—	—	FT9Z-1E3PN05	5	
Memory card		— (*3)	○ (*4)	○ (*4)	HG9Z-XMS2	1	SD memory card (2 GB)
Memory cartridge		—	○	○	FT1A-PM1	1	Dedicated user program save memory (1 MB)
Communication cartridge 		—	○ (*5)	○ (*5)	FT1A-PC1	1	RS232C, mini-DIN type
		—	○ (*5)	○ (*5)	FT1A-PC2	1	RS485, mini-DIN type
		—	○ (*5)	○ (*5)	FT1A-PC3	1	RS485, terminal block type
Digital I/O Cartridge	Digital Input	○ (*5)	—	—	FC6A-PN4	1	4 (4/1 common)
	Digital Output	○ (*5)	—	—	FC6A-PTK4	1	4 sink (4/1 common)
		○ (*5)	—	—	FC6A-PTS4	1	4 source (4/1 common)
Analog cartridge 		○ (*6)	—	—	FC6A-PJ2A	1	Voltage/current input (2 points)
		○ (*6)	—	—	FC6A-PK2AV	1	Voltage output (2 points)
		○ (*6)	—	—	FC6A-PK2AW	1	Current output (2 points)
		○ (*6)	—	—	FC6A-PJ2CP	1	Temperature input (2 points)
Rear mount adapter		○	—	—	FT9Z-1A01	1	Rear mount bracket
35-mm-wide DIN Rail		—	○	○	BAA1000PN10	10	See H-071 for details on DIN rail products.
DIN rail end clip		—	○	○	BNL6PN10	10	
Touch User's Manual	Japanese	○	—	—	FT9Y-B1389	1	
	English	○	—	—	FT9Y-B1390	1	
Pro/Lite User's Manual	Japanese	—	○	○	FT9Y-B1377	1	
	English	—	○	○	FT9Y-B1378	1	
SmartAXIS Ladder Programming Manual	Japanese	○	○	○	FT9Y-B1381	1	
	English	○	○	○	FT9Y-B1382	1	
FBD Programming Manual	Japanese	○	○	○	FT9Y-B1385	1	
	English	○	○	○	FT9Y-B1386	1	

\*1) Upgrade from earlier version is possible on IDEC website. The following manuals in PDF can be downloaded from <http://www.idec.com/language>.

- FT1A SmartAXIS Touch User's Manual (English, Japanese, Simplified Chinese)
- FT1A SmartAXIS Pro/Lite User's Manual (English, German, Japanese, Simplified Chinese)
- FT1A SmartAXIS Ladder Programming Manual (English, German, Japanese, Simplified Chinese)
- FT1A SmartAXIS FBD Programming Manual (English, German, Japanese, Simplified Chinese)

\*2) UV resistance material is used. However, resistance against direct sunlight in outdoor usage is not guaranteed.





\*3) Use commercially-available USB memory to store project data, log data, and recipe file of Touch models.

\*4) Can be used for 40-I/O and 48-I/O types. Note that user programs cannot be stored or read using an SD memory card. If necessary, use a memory cartridge.

\*5) Cannot be used for expansion with 12-I/O type.

\*6) Cannot be used for expansion with relay output type.

Maintenance Parts

Name	Applicable Model (*1)			Part No. (Ordering No.)	Package Quantity	Specification
	Touch	Pro	Lite			
Communication Interface plug 	○	—	—	FT9Z-1T09	1	For communication ports (black) One supplied with Touch
Power supply plug 	○	—	—	FT9Z-1X03	1	For power supply terminals (black) One supplied with Touch
Mounting bracket 	○	—	—	HG9Z-4K2PN04	4	Two sets Two supplied with Touch
USB cable lock pin 	○	—	—	HG9Z-XU1PN05	5	Used when using the USB cable on a regular basis Two supplied with Touch
Direct mounting hook 	—	○	○	FT9Z-PSP1PN05	5	Direct mounting hook for Pro/Lite One set supplied with Pro/Lite

\*1) Supplied with FT1A.

- APEM
- Switches & Pilot Lights
- Control Boxes
- Emergency Stop Switches
- Enabling Switches
- Safety Products
- Explosion Proof
- Terminal Blocks
- Relays & Sockets
- Circuit Protectors
- Power Supplies
- LED Illumination
- Controllers
- Operator Interfaces
- Sensors
- AUTO-ID
- FC6A
- FT1A
- FL1F

# FT1A Controllers

## General Specifications

### Touch (Display Model)

Part No.	FT1A-*12RA-*	FT1A-*14KA-* / FT1A-*14SA-*
Output	Relay output	Transistor output
Rated Power Voltage/ Power Supply Isolation	24V DC/Not isolated	
Allowable Voltage Range	20.4 to 28.8V DC (including ripple)	
Power Consumption	9.2W maximum	11W maximum
Allowable Momentary Power Interruption	10 ms maximum	
Dielectric Strength	1. Between power terminal and FE terminal: 500V AC, 5 mA, 1 minute 2. Between power terminal and output terminal: 2,300V AC, 5 mA, 1 minute	1. Between power terminal and FE terminal: 500V AC, 5 mA, 1 minute 2. Between power terminal and output terminal: 500V AC, 5 mA, 1 minute
EMC Immunity	IEC/EN 61131-2:2007 compliant	
Inrush Current	50A maximum (5ms maximum)	
Operating Temperature	Color display: -20 to +55°C, Monochrome display: 0 to +55°C (*1) (*2)	
Storage Temperature	-20 to +60°C (no freezing)	
Relative Humidity	10 to 95% RH (no condensation)	
Pollution Degree	2 (IEC 60664-1)	
Corrosion Immunity	Atmosphere free from corrosive gases	
Degree of Protection	IP66F TYPE 4X TYPE 13 (Panel front) (*3), IP20 (Rear)	
Ground	Functional grounding	
Protective grounding conductor	UL1007 AWG16	
Vibration Resistance	5 to 8.4 Hz half amplitude 3.5 mm, 8.4 to 150 Hz, acceleration 9.8 m/s <sup>2</sup> (1G), 2 hours per axis on each of three mutually perpendicular axis (IEC 61131-2)	
Shock Resistance	147 m/s <sup>2</sup> , 11 ms, X, Y, Z directions 3 times (IEC 61131-2)	
Mounting Structure	Panel mount	
Weight (approx.)	300g	250g

\*1) FT1A-\*12RA-\* hardware version V130 (indicated on hardware) and earlier is UL, c-UL listed at 50°C (maximum operating temperature).

\*2) See SmartAXIS Touch User's Manual FT9Y-B1390(2) for I/O derating.

\*3) Operation not guaranteed when used with certain types of oils.

### Pro/Lite (LCD Model/No LCD Model)

Part No.	Pro/Lite			
	12-I/O Type		24-I/O Type	
	H12RA	H12RC	H24RA	H24RC
Rated Power Voltage/Power Supply Isolation	AC power: 100 to 240V AC/Isolation with transformer DC power: 24V DC/Not isolated			
Allowable Voltage Range	AC power: 85 to 264V AC DC power: 20.4 to 28.8V DC (including ripple)			
Rated Power Frequency	AC power: 50 to 60 Hz (47 to 63 Hz)			
Power Consumption	AC power	12-I/O: 18 VA maximum, 24-I/O: 41 VA maximum		
	DC power	12-I/O: 4.3W maximum, 24-I/O: 4.8W maximum		
Allowable Momentary Power Interruption	AC power: 20 ms maximum, DC power: 10 ms maximum			
Dielectric Strength	AC power type: Between power/input and PE terminals: 1,500V AC, 5mA, 1 minute Between transistor output and PE terminals: 1,500V AC, 5mA, 1 minute Between relay output and PE terminals: 2,300V AC, 5mA, 1 minute Between power and input terminals: 1,500V AC, 5mA, 1 minute Between power/input and transistor output terminals: 1,500V AC, 5mA, 1 minute Between power/input and relay output terminals: 2,300V AC, 5mA, 1 minute DC power type: Between power/input and FE terminals: 500V AC, 5mA, 1 minute Between transistor output and FE terminals: 500V AC, 5mA, 1 minute Between relay output and FE terminals: 2,300V AC, 5mA, 1 minute Between power/input and transistor output terminals: 500V AC, 5mA, 1 minute Between power/input and relay output terminals: 2,300V AC, 5mA, 1 minute			
EMC Immunity	IEC/EN 61131-2:2007 compliant			
Inrush Current	AC power: 35A maximum (Cold start with Ta=25°C, 200V AC) DC power: 30A maximum (5ms maximum)			
Operating Temperature	0 to +55°C (*1)			
Storage Temperature	-25 to +70°C (no freezing)			
Relative Humidity	10 to 95% RH (no condensation)			
Pollution Degree	2 (IEC 60664-1)			
Corrosion Immunity	Atmosphere free from corrosive gases			
Degree of Protection	IP20 (IEC 60529)			
Ground	D-type ground (Class 3 ground)			
Protective grounding conductor	UL1007 AWG16			
Vibration Resistance	5 to 8.4 Hz half amplitude 3.5 mm, 8.4 to 150 Hz, acceleration 9.8 m/s <sup>2</sup> (1G), 2 hours per axis on each of three mutually perpendicular axis (IEC 61131-2)			
Shock Resistance	147 m/s <sup>2</sup> , 11 ms, X, Y, Z directions 3 times (IEC 61131-2)			
Mounting Structure	DIN rail or direct mount			
Weight (approx.)	AC power	12-I/O: 230g, 24-I/O: 400g		
	DC power	12-I/O: 190g, 24-I/O: 310g		

\*1) Hardware version V110 (indicated on hardware) is UL, c-UL Listed at 50°C (maximum operating temperature).

Function Specifications (Touch)

Part No.		Touch		
		FT1A-*12RA-*	FT1A-*14KA-*	FT1A-*14SA-*
Control System		Stored program system		
Ladder Program	Instruction Words	Basic Instructions		42 types
		Advanced Instructions		98 types
	Program Capacity	99 types		
Processing Time	Basic Instruction	1850µs/1,000 steps		
	END Processing	5 msec minimum		
FB		37 types		
Program Capacity		Program size: 38kB, configuration memory capacity: 5MB		
FBD	No. of FB	FB (*1)	1,000	
		Timer (T)	200	
		Counter (C)	200	
	Processing Time	Basic Instruction	4ms/100	
END Processing		5ms minimum		
User Program Storage		Flash ROM (100,000 times)		
I/O Points (*3)	Inputs	8 (90 max. can be added with remote I/O master function)	8 (90 max. can be added with remote I/O master function)	
	Outputs	4 (54 max. can be added with remote I/O master function)	4 (54 max. can be added with remote I/O master function)	
Analog Input (*3)		2 (24 max. can be added with remote I/O master function)	2 (4 max. can be added with analog cartridge, and 24 max. can be added with remote master function)	
Analog Output		—	2 (4 max. can be added with analog cartridge)	
Internal Relays		1,024		
Shift Registers		128		
Data Registers		2000		
Special Data Registers		200		
Counters		200		
Timer (1ms, 10 ms, 100 ms, 1s)		200		
Clock		Precision: ±30 seconds/month (25°C, typical)		
RAM Backup	Backup Data	Internal relays, shift registers, counters, data registers, clock data		
	Backup Duration	Approximately 30 days (typical) at 25°C after backup battery is fully charged		
	Battery	Lithium secondary battery		
	Charging Time	Approximately 15 hours required to charge from 0 to 90%		
	Replaceability	Not possible		
Self-Diagnostic Functions		Keep data check, power failure check, watchdog timer check, timer/counter preset value change error check, user program syntax check, user program execution check		
Input Filter		No filter, 3 to 15 ms (selectable in increments of 1 ms)		
Catch Input/Interrupt Input		4/4		
High-speed Counter	Maximum Counting Frequency and Points	Single/two-phase selectable	1 (5 kHz, multiple 2/4, single-phase cannot be used)	
		Single-phase	4 (x 10 kHz)	
	Counting Range	0 to 4,294,967,295 (32 bits)		
	Operation Mode	Rotary encoder mode and adding counter mode		
Analog Voltage Inputs	Built-in Points	2		
	Input Range	0 to 10V DC	0 to 10V DC (voltage input) / 4 to 20 mA (current input)	
	Input Impedance	78 kΩ	78 kΩ (voltage input) / 250 Ω (current input)	
	Digital Resolution	0 to 1,000 (10 bits)		
Number of Relay Outputs		10A relay: 4		
Number of Transistor Outputs		—	4 (sink)	4 (source)
Analog Output	Built-in Points	—	2	
	Output Range	—	0 to 10V DC (voltage output) / 4 to 20 mA (current output)	
	Digital Resolution	—	0 to 1,000 (10 bits)	
Pulse Outputs	100 kHz	No. of outputs	—	
		Function	—	
	5 kHz	No. of outputs	—	
		Function	—	
External Output Power Supply for Sensor	Output Voltage	—		
	Output Current	—		
	Overload Detection	—		
	Insulation	—		
USB-mini B (*2)		○		
USB-A (*2)		○		
RS232C (*2)		○		
RS485/422 (*2)		○		
Ethernet		○		
Expansion Communication Ports	Port 2	—		
	Port 3	—		
Memory Cartridge		—		
SD Memory Card		—		
Analog Cartridge Interface	Number of Ports	—	2	
	Connectable Cards	—	4 (FC6A-PJ2A, FC6A-PK2AW, FC6A-PK2AW, FC6A-PJ2CP)	

\*1) Except for timer, counter, input FB, and output FB.  
 \*3) FT1A-\*12RA-\*: system software V3.90 or later

\*2) Not isolated from internal circuits.  
 \*4) Touch system software version V4.05 or later (47.4KB with V4.04 or earlier)

- APEM
- Switches & Pilot Lights
- Control Boxes
- Emergency Stop Switches
- Enabling Switches
- Safety Products
- Explosion Proof
- Terminal Blocks
- Relays & Sockets
- Circuit Protectors
- Power Supplies
- LED Illumination
- Controllers
- Operator Interfaces
- Sensors
- AUTO-ID
- FC6A
- FT1A
- FL1F

# FT1A Controllers

## Function Specifications (Pro/Lite)

Part No.	Pro/Lite FT1A-							
	H12RA B12RA	H12RC	H24RA B24RA	H24RC				
Control System		Stored program system						
APEM Switches & Pilot Lights Control Boxes Emergency Stop Switches Enabling Switches Safety Products Explosion Proof Terminal Blocks Relays & Sockets Circuit Protectors Power Supplies LED Illumination	Ladder Program	Instruction Words	Basic Instructions 42 types	Advanced Instructions 99 types	98 types	103 types	102 types	
		Program Capacity	12 kB (3000 steps equivalent)		47.4 kB (11,850 steps equivalent)			
	Processing Time	Basic Instruction	950 μs/1,000 steps					
		END Processing	2 ms (Pro) / 640 μs (Lite)					
FBD	FB	38 types	37 types	38 types	37 types			
	Program Capacity	10kB		38kB				
	No. of FB	FB (*1)	200					
		Timer (T)	100					
		Counter (C)	100					
	Processing Time	Basic Instruction	1.3ms/100					
END Processing		2.5ms (Pro)/1ms (Lite)						
User Program Storage		Flash ROM (10,000 times)						
I/O Points	Inputs	8		16				
	Outputs	4		8				
Internal Relays	256		1,024					
Shift Registers	128		128					
Data Registers	400		2000					
Special Data Registers	200		200					
Adding/Reversible Counters	100		200					
Timer (1ms, 10 ms, 10 ms, 1s)	100		200					
Clock		Precision: ±30 seconds/month (25°C, typical)						
Operator Interfaces Sensors AUTO-ID	RAM Backup	Backup Data	Internal relays, shift registers, counters, data registers, clock data					
		Backup Duration	Approximately 30 days (typical) at 25°C after backup battery is fully charged					
		Battery	Lithium secondary battery					
		Charging Time	Approximately 15 hours required to charge from 0 to 90%					
		Replaceability	Not possible					
Self-Diagnostic Functions		Keep data check, power failure check, clock error check, watchdog timer check, timer/counter preset value change error check, user program syntax check, user program execution check, system error check, memory cartridge transfer error check						
Input Filter		No filter, 3 to 15 ms (selectable in increments of 1 ms)						
Catch Input/Interrupt Input		4/4		6/6				
FC6A FT1A FL1F	High-speed Counter	Maximum Counting Frequency and Points	Single/two-phase selectable	2 (*2)	—	2 (*2)	—	
			Single-phase	2 (x 100 kHz)	—	4 (x 100 kHz)	—	
		Counting Range		0 to 4,294,967,295 (32 bits)				
		Operation Mode		Rotary encoder mode and adding counter mode				
Analog Voltage Inputs	Points	2	None	4	None			
	Input Range	0 to 10V DC						
	Input Impedance	78 kΩ						
	Digital Resolution	0 to 1,000 (10 bits)						
Pulse Outputs	100 kHz	No. of outputs	—	—	—	—		
		Function	—	—	—	—		
	5 kHz	No. of outputs	—	—	—	—		
		Function	—	—	—	—		
External Output Power Supply for Sensor	Output Voltage	—	—	—	—	24V DC (+10%, -15%)		
	Output Current	—	—	—	—	250 mA		
	Overload Detection	—	—	—	—	Impossible		
	Insulation	—	—	—	—	Internal Circuit		
USB-mini B (*3)		○		○				
USB-A (*3)		—		—				
RS232C (*3)		—		○ (*4)				
RS485 (*3)		—		○ (*4)				
Ethernet		—		○				
Expansion Communication Ports	Port 2	—		○				
	Port 3	—		—				
Memory Cartridge		○		○				
SD Memory Card		—		—				

\*1) Except for timer, counter, input FB, and output FB.

\*2) 100 kHz when single-phase, 50 kHz when two-phase, multiple 2.4

\*3) Not isolated from internal circuits.

\*4) When communication cartridge is installed.

## Display Specifications

### Touch/Pro (Display Model/Built-in LCD)

Part No.	Touch		Pro
Display Element	TFT color LCD	STN monochrome LCD	STN monochrome LCD
Colors/Shades	65,536 colors	Monochrome 8 shades	Monochrome
Effective Display Area	88.92 W x 37.05 H mm	87.59 W x 35.49 H mm	47.98 W x 18.22 H mm
Display Resolution	240 W x 100 H pixels		192 W x 64 H pixels
View Angle	Left/right 40°, top 20°, bottom 60°	Left/right/top/bottom: 45°	Left/right 30°, top 20°, bottom 40°
Contrast Adjustment	Not possible	32 levels	Not possible
Backlight	LED	LED (white, red, pink)	LED (green)
Backlight Life	50,000 hours (Note 1)		—
Brightness	400 cd/m <sup>2</sup> (Note 2)	740 cd/m <sup>2</sup> (Note 2)	45 cd/m <sup>2</sup>
Brightness Adjustment	32 levels		Not possible
Backlight Control	Auto off function		On/off
Backlight Replacement	Not possible		
Display Character Size	1/4 Size	8 x 8 pixels [JIS 8-bit code, ISO 8859-1 (Western European languages), ANSI 1250 (central Europe)], ANSI 1257 (Baltic), ANSI 1251 (Cyrillic)	—
	1/2 Size	8 x 16 pixels [JIS 8-bit code, ISO 8859-1 (Western European languages), ANSI 1250 (central Europe) ], ANSI 1257 (Baltic), ANSI 1251 (Cyrillic)	8 x 16 pixels [JIS 8-bit code, ISO 8859-1 (Western European languages), ANSI 1251 (Cyrillic)
		16 x 32 pixels, 24 x 48 pixels, 32 x 64 pixels (Western European languages: ISO 8859-1)	—
	Full Size	16 x 16 pixels (Japanese JIS first and second level characters, simplified Chinese, traditional Chinese, Korean)	16 x 16 pixels (Japanese JIS first level characters, Chinese)
Double Size	32 x 32 pixels (Japanese JIS first level characters, Mincho font)	—	
No. of Characters	1/4 Size	30 characters x 12 lines/screen	—
	1/2 Size	30 characters x 6 lines/screen	24 characters x 4 lines
	Full Size	15 characters x 6 lines/screen	12 characters x 4 lines
	Double Size	7 characters x 3 lines/screen	—
Character Magnification	0.5x, 1x, 2x, 3x, 4x, 5x, 6x, 7x, 8x vertically and horizontally		—
Character Attributes	Blink, reverse, bold, shadowed (blink is 1 sec or 0.5 sec)		Blink, reverse
Graphics	Line, polyline, polygon, rectangle, circle, ellipse, arc, pie, equilateral polygons (3, 4, 5, 6, 8), fill, picture		—
Window Display	3 popup screens + 1 system screen		—

Note 1: The backlight life refers to the time until the brightness reduces by half after use at 25°C.

Note 2: Brightness of LCD only (monochrome LCD: when lit white).

## Operation Specifications

### Touch/Pro (Display/LCD Models)

Part No.	Touch	Pro
Switching Element	Analog resistive membrane (touch panel)	Rubber switches
Operating Force	0.2 to 2.5N	2.0 N minimum
Mechanical Life	1 million operations	10,000 operations
Acknowledgment Sound	Electric Buzzer	Not provided
Multiple Press	Not possible	Possible

## HMI Function Specifications (Touch)

Functions	Drawings, bit button, word button, goto screen button, key button, multi-button, keypad, selector switch, potentiometer, numerical input, character input, pilot lamp, picture display, message display, message switching display, alarm list display, alarm log display, numerical display, bar chart, line chart, pie chart, meter, calendar, bit write command, word write command, goto screen command, timer, script command, multi-command, system area, start time, Auto Backlight OFF, O/I Link, user communication, maintenance communication, DM Link Communication, PLC Link Communication (Note 1), alarm log, data log, operation log, data storage area, preventive maintenance, recipe, text group, global script, user account, project data transfer using external memory, downloading logged data in external memory, USB auto-run function
-----------	---

Note 1: The up-to-date information on the connectable PLC can be obtained from <http://www.idec.com/language>.

- APEM
- Switches & Pilot Lights
- Control Boxes
- Emergency Stop Switches
- Enabling Switches
- Safety Products
- Explosion Proof
- Terminal Blocks
- Relays & Sockets
- Circuit Protectors
- Power Supplies
- LED Illumination
- Controllers**
- Operator Interfaces
- Sensors
- AUTO-ID
- FC6A
- FT1A**
- FL1F

Input Specifications (Touch/Pro/Lite)

Part No.	Touch FT1A-			Pro/Lite FT1A-					
	*12RA-*	*14KA-*	*14SA-*	H12RA B12RA	H12RC	H24RA B24RA	H24RC		
Digital Input	Input Points	6			6	8	12	16	
	Input Type	Sink	Source	Sink	Sink	No-voltage (with contact)	Sink	Sink/Source	
	Input Voltage Range	0 to 28.8V DC							
	Rated Input Current	4.4 mA	5.2 mA	4.4 mA	No-voltage type and sink/source type: 5.3 mA, sink type: 4.4 mA, source type: 5.2 mA				
	Input Impedance	5.5 kΩ	4.7 kΩ	5.5 kΩ	No-voltage type and sink/source type: 4.3 kΩ, sink type: 5.5 kΩ, source type: 4.7 kΩ				
	Input Delay Time	OFF → ON	2.5 μs + soft filter setting			40 μs + filter value (high-speed input section: 2.5 μs + soft filter value)			
		ON → OFF	5 μs + soft filter setting			150 μs + filter value (high-speed input section: 5 μs + soft filter value)			
	Isolation	Between input terminals	Not isolated			Not isolated			
		Internal circuit	Not isolated			No-voltage type and sink/source type: optocoupler isolated, sink type and source type: not isolated			
	Input Type	Type 1 (IEC 61131-2)							
	External Load for I/O Interconnection	Not needed							
	Operating Level	OFF voltage	Sink type: 5V DC max. Source type: 15V DC min.			No-voltage type: 18 kΩ min., sink/source type and sink type: 5 VDC max., source type: 15 VDC min.			
		ON voltage	Sink type: 15V DC min. Source type: 5V DC max.			No-voltage type: 2 kΩ max., sink/source type and sink type: 15 VDC min., source type: 5 VDC max.			
		OFF current	Sink type: 0.9 mA max. Source type: -1.0 mA min.			No-voltage type and sink/source type: 1.1 mA max., sink type: 0.9 mA max., source type: -1.0 mA min.			
ON current		Sink type: 2.7 mA min. Source type: -3.0 mA max.			No-voltage type and sink/source type: 3.0 mA min., sink type: 2.7 mA min., source type: -3.0 mA max.				
Analog Input	Input Points	2			2	—	4	—	
	Input Type	Voltage input	Voltage/Current input		Voltage input		Voltage input		
	Input Range	0 to 10.0 VDC	0 to 10.0 VDC / 4 to 20 mA		0 to 10.0V DC		0 to 10.0V DC		
	Sampling Duration Time	2 ms maximum			2 ms maximum		2 ms maximum		
	Total Input System Transfer Time	3 ms + sampling time + scan time	3 ms + sampling time + scan time (voltage input) 12 ms + sampling time + scan time (current input)		2 ms + filtering time + scan time		2 ms + filtering time + scan time		
	Digital Resolution	0 to 1,000 (10 bits)			0 to 1,000 (10 bits)		0 to 1,000 (10 bits)		
	Input Error	25°C	±3% of full scale				±1.5% of full scale		±1.5% of full scale
		Total	±5% of full scale				±5% of full scale		±5% of full scale
	Isolation	Between input terminals	Not isolated				Not isolated		Not isolated
		Internal circuit	Not isolated				Not isolated		Not isolated
When used as digital input	Digital I/O	Type 1 (not conforming to IEC 61131-2 digital I/O type)							
	Operation Level	OFF voltage: 5V maximum							
		ON voltage: 15V minimum							
		OFF current: 0.06 mA maximum ON current: 0.20 mA minimum							
External Power for Input	Input Voltage Range	—			—	—	20.4 to 26.4V DC		
	Output Current Capacity	—			—	—	250 mA		



Output Specifications (Touch/Pro/Lite)

Part No.	Touch FT1A-			Pro/Lite FT1A-			
	*12RA-*	*14KA-*	*14SA-*	H12RA B12RA	H12RC	H24RA B24RA	H24RC
Transistor Output	Output Points Transistor Sink Output	4	—	100%	—	—	—
	Output Points Transistor Source Output	—	4				
	Rated Load Voltage	24V DC					
	Input Voltage Range	20.4 to 28.8V DC					
	Maximum Load Current	0.3A maximum 1A maximum					
	Voltage Drop (ON Voltage)	1V maximum (voltage between COM and output terminals when output is ON)					
	Inrush Current	1A					
	Leakage Current	0.1 mA maximum					
	Clamping Voltage	39V ± 1V					
	Maximum Lamp Load	8 W maximum					
	Inductive Load	L/R = 10 ms (28.8V DC, 1 Hz)					
	External Current Draw	100 mA maximum, 24V DC					
	Isolation	Optocoupler isolated					
	Output Delay	100µS max. 200µS max.					
	10A relay	Output Points	4				
Output Type		1NO contact	—	1NO contact			
Rated Load Current		240V AC 10A, 30V DC 10A	—	240V AC 10A, 30V DC 10A			
Minimum Switching Load		10 mA/5V DC (reference value)	—	10 mA/5V DC (reference value)			
2A relay	Output Points	—	—	—	—	4	4
	Output Points per Common Line	COM4	—	—	—	4	4
	Output Type	—	—	—	—	1a contact	—
	Maximum Load Current	1 point 1 common	—	—	—	240V AC 2A, 30V DC 2A	—
	Minimum Switching Load	—	—	—	—	8A maximum	—
	Initial Contact Resistance	—	—	—	—	1 mA/5 VDC (reference value) 30 mΩ maximum (1A, at 6V DC)	—
Relay Output Common	Electrical Life	100,000 operations minimum (rating 240V AC-10A) (rated resistive load 1,800 operations/h) 50,000 operations minimum (rating 30V DC-10A) (rated resistive load 1,800 operations/h)	—	—	100,000 operations minimum (rating 240V AC-10A) (rated resistive load 1,800 operations/h) 50,000 operations minimum (rating 30V DC-10A) (rated resistive load 1,800 operations/h)		
	Mechanical Life	20 million operations minimum (no load 18,000 operations/h)	—	—	20 million operations minimum (no load 18,000 operations/h)		
	Dielectric Strength	Between output terminal and internal circuit 2,300V AC, 1 minute	—	—	2,300V AC, 1 minute		
	Dielectric Strength	Between output terminals (between COMs) 2,300V AC, 1 minute	—	—	2,300V AC, 1 minute		
Analog Output	Output Points	—	2	—			
	Analog Output Signal Type	—	Voltage/Current output (Selectable)	—			
	Analog Output Range	—	0 to 10V DC / 4 to 20mA	—			
	Load Impedance	—	2kΩ min (voltage input) / 500 Ω max (current input)	—			
	Applicable Load Type	—	Resistive Load	—			
	Maximum Deviation at 25°C	—	±0.3% of full scale	—			
	Temperature Coefficient	—	±0.02%/°C of full scale	—			
	Repeatability After Stabilization Time	—	±0.4% of full scale	—			
	Non-linearity	—	±0.01% of full scale	—			
	Output Ripple	—	30mV max. (spike noise not included)	—			
	Overshoot	—	0% (*1)	—			
	Total Error	—	±1.0% of full scale including ripple	—			
	Effect of Improper Output Connection	—	No damage	—			
	Digital Resolution	—	0 to 1,000 (10 bits)	—			
Output Value of LSB	—	10mV (0-10V) / 16µA (4-20mA)	—				
Monotonicity	—	Yes	—				
Current loop open	—	Not detectable	—				

\*1) Overshoot may occur under light load conditions. Overshoot can be suppressed by inserting a damping resistor. Damping resistor value: approx. 150Ω including the input impedance.

- APEM
- Switches & Pilot Lights
- Control Boxes
- Emergency Stop Switches
- Enabling Switches
- Safety Products
- Explosion Proof
- Terminal Blocks
- Relays & Sockets
- Circuit Protectors
- Power Supplies
- LED Illumination
- Controllers
- Operator Interfaces
- Sensors
- AUTO-ID
- FC6A
- FT1A
- FL1F

Cartridges

Digital I/O Cartridge Specifications

Input Cartridge

Part No.	FC6A-PN4	
Input Points	4 (4/1 common)	
Rated Input Voltage	12/24V DC sink/source input signal	
Input Voltage Range	0 to 28.8V DC	
Rated Input Current	2.5 mA/point (12V DC) 5mA/point (24V DC)	
Input Impedance	4.4 kΩ	
OFF Voltage	5V maximum	
ON Voltage	8.5V minimum	
OFF Current	0.9 mA maximum	
ON Current	1.7 mA minimum (at 8.5V DC)	
Input Delay Time (24V DC)	Turn ON	0.5ms
	Turn OFF	0.5ms
Isolation	Between input terminals: Not isolated Internal circuit: Optocoupler-isolated	
External Load for I/O Interconnection	Not needed	
Signal Determination Method	Static	
Effect of Improper Input Connection	Both sink and source input signals can be connected. If any input exceeding the rated value is applied, permanent damage may be caused.	
Internal Current Draw	All Inputs ON	35mA (3.3V DC) 0mA (24V DC)
	All Inputs OFF	30mA (3.3V DC) 0mA (24V DC)
Internal Power Consumption (at 24V DC while all inputs ON)	0.10W	
Cable Length	3m in compliance with electromagnetic immunity	
Applicable Ferrule	1-wire: AI 0.5-8 WH (Phoenix Contact)	
Weight (approx.)	15g	

Output Cartridge

Part No.	FC6A-PTK4	FC6A-PTS4
Output Points	4 sink (4/1 common)	4 source (4/1 common)
Rated Input Voltage	12/24V DC	
Input Voltage Range	10.2 to 28.8V DC	
Maximum Load Current	Per Point	0.1A
	Per Common	0.4A
Output Delay	Turn ON	450µs maximum
	Turn OFF	450µs maximum
Isolation	Between input terminals: Not isolated Internal circuit: Optocoupler-isolated	
Voltage Drop (ON Voltage)	1V max (voltage between COM and output terminal when output is on.)	
Inrush Current	1A	
Leakage Current	0.1mA maximum	
Clamping Voltage	Approx. 50V	
Maximum Lamp Load	2.4W	
Inductive Load	L/R=10ms (28.8V DC, 1Hz)	
External Current Draw	100mA maximum, 24V DC (power voltage at the +V terminal terminal at source)	100mA maximum, 24V DC (power voltage at the -V terminal at source)
Overcurrent Protection	No	
Internal Current Draw	All Outputs ON	35mA (3.3V DC) 0mA (24V DC)
	All Outputs OFF	30mA (3.3V DC) 0mA (24V DC)
Internal Power Consumption (at 24V DC while all outputs ON)	0.10W	
Applicable Ferrule	1-wire: AI 0.5-8 WH (Phoenix Contact)	
Weight (approx.)	15g	

FC6A

FT1A

FL1F

Cartridges

Analog Cartridges

Specifications

Part No.	FC6A-PJ2A		FC6A-PJ2CP		FC6A-PK2AV		FC6A-PK2AW	
Type	Voltage/Current Input		Temperature Input		Voltage Output		Current Output	
Number of Input/Output	2		2		2		2	
Rated Voltage	5.0V, 3.3V (supplied from the Touch)							
Consumption Current	5.0V: – 3.3V: 30mA				5.0V: 70mA 3.3V: 30mA		5.0V: 185mA 3.3V: 30mA	
Weight	15g							

Input Specifications

Part No.	FC6A-PJ2A		FC6A-PJ2CP	
Input Type	Voltage Input	Current Input	Resistance Thermometer	Thermocouple
Input Range	0 to 10V DC	4 to 20mA DC 0 to 20mA DC	Pt100: –200 to +850°C Pt1000: –200 to +600°C Ni100: –60 to +180°C Ni1000: –60 to +180°C 3-wire RTD	K: –200 to 1300°C J: –200 to 1000°C R: 0 to 1760°C S: 0 to 1760°C B: 0 to 1820°C E: –200 to 8200°C T: –200 to 400°C N: –200 to 1300°C C: 0 to 2315°C
Input Impedance	1MΩ min.	250Ω max.	1MΩ min.	—
Allowable Conductor Resistance	—		10Ω max.	—
Input Detection Current	—		Typ: 0.2mA, 1.0mA max.	—
AD Conversion	Sample Duration Time	10ms	250ms	
	Sample Interval	20ms	500ms	
	Total Input System Transfer Time	20ms + 1 scan	500ms + 1 scan	
	Type of Input	Single-ended input		
	Operating Mode	Self-scan		
	Conversion Method	SAR		
Input Error	Maximum Error at 25°C	±0.1% of full scale	±0.1% of full scale	±0.1% of full scale Cold junction compensation accuracy ±4.0°C or less Exceptions R, S thermocouple error: ±6.0°C (0 to 200 °C range only) B thermocouple error: Not guaranteed (0 to 300 °C range only) K, J, E, T, N thermocouple error: ±0.4% of full scale (0°C or lower range only)
	Temperature Coefficient	±0.02%/°C of full scale		
	Reproducibility After Stabilization Time	±0.5% of full scale		
	Non-linearity	±0.01% of full scale		
	Maximum Error	±1.0% of full scale		
	Digital Resolution	4096 (12 bits)	Pt100: 10,500 (14 bits) Pt1000: 8,000 (13 bits) Ni100: 2,400 (12 bits) Ni1000: 2,400 (12 bits)	K: 15,000 (14 bits) J: 12,000 (14 bits) R: 17,600 (15 bits) S: 17,600 (15 bits) B: 18,200 (15 bits) E: 10,000 (14 bits) T: 6,000 (13 bits) N: 15,000 (14 bits) C: 23,150 (15 bits)
Data	LSB Input Value	2.44mV (0 to 10V DC)	4.88μA (DC0 to 20mA) 3.91μA (DC4 to 20mA)	0.1°C 0.18°F
	Data Format in Application	Can be arbitrarily set for each channel in the range of –32,768 to 32,773		
	Monotonicity	Yes		
	Maximum Temporary Deviation during Electrical Noise Tests	±4.0% of full scale		
Noise Resistance	Recommended Cable	Shielded twisted pair		Twisted pair
	Crosstalk	1LSB max.		
Isolation	None			
Effect When Input is Incorrectly Wired	No damage			
Maximum Allowable Constant Load (non-destructive)	13V DC	40mA	13V DC	
Input Type Modification	Software programming			
Calibration to Maintain Rated Accuracy	Impossible			

Output Specifications

Part No.	FC6A-PK2AV		FC6A-PK2AW	
Type	Voltage Output		Current Output	
Output Type	Voltage Output	0 to 10V DC	—	
	Current Output	—	4 to 20mA DC	
Load	Impedance	2kΩ min.	500 kΩ max.	
	Load Type	Resistance Load		
D/A Conversion	Cycle Time	20ms		
	Settling Time	40ms max.	20ms max.	
	Total Output System Transfer Type	60ms+1 scan	40ms+1 scan	
Output error	Maximum Error at 25°C	±0.3% of full scale		
	Temperature Coefficient	±0.02%/°C of full scale		
	Reproducibility after Stabilization Time	±0.4% of full scale		
	Non-linearity	±0.01% of full scale		
	Output Ripple	30mV max.		
	Overshoot	0%		
Data	Maximum Error	±1.0% of full scale		
	Effect of Improper Output Terminal Connection	No damage		
	Digital Resolution	4096 (12 bits)		
	LSB Output Value	2.44mV (0 to 10V)	3.91μA (4 to 20mA)	
Noise Resistance	Data Format in Application	0 to 4095 (0 to 10V)	0 to 4095 (4 to 20mA)	
	Monotonicity	Yes		
	Open Current Loop	—	Cannot be detected	
Isolation	Maximum Temporary Deviation during Electrical Noise Tests	±4.0 of full scale		
	Recommended Cable	Shielded twisted pair		
	Crosstalk	1 LSB max.		
Calibration to Maintain Rated Accuracy	Impossible			
Selection of Output Signal Type	Voltage output only		Current output only	

Applicable Wire

Cartridge Part No.	FC6A-PJ2A	FC6A-PJ2CP	FC6A-PK2AV	FC6A-PK2AW
Applicable Wire	0.3mm <sup>2</sup> (AWG22) shielded twisted pair	0.3mm <sup>2</sup> (AWG22) twisted pair	0.3mm <sup>2</sup> (AWG22) shielded twisted pair	

- APEM
- Switches & Pilot Lights
- Control Boxes
- Emergency Stop Switches
- Enabling Switches
- Safety Products
- Explosion Proof
- Terminal Blocks
- Relays & Sockets
- Circuit Protectors
- Power Supplies
- LED Illumination
- Controllers
- Operator Interfaces
- Sensors
- AUTO-ID

- FC6A
- FT1A
- FL1F

# FT1A Controllers

## Expansion Communication Cartridges

### Specifications

Part No.	FT1A-PC1	FT1A-PC2	FT1A-PC3
Termination Connector	Mini DIN	Mini DIN	Screw Terminal block
Standards	EIA RS232C	EIA RS485	EIA RS485
Maximum Baud Rate	115,200 bps	115,200 bps	115,200 bps
Communication Functions	Maintenance communication, User communication, Modbus RTU master/slave	Maintenance communication, User communication, odbus RTU master/slave	Maintenance communication, User communication, Modbus RTU master/slave
Isolation between Internal Circuit and Communication Port	Not isolated	Not isolated	Not isolated
Recommended Communication Cable	Special cable	Special cable	Twisted-pair shielded cable with a minimum core wire of 0.3 mm <sup>2</sup> (Conductor resistance 85 Ω/km maximum, shield resistance 20 Ω/km maximum)
Maximum Cable Length	—	—	200m

### Mounting Hole Layout

#### Touch

FT1A-\*12RA-\*

FT1A-\*14\*A-\*

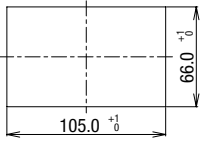

#### Pro/Lite

FT1A-\*12\*\*

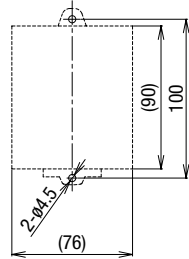

FT1A-\*24\*\*

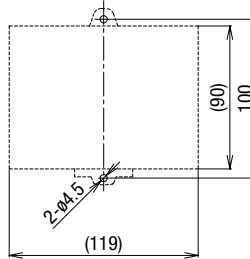

FT1A-\*40\*\*/FT1A-\*48\*\*

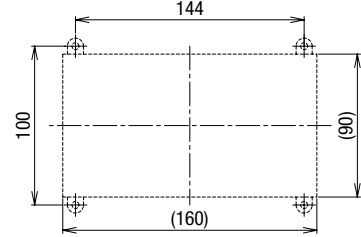

All dimensions in mm.

### Dimensions

#### Touch (Display Model) / Relay Output Model (FT1A-12RA-\*)

##### When using mounting bracket (HG9Z-4K2PN04)

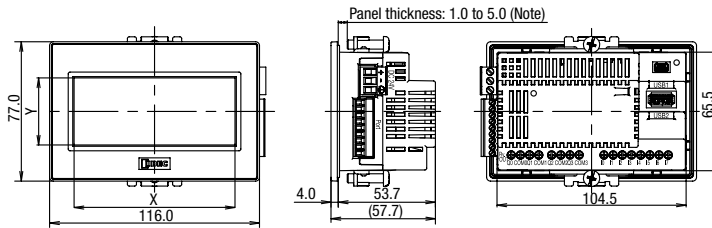

Note: Waterproof characteristic may not be obtained depending on the panel material and size.

##### When using rear mount adapter (FT9Z-1A01)

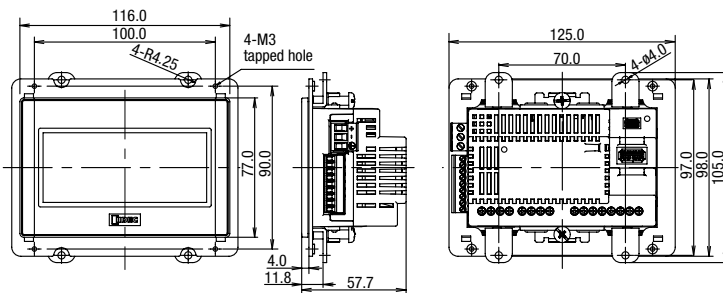

Dimensions

Touch (Display Model)/Transistor Output Model (FT1A-14KA-\* / FT1A-14SA-\*)  
When using mounting bracket (HG9Z-4K2PN04)

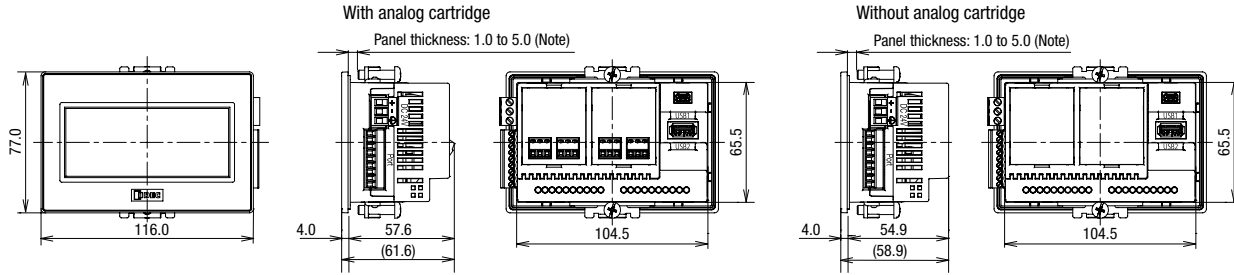

Note: Waterproof characteristic may not be obtained depending on the panel material and size.

When using rear mount adapter (FT9Z-1A01)

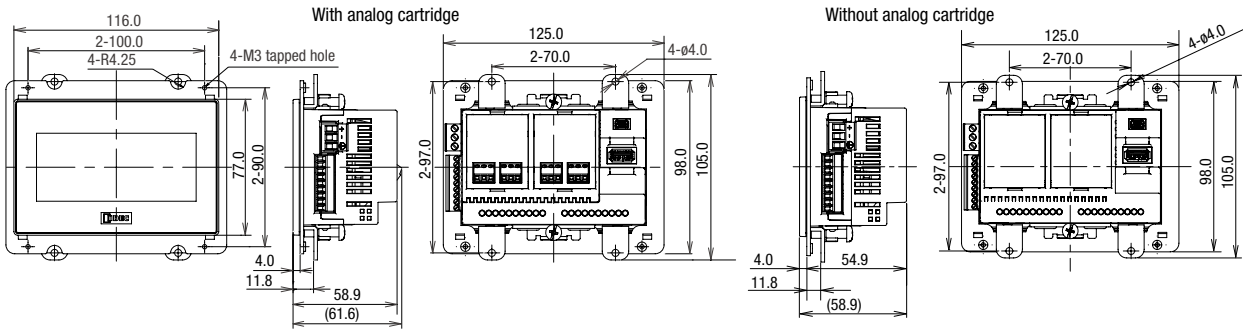

Pro (LCD Model)

Lite (No LCD Model)

FT1A-H12\*A/\*C

FT1A-H24\*A/\*C

FT1A-B12\*A/\*C

FT1A-B24\*A/\*C

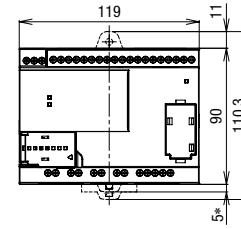
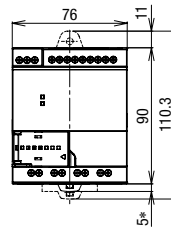
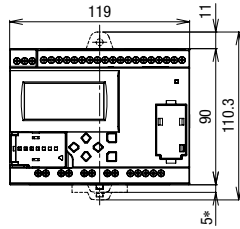
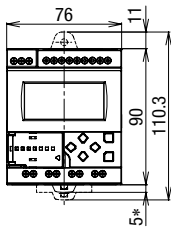

FT1A-H\*\*A

FT1A-H\*\*C

FT1A-B\*\*A

FT1A-B\*\*C

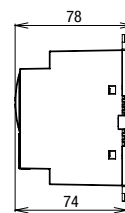
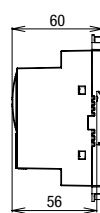
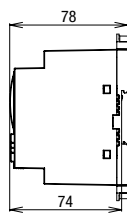
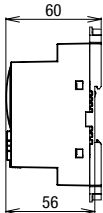

Note: 9.3 mm when the clamp is pulled out.

- APEM
- Switches & Pilot Lights
- Control Boxes
- Emergency Stop Switches
- Enabling Switches
- Safety Products
- Explosion Proof
- Terminal Blocks
- Relays & Sockets
- Circuit Protectors
- Power Supplies
- LED Illumination
- Controllers
- Operator Interfaces
- Sensors
- AUTO-ID

FC6A

FT1A

FL1F

All dimensions in mm.



# FT1A Controllers

## Terminal Arrangement and I/O Wiring Diagram Examples

For terminal arrangement and I/O wiring diagram, see Instruction Sheet.

### Touch (Display Model)

#### FT1A-\*12RA-\*

 : Fuse     : Load

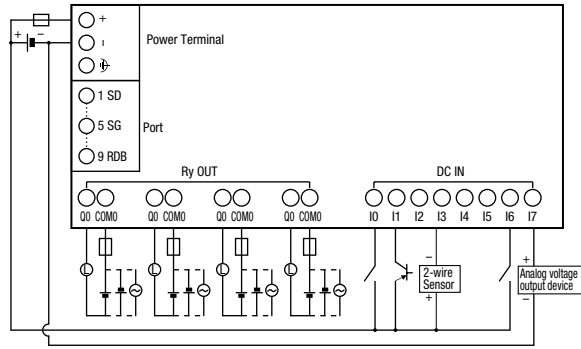

#### FT1A-\*14KA-\*

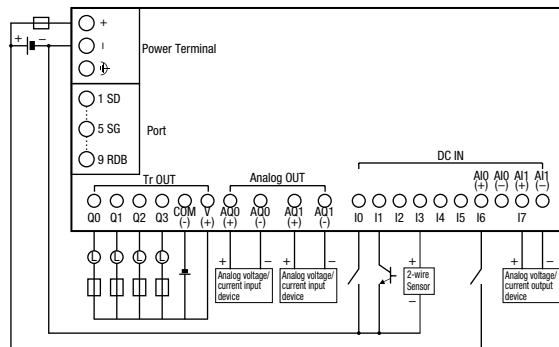

#### FT1A-\*14SA-\*

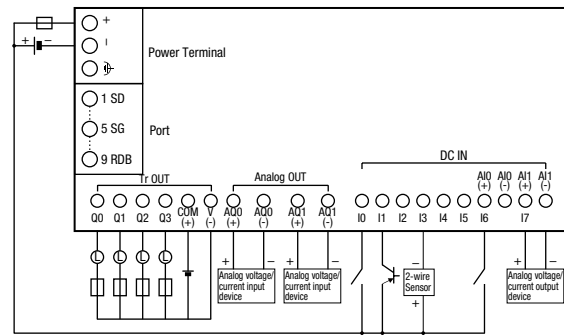

### Pro/Lite (LCD/No LCD Models)

#### FT1A-\*12RA

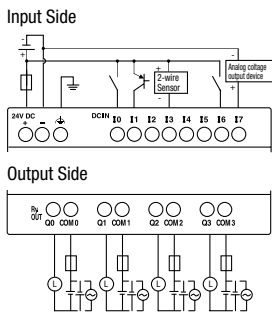

#### FT1A-\*12RC

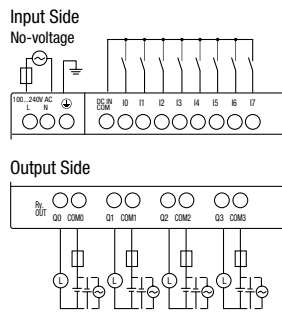

External power for input cannot be used.

#### FT1A-\*24RA

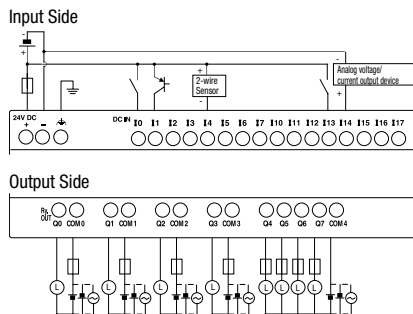

#### FT1A-\*24RC

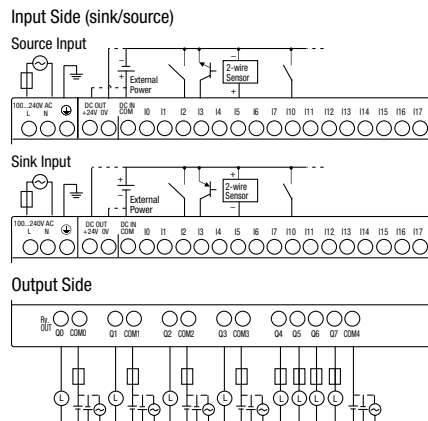

### Recommended Ferrules for Touch/Pro/Lite Terminals

Touch (LCD Model), Pro/Lite (LCD/No Models)

(All dimensions in mm)

Type	Cross Section (mm <sup>2</sup> )	AWG	Phoenix Contact Part No.	Ordering No.	Package Quantity	Touch				Pro/Lite		FC6A Cartridge	L1	L2	d1	S1	d2	d3	S2	
						Power Supply	Serial Interface	I/O		Power Supply	I/O									
								Relay Output Model	Transistor Output Model											
1-wire connection	0.25	24	AI 0.25-6 BU	3203040	100	—	—	—	—	—	—	×	10.5	6.0	0.8	0.15	1.8	—	0.25	
	0.34	22	AI 0.34-6 TQ	3203053	100	—	—	—	—	—	—	×	10.5	6.0	0.8	0.15	1.8	—	0.25	
			AI 0.34-8 TQ	3203066	100	×	×	×	×	—	—	—	—	12.5	8.0	0.8	0.15	2.0	—	0.25
	0.5	20	AI 0.5-6 WH	3200687	100	—	—	—	—	—	—	×	12.0	6.0	1.1	0.15	2.5	—	0.3	
			AI 0.5-8 WH	3200014	100	×	×	×	×	×	—	—	—	14.0	8.0	1.1	0.15	2.5	—	0.25
	0.75	18	AI 0.75-8 GY	3200519	100	×	—	—	—	—	—	—	—	14.0	8.0	1.3	0.15	2.8	—	0.25
			AI 1-8 RD	3200030	100	×	—	—	—	—	—	—	—	14.0	8.0	1.5	0.15	3.0	—	0.3
	1.0	16	AI 1-10 RD	3200182	100	—	—	—	—	—	—	—	—	16.0	10.0	1.5	0.15	3.0	—	0.3
			AI 1.5-8 BK	3200043	100	×	—	—	—	—	×	—	—	14.0	8.0	1.8	0.15	3.4	—	0.3
	1.5	16	AI 1.5-10 BK	3200195	100	—	—	—	—	—	—	—	—	18.0	10.0	1.8	0.15	3.4	—	0.3
AI-TWIN2×0.5-8 WH			3200933	100	×	×	—	—	×	—	—	—	15.0	8.0	1.5	0.15	2.5	4.6	0.25	
2-wire connection	0.5	20	AI-TWIN2×0.75-8 GY	3200807	100	×	—	—	—	×	—	—	15.0	8.0	1.8	0.15	2.8	5.2	0.25	
	0.75	18	AI-TWIN2×0.75-10 GY	3200975	100	—	—	—	—	—	—	—	17.0	10.0	1.8	0.15	2.8	5.2	0.25	
Screwdriver			SZS 0.6×3.5	1205053	10	×	—	—	—	×	—	—								
			SZS 0.4×2.5	1205037	10	—	×	—	—	×	—	—								

Note: Crimping pliers - Phoenix Contact part number CRIMPFOX 6 (1212034)

For 1-wire connection

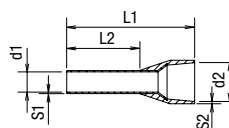

For 2-wire connection

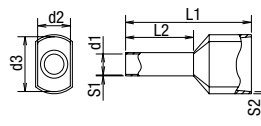

All dimensions in mm.

- APEM
- Switches & Pilot Lights
- Control Boxes
- Emergency Stop Switches
- Enabling Switches
- Safety Products
- Explosion Proof
- Terminal Blocks
- Relays & Sockets
- Circuit Protectors
- Power Supplies
- LED Illumination
- Controllers
- Operator Interfaces
- Sensors
- AUTO-ID
- FC6A
- FT1A
- FL1F



# FT1A Controllers

## Instructions

### Basic Instructions (Touch/Pro/Lite)

Instructions	Function
LOD	Stores intermediate results and reads contact status
LODN	Stores intermediate results and reads inverted contact status
AND	Series connection of NO contact
ANDN	Series connection of NC contact
OR	Parallel connection of NO contact
ORN	Parallel connection of NC contact
ANDL0D	Series connection of circuit blocks
ORL0D	Parallel connection of circuit blocks
BPS	Saves the result of bit logical operation temporarily
BRD	Reads the result of bit logical operation which was saved temporarily
BPP	Restores the result of bit logical operation which was saved temporarily
OUT	Outputs the result of bit logical operation
OUTN	Output the inverted result of bit logical operation
SET	Sets output, internal relay, or shift register bit
RST	Resets output, internal relay, or shift register bit
TMS	Subtracting 1-ms on-delay timer (0 to 65.535 sec)
TMH	Subtracting 10-ms on-delay timer (0 to 655.35 sec)
TIM	Subtracting 100-ms on-delay timer (0 to 6553.5 sec)
TML	Subtracting 1-sec on-delay timer (0 to 65535 sec)
TMSO	Subtracting 1-ms off-delay timer (0 to 65.535 sec)
TMHO	Subtracting 10-ms off-delay timer (0 to 655.35 sec)
TIMO	Subtracting 100-ms off-delay timer (0 to 6553.5 sec)
TMLO	Subtracting 1-sec off-delay timer (0 to 65535 sec)
CNT	Adding counter (0 to 65,535)
CNTD	Double-word adding counter (0 to 4,294,967,295)
CDP	Dual pulse reversible counter (0 to 65,535)
CDPD	Double-word dual pulse reversible counter (0 to 4,294,967,295)
CUD	Up/down selection reversible counter (0 to 65,535)
CUDD	Double-word up/down selection reversible counter (0 to 4,294,967,295)
CC=	Equal to comparison of counter current value
CC≥	Greater than or equal to comparison of counter current value
DC=	Equal to comparison of data register value
DC≥	Greater than or equal to comparison of data register value
SFR	Forward shift register
SFRN	Reverse shift register
SOTU	Rising-edge differentiation output
SOTD	Falling-edge differentiation output
JMP	Jumps a designated program area
JEND	Ends a jump instruction
MCS	Starts a master control
MCR	Ends a master control
END	Ends a program

### Advanced Instructions (Touch/Pro/Lite continued)

Instructions	Name
RAD	Degree to Radian
DEG	Radian to Degree
SIN	Sine
COS	Cosine
TAN	Tangent
ASIN	Arc Sine
ACOS	Arc Cosine
ATAN	Arc Tangent
LOGE	Natural Logarithm
LOG10	Common Logarithm
EXP	Exponent
POW	Power
ANDW	AND Word
ORW	OR Word
XORW	Exclusive OR Word
SFTL	Shift Left
SFTR	Shift Right
BCDLS	BCD Left Shift
WSFT	Word Shift
ROTL	Rotate Left
ROTR	Rotate Right
HTOB	Hex to BCD
BTOH	BCD to Hex
HTOA	Hex to ASCII
ATOH	ASCII to Hex
BTOA	BCD to ASCII
ATOB	ASCII to BCD
ENCO	Encode
DECO	Decode
BCNT	Bit Count
ALT	Alternate Output
CVDT	Convert Data Type
DTDV	Data Divide
DTCB	Data Combine
SWAP	Data Swap
TXDn (Note 1)	Transmit
RXDn (Note 1)	Receive
ETXDn (Note 1)	Transmit over Ethernet
ERXDn (Note 1)	Receive over Ethernet
LABEL	Label
LJMP	Label Jump
LCAL	Label Call
LRET	Label Return
DJNZ	Decrement Jump Non-zero
MSG (Note 2)	Message
IOREF	I/O Refresh
HSCRF (Note 3)	High-speed Counter Refresh
WEEK	Week Timer
YEAR	Yearly Timer
TADD	Time Addition
TSUB	Time Subtraction
HOURL	Hour Meter
HTOS	HMS to Sec
STOH	Sec to HMS
DTML	1-sec Dual Timer
DTIM	100-ms Dual Timer
DTMH	10-ms Dual Timer
DTMS	1-ms Dual Timer
TTIM	Teaching Timer
PULSn (Note 4)	Pulse Output
PWMn (Note 4)	Pulse Width Modulation
RAMPn (Note 4)	Ramp Pulse Output
ZRNn (Note 4)	Zero Return
ARAMPn (Note 4)	Advanced Ramp
DI	Disable Interrupt
EI	Enable Interrupt
XYFS	XY Format Set
CVXY	Convert X to Y
CVYX	Convert Y to X
PID (Note 5)	Perform PID control
AVRG	Average
FIFO	FIFO Format
FIEX	First-In Execute
FOEX	First-Out Execute
NDSRC	N Data Search
SCRPT	Script
DLOG (Note 6)	Data Logging
TRACE (Note 6)	Data Trace

### Advanced Instructions (Touch/Pro/Lite)

Instructions	Name
NOP	No Operation
MOV	Move
MOVN	Move Not
IMOV	Indirect Move
IMOVN	Indirect Move Not
IBMV	Indirect Bit Move
IBMVN	Indirect Bit Move Not
BMOV	Block Move
NSET	N Data Set
NRS	N Data Repeat Set
XCHG	Exchange
TCCST	Timer/Counter Current Value Store
CMP=	Compare Equal To
CMP<>	Compare Unequal To
CMP<	Compare Less Than
CMP>	Compare Greater Than
CMP<=	Compare Less Than or Equal To
CMP>=	Compare Greater Than or Equal To
ICMP>=	Interval Compare Greater Than or Equal to
LC=	Load Compare Equal To
LC<>	Load Compare Unequal To
LC<	Load Compare Less Than
LC>	Load Compare Greater Than
LC<=	Load Compare Less Than or Equal To
LC>=	Load Compare Greater Than or Equal To
ADD	Addition
SUB	Subtraction
MUL	Multiplication
DIV	Division
INC	Increment
ADD	Addition
SUB	Subtraction
MUL	Multiplication
DIV	Division
INC	Increment
DEC	Decrement
ROOT	Root
SUM	Sum

Note 1: Pro/Lite 24-I/O type only

Note 2: Pro only

Note 3: Touch, Pro/Lite DC power type only

Note 4: Pro/Lite 40-I/O DC type and 48-I/O AC/DC type only

Note 5: Touch transistor output model only (FT1A-\*14SA/FT1A-\*14KA)

Note 6: Pro/Lite 40-I/O, 48-I/O only

Function Blocks

Type	Symbol	Name and Diagram	Function
Input	I	Digital Input 	Inputs ON/OFF information from an external to the SmartAXIS.
	SM	Special Internal Relay 	Special internal relays can be used as bit inputs for FBs in the SmartAXIS. Special function is allocated to each special internal relay.
	R	Shift Register 	Outputs ON/OFF state of a shift register device.
	AI	Analog Input 	The analog input values (0 to 10V DC) for the analog input terminals are converted to digital values (0 to 1,000) and output. With the analog input linear conversion function, the analog input value can be linearly conversion within a range of -32,768 to 32,767.
Output	Q	Digital Output 	Outputs ON/OFF information from the SmartAXIS to an external device.
	M	Internal Relay 	A bit unit FB used internally by the SmartAXIS.
Logical Operation	AND	Logical AND 	Implements logical AND for a maximum of four input signals (ON/OFF) and outputs the result.
	NAND	Negative Logical AND 	Implements negative logical AND for a maximum of four input signals (ON/OFF) and outputs the result.
	OR	Logical OR 	Implements logical OR for a maximum of four input signals (ON/ OFF) and outputs the result.
	NOR	Negative Logical OR 	Implements negative logical OR for a maximum of four input signals (ON/OFF) and outputs the result.
	XOR	Exclusive Logical OR 	Implements exclusive logical OR for a maximum of two input signals (ON/OFF) and outputs the result.
	NXOR	Negative Exclusive Logical OR 	Implements negative exclusive logical OR for a maximum of two input signals (ON/OFF) and outputs the result.
	NOT	Negation 	Outputs the result of negating the input signal (ON/OFF).
	SOTU	Shot up 	Turns on the output for one scan when the input signal turns from off to on.
	SOTD	Shot down 	Turns on the output for one scan when the input signal turns from on to off.
	TRUTH	Truth Table 	A truth table for the output can be configured corresponding to the 16 patterns combination of the four input signals, and TRUTH FB outputs the result according to the table.
Timer	TIMU	On-delay Count Up Timer 	After the execution input turns on, the output turns on when the on-delay time elapses. The current value is incremented from zero to the preset value.
	TIMD	On-delay Count Down Timer 	After the execution input turns on, the output turns on when the on-delay time elapses. The current value is decremented from the preset value to zero.
	TIMOU	Off-delay Count Up Timer 	When the execution input turns on, the output turns on. After the execution input turns off, the output turns off when the off-delay time elapses. The current value is incremented from zero to the preset value.
	TIMOD	Off-delay Count Down Timer 	When the execution input turns on, the output turns on. After the execution input turns off, the output turns off when the off-delay time elapses. The current value is decremented from the preset values to zero.
	TIMCU	On/off-delay Timer 	After the execution input turns on, the output turns on when the on-delay time elapses. After the execution input turns off, the output turns off when the off-delay time elapses.
	SPULS	Single Shot Pulse 	After the execution input turns on, the output turns on for the configured time period.
	DTIM	Dual Timer 	The output is turned on and off according to the configured ON and OFF time.
	RPULS	Random Pulse Output 	The output is turned on for the length of random time within the configured range of time.

- APEM
- Switches & Pilot Lights
- Control Boxes
- Emergency Stop Switches
- Enabling Switches
- Safety Products
- Explosion Proof
- Terminal Blocks
- Relays & Sockets
- Circuit Protectors
- Power Supplies
- LED Illumination
- Controllers
- Operator Interfaces
- Sensors
- AUTO-ID

FC6A

FT1A

FL1F

# FT1A Controllers

Counter	CNT		When the clock input is turned on, the current value is incremented by one. The output turns on when the current value reaches the preset value.
	CUD		When the clock input is turned on, the current value is incremented or decremented by one according to the up/down selection input. The current value is compared with ON/OFF thresholds. The output turns on or off according to the comparison result.
	HOUR		Accumulates the ON duration of the execution input in hours, minutes, and seconds. The output turns on when the accumulated time reaches the configured time.
Shift Register	SFR		When the execution input turns on, the shift registers are shifted to the specified shift direction.
Data Comparison	CMP		Two inputs values are compared and the output turns on or off according to the comparison result.
	STTG		The comparison input value and the ON/OFF thresholds are compared and the output turns on or off according to the comparison result.
	RCMP		The comparison input value and the upper/lower limits are compared and the output turns on or off according to the comparison result.
Data Conversion	ALT		Sets/resets the output.
Week Programmer	WEEK		Compares the specified day of the week, ON time, and OFF time with the current time and outputs the result.
	YEAR		Compares the specified date with the current date and outputs the result.
Interface (Note 1)	MSG		Displays data such as text and device values on the LCD on the SmartAXIS Pro.
Pulse (Note 2)	PULS		Outputs pulses at the specified frequency.
	PWM		Outputs pulses at the specified frequency and duty cycle.
	RAMP		Outputs pulses with the frequency change function.
	ZRN		Outputs pulses with the different pulse frequency corresponding to the on/off state of a deceleration signal.
	ARAMP		Output pulses with the frequency change function according to the settings configured in the frequency table.
Data Logging (Note 3)	DLOG		Saves the values of the specified devices in the specified data format as a CSV file to the SD memory card.
	TRACE		Saves the values of the previous number of scans for the specified device in the specified data format as a CSV file to the SD memory card.
Script	SCRPT		Enables you to program complicated processing with the script language that supports conditional branching, logical operations, arithmetic operations, and functions.
Special	HSC		Operates the high-speed counter configured in the function area settings. Turns on/off the high-speed counter gate input/reset input/clear input.
	RSFF		When the set input turns on, the output turns on and keeps on. When the reset input turns on, the output turns off.

Note 1: Pro only

Note 2: Pro/Lite 40-I/O DC type and 48-I/O AC/DC type only

Note 3: Pro/Lite 40-I/O, 48-I/O only

Note 4: Touch, Pro/Lite DC power type only

Scripts

Type	Format	Description
Control statements	if	if ((Cond. expr.)) { (Exe. line.);}
	if else	if ((Cond. expr.)) { (Exe. line1.);} else{ (Exe. line2.);}
	if else if else	if ((Cond. expr1.)) { (Exe. line1.);} else if ((Cond. expr2.)) { (Exe. line2.);} else{ (Exe. line3.);}
	switch case default	switch (Cond. expr.) {case constant 1: (Cond. expr1.);break; case constant2: (Cond. expr2.); break; default: (Cond. expr3.);break;}
	while	while ((Cond. expr.)) { (Exe. line.);}
	break	break;
return	return;	
Relational operator	==, !=, <, >, <=, >=	Two values are compared.
Logical operator	&&,   , !	Logical operation of two values (AND, OR, NOT).
Arithmetic operator	+, -, *, /, %, =	Addition, subtraction, multiplication, division, remainder, assignment
Bit operator	&,  , ^, ~, <<, >>	Logical product (AND), logical sum (OR), exclusive logical sum (XOR), reverse, shift left, shift right
Bit function	Bit set	SET ( [a] );
	Bit reset	RST ( [a] );
	Bit reverse	REV ( [a] );
Arithmetic operation	Maximum value	MAX( [a], [b], [c] )
	Minimum value	MIN ( [a], [b], [c] )
	Exponential function	EXP ( [a] )
	Natural logarithm	LOGE ( [a] )
	Common logarithm	LOG10 ( [a] )
	Exponentiation	POW ( [a], [b] )
	Square root	ROOT ( [a] )
	Sine	SIN ( [a] )
	Cosine	COS ( [a] )
	Tangent	TAN ( [a] )
	Arcsine	ASIN ( [a] )
	Arccosine	ACOS ( [a] )
	Arctangent	ATAN ( [a] );
	Conversion from angle to radian	RAD ( [a] );
	Conversion from radian to angle	DEG ( [a] );
Data type conversion	Conversion from BCD to Binary	BCD2BIN ( [a] )
	Conversion from binary to BCD	BIN2BCD ( [a] )
	Conversion from float32 to binary	FLOAT2BIN ( [a] )
	Conversion from binary to float32	BIN2FLOAT ( [a] )
	Conversion from decimal to string character	DEC2ASCII ( [a], [b] )
	Conversion from string character to decimal	ASCII2DEC ( [a] )
	Data comparison and copy	MEMCMP ( [a], [b], [c] )
Character string operation	Data copy	MEMCPY ( [a], [b], [c] )
	Character string copy	STRCUT ( [a], [b], [c], [d] )
	Character number count	STRLEN ( [a] )
	Character string concatenation	STRCAT ( [a], [b] )
Draw (Note 1)	Character string search	STRSTR ( [a], [b] )
	Drawing of straight line	LINE ( [a], [b], [c], [d] )
	Drawing of rectangle	RECTANGLE ( [a], [b], [c], [d] )
Offset	Drawing of circle and ellipse	CIRCLE ( [a], [b], [c], [d] )
	Indirect specification	OFFSET ( [a], [b] )
Bit device ↔ word device Cross Operator Functions (Note 2)	Bit device (1 word length) to bit device (1 word length)	BITS2BITS ( [a], [b] )
	Bit device (1 word length) to Word device	BITS2WORD ( [a], [b] )
	Word device to bit device (1 word length)	WORD2BITS ( [a], [b] )

Note 1: Touch (WindO/I-NV3) only

Note 2: Pro/Lite (WindLDR)

- APEM
- Switches & Pilot Lights
- Control Boxes
- Emergency Stop Switches
- Enabling Switches
- Safety Products
- Explosion Proof
- Terminal Blocks
- Relays & Sockets
- Circuit Protectors
- Power Supplies
- LED Illumination
- Controllers
- Operator Interfaces
- Sensors
- AUTO-ID
- FC6A
- FT1A
- FL1F

# Ordering Terms and Conditions

Thank you for using IDEC Products.

By purchasing products listed in our catalogs, datasheets, and the like (hereinafter referred to as "Catalogs") you agree to be bound by these terms and conditions. Please read and agree to the terms and conditions before placing your order.

## 1. Notes on contents of Catalogs

- (1) Rated values, performance values, and specification values of IDEC products listed in this Catalog are values acquired under respective conditions in independent testing, and do not guarantee values gained in combined conditions.  
Also, durability varies depending on the usage environment and usage conditions.
- (2) Reference data and reference values listed in Catalogs are for reference purposes only, and do not guarantee that the product will always operate appropriately in that range.
- (3) The specifications / appearance and accessories of IDEC products listed in Catalogs are subject to change or termination of sales without notice, for improvement or other reasons.
- (4) The content of Catalogs is subject to change without notice.

## 2. Note on applications

- (1) If using IDEC products in combination with other products, confirm the applicable laws / regulations and standards.  
Also, confirm that IDEC products are compatible with your systems, machines, devices, and the like by using under the actual conditions. IDEC shall bear no liability whatsoever regarding the compatibility with IDEC products.
- (2) The usage examples and application examples listed in Catalogs are for reference purposes only. Therefore, when introducing a product, confirm the performance and safety of the instruments, devices, and the like before use. Furthermore, regarding these examples, IDEC does not grant license to use IDEC products to you, and IDEC offers no warranties regarding the ownership of intellectual property rights or non-infringement upon the intellectual property rights of third parties.
- (3) When using IDEC products, be cautious when implementing the following.
  - i. Use of IDEC products with sufficient allowance for rating and performance
  - ii. Safety design, including redundant design and malfunction prevention design that prevents other danger and damage even in the event that an IDEC product fails
  - iii. Wiring and installation that ensures the IDEC product used in your system, machine, device, or the like can perform and function according to its specifications
- (4) Continuing to use an IDEC product even after the performance has deteriorated can result in abnormal heat, smoke, fires, and the like due to insulation deterioration or the like. Perform periodic maintenance for IDEC products and the systems, machines, devices, and the like in which they are used.
- (5) IDEC products are developed and manufactured as general-purpose products for general industrial products. They are not intended for use in the following applications, and in the event that you use an IDEC product for these applications, unless otherwise agreed upon between you and IDEC, IDEC shall provide no guarantees whatsoever regarding IDEC products.
  - i. Use in applications that require a high degree of safety, including nuclear power control equipment, transportation equipment (railroads / airplanes / ships / vehicles / vehicle instruments, etc.), equipment for use in outer space, elevating equipment, medical instruments, safety devices, or any other equipment, instruments, or the like that could endanger life or human health
  - ii. Use in applications that require a high degree of reliability, such as provision systems for gas / waterworks / electricity, etc., systems that operate continuously for 24 hours, and settlement systems
  - iii. Use in applications where the product may be handled or used deviating from the specifications or conditions / environment listed in the Catalogs, such as equipment used outdoors or applications in environments subject to chemical pollution or electromagnetic interference  
If you would like to use IDEC products in the above applications, be sure to consult with an IDEC sales representative.

## 3. Inspections

We ask that you implement inspections for IDEC products you purchase without delay, as well as thoroughly keep in mind management/maintenance regarding handling of the product before and during the inspection.

## 4. Warranty

- (1) Warranty period  
The warranty period for IDEC products shall be one (1) year after purchase or delivery to the specified location. However, this shall not apply in cases where there is a different specification in the Catalogs or there is another agreement in place between you and IDEC.
- (2) Warranty scope  
Should a failure occur in an IDEC product during the above warranty period for reasons attributable to IDEC, then IDEC shall replace or repair that product, free of charge, at the purchase location / delivery location of the product, or an IDEC service base. However, failures caused by the following reasons shall be deemed outside the scope of this warranty.
  - i. The product was handled or used deviating from the conditions / environment listed in the Catalogs
  - ii. The failure was caused by reasons other than an IDEC product
  - iii. Modification or repair was performed by a party other than IDEC
  - iv. The failure was caused by a software program of a party other than IDEC
  - v. The product was used outside of its original purpose
  - vi. Replacement of maintenance parts, installation of accessories, or the like was not performed properly in accordance with the user's manual and Catalogs
  - vii. The failure could not have been predicted with the scientific and technical standards at the time when the product was shipped from IDEC
  - viii. The failure was due to other causes not attributable to IDEC (including cases of force majeure such as natural disasters and other disasters)Furthermore, the warranty described here refers to a warranty on the IDEC product as a unit, and damages induced by the failure of an IDEC product are excluded from this warranty.

## 5. Limitation of liability

The warranty listed in this Agreement is the full and complete warranty for IDEC products, and IDEC shall bear no liability whatsoever regarding special damages, indirect damages, incidental damages, or passive damages that occurred due to an IDEC product.

## 6. Service scope

The prices of IDEC products do not include the cost of services, such as dispatching technicians. Therefore, separate fees are required in the following cases.

- (1) Instructions for installation / adjustment and accompaniment at test operation (including creating application software and testing operation, etc.)
- (2) Maintenance inspections, adjustments, and repairs
- (3) Technical instructions and technical training
- (4) Product tests or inspections specified by you

The above content assumes transactions and usage within your region. Please consult with an IDEC sales representative regarding transactions and usage outside of your region. Also, IDEC provides no guarantees whatsoever regarding IDEC products sold outside your region.

# IDEC CORPORATION

**Head Office** 6-64, Nishi-Miyahara-2-Chome, Yodogawa-ku, Osaka 532-0004, Japan

**USA** IDEC Corporation  
**EMEA** APEM SAS

**Singapore** IDEC Izumi Asia Pte. Ltd.  
**Thailand** IDEC Asia (Thailand) Co., Ltd.  
**India** IDEC Controls India Private Ltd.

**China** IDEC (Shanghai) Corporation  
IDEC Izumi (H.K.) Co., Ltd.  
**Taiwan** IDEC Taiwan Corporation

**Japan** IDEC Corporation

 [www.idec.com](http://www.idec.com)

Specifications and other descriptions in this brochure are subject to change without notice.

2024 IDEC Corporation, All Rights Reserved.

