



WB1F Fix Linear CCD Scanner

User's Manual



Introduction

Attention

- IDEC Corporation holds all rights related to this manual. Unauthorized duplication, reproduction, sales, transfers, or leasing without the express consent of IDEC is prohibited.
- The content of this manual may change without prior notification.
- We have taken all possible measures with the content of this product, but if you notice any portions that are unclear, or any mistakes, please contact the dealer where purchased or an IDEC sales representative.

Applicable standards

The applicable standards that this product supports are listed below.

- IEC/EN 60950-1 (2005)
- IEC/EN 61000-6-1 (2007)
- IEC 62471 (2006)
- IEC 61000-6-3 (2006)
- EN 61000-6-3 (2007)
- EN 55022 (2010) Class B
- EN 55024 (2010)
- UL 60950-1, 2nd Edition, 2011-12-19
- FCC Part 15 Subpart B Class B (Verification)
- CSA C22.2 No.60950-1
- ICES-003 Class B (self-declared)
- VCCI Class B (compliance confirmed)

FCC Regulations

This device complies with Part 15 of the FCC Rules. Operation is subject to the following two conditions:

- (1) This device may not cause harmful interference, and
- (2) this device must accept any interference received, including interference that may cause undesired operation.

NOTE: This equipment has been tested and found to comply with the limits for a Class B digital device, pursuant to Part 15 of the FCC Rules. These limits are designed to provide reasonable protection against harmful interference in a residential installation. This equipment generates, uses and can radiate radio frequency energy and, if not installed and used in accordance with the instructions, may cause harmful interference to radio communications. However, there is no guarantee that interference will not occur in a particular installation. If this equipment does cause harmful interference to radio or television reception, which can be determined by turning the equipment off and on, the user is encouraged to try to correct the interference by one or more of the following measures;

- Reorient or relocate the receiving antenna.
- Increase the separation between the equipment and receiver.
- Connect the equipment into an outlet on a circuit different from that to which the receiver is connected.
- Consult the dealer or an experienced radio/TV technician for help.

Canadian Department of Communications Compliance Statement

- CAN ICES-3(B) / NMB-3(B)

For details on the applicable standards, please inquire with the distributor where purchased.

Version up information

New function has been added to WB1F. Please check the applicable models and the main application version of firmware before using. Method for version acquisition refers to [P. 5-7 "No.39 Get version" of "Control commands list"](#). In addition, the initial release version is "A-002.000.00".

The firmware of WB1F is available on the IDEC website.

You can use WB1F Support Tool to upgrade the version of firmware. About the method of version upgrade, please check the user's manual of WB1F Support Tool (WB1F-SOFT-SUPPORT-TOOL-MANUAL-E, B-1767).

New Function	Main application version	
	RS-232 type	USB type
	WB1F-100S1B	WB1F-100S1S
PLC Connection function*1	A-002.010.00	–
Menu Sheet support	A-002.010.00	
External trigger input filter time		
Reading start when power on		
No response when reading failed		
GS1-128 2016 year edition Compliant AI	A-002.020.00	
RS-232 Setting Communication speed Addition of 600bps		
High speed upload and download supported	A-002.030.00	
GS1-128 2017 year edition Compliant AI	A-002.040.00	
GS1-128 2018 year edition Compliant AI	A-002.050.00	
Number of decoding times addition	A-002.060.00	
GS1-128 2019 year edition Compliant AI		

*1 USB type does not support PLC connection function.

General terms, abbreviations, and terminology used in this manual





The general terms, abbreviations, and terminology used in this manual are as follows.

Item	Details
WB1F	An abbreviation for the WB1F-100S1B and the WB1F-100S1S.
RS-232 type	The type that uses RS-232 for the communication interface. (The cable end must be fabricated.) (WB1F-100S1B)
USB type	The type that uses USB for the communication interface. (WB1F-100S1S)
Communication interface	Refers to the RS-232 interface and the USB interface.
Prevention time of same read	The wait time to prevent reading the same barcode twice when reading barcodes consecutively.
Number of characters	Refers to the total number of 1-byte codes that are sent and received from the RS-232 interface and the USB interface.
AIM ID	An abbreviation for AIM-compliant symbology identification ID.
AI	An abbreviation for Application Identifier which GS1 standardized.
Pitch	Refers to the rotation angle of the barcode symbols for the axis parallel to the bar height. For details, refer to P. 5-3 "5. 2. 2 Angular characteristics" .
Skew	Refers to the rotation angle of the barcode symbols for the axis parallel to the barcode symbol length. For details, refer to P. 5-3 "5. 2. 2 Angular characteristics" .
Tilt	Refers to the rotation angle of the barcode symbols for the axis perpendicular to the barcode symbol. For details, refer to P. 5-3 "5. 2. 2 Angular characteristics" .
Light receiving axis	The axis that provides the image of the reflected light from the barcode to the WB1F internal CCD.
Reading timeout	The time after a reading request turns on until reading is automatically turned off. This time is applied when a factor does not occur that is supposed to turn reading off such as reading succeeded, external trigger input off, and the stop reading command.
Receive buffer	A storage area that temporarily stores received data.
Send buffer	A storage area that temporarily stores send data.
Quiet zone	The margins to the left and right of the barcode.
Control characters	ASCII codes 00H to 1FH and 7FH. In this manual, they are expressed using <input type="checkbox"/> . For details, refer to P. 5-11 "5. 7 ASCII code table" .
Prefix	Character data that is added to the beginning of output data and communication commands.
Suffix	Character data that is added to the end of output data and communication commands.
Output	Output is the general term for communication output, OK output, NG output, PWM output, and the indicator LED.
Input	Input is the general term for the Operation button, external trigger input, and communication input.
IDEC website	www.idec.com









Graphic symbols used in this manual

The following graphic symbols are used in this manual to simplify the explanations.

Notes

Graphic symbol	Meaning
 Warning	Warning notices are used to emphasize that improper operation may cause severe personal injury or death.
 Caution	Caution notices are used where inattention might cause personal injury or damage to equipment.
	Information that requires special attention. Failure to operate the product in accordance with the information provided can lead to serious injury or damage.
	Useful information relating to a function.

Product series name

Graphic symbol	Meaning
 RS-232 Type	This symbol () indicates functions that can be used with the RS-232 type, and the other symbol () indicates functions that cannot be used.
 RS-232 Type	
 USB Type	This symbol () indicates functions that can be used with the USB type, and the other symbol () indicates functions that cannot be used.
 USB Type	

Examples

Symbols for the product series names are listed in this manual as follows.

 **RS-232 Type**  **USB Type** : Can be used with all product series.

 **RS-232 Type**  **USB Type** : Can be used with the RS-232 type. Cannot be used with USB type.

 **RS-232 Type**  **USB Type** : Can be used with the USB type. Cannot be used with RS-232 type.

SAFETY PRECAUTIONS

- Before installing and wiring this product, operating it, or performing maintenance and inspection, please read this manual carefully and use the product correctly.
- The degree of possible danger that may occur if the product is mishandled is classified as "Warning" and "Caution". The meaning of each is as follows.



Warning

Warning notices are used to emphasize that improper operation may cause severe personal injury or death.



Caution

Caution notices are used where inattention might cause personal injury or damage to equipment.

Safety precautions



Warning

- This product is not designed for use in medical equipment, nuclear power, railways, aircraft, passenger vehicle equipment, or similar applications requiring a high degree of reliability and safety. Do not use the product for these applications.
- When using this product in a system that may impact human life, such as in the management of chemicals, take the utmost care with a redundant design and safety design so that there is no possibility of impacting human life when data is mistaken.
- Do not modify, disassemble, or repair this product. There is a risk of serious accidents such as electric shock, damage, fire, malfunction, and other heave accident.
- When using this product in situations where it is not built into other equipment, do not use an integrated power supply. Otherwise there is a risk of fire or electric shock.
- Do not directly look at the reading window (red transparent section) or expose any person to it while the LED is illuminated (performing reading operation). There is a risk of danger to the eyes.
- This product is for general electronic equipment. Do not use it for applications where there is a direct threat to the body or to human life due to malfunction or failure.
- Always turn off the power supply before wiring, maintaining, and inspecting the product. Otherwise there is a risk of electric shock or failure.

Caution

- Do not connect the product to a power supply outside the rated power supply voltage range or to an AC power supply. Otherwise there is a risk of explosion or burnout.
- Mistakenly wiring the product may cause the internal circuit to be damaged. Wire the input and output circuits by referring to the connection examples in [P. 2-5 "2. 3. 1 Wiring the RS-232 type"](#). This product is not equipped with a protection circuit for a reversed power supply connection, so there is a risk of damage when the power supply connection is reversed. Use extreme caution when connecting the power supply.
- Avoid parallel wiring of the product's wires in the same conduit or duct with high voltage lines or power lines (inverter power lines in particular) as this may cause malfunction or damage due to the effect of induction noise.
- If the wires are long and when there is a risk of being affected by power sources or solenoids, independently wire the product as a general rule.
- Avoid installing or using the product in the following locations as there is a risk of malfunction or damage.
 - Near induction equipment or heat sources
 - Locations with many vibrations or shocks
 - Dusty and dirty locations
 - In an atmosphere with hazardous gases such as sulfidizing gas
 - Locations in direct contact with water, oils, or chemicals
 - Outdoors
- This product is not an explosion-proof product. Confirm that explosion-proof capabilities are not required when installing the product.

Precautions for Use

Caution

- Use the product in the environment listed in the catalog and manual. If this product is used in locations with high temperatures, high humidity, condensation, corrosive gas, or excessive vibration/shock, there is a risk of electric shock, fire, and malfunction.
- The usage environment pollution degree for this product is "pollution degree 2". Use the product in a pollution degree 2 environment. (Based on the IEC 60664-1 standard)



- The power supply reset time is 300 ms, so perform operations 300 ms after turning the power on.
- At initial startup, perform operations 10 s after turning the power on.
- When the load and the unit are connected to different power supplies, always turn on the unit's power supply first.
- Install the product so that the reading window is not directly exposed to sunlight or fluorescent light.
- The non-volatile memory equipped on WB1F can be overwritten 100,000 times.

Cleaning

● Cleaning the reading window

If dust, dirt, or water drops get on the reading window or if it gets scratched, this will affect barcode reading performance.

Periodically inspect the reading window to see if there is anything on it, and when you find something, clean it off.

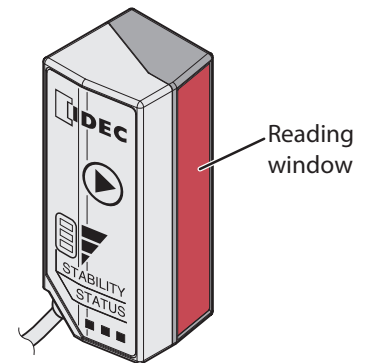

Cleaning methods

- To clean the reading window, blow off dust/dirt with an airbrush, and then gently wipe it off with a soft-tipped item such as a cotton swab.
- If there are water drops on the reading window, wipe them off with a soft cloth.
- Always turn off the power supply before cleaning the product.



PMMA is used for the reading window material, so do not use organic solvents (such as alcohol, thinner, or benzene), ammonia, or sodium hydroxide. Otherwise this may change the properties of the reading window.

● Cleaning the unit

- Please wipe the dust off a body of the WB1F with a soft, dry cloth.
- When that body is very dirty, please wipe it with a cloth soaked in a neutral detergent diluted with water and wrung out thoroughly, and then wipe it with a soft, dry cloth.



Do not use organic solvents such as alcohol, thinner, or benzene. This may alter the case or strip the paint.

Related manuals

Manuals related to the WB1F are as follows. Please refer to them together with this manual.

Type	Manual name	Details
B-1775	WB1F Fix Linear CCD Scanner User's Manual (this manual)	Explains an overview and functions of the WB1F, plus basic operating methods.
B-1741	Instruction Sheet WB1F series	Included with the product.
B-1768	WB1F Fix Linear CCD Scanner Support Tool User's Manual	Included with the support tool. Explains about support tool.
B-1782	WB1F Fix Linear CCD Scanner Menu Sheet	Explains about menu sheet.

Contents

Introduction.....	i
Attention	i
Applicable standards	i
Version up information	ii
General terms, abbreviations, and terminology used in this manual.....	iii
Graphic symbols used in this manual.....	iv
Notes.....	iv
Product series name.....	iv
SAFETY PRECAUTIONS	v
Safety precautions	v
Precautions for Use.....	vi
Cleaning.....	vii
Related manuals.....	viii
Contents.....	ix

1 Overview **1-1**

1.1	Checking the packaged product and the product configuration.....	1-1
1.2	Part names and functions	1-2
1.3	System configuration	1-3

2 Installation & wiring **2-1**

2.1	Installation precautions	2-1
2.2	Mounting methods	2-3
2.2.1	WB1F mounting methods	2-3
2.2.2	Setup barcode position	2-4
2.3	Wiring	2-5
2.3.1	Wiring the RS-232 type.....	2-5
2.3.2	Wiring the USB type.....	2-8

3 Function 3-1

3.1	Overview	3-1
3.1.1	Operation mode.....	3-1
3.1.2	Operation mode switching operation and status.....	3-2
3.2	Slave mode	3-3
3.2.1	Switching operation to slave mode.....	3-3
3.2.2	Barcode reading.....	3-4
3.2.3	Output data additional information.....	3-11
3.2.4	Output data editing.....	3-16
3.2.5	Comparison-Matching.....	3-18
3.2.6	Analysis.....	3-23
3.2.7	Command alias.....	3-24
3.2.8	Communication command.....	3-26
3.3	Setup support mode.....	3-29
3.3.1	Switching operation to setup support mode (setup support function)	3-29
3.3.2	Setup support function.....	3-31
3.4	Maintenance mode	3-33
3.4.1	Switching operation to maintenance mode.....	3-33
3.4.2	Maintenance support.....	3-35
3.4.3	Firmware updating.....	3-35
3.5	Configuration item table	3-36

4 Support tool 4-1

4.1	Overview	4-1
-----	----------------	-----

5 Appendix 5-1

5.1	Product specifications.....	5-1
5.2	Field of view/characteristics.....	5-2
5.2.1	Field of view.....	5-2
5.2.2	Angular characteristics	5-3
5.3	Dimensional outline drawings	5-4
5.4	Troubleshooting.....	5-5
5.5	Control commands list.....	5-6
5.6	Check digit calculation method.....	5-10

5.7	ASCII code table.....	5-11
5.8	AIM symbology ID table	5-13
5.9	GS1-128 Application Identifier.....	5-15
5.10	Configuration barcode.....	5-16
5.11	Sample labels.....	5-17
5.12	Installing the USB driver (USB type)	5-19
5.13	Setting check digit.....	5-20
5.14	Setting margin rate	5-23
5.15	Index	5-25
	Revision history	A-1

1 Overview

This chapter describes the product configuration of the WB1F, the names and functions of its parts, and the basic system configuration during operation.

1.1 Checking the packaged product and the product configuration

RS-232 Type USB Type

The WB1F is packaged with the following items.

Before using the WB1F, please check that the unit and accessories are present and that they have suffered no damage.

Unit: 1

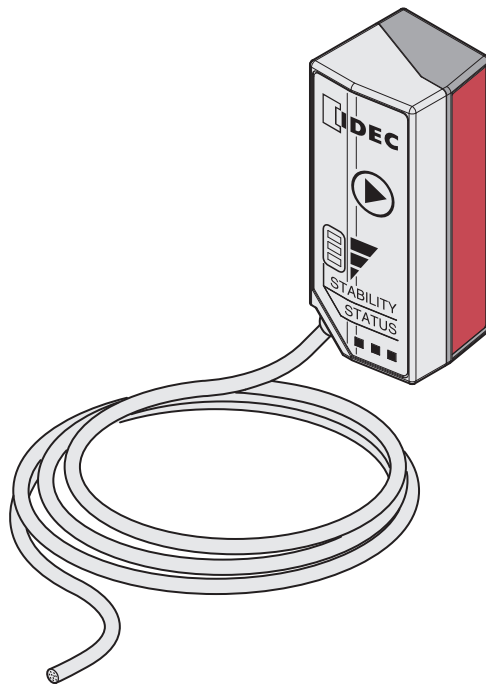

*The illustration is the WB1F-100S1B.

Product mounting screws (M3): 2 Instruction Manual: 1

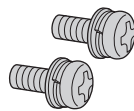

1.2 Part names and functions

RS-232 Type

USB Type

This section describes the names and functions of WB1F parts.

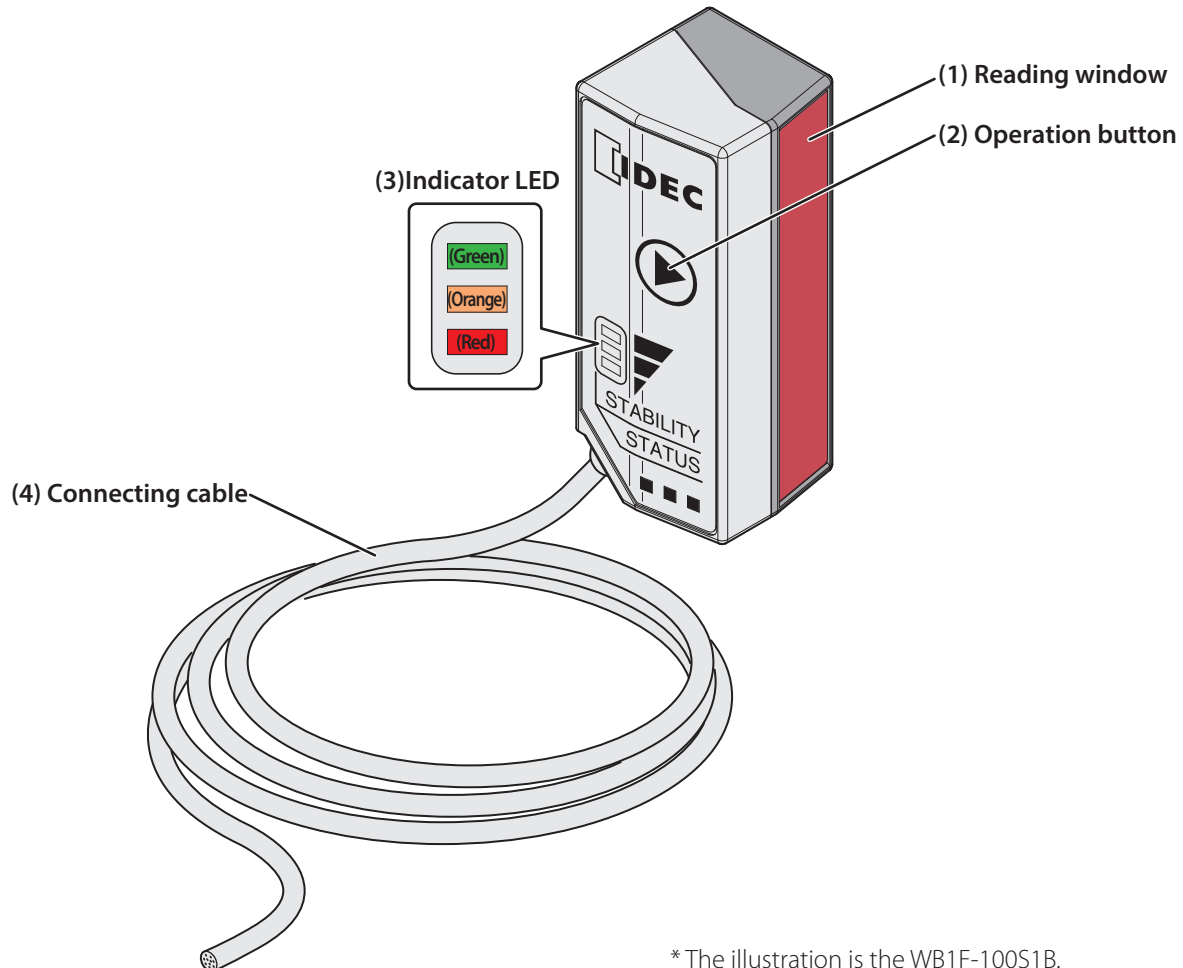

* The illustration is the WB1F-100S1B.

No.	Name	Function
(1)	Reading window	The unit reads barcodes through the reading window. While the unit is reading barcodes, the internal emitter LED turns on.
(2)	Operation button	Use the operation button to turn on the barcode reading request and to switch the operation mode.
(3)	Indicator LED	The indicator LED indicates the operating status of the unit. (Green): Turns on when reading has succeeded and the read image is matched on comparison. (Orange) : Turns on during a reading operation. (Red): Turns on when reading fails and the read image is not matched on comparison. This operation may differ due to the settings. The status of the indicator LEDs also changes due to the unit's operating status.
(4)	Connecting cable	RS-232 type <ul style="list-style-type: none"> • This type communicates via the RS-232 interface. • Performs control of OK output, NG output, and PWM output. • Judges the external trigger input status and turns the reading request on and off. • Connect to the power supply (5V DC). USB type <ul style="list-style-type: none"> • This type communicates via the USB interface (USB virtual COM).

1.3 System configuration

The basic system configuration when operating the WB1F is as follows.

RS-232 type

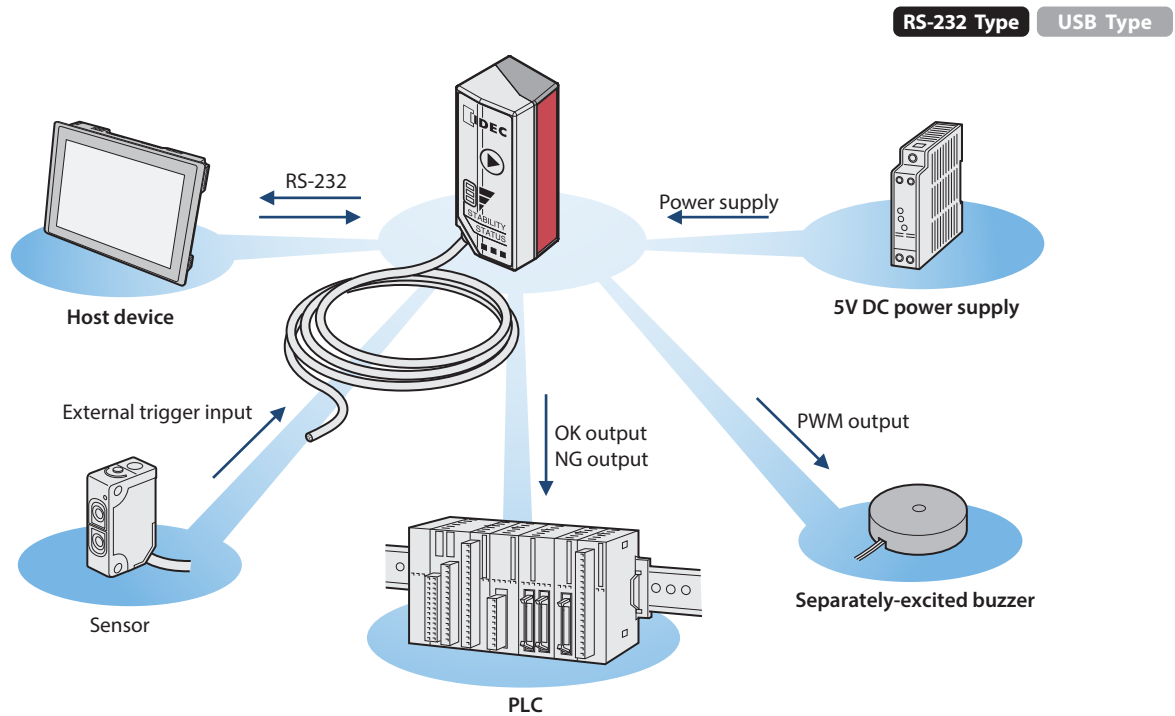

USB type

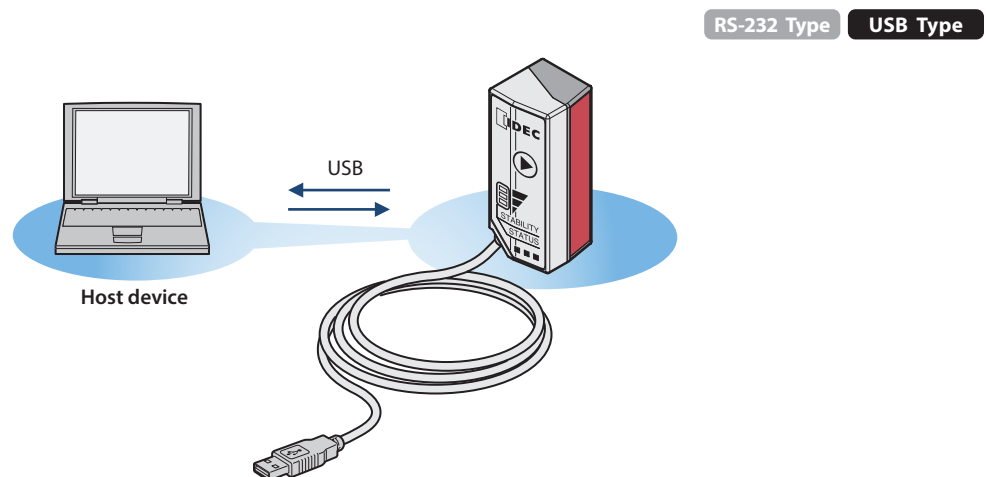

When connecting a computer, refer to [P. 5-19](#) "5. 11 Installing the USB driver (USB type)".

2 Installation & wiring

This chapter describes WB1F installation locations, mounting methods, and wiring the WB1F to peripheral devices.

2.1 Installation precautions

RS-232 Type USB Type

- Install the unit so that ambient light such as sunlight, fluorescent light, and photoelectric switches does not enter the reading window.

Otherwise the unit may not be able to read barcodes or it may erroneously read them.

Example Take measures to block ambient light or to change the position of photoelectric switches.

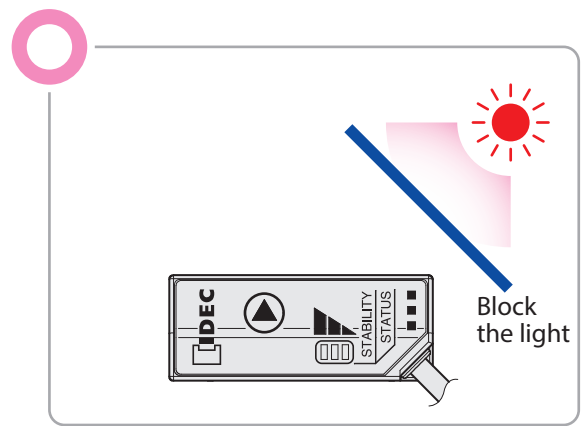
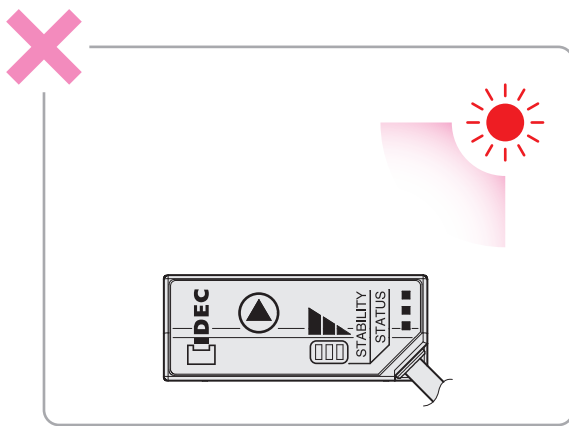

- Do not install a reflective body (metal or mirror) along the light receiving axis.
- Otherwise the unit may not be able to read barcodes or it may erroneously read them.

Example Prevent reflections by applying black tape to the reflective body.

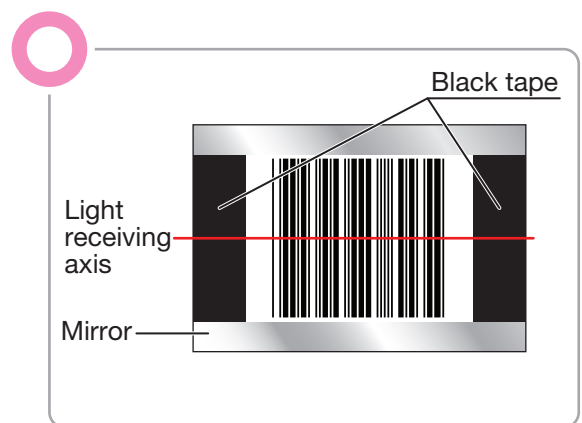
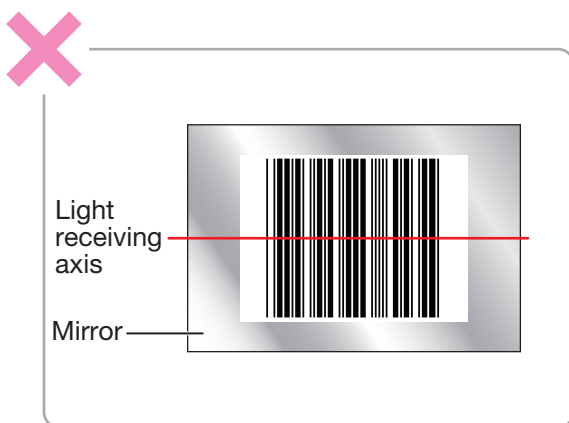

For the light receiving axis, refer to [P. 2-4 "2. 2. 2 Setup barcode position"](#).

- When installing WB1F units in a series, install them so the emitted LED light does not overlap (so they do not interfere with each other).

Otherwise the unit may not be able to read barcodes or it may erroneously read them.

Example Install the WB1F units by increasing the spacing between them.

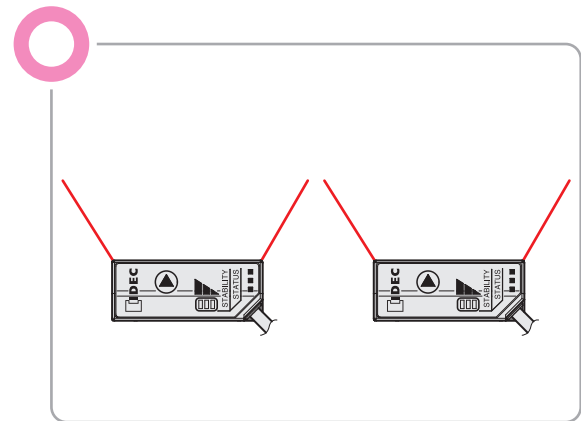
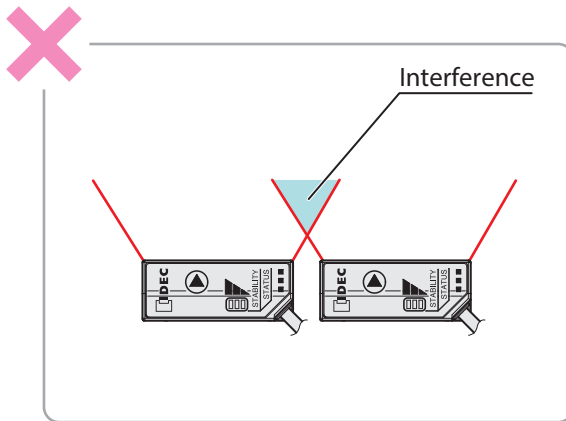

- Install the WB1F so that two or more barcodes do not enter the reading area. The WB1F cannot simultaneously read multiple barcodes.

Example Use the WB1F by increasing the spacing between barcodes.

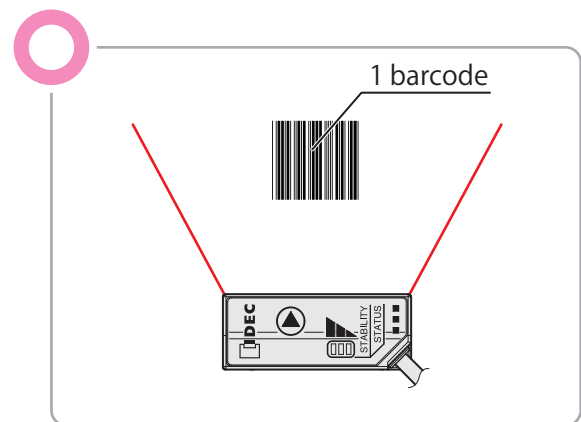
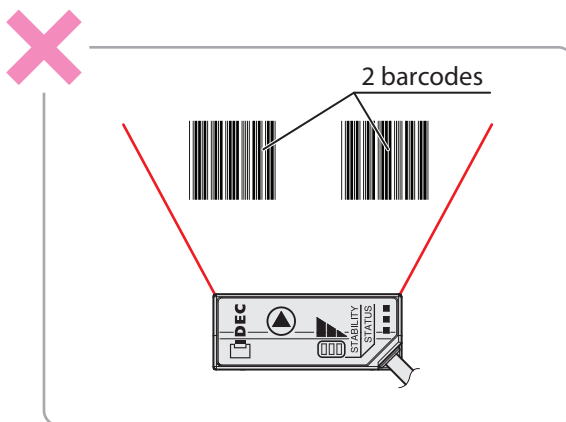

2.2 Mounting methods

RS-232 Type

USB Type

2.2.1 WB1F mounting methods

1 Check the dimensions of the mounting holes and drill holes in the mounting plate.

For the dimensions of the mounting holes, refer to [P. 5-4 "5.3 Dimensional outline drawings"](#).

2 For a plate thickness of 0.8 to 2.3 mm, use the two included product mounting screws and secure the WB1F to the plate.

The tightening torque for the product mounting screws is 0.4 to 0.5 N·m.

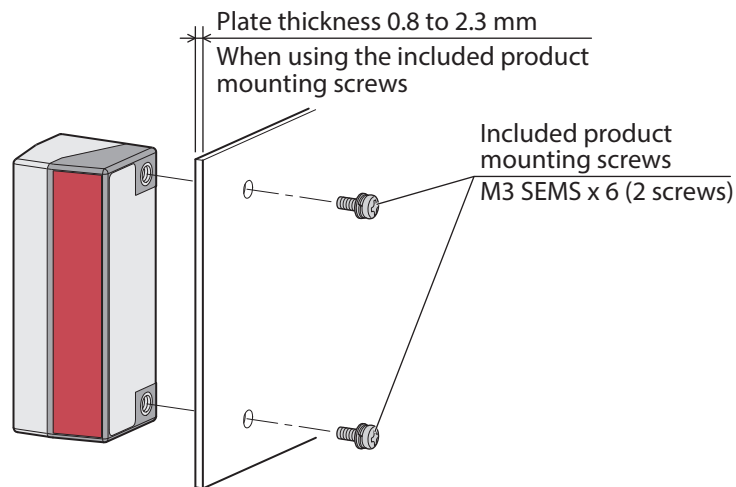

- For a plate thickness other than 0.8 to 2.3 mm, do not use the included product mounting screws. Instead, use two M3 screws with an effective thread length of 3 to 5 mm and secure the WB1F to the plate.
- When using the WB1F, remove the protective film on the reading window.



- For a plate thickness other than 0.8 to 2.3 mm, do not use the included product mounting screws.
- Do not over tighten the mounting screws or hit the product with a hammer or the protective construction will be damaged.

2.2.2 Setup barcode position

Install the unit so that barcode skew θ is in the range of $-20^\circ \leq \theta \leq 0^\circ$ and $+20^\circ \leq \theta \leq +40^\circ$.

For the reading area, refer to [P. 5-2 "5. 2. 1 Field of view"](#). For other angular characteristics, refer to [P. 5-3 "5. 2. 2 Angular characteristics"](#). For detailed dimensions, refer to [P. 5-4 "5. 3 Dimensional outline drawings"](#).

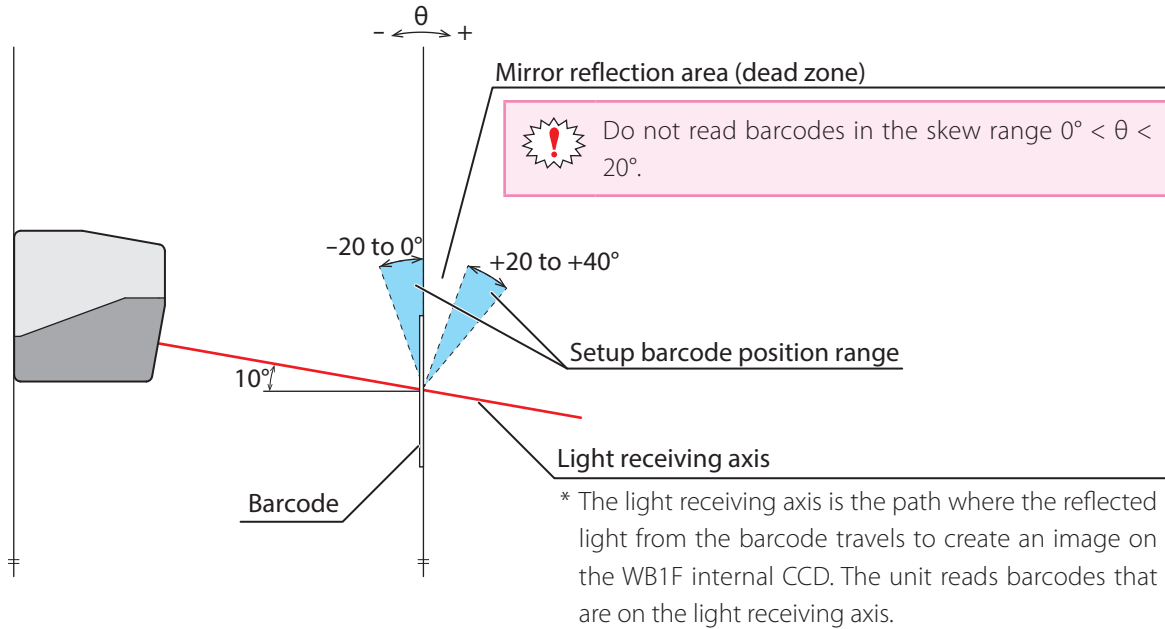

- Skew in a range of $0^\circ < \theta < 20^\circ$ is in the mirror reflection area (dead zone), so reading performance may drastically decrease in ways such as the unit not being able to read or misreading barcodes.
- Install the unit so the light receiving axis is in the center of the barcode.
- The unit may not be able to read barcodes that are short in height as they will not be in the light receiving axis. Ensure that the barcode height is 3 mm or higher.



[P. 3-31 "3. 3. 2 Setup support function"](#) to adjust the installation position while checking the barcode reading rate.

2.3 Wiring

2.3.1 Wiring the RS-232 type

RS-232 Type

USB Type

● Wire colors

The wires with the following colors are drawn out of the connecting cable.
Wire the cable according to the usage and application.

Conductor color	Signal name	Function
Black	0 V	Power supply- (combined SG)
Red	5V DC	Power supply+
Yellow	NG_O	NG output
Purple	OK_O	OK output
Blue	CTS	RS-232 control signal
Orange	RTS	RS-232 control signal
White	RXD	RS-232 receive data
Green	TXD	RS-232 transmission data
Gray	Ex_trig	External trigger input
Brown	PWM_O	PWM output



The shield wire is not connected inside the unit.
Connect it to FG or 0V depending on the ambient noise.

● Wiring the power supply

Connect the red conductor color (5V DC) to the positive side of the 5V DC power supply and connect black (0 V) to the negative side. Carefully read the following important notes and wire the unit using the following connection example as a reference.

WB1F

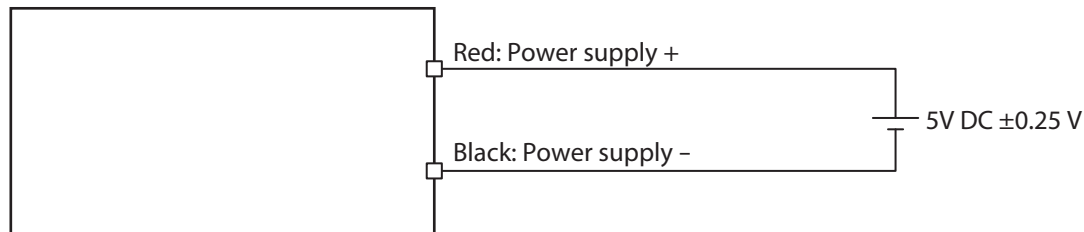

Caution

Do not reverse the power supply connections under any circumstances. Doing so may result in damage.



- Always turn off the WB1F's power supply before wiring the product.
- Use the product within the rated power supply voltage range. Otherwise there is a risk of explosion or burn-out.
- When using this product in situations where it is not built into other equipment, do not use an integrated power supply. Otherwise there is a risk of fire or electric shock.
- The power supply reset time is 300 ms. Use the product 300 ms or later after turning on the power supply.
- Avoid parallel wiring of the product's wires in the same conduit or duct with high voltage lines or power lines (inverter power lines in particular) as this may cause malfunction or damage due to the effect of induction noise.
- If the wires are long and when there is a risk of being affected by power sources or solenoids, independently wire the product as a general rule.
- For the RS-232 type, extend the cable with a AWG30 or thicker cable with due consideration the drop in the power supply voltage.
If the total cable length exceeds 2.8 m, this may affect noise resistance, so fully evaluate this when using the product.
For the RS-232 type, connect a shield of cable to ground or 0V when the communication performance is not good by the noise environment.
- For USB type, do not extend the connecting cable. Doing so may result in malfunction or damage.

● Wiring external trigger input

The external trigger input is used to turn on the reading request.

The external trigger input operates as a non-voltage input or a voltage input (VIL: 1.0 V, VIH: 4.0 V-VCC).

Wire the I/O circuit by referring to the following I/O circuit connection example (dry contact).

WB1F

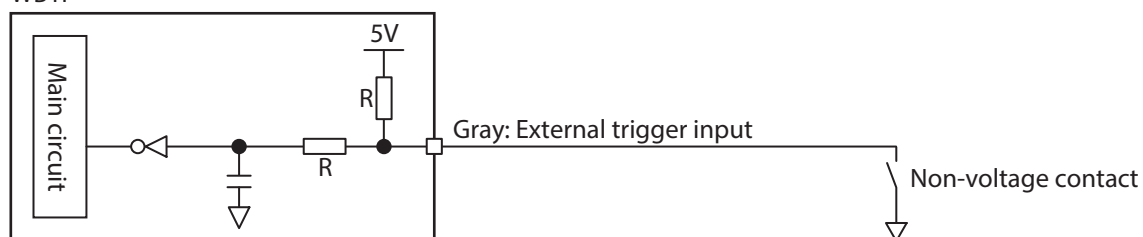

Caution

Mistakenly wiring the product may cause the internal circuit to be damaged.

● Wiring OK output, NG output, PWM output

The OK output and NG output are used for the reading success/failure judgment and matched/not matched judgment on reference data. The PWM output is used to sound an separately-excited buzzer.

The OK output, NG output, and PWM output are NPN open collector outputs.

Wire the I/O circuit by referring to the following I/O circuit connection example.

WB1F

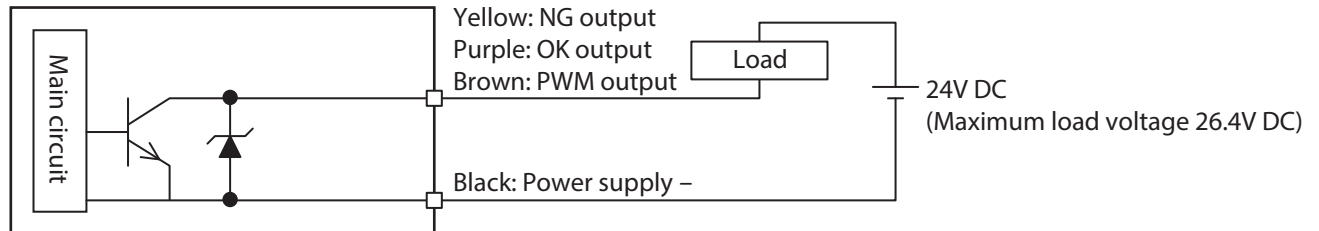

Caution

Mistakenly wiring the product may cause the internal circuit to be damaged.



When the load and the unit are connected to different power supplies, always turn on the unit's power supply first.

● RS-232 wiring

When connecting the unit to a host device such as an operator interface or a computer via RS-232, wire it referring to the following example.

Host device (computer)

Name	Pin number
RXD	2
TXD	3
CTS	8
RTS	7
GND	5
DCD	1
DTR	4
DSR	6
RI	9

D-sub 9-pin connector

WB1F

Wire color	Name
Green	TXD
White	RXD
Orange	RTS
Blue	CTS
Black	0V
Red	5VDC

5V DC

● RS-232 setting at the time of the factory shipment.

RS-232 setting at the time of the factory shipment becomes like a table.

RS-232 Setting	Setting Value
Communication Speed	9,600bps
Data length	8bit
Parity	EVEN
Stop bit	1bit
Flow control	NONE

2.3.2 Wiring the USB type

RS-232 Type

USB Type

● USB connector pin assignment

The connecting cable is a USB Type A (male) USB connector.

Pin number	Signal name	Function
1	VBUS	Power supply+ (bus power)
2	D-	Data-
3	D+	Data+
4	0V	Power supply-

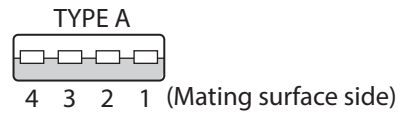

Do not extend the connecting cable. Doing so may result in malfunction or damage.

● Connecting the USB connector

When connecting the unit to a host device, firmly insert the USB connector straight into the USB port on the host device in the correct orientation.

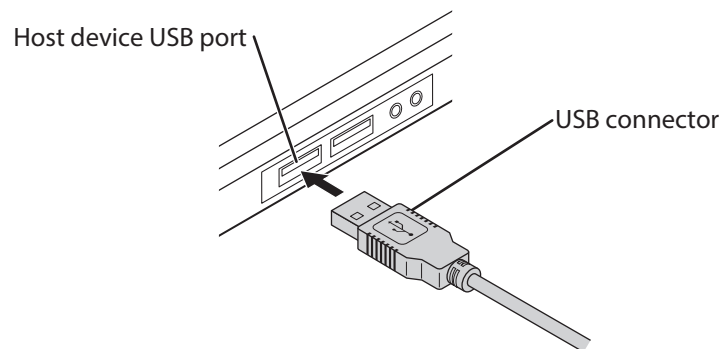

3 Function

This chapter describes the functions of the WB1F.

3.1 Overview

RS-232 Type USB Type







3.1.1 Operation mode

The functions that the WB1F can execute differ by the operation mode.

There are three operation modes: slave mode, setup support mode, and maintenance mode.

■ Slave mode

This mode is used during normal operation. Slave mode has the following functions.

Function	Details	Reference page
Barcode reading	This function reads a barcode and outputs the reading results.	 P. 3-4
Output data additional information	This function adds various types of data when outputting the barcode reading results data.	 P. 3-11
Output data editing	This function outputs the barcode reading results data after editing it according to the specified method.	 P. 3-16
Matching method	This function matches the barcode reading results data with the reference data, judges whether or not it is matched, and outputs that.	 P. 3-18
Analysis	This function is for analyzing the barcode quality and the WB1F status/installation environment.	 P. 3-23
Command alias	This function executes the control commands "start barcode reading" and "stop barcode reading" with other strings.	 P. 3-24
Communication command	This function sends and receives data with the connected host device via the WB1F communication interface.	 P. 3-26



■ Setup support mode

This mode is used to check the installation position and reading status of the WB1F. Setup support mode has the following function.

Function	Details	Reference page
Setup support function	This function checks whether or not a barcode can be correctly read during WB1F installation.	 P. 3-31

■ Maintenance mode

This mode is used to maintain the WB1F after installation and to perform actions when problems occur. Maintenance mode has the following functions.

Function	Details	Reference page
Maintenance support	This function forcibly operates the unit with the factory default settings.	 P. 3-35
Firmware updating	This function updates the WB1F firmware.	 P. 3-35

3.1.2 Operation mode switching operation and status

The operation mode is switched using the Operation button or communication commands.

For the communication commands, refer to [P. 3-26 "3. 2. 8 Communication command"](#).

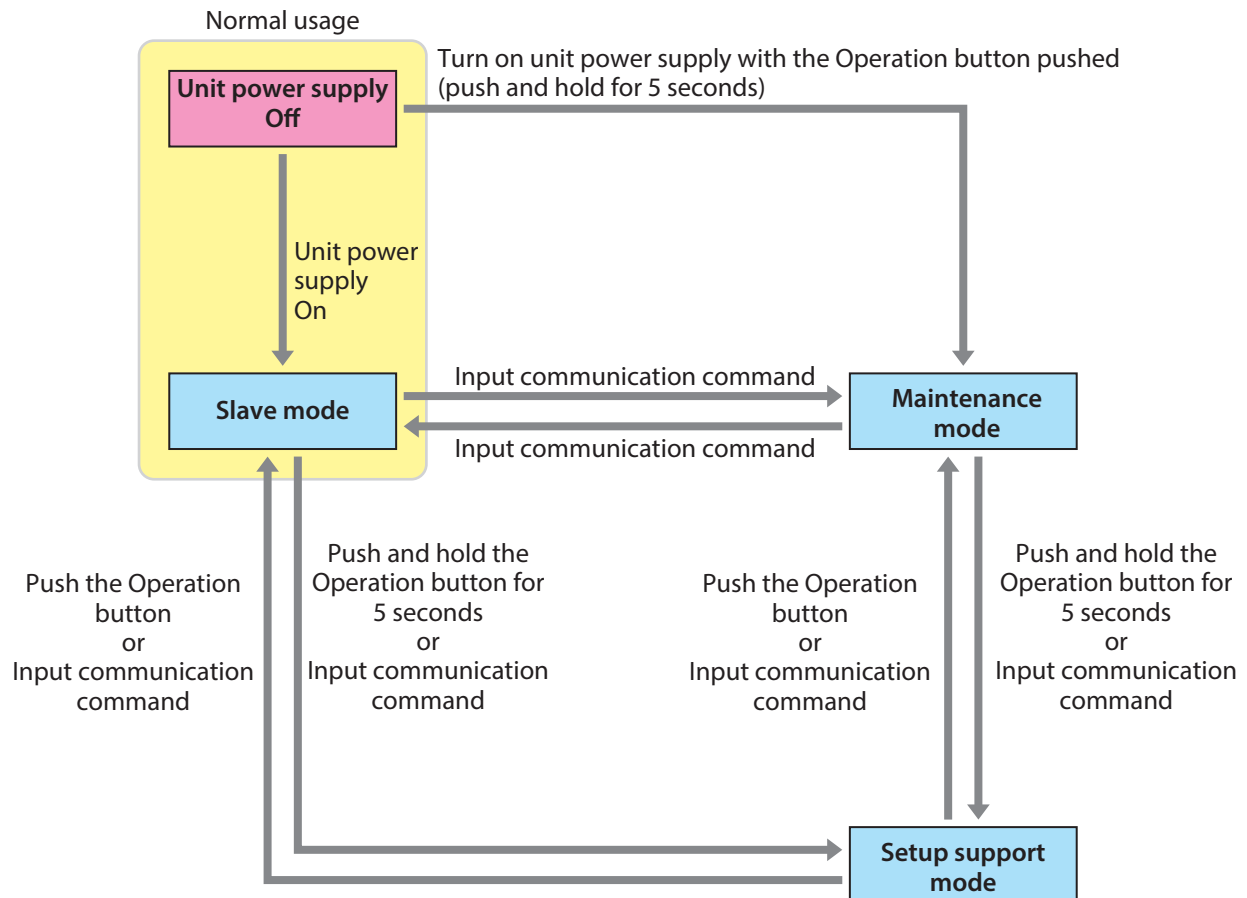

For details on the operation modes, refer to the following.

- Slave mode..... [P. 3-3](#)
- Setup support mode [P. 3-29](#)
- Maintenance mode..... [P. 3-33](#)







3.2 Slave mode

RS-232 Type

USB Type

This operation mode is used during normal operation. Use the unit in this mode after installation.

Slave mode has the following functions.

- Barcode reading  P. 3-4
- Output data additional information  P. 3-11
- Output data editing  P. 3-16
- Matching method  P. 3-18
- Analysis  P. 3-23
- Command alias  P. 3-24
- Communication command  P. 3-26

3.2.1 Switching operation to slave mode

There are two methods to switch to slave mode.

Use the methods according to the situation.

The indicator LEDs (red/orange/green) will turn off when switching to slave mode.

Method 1 Turn on the power to the unit. (Do not push the Operation button)

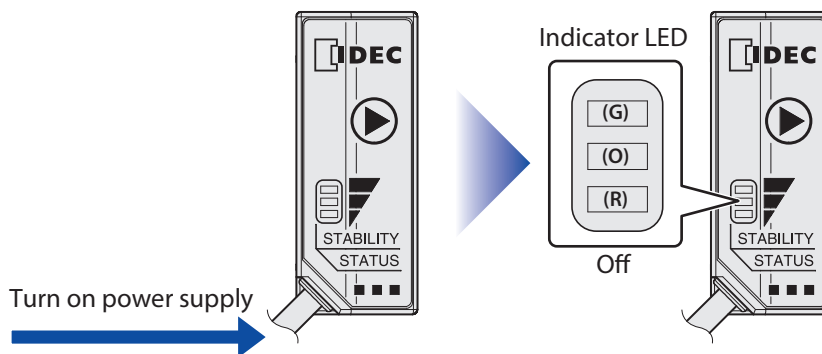

Method 2 Input the "switch to slave mode" control command.

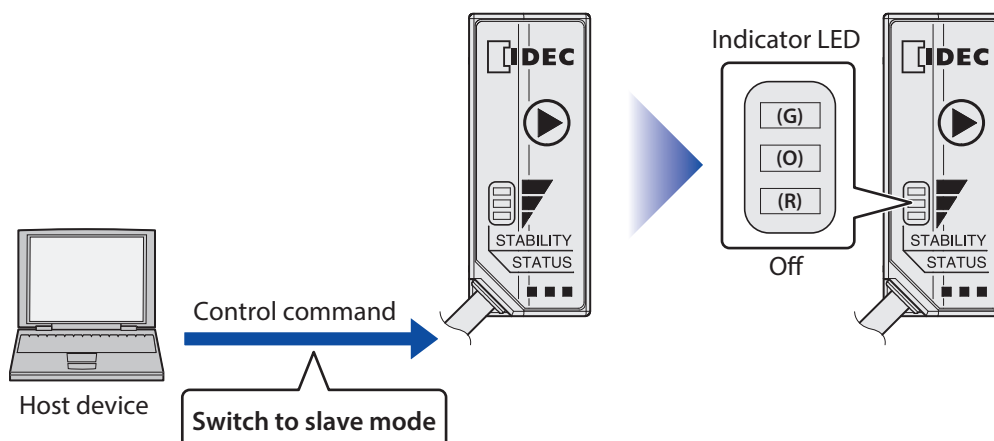

3.2.2 Barcode reading

The barcode reading reads a barcode and outputs the reading results.



For barcode reading settings, refer to "3.5 Configuration item table" - P. 3-39 "Barcode reading".

● Barcode reading methods

There are three methods to start reading (reading request on).

Method 1 Push the Operation button.

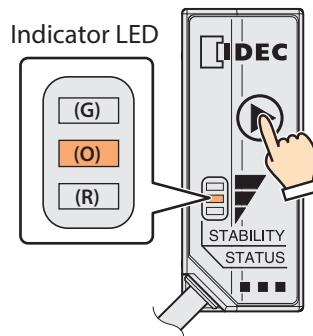

Method 2 Input the "start barcode reading" control command.

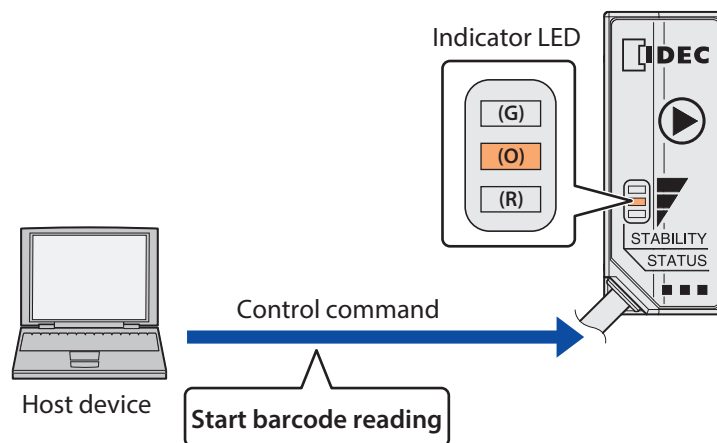

Method 3 Turn on the external trigger input.

RS-232 Type

USB Type

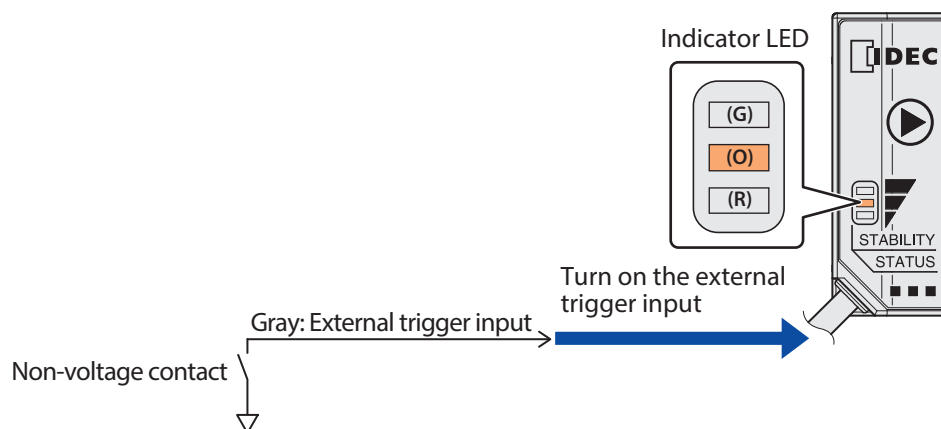







- Do not turn the reading request on and off using multiple methods.
- When using method 3, start barcode reading by turning on the reading request for 50 ms or longer. Stop barcode reading by turning off the reading request for 50 ms or longer.
- The reading results can be reflected in the indicator LEDs, OK output, NG output, PWM output, and communication interface.
- The indicator LED (orange) turns on during the reading operation. For linked control, the illumination pattern, and the illumination time, refer to "3.5 Configuration item table" -  P. 3-38 "Indicator LED settings".



● Reading operation

There are three types of reading operations.

- Single label read.....  P. 3-5
 - Edge-triggered.....  P. 3-6
 - Level-triggered.....  P. 3-7
- Multiple label read sequential output.....  P. 3-8
- Multiple label read collectively output.....  P. 3-9

Single label read

Single label read is where barcode reading is started by turning on the reading request, and when reading has completed, those results are output. Reading is performed once for one reading request. Single label read has two types of reading operations.

- Edge-triggered  P. 3-6
- Level-triggered  P. 3-7

■ Edge-triggered

Edge-triggered executes barcode reading after detecting the rising edge in the reading request (off on).

If the reading timeout time is set between 100 ms and 25,500 ms, single label read is edge-triggered. For details, refer to "3.5 Configuration item table" - [P. 3-39 "Barcode reading"](#).

When the reading request is turned on with the external trigger input, the stop condition is either of the following.

- Reading succeeded
- Reading timeout time elapsed

To control the reading request with the Operation button or control commands, refer to [P. 3-10 "Start conditions and stop conditions for reading requests"](#).

The following timing chart is an example of operation by the external trigger input.

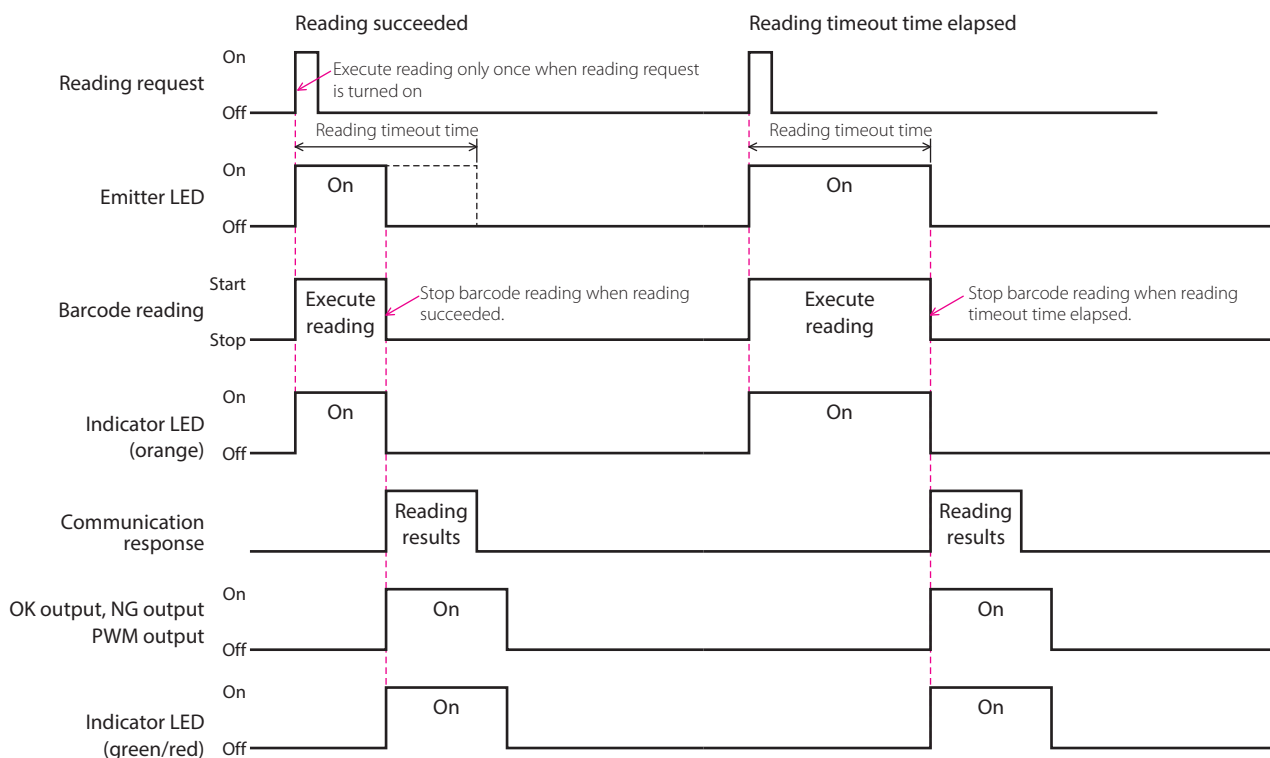

- The operation of the OK output, NG output, PWM output, and indicator LEDs varies depending on the settings.
- The indicator LED (orange) turns on when barcode reading starts if the reading linked control setting is enabled. It turns off when the set illumination time elapses or when barcode reading stops.
- The indicator LEDs (green/red) turn on when barcode reading stops if the reading linked control setting is enabled. They turn off when the set illumination time elapses or when barcode reading starts.
- If the reading linked control setting is enabled, reading success/failure or matched/not matched is judged when barcode reading stops, and the OK output, NG output, and PWM output are controlled according to the settings.

■ Level-triggered

When the reading request is turned on, barcode reading starts. The unit executes reading while the reading request is on. If the reading timeout time is set to infinity, barcode reading is level-triggered. For details, refer to "3.5 Configuration item table" - [P. 3-39 "Barcode reading"](#).

When the reading request is turned on with the external trigger input, the stop condition is either of the following.

- Reading succeeded
- External trigger input off (reading request off)

To control the reading request with control commands, refer to [P. 3-10 "Start conditions and stop conditions for reading requests"](#).

The following timing chart is an example of operation by the external trigger input.

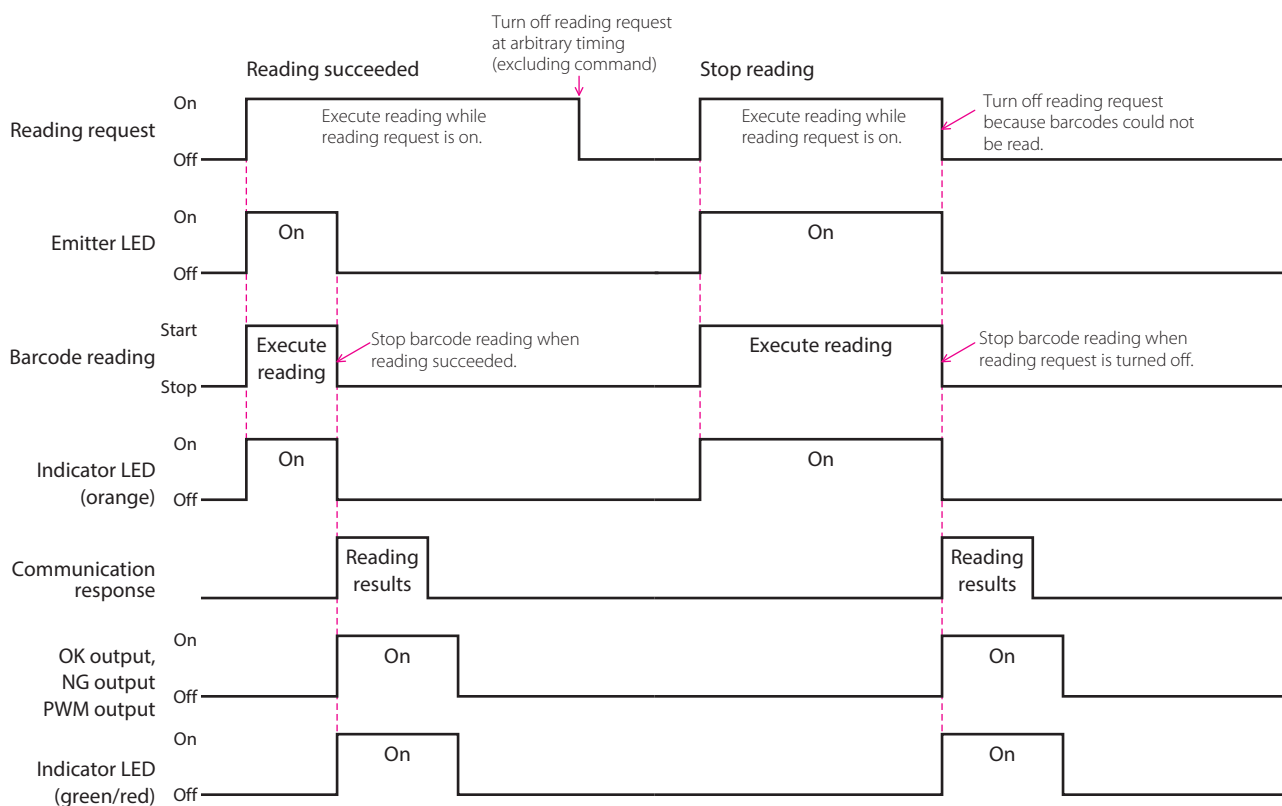

- The operation of the OK output, NG output, PWM output, and indicator LEDs varies depending on the settings.
- The indicator LED (orange) turns on when barcode reading starts if the reading linked control setting is enabled. It turns off when the set illumination time elapses or when barcode reading stops.
- The indicator LEDs (green/red) turn on when barcode reading stops if the reading linked control setting is enabled. They turn off when the set illumination time elapses or when barcode reading starts.
- If the reading linked control setting is enabled, reading success/failure or matched/not matched is judged when barcode reading stops, and the OK output, NG output, and PWM output are controlled according to the settings.

Multiple label read sequential output

Barcode reading starts when the reading request is turned on. While the request is on, reading continues and each time barcode reading has completed, those results are output.

The barcode operation stops when the reading request is turned off.

This becomes "edge-triggered" if the reading timeout time is set between 100 ms and 25,500 ms and "level-triggered" if set to infinity.

If the reading request is turned on with the external trigger input and level-triggered, the stop condition is the following.

- External trigger input off

To control the reading request with control commands, refer to [P. 3-10 "Start conditions and stop conditions for reading requests"](#).

The following timing chart is an example of operation by the external trigger input and level-triggered.

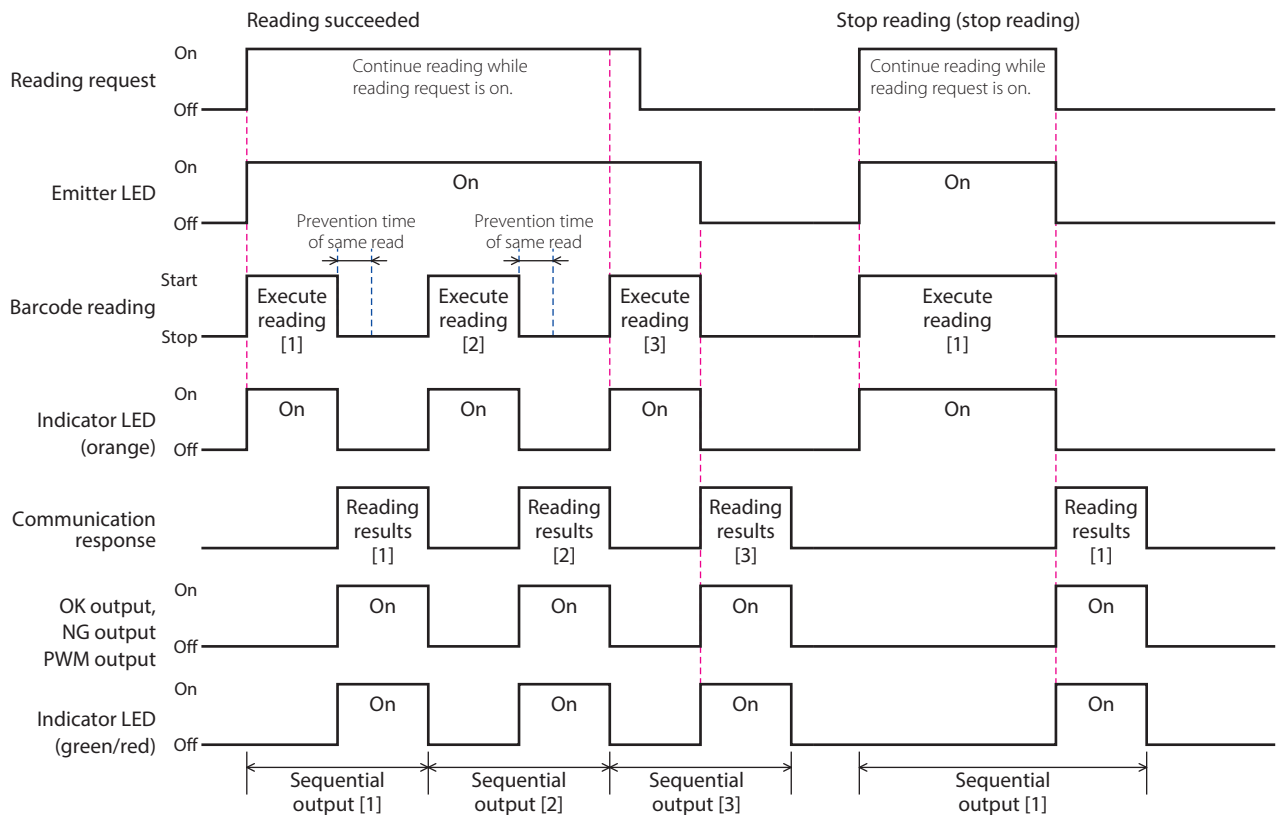

- The prevention time of same read is set between 100 ms and 25,500 ms.
- Barcode reading does not start until the communication response has completed, even when the prevention time of same read has elapsed.
- Barcodes with the same content cannot be continuously read during the prevention time of same read. If barcodes have different content, they can be read.
- A reading failure occurs only when the reading request is turned off without having been able to read even one barcode.
- The operation of the OK output, NG output, PWM output, and indicator LEDs varies depending on the settings.
- The indicator LED (orange) turns on when barcode reading starts if the reading linked control setting is enabled. It turns off when the set illumination time elapses or when barcode reading stops.
- The indicator LEDs (green/red) turn on when barcode reading is completed if the reading linked control setting is enabled. They turn off when the set illumination time elapses.
- If the reading linked control setting is enabled, reading success/failure or matched/not matched is judged when barcode reading stops, and the OK output, NG output, and PWM output are controlled according to the settings.

Multiple label read collectively output

Barcode reading starts when the reading request is turned on. Reading continues while the request is on, and when the reading request is turned off, the reading operation stops and the reading results are collectively output.

The maximum number of barcodes that can be collectively output is 16. Readout data after the 17th barcode is discarded. This becomes "edge-triggered" if the reading timeout time is set between 100 ms and 25,500 ms and "level-triggered" if set to infinity.

If the reading request is turned on with the external trigger input and level-triggered, the stop condition is the following.

- External trigger input off

To control the reading request with control commands, refer to [P. 3-10 "Start conditions and stop conditions for reading requests"](#).

The following timing chart is an example of operation by the external trigger input and level-triggered.

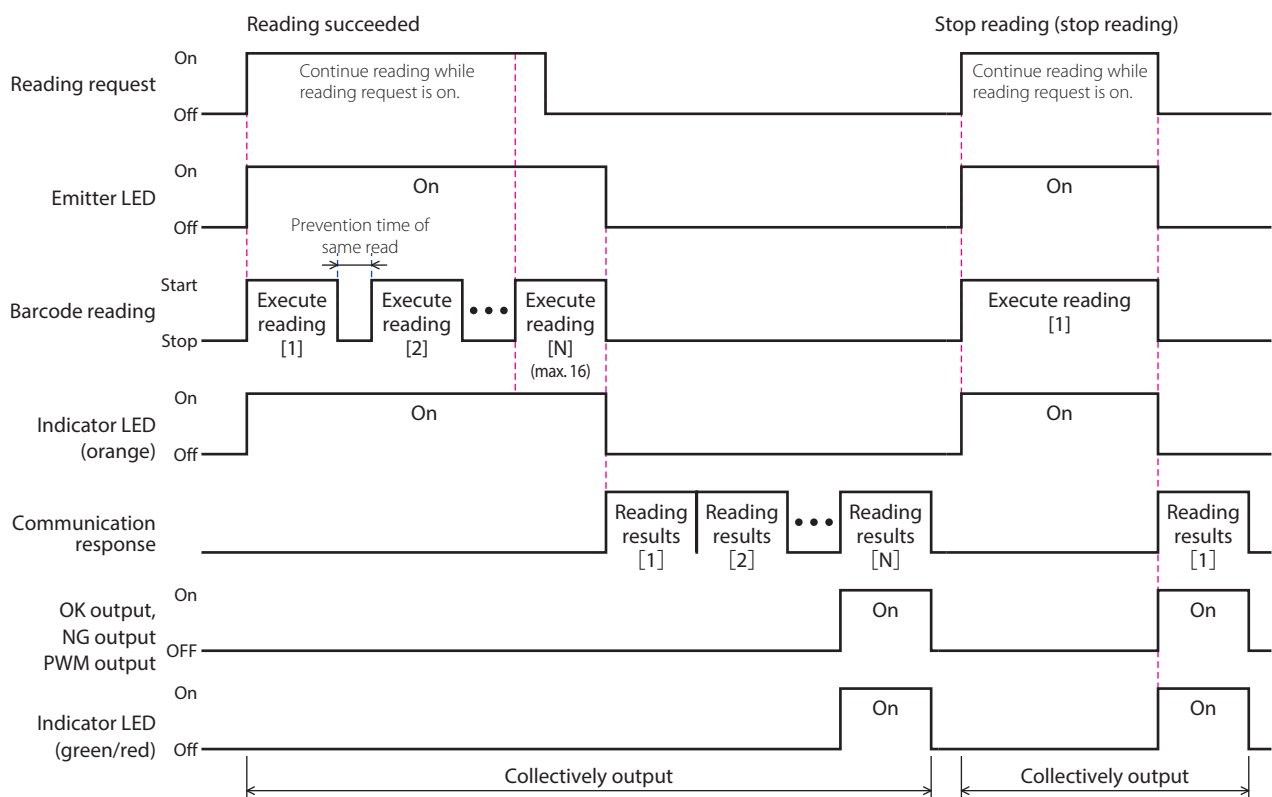

- The total number of characters for reading results [1] to [n] must be 512 characters or less. If the total number of characters exceeds 512 characters, the content of the output results is not guaranteed.
- The prevention time of same read is set between 100 ms and 25,500 ms.
- Barcodes with the same content cannot be continuously read during the prevention time of same read. If barcodes have different content, they can be read.
- The OK output, NG output, PWM output, and indicator LEDs (green/red) only reflect the final reading results.
- The operation of the OK output, NG output, PWM output, and indicator LEDs varies depending on the settings.
- The indicator LED (orange) turns on when barcode reading starts if the reading linked control setting is enabled. It turns off when the set illumination time elapses or when barcode reading stops.
- The indicator LEDs (green/red) turn on when barcode reading stops if the reading linked control setting is enabled. They turn off when the set illumination time elapses or when barcode reading starts.
- If the reading linked control setting is enabled, reading success/failure or matched/not matched is judged when barcode reading stops, and the OK output, NG output, and PWM output are controlled according to the settings.

● Start conditions and stop conditions for reading requests

Barcode reading and reading request			Operation	
Reading operation	Reading timeout time	Reading request	Start condition	Stop condition
Single label read	100 ms to 25,500 ms (Edge-triggered)	Operation button	Push the Operation button	<ul style="list-style-type: none"> • Reading succeeded • Reading timeout time (2 s) elapsed
		External trigger input	External trigger input off→on	<ul style="list-style-type: none"> • Reading succeeded • Reading timeout time elapsed
		Control commands	Start command input	<ul style="list-style-type: none"> • Reading succeeded • Reading timeout time elapsed • Stop command input
	Infinity (Level-triggered)	Operation button	*1	
		External trigger input	External trigger input on (Reading continues while trigger is on)	<ul style="list-style-type: none"> • Reading succeeded • External trigger input off
		Control commands	Start command input	<ul style="list-style-type: none"> • Reading succeeded • Stop command input
Multiple label read sequential output	100 ms to 25,500 ms (Edge-triggered)	Operation button	*1	
		External trigger input	External trigger input off→on	<ul style="list-style-type: none"> • Reading timeout time elapsed
		Control commands	Start command input	<ul style="list-style-type: none"> • Reading timeout time elapsed • Stop command input
	Infinity (Level-triggered)	Operation button	*1	
		External trigger input	External trigger input on (Reading continues while trigger is on)	<ul style="list-style-type: none"> • External trigger input off
		Control commands	Start command input	<ul style="list-style-type: none"> • Stop command input
Multiple label read Collectively output	100 ms to 25,500 ms (Edge-triggered)	Operation button	*1	
		External trigger input	External trigger input off→on	<ul style="list-style-type: none"> • Reading timeout time elapsed
		Control commands	Start command input	<ul style="list-style-type: none"> • Reading timeout time elapsed • Stop command input
	Infinity (Level-triggered)	Operation button	*1	
		External trigger input	External trigger input on (Reading continues while trigger is on)	<ul style="list-style-type: none"> • External trigger input off
		Control commands	Start command input	<ul style="list-style-type: none"> • Stop command input

*1 For the reading operation by the Operation button, the reading timeout time for single label read is forcibly fixed to 2 seconds.



When reading with control commands, after the reading operation completes, the reading request automatically turns off.

3.2.3 Output data additional information

The output data additional information adds various types of data when outputting the barcode reading results data. There are two types of formats when outputting output data to the host device.



For output data additional information settings and details, refer to "3.5 Configuration item table" -  P. 3-40 "Output data additional information".

● Single label read and multiple label read sequential output format

Global Prefix	Reading results data	Global Suffix
------------------	----------------------	------------------

- If the reading results are successful, the readout data is entered in reading results data.
- If the reading results are failed, the characters (maximum 8 characters) to output when barcode reading fails that have been set in advance are output in reading results data.
- The global prefix and global suffix can each be set up to 8 characters.

● Multiple label read collectively output format

- To separate the reading results, the collectively output separator can be specified instead of the global suffix. However, the global suffix is entered as the separator for the final reading results.
- The collectively output separator can be set up to 8 characters like the global suffix.

Example: When outputting four sets of reading results

- When not using the collectively output separator

Global Prefix	Reading results data	Global Suffix
Global Prefix	Reading results data	Global Suffix
Global Prefix	Reading results data	Global Suffix
Global Prefix	Reading results data	Global Suffix

- When using the collectively output separator

Global Prefix	Reading results data	Collectively output separator
Global Prefix	Reading results data	Collectively output separator
Global Prefix	Reading results data	Collectively output separator
Global Prefix	Reading results data	Global Suffix



Output data when performing collectively output becomes easier to manage if the collectively output separator is set to characters other than the newline characters (**CR** **LF**) and the global suffix is set to the newline characters.

Example: When the collectively output separator is set to "+", the global prefix is set to "^", and the global suffix

is set to **CR** **LF**

^ABCDEFGF**+**ABCDEFGF**+**1234567**+**ABCDEFGF**+**ABCDEFGF **CR** **LF**

● Data output format after matching

Global Prefix	Matching result	Reading results data	Global Suffix
---------------	-----------------	----------------------	---------------

- When using the matching method, the matching result is placed before the reading results data.
- If the matching result is same, the following string is placed in the matching result.

<OK:xxx>

The number in the reference data that matched the reading results data is placed in xxx (3-digit number) as a decimal value.

If the sequential input data matching result is matched, 255 is placed.

- If the comparison result is not matched, the following string is placed in the matching result.

<NG:--->



When matching is executed, the matching result is always placed.

● Additional information table

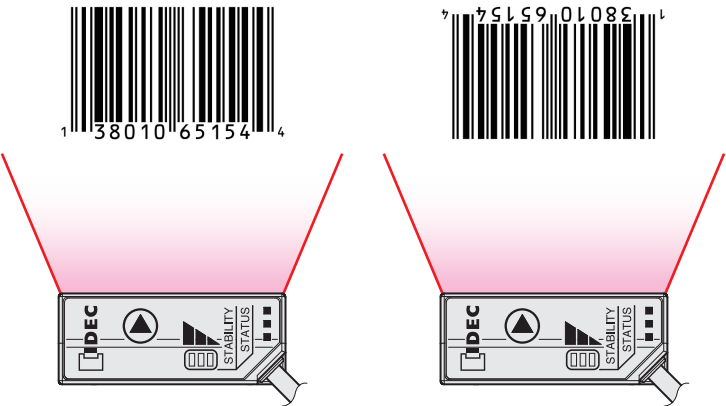
Item	Additional information examples	Comments
Global prefix	^	A prefix can be added to all output data. A maximum of 8 characters can be added.
Local prefix	P0	A prefix can be added to each type of barcode. A maximum of 4 characters can be added.
Data size	123	Adds the size of the output data in bytes. This value is expressed as a 3-digit decimal number which is not zero suppressed.
Elapsed time	12:34:56	Adds the elapsed time in HH:MM:SS format since you turn on the power to the unit. (When the power is reset, the time is reset to "00:00:00". The time is reset to 00:00:00 after 23:59:59.)
AIM ID]E0	Adds the AIM ID of the readout data Adds "]"--" when reading fails.
Label direction	D=F	Adds the label direction of the readout data This is expressed as F when forward and R when reversed. "D=" to indicate the label direction can also be added before "F" and "R". Label direction: F (forward) Label direction: R (reverse) 
Barcode length	N=032	Adds the length of the readout data This value is expressed as a 3-digit decimal number which is not zero suppressed. "N=" to indicate the length can also be added before the value.
Matching result	<OK:000>	Adds the matched or not matched judgment result during matching. When matched, the OK characters and the number xxx (3-digit numeric value) of the matched reference data is added. When matched with sequential input reference data, "<OK:255>" is added. When no match, "<NG--->" is added. This is not added except matching.
Number of decoding times	DC=0004	Adds the number of decoding times required to complete a reading. Only single label read decoding times are added.
Local suffix	S0	A suffix can be added to each type of barcode. A maximum of 4 characters can be added.
Check digit	12	Adds the check digit. This value is expressed as a 2-digit hexadecimal number. For the calculation method, refer to P. 5-10 "5. 6 Check digit calculation method" .
Global suffix	CR LF	A suffix can be added to all output data. A maximum of 8 characters can be added.

The order of the additional information is as follows.

[global prefix][local prefix][data size]_[elapsed time]_[AIM ID]_[label direction]_[barcode length]_[matching result][reading results data]_[number of decoding times][local suffix][check digit][global suffix]

Example: When all of the  P. 3-14 - "Additional information examples" items are added to the readout data "ABCDEFGH", the following data is sent.

^P0123_12:34:56_E0_D=F_N=032_<OK:000>ABCDEFGH_DC=0004S012 **CR** **LF**

Example: When the  P. 3-14 - "Additional information examples" items except [AIM ID] are added to the readout data "ABCDEFGH", the following data is sent.



^P0123_12:34:56_D=F_N=032_<OK:000>ABCDEFGH_0004S012 **CR** **LF**



- When [data size], [elapsed time], [AIM ID], [label direction], and [barcode length] are added, the item separator "_" is added to the end of each item of additional information. When these items are not added, the item separator "_" is not added.
- The order of the items cannot be changed.
- You can select to enable or disable adding the "D=" and "N=" portions of the scan direction and length.

3.2.4 Output data editing

The output data editing outputs the barcode reading results data after editing it according to the specified method. These editing methods can be used individually or in combination.

- Readout data extraction and concatenation  P. 3-16
- Replacement of control character  P. 3-17



For output data editing settings and details, refer to "3.5 Configuration item table" -  P. 3-45 "Output data editing".

● Readout data extraction and concatenation

This function extracts only the necessary portions from the readout data, concatenates the extracted data, and outputs it. Specify the extraction start position and the number of characters for extraction to extract. A maximum of 4 (0 to 3) can be specified. The extracted data is concatenated into a single set of data in order from extraction 0 and then output.

Example: When extraction 0 to 3 are specified with the following content

Extraction number	Extraction start position	Number of characters for extraction
Extraction 0	0	4
Extraction 1	6	5
Extraction 2	9	6
Extraction 3	4	3

The extraction operation is as follows.

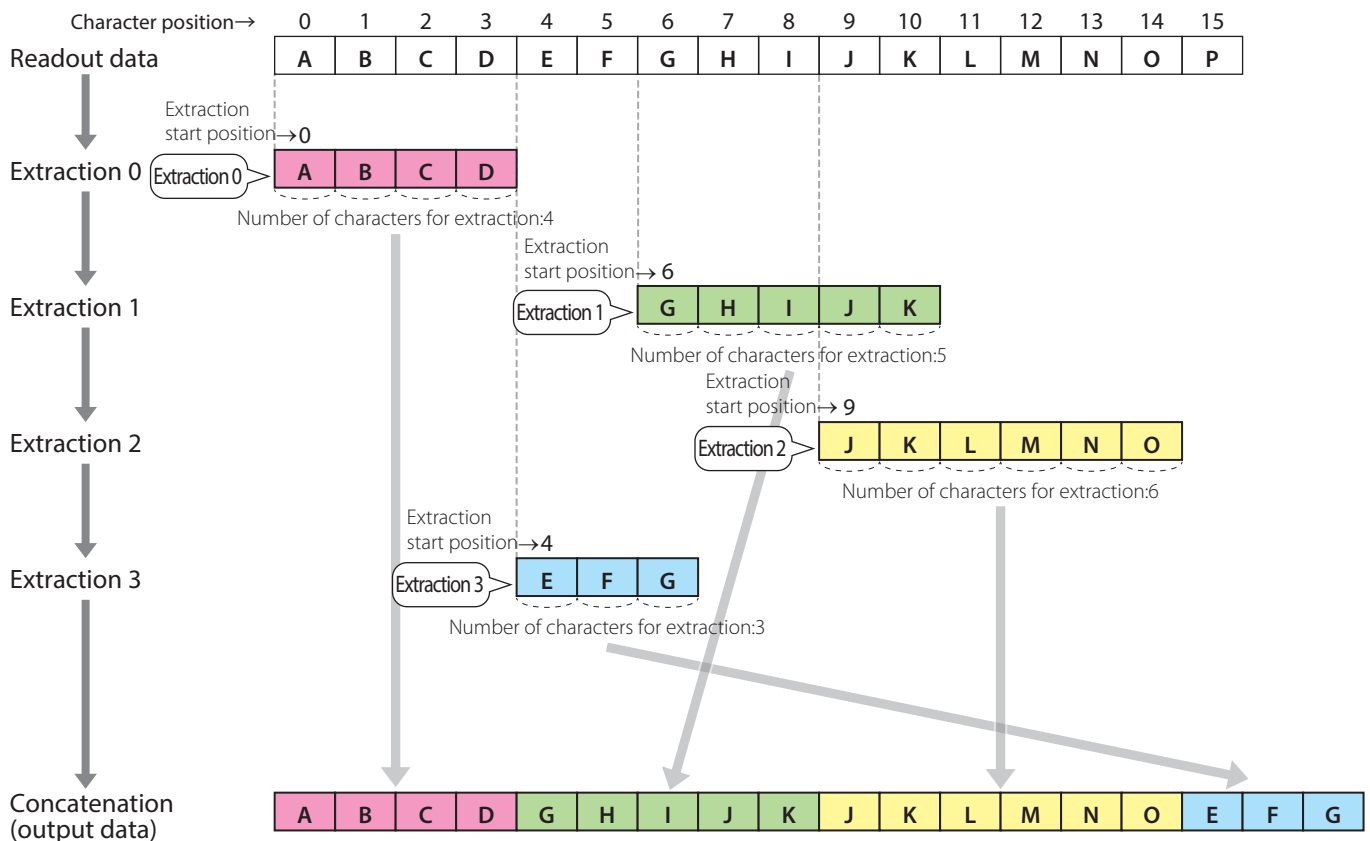

- Regardless of the extraction start position, this function concatenates the data in extraction 0, extraction 1, extraction 2, extraction 3 order.
- Extraction and concatenation are only executed when the reading result is successful.

● Replacement of control character

This function replaces certain characters with the specified characters (replacement characters) and outputs the data when control codes (00H to 1FH, 7FH) are included in the readout data.

Example: When replacement characters are specified with the following content

Character code → 40H

Replacement character @

The control code replacement operation is as follows.

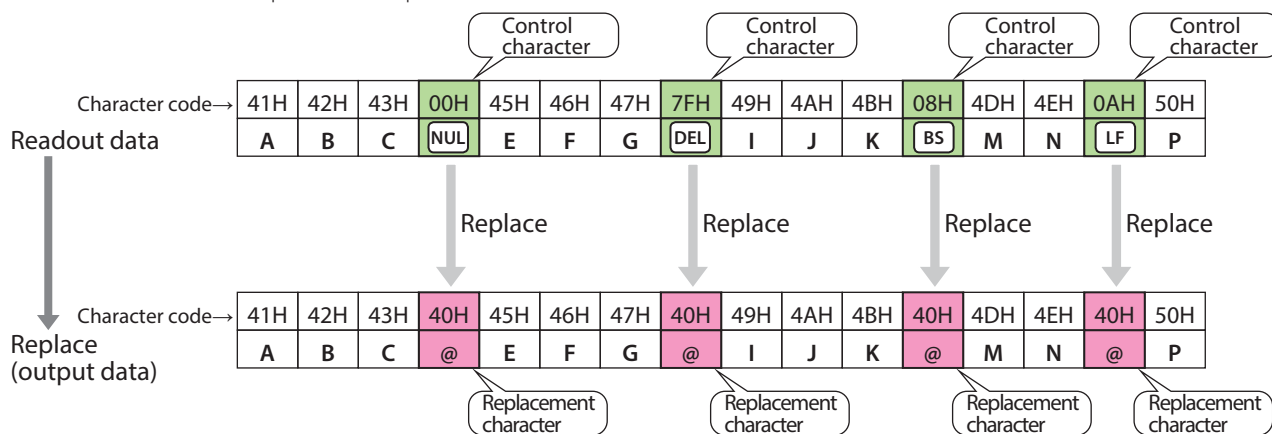

- **NUL** (00H) cannot be used for the replacement character code.
- When extraction and concatenation are enabled, replacement of control character is executed after performing extraction and concatenation.
- Replacement of control character is only executed when the reading result is successful.

3.2.5 Comparison-Matching

The matching method matches the barcode reading results data and the reference data, judges whether or not it matches, and outputs that.

The judgment result can be reflected in the indicator LEDs, OK output, NG output, PWM output, and communication interface.

There are two matching methods. These matching methods can be used individually or in combination.

- Reference data pre-registration.....☞ P. 3-18
- Reference data sequential input☞ P. 3-21



For matching method settings and details, refer to "3.5 Configuration item table" - ☞ P. 3-1 "Matching method".

● Reference data pre-registration

Register reference data for the unit in advance to match reading results data.

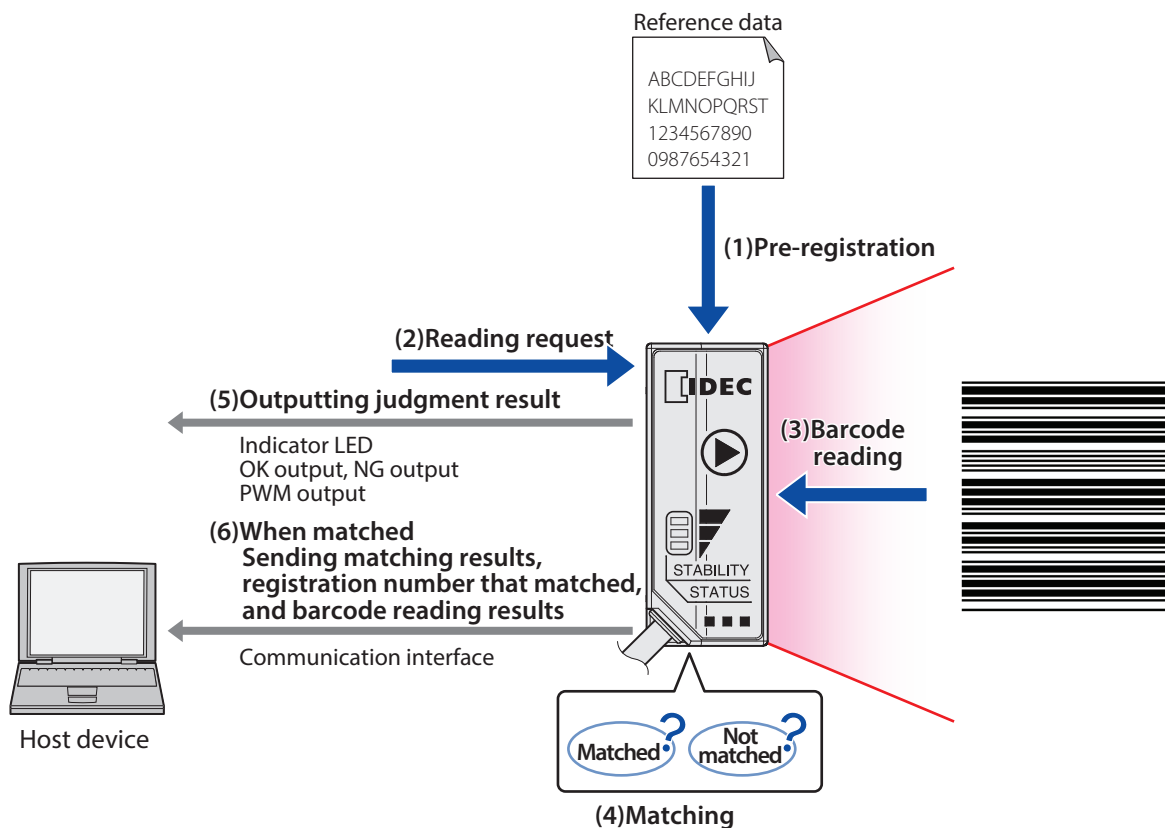

The items of reference data that can be registered in advance will vary depending on the maximum number of character of the reference data.

Maximum number of characters	Maximum registered items
4 characters	64 items
8 characters	32 items
16 characters	16 items
32 characters	8 items
64 characters	4 items

Pre-register reference data by inputting configuration commands. For details, refer to "3. 5 Configuration item table" -  P. 3-1 "3 Function".

Example: Reference data pre-registration

The following is an example of registered content.

Reference data
123
123456
abc
ABC

1 Enable the matching method.

2 Determine the number of area partitions according to the maximum number of characters and maximum number of registered items in the reference data.

With the number of area partitions as N and the maximum number of characters as x, the reference data registration area is as follows.

Number of area partitions	Maximum number of characters	Registration number	Area	
			Start	End
N (N=4, 8, 16, 32, 64)	x (256 characters ÷ N)	0	[0]	[x-1]
		1	[x]	[2x-1]
		2	[2x]	[3x-1]
		⋮	⋮	⋮
		N-1	[(N-1)x]	[Nx-1]

There are four items of reference data to register, so the number of area partitions will be set to 4 this time.

The reference data registration area is as follows.

Number of area partitions	Maximum number of characters	Registration number	Area	
			Start	End
4	64	0	[0]	[63]
		1	[64]	[127]
		2	[128]	[191]
		3	[192]	[255]

3 Register the reference data.

Register "123" for registration number 0, "123456" for registration number 1, "abc" for registration number 2, and "ABC" for registration number 3.

Registration number 0	Reference data [0]-[63]	[0]	[1]	[2]	[3]	[4]	[5]	[6]	...	[63]
		31H	32H	33H	00H	00H	00H	00H	00H	...
Registration number 1	Reference data [64]-[127]	[64]	[65]	[66]	[67]	[68]	[69]	[70]	...	[127]
		31H	32H	33H	34H	35H	36H	00H	...	00H
Registration number 2	Reference data [128]-[191]	[128]	[129]	[130]	[131]	[132]	[133]	[134]	...	[191]
		61H	62H	63H	00H	00H	00H	00H	...	00H
Registration number 3	Reference data [192]-[255]	[192]	[193]	[194]	[195]	[196]	[197]	[198]	...	[255]
		41H	42H	43H	00H	00H	00H	00H	...	00H

4 The barcode is matched with the reference data.

When the barcode "123" is read, the following data is output.

<OK:000>123 **CR** **LF**

When the barcode "AbC" is read, the following data is output.

<NG:--->AbC **CR** **LF**



- The maximum registered items for reference data is 64 items.
- The maximum number of characters for reference data changes by the number of area partitions.
- The reference data registration area is 256 characters.

● Reference data sequential input

Input reference data with the start matching control command and match the data with the reading results data. The input reference data is discarded after matching is completed.

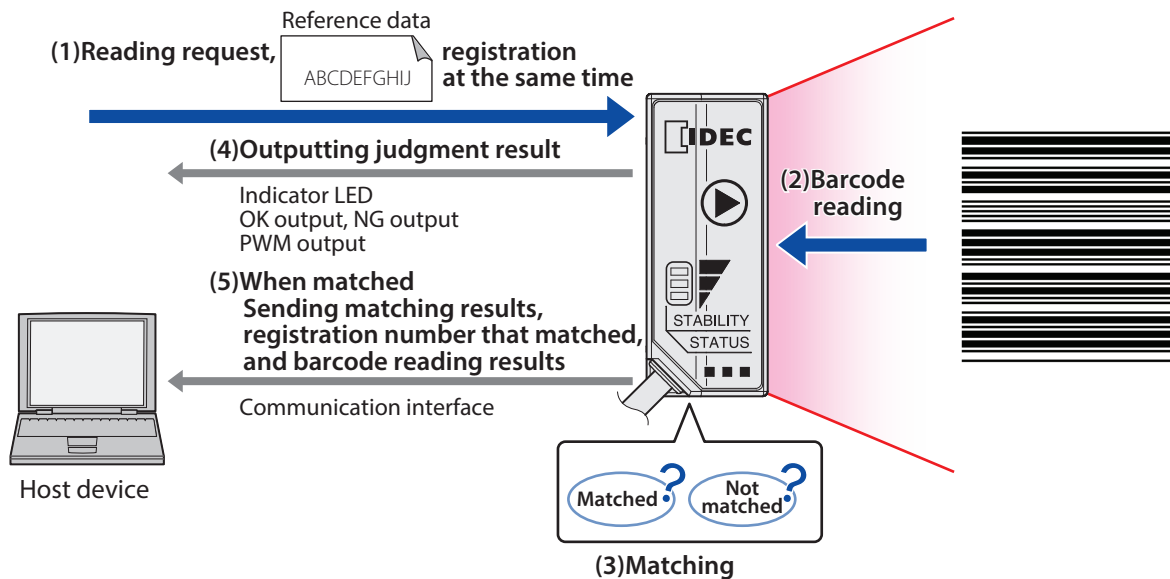

Reference data can be input with control commands. For details, refer to "5. 5 Control commands list" - [P. 5-6 "Start matching"](#).

Example: Reference data sequential input

The following is an example of registered content.

Reference data
123456

1 Input the [P. 5-6 "5. 5 Control commands list"](#) start matching command.

Start matching command

`^cmp[reference data] CR LF`

`^cmp123456 CR LF`

2 The barcode is matched with the reference data.

When the barcode "123456" is read, the following data is output.

`<OK:255*>123456 CR LF`

When the barcode "123" is read, the following data is output.

`<NG:--->123 CR LF`



- Reference data pre-registration and sequential input can be combined and used. It is useful to register reference data in advance that must always be matched and to use sequential input for reference data that you want to temporarily match.
- This function can only be executed by command.
- A maximum of 64 characters can be input.
- This function can be used even if the matching method is disabled.

● Matching

Matching of reading results data and reference data is judged by partial match.

Example: If the reference data is "ABC", the judgment results for reading results are as follows.

Reading results data	Judgment result
ABC	Matched
ABCDEFGHIJ	Matched
123ABC4567	Matched
1234567ABC	Matched
CBA	Not matched
AB	Not matched
BCDEF	Not matched
AB1CDEFG	Not matched
12345AB	Not matched

The **blue characters** are partial matches with the reference data.

3.2.6 Analysis

The analysis is for analyzing the barcode quality and the WB1F status/installation environment.

Information that can be sent

- Digitally sampled values of the analog signal when reading a barcode

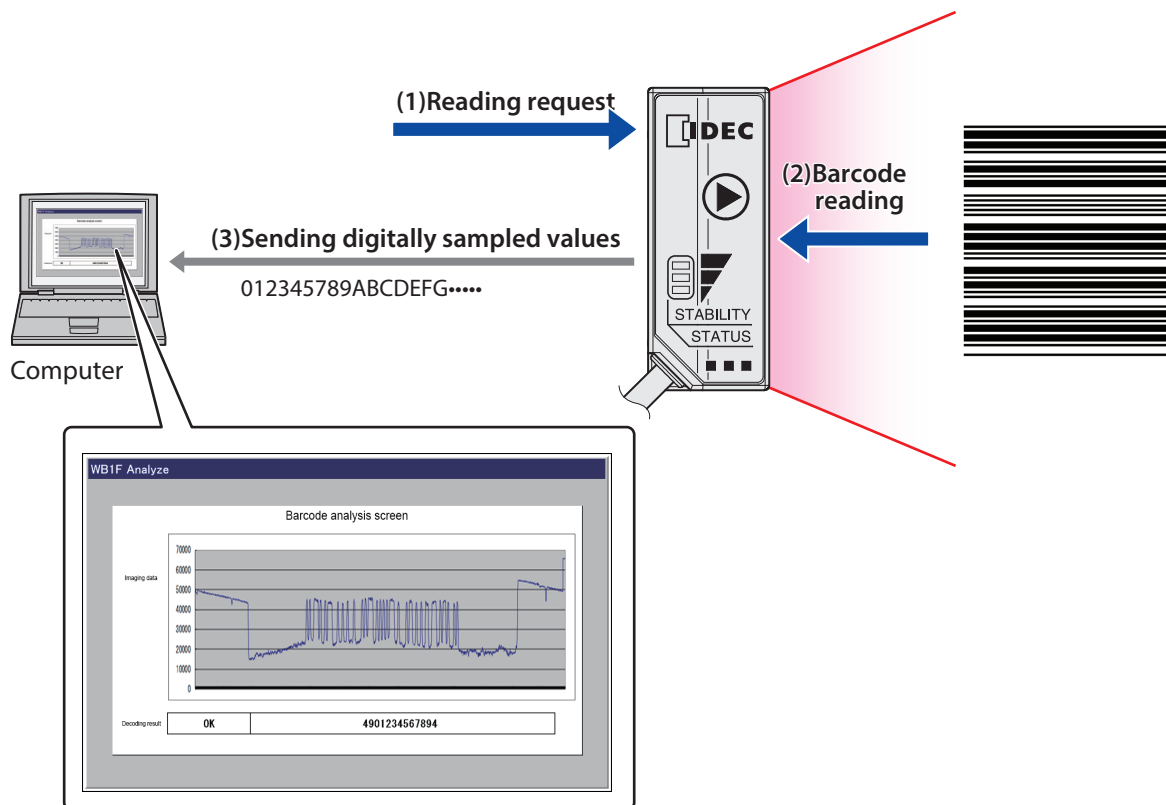

Since the analog signal waveform can be reproduced when reading a barcode from the acquired information, this function can be used to investigate the cause of reading failures, to examine the print quality of barcodes, to periodically inspect the WB1F, and to configure WB1F settings.



In order to use the analysis, you must agree to a non-disclosure agreement with IDEC. For details, please contact IDEC customer service or a sales representative.

3.2.7 Command alias

The command alias allows you to register the control commands "start barcode reading" and "stop barcode reading" as other command strings.

These registered command strings are called aliases.



For command alias settings and details, refer to "3.5 Configuration item table" - P. 3-1 "Command alias".

Alias registration

A maximum of four aliases can be registered for both the "execute barcode reading" and "stop barcode reading" control commands. Aliases can be registered with configuration commands.

The maximum number of characters for command strings is 16 characters (including the prefix and suffix).

Example: When the following content is registered as aliases

Number of characters →	0	1	2	3	4	5	6	7	8	9	10	11	12	13	14	15
Execute barcode reading																
Alias 0	STX	S	T	A	R	T	ETX									
Alias 1	o	n	CR													
Alias 2	ESC	R	E	A	D	CR	LF									
Alias 3	s	c	a	n												
Stop barcode reading																
Alias 0	STX	S	T	O	P	ETX										
Alias 1	o	f	f	CR												
Alias 2	ESC	C	A	N	C	E	L	CR	LF							
Alias 3	h	a	l	t												

To execute barcode reading can be done with the following five commands, including the original command.

- Original command: ^get CR LF
- Alias 0: STX START ETX
- Alias 1: on CR
- Alias 2: ESC READ CR
- Alias 3: scan

To stop barcode reading can be done with the following five commands, including the original command.

- Original command: **^stop** **CR** **LF**
- Alias 0: **STX** **STOP** **ETX**
- Alias 1: **off** **CR**
- Alias 2: **ESC** **CANCEL** **CR** **LF**
- Alias 3: **halt**



You can change the "start barcode reading" and "stop barcode reading" control commands to those in the command system of the system or host device already in operation.



The aliases can be configured as any desired string.
The following may not be sent or received correctly.

- strings that are the same as communication commands that already exist.
 - strings that are partial matches of other strings.
 - extremely short strings.
- etc.

First confirm operation and register the appropriate strings.

3.2.8 Communication command

The communication command sends and receives data with the connected host device via the WB1F communication interface. The arrangement for sending and receiving data is called the "communication commands".



For communication command settings and details, refer to "3.5 Configuration item table" - P. 3-48 "Communication command Function".

There are two types of communication commands: control commands and configuration commands.

■ Control commands

These commands are for directly operating the WB1F. Operations can be performed such as barcode reading and turning the indicator LEDs on and off.

■ Configuration commands

These commands change and acquire the setting values that define the manner in which the WB1F operates. The settings for RS-232 communication and the illumination pattern and time for the indicator LEDs can be changed and acquired.

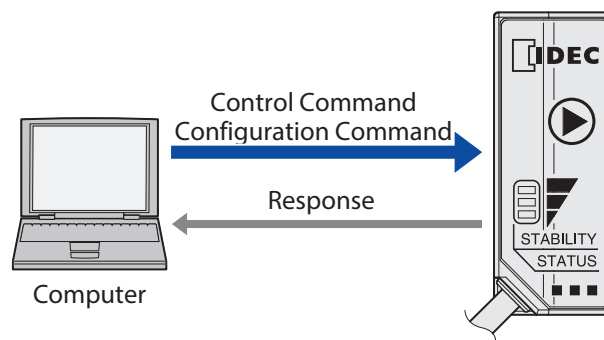

Communication data format, prefix, suffix

- The communication data format for communication commands is text (ASCII). (Excluding the prefix and suffix)
- The prefix and suffix can be changed according to the usage environment.
- This section uses the factory default state as an example.



Notes on communication

- If unwanted data may be stored in the receive buffer because noise is present or the WB1F has not been used for a long period of time while the unit is on, input "prefix+suffix". This will clear the receive buffer.
- The send buffer and the receive buffer are 512 bytes. If the buffers store more than that amount of data, data may not be correctly sent or received. Please keep this point in mind when using the WB1F in situations where RS-232 hardware flow control is enabled.

● Control commands

The WB1F can be controlled by inputting control commands from the host device to the WB1F. An example of the control command output format is as follows.

Example: To send the "indicator LED (red) on" control command

- Request (host device → WB1F)

Prefix	Mnemonic	Suffix
^	leda1	CR LF

- Response (WB1F → host device)

Normal response

Prefix	Judgment	Suffix
^	OK-00	CR LF

Error response

Prefix	Judgment	Suffix
^	NG-ff	CR LF



- The error response is when a fault occurs such as a mistake in command input.
- For the other communication commands, refer to [P. 5-6 "5. 5 Control commands list"](#).
- The check digit can be added to the control command response.
- The response time for control commands (excluding save, initial) is within 10 ms. The save command is within 2 s, the initial command is within 10 s.

● Configuration commands

Setting values can be acquired and changed by inputting configuration commands from the host device to the WB1F. An example of the control command output format is as follows.

Example: To get the setting value of address 0157 "indicator LED (red) illumination time"

•Request (host device → WB1F)

Prefix	Mnemonic	Address	Data type	Suffix
^	g	0157	x	CR LF

•Response (WB1F → host device)

Normal response

Prefix	Mnemonic	Address	Data type	data	Suffix
^	g	0157	x	1e	CR LF

Error response

Prefix	Judgment	Suffix
^	NG-ff	CR LF

Example: To change the setting value of address 0157 "indicator LED (red) illumination time"

Request (host device → WB1F)

Prefix	Mnemonic	Address	Data type	data	Suffix
^	s	0157	x	3c	CR LF

•Response (WB1F → host device)

Normal response

Prefix	Judgment	Suffix
^	OK-00	CR LF

Error response

Prefix	Judgment	Suffix
^	NG-ff	CR LF



- The error response is when a fault occurs such as a mistake in command input.
- The address range is 0000H-FFFFH. (16 bits, hexadecimal)
- The data range is 00H-FFH. (8 bits, hexadecimal)
- Both uppercase and lowercase are supported for the address and data when making a request.
- By default, the address and data for a response is lowercase. (Can be changed to uppercase)
- The check digit can be added to the configuration command request and response.
- For the other settings, refer to [P. 3-36 "3. 5 Configuration item table"](#).
- The response time for configuration commands is within 10 ms.

3.3 Setup support mode

RS-232 Type

USB Type

This mode is used to check the installation position and reading status of the WB1F.

Setup support mode has the following function.

- Setup support function  P. 3-31

3.3.1 Switching operation to setup support mode (setup support function)

There are two methods to switch to setup support mode.

Use the methods according to the situation.

The indicator LEDs (red/orange/green) will all flash when you switch to setup support mode.

Method 1 You can switch to setup support mode with the Operation button.

For details, refer to  P. 3-30 "Detailed procedure using the Operation button".

Method 2 You can switch to setup support mode with control commands.

For details, refer to  P. 5-6 "5. 5 Control commands list".

● Detailed procedure using the Operation button

- 1 When the unit's power supply is on, push the Operation button for 5 seconds.

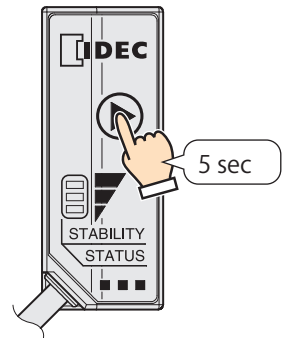

The indicator LEDs (green/orange/red) will flash and the unit will switch to the waiting state for measurement item to be selected in setup support mode.



If 5 seconds elapse with no operation, the unit returns to the same operation mode as before you switch.

2 Push the Operation button.

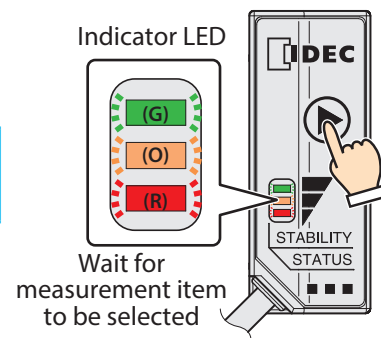

The indicator LED (green) will flash and the unit will switch to the waiting state for reading rate measurement to be executed. To execute the measurement of the reading number of times, push the Operation button.

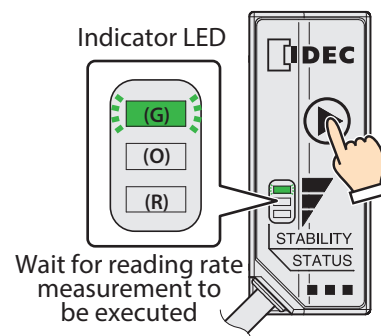

The indicator LED (orange) will flash and the unit will switch to the waiting state for measurement of the reading number of times to be executed.



Each push of the Operation button switches between the waiting states for reading rate measurement to be executed and for measurement of the reading number of times to be executed.

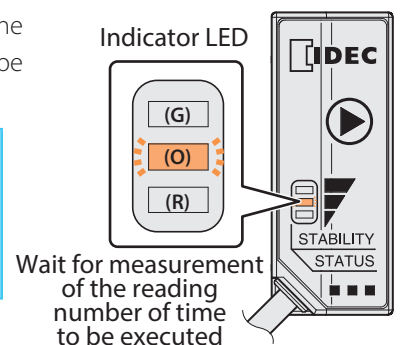

3 The measurement starts when 3 seconds elapses.

4 Push the Operation button to end the measurement.

When ended, the unit returns to the operation mode before the switch.

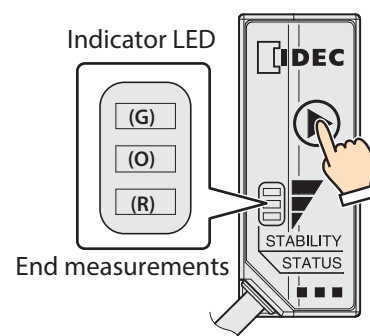

3.3.2 Setup support function

The setup support function is a function to check barcode reading when installing the WB1F and a function to measure the reading rate and reading count.

This allows you to easily adjust the WB1F installation and setup barcode positions and to adjust the line speed.

The setup support function can perform the following two measurements.

- Reading rate measurement
- Reading count measurement

● Reading rate measurement

This measurement outputs and displays the reading success rate each time 100 barcodes are read.

This can be used to check the WB1F installation and setup barcode positions.

The measurement results can be checked with the communication interface and the indicator LEDs.

An example of the measurement results output format is as follows.

Rate:[reading rate] ID:[AIM ID] Code:[reading results data] Length:[barcode length] CR LF

* At this time, the global prefix is fixed as "none" and the global suffix is fixed as "CR LF".

Example: When the reading rate is "100%", the AIM ID is "]E0", the reading results data is "4901234567894", and the barcode length is "13"

Rate:100% ID:]E0 Code:4901234567894 Length:13 CR LF

The operation of the indicator LEDs is as follows.

Reading rate	0%	1-19%	20-39%	40-59%	60-79%	80-99%	100%
LED (green)	(G)	(G)	(G)	(G)	(G)	(G)	(G)
LED (orange)	(O)	(O)	(O)	(O)	(O)	(O)	(O)
LED (red)	(R)	(R)	(R)	(R)	(R)	(R)	(R)



• To stop the measurement, push the Operation button or input the communication command suffix. (The initial value is CR LF)

• When the measurement is ended, the unit returns to the same operation mode as before you switch to setup support mode.

● Reading count measurement

This measurement outputs and displays the count of consecutively read barcodes.

It outputs and displays the count from when a barcode was successfully read to when reading a barcode failed.

This can be used to check how stable consecutive barcode reading is when reading barcodes.

The measurement results can be checked with the communication interface and the indicator LEDs.

An example of the measurement results output format is as follows.

Times:[reading count]: ID:[AIM ID] Code:[reading results data] Length:[barcode length] CR LF

* At this time, the global prefix is fixed as "none" and the global suffix is fixed as "CR LF".

Example: When the reading count is "100", the AIM ID is "]E0", the reading results data is "4901234567894", and the barcode length is "13"

Times:100: ID:]E0 Code:4901234567894 Length:13 CR LF

The operation of the indicator LEDs is as follows.

Reading count	0 times	1-9 times	10-19 times	20-29 times	30-39 times	40-49 times	50 times or more
LED (green)	(G)	(G)	(G)	(G)	(G)	(G)	(G)
LED (orange)	(O)	(O)	(O)	(O)	(O)	(O)	(O)
LED (red)	(R)	(R)	(R)	(R)	(R)	(R)	(R)





- At the start of the measurement, the "Waiting barcode label... CR LF" message is output to the communication interface.
- To stop the measurement, push the Operation button or input the communication command suffix. (The initial value is CR LF)
- When the measurement is ended, the unit returns to the same operation mode as before you switch to set-up support mode.
- The maximum value of the reading count that can be measured is 100 times.

3.4 Maintenance mode

RS-232 Type

USB Type

This mode is used for maintenance during operation after WB1F installation and to perform actions when problems occur. Maintenance mode has the following functions.

- Maintenance support..... P. 3-35
- Firmware updating..... P. 3-35

3.4.1 Switching operation to maintenance mode

There are two methods to switch to maintenance mode.

Use the methods depending on maintenance and the situation when a problem occurs.

The indicator LEDs (red/orange/green) will all flash (2 seconds on, 2 seconds off) when switching to maintenance mode.

Method 1 You can switch to maintenance mode with the Operation button.

For details, refer to  P. 3-34 "Detailed procedure using the Operation button".

Method 2 Input the "switch to maintenance mode" control command.

For details, refer to  P. 5-6 "5. 5 Control commands list".

● Detailed procedure using the Operation button

- 1 Turn on the power to the unit while pushing the Operation button.

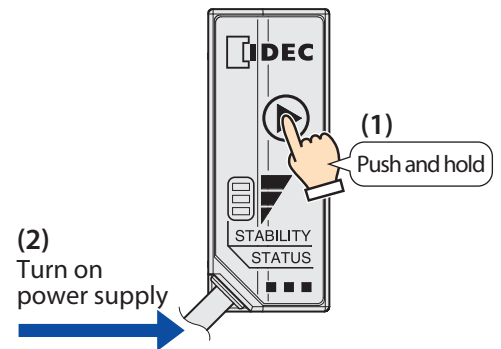

- 2 Push the Operation button until you can confirm the indicator LEDs (green/orange/red) have flashed. (Approximately 5 seconds or longer)

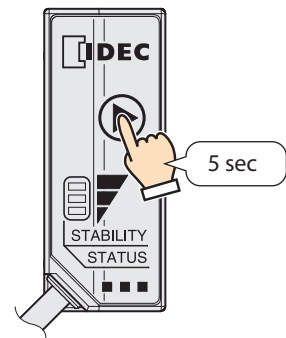

The indicator LEDs (green/orange/red) will all flash (2 seconds on, 2 seconds off) and the unit switches to maintenance mode.

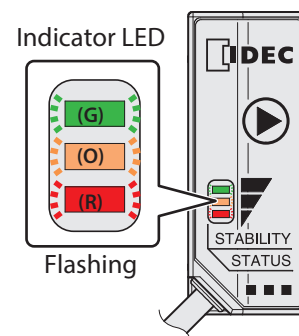

3.4.2 Maintenance support

This function temporarily operates the unit with the factory default settings when problems occur such as barcodes can no longer be read or communication is no longer possible with the host device after changing WB1F settings. This function can be executed by switching to maintenance mode.



- The setting values are restored by turning the power on/off, resetting, or switching the mode.
- When a barcode is read, the flashing LEDs (green/orange/red) turn off. The LEDs (green/orange/red) will flash again after 5 seconds.
- After switching to maintenance mode, you can restore the setting values to the factory defaults by reading the initialization barcode. For the initialization barcode, refer to  P. 5-16 "5. 10 Configuration barcode".

3.4.3 Firmware updating

This function updates the WB1F firmware. This function can be executed by using the WB1F support tool



- New functions that are added to the firmware can be used by executing a firmware version upgrade.
- The latest firmware is available on the IDEC website. Check whether or not there is new firmware on the IDEC website.

3.5 Configuration item table

The settings and setting values that define the manner in which the WB1F operates are as follows.

You can define the customized operation of the WB1F for your environment by changing the setting values.

In addition, you can change to the setting value by reading the barcode which is described in menu sheet (WB1F-MENU-SHEET-E, B-1782).



- When setting values are changed, the setting values must be saved with the "save setting values" control command.
If the power is turned off, the unit is reset, or the operation mode is changed without executing "save setting values", the setting values are restored to the same values as before they are changed.
- Do not access or change any settings that are not listed here.
- Do not access or change any settings in reserved areas.



- When configuring settings that specify ASCII code for the setting value, please be aware of the following points.
 - **NUL** (00H) cannot be used as a setting value.
 - The characters up to the first **NUL** (00H) are considered the data and any data after that is not valid.
 Setting value (hex) of bold face is default value (Setting at the time of factory shipments).
- Note the following points when configuring items related to the decoder.
 - Setting all symbols that will not be used as Reading prohibited is recommended.
 - If multiple symbols of the following are set to Reading allowed, unexpected read results may be output depending on the symbol specifications.
 - Code39, CIP39, Italian Pharm
 - Use "All symbology Reading allowed/prohibited" to rewrite the read allowed/prohibited setting values in the decoder settings for each symbology at once.
 - Make sure the final read allowed/prohibited status is configured as intended for each symbology.

Item	Sub item	Address (hex)	Size (dec)	Default (hex)	Setting value (hex)	Remarks
Reserved		0000-01FF	256	-	-	
RS-232 settings	Communication speed	0100	1	03	00: 1,200 bps 01: 2,400 bps 02: 4,800 bps 03: 9,600 bps 04: 19,200 bps 05: 38,400 bps 06: 57,600 bps 07: 115,200 bps 0a: 600 bps	After saved (save), the settings are reflected when the power is turned on, the unit is reset, or the operation mode is changed.
	Data length	0101	1	01	00: 7 bits 01: 8 bits	
	Parity	0102	1	01	00: None 01: Even 02: Odd	
	Stop bits	0103	1	00	00: 1 bit 01: 2 bits	
	Flow control	0104	1	00	00: None 01: CTS/RTS	
	Reserved	0105-011F	27	-	-	

Item	Sub item	Address (hex)	Size (dec)	Default (hex)	Setting value (hex)	Remarks
OK/NG output settings	OK output/reading linked control	0120	1	01	00: Disabled 01: Enabled	Enable to link to the reading operation.
	Reserved	0121	1	-	-	
	OK output polarity	0122	1	01	00: Off 01: On	On: The transistor is turned on and current flows. Off: The transistor is turned off and the circuit is open. When the setting value is changed, it is immediately reflected in the OK output.
	OK output duration	0123	1	0A	00: Infinity 01-FF: Setting value by 10ms step (10 ms to 2,550 ms)	
	NG output/reading linked control	0124	1	01	00: Disabled 01: Enabled	Enable to link to the reading operation.
	Reserved	0125	1	-	-	
OK/NG output settings	NG output polarity	0126	1	01	00: Off 01: On	On: The transistor is turned on and current flows. Off: The transistor is turned off and the circuit is open. When the setting value is changed, it is immediately reflected in the NG output.
	NG output duration	0127	1	0A	00: Infinity 01-FF: Setting value by 10ms step (10 ms to 2,550 ms)	
	Reserved	0128-012F	8	-	-	
External trigger input settings	Reading start with External trigger input	0130	1	01	00: Disabled 01: Enabled	Enable when you want to perform reading with an external trigger input operation.
	External trigger input active level	0131	1	01	00: High 01: Low	
	External Trigger input filter time	0132	1	20	01-20 (1 ms to 32ms)	Start reading barcode by turning external trigger input on for longer than the setting value. To shorten the setting value may affect noise resistance, so fully evaluate this when using product.
	Reserved	0133-013F	13	-	-	
PWM output settings	PWM output reading linked control when successful	0140	1	01	00: Disabled 01: Enabled	Enable to link to the reading operation.
	Reserved	0141	1	-	-	
	PWM output frequency when successful	0142	2	D0	0014-4E20: Setting value Hz (20 Hz to 20,000 Hz)	Lower byte setting
		0143		07		Upper byte setting
	PWM output duration when successful	0144	1	14	00: Infinity 01-FF: Setting value by 10ms step (10 ms to 2,550 ms)	Open state when the output stops.
	PWM output duty when successful	0145	1	32	01-63: Setting value % (1% to 99%)	Set the percentage when on.
	Reserved	0146	1	-	-	
	Reserved	0147	1	-	-	
	PWM output reading linked control when failed	0148	1	01	00: Disabled 01: Enabled	
Reserved	0149	1	-	-		

Item	Sub item	Address (hex)	Size (dec)	Default (hex)	Setting value (hex)	Remarks
PWM output settings	PWM output frequency when failed	014A	2	F4	0014-4E20: Setting value Hz (20 Hz to 20,000 Hz)	Lower byte setting
		014B		01		Upper byte setting
	PWM output duration when failed	014C	1	14	00: Infinity 01-FF: Setting value by 10ms step (10 ms to 2,550 ms)	Open state when the output stops.
	PWM output duty when failed	014D	1	32	01-63: Setting value % (1% to 99%)	Set the percentage when on.
	Reserved	014E	1	-	-	
	Reserved	014F	1	-	-	
Indicator LED settings	Indicator LED (green) reading linked control	0150	1	01	00: Disabled 01: Enabled	Enable to link to the reading operation.
	Reserved	0151	1	-	-	
	Indicator LED (green) illumination pattern	0152	1	01	00: Off 01: On 02: Flashing (high speed) 03: Flashing (medium speed) 04: Flashing (low speed)	
	Indicator LED (green) illumination time	0153	1	1E	00: Infinity 01-FF: Setting value by 10ms step (10 ms to 2,550 ms)	
	Indicator LED (red) reading linked control	0154	1	01	00: Disabled 01: Enabled	Enable to link to the reading operation.
	Reserved	0155	1	-	-	
	Indicator LED (red) illumination pattern	0156	1	01	00: Off 01: On 02: Flashing (high speed) 03: Flashing (medium speed) 04: Flashing (low speed)	
	Indicator LED (red) illumination time	0157	1	1E	00: Infinity 01-FF: Setting value by 10ms step (10 ms to 2,550 ms)	
	Indicator LED (orange) reading linked control	0158	1	01	00: Disabled 01: Enabled	Enable to link to the reading operation.
	Reserved	0159	1	-	-	
	Indicator LED (orange) illumination pattern	015A	1	01	00: Off 01: On 02: Flashing (high speed) 03: Flashing (medium speed) 04: Flashing (low speed)	
	Indicator LED (orange) illumination time	015B	1	00	00: Infinity 01-FF: Setting value by 10ms step (10 ms to 2,550 ms)	
	Reserved	015C	1	-	-	
	Reserved	015D	1	-	-	
	Reserved	015E	1	-	-	
Reserved	015F	1	-	-		
Operation button settings	Reading start with Operation button	0160	1	01	00: Disabled 01: Enabled	Enable when you want to perform reading with the operation of the Operation button.
	Reserved	0161-016F	15	-	-	

Item	Sub item	Address (hex)	Size (dec)	Default (hex)	Setting value (hex)	Remarks
CCD setting	CCD drive setting	0170	1	00	00: Standard 01: Always	Standard: Driven each time reading occurs. Always: Driven regularly after startup.
	Number of CCD Idling times	0171	1	05	01-0A: (0 to 10 times)	Specify the number of preliminary operations to be run until the CCD drive is stabilized. Entering a larger value will increase stability but will decrease the read speed. When "CCD drive setting" is set to "Always", set this setting to "0".
Reserved		0172-01FF	142	-	-	
Barcode reading	Reading operation selection	0200	1	00	00: Single label read 01: Multiple label read sequential output 02: Multiple label read collectively output	
	Reading timeout time	0201	1	14	00: Infinity 01-FF: Setting value by 100ms step (100 ms to 25,500 ms)	Set the maximum time to continue the reading operation from the occurrence of a reading request. Set the setting value to infinity in the usage that the reading operation synchronizes with the external trigger input or the start/stop barcode reading command.
	Prevention time of same read	0202	1	14	00: None 01-FF: Setting value by 100ms step (100 ms to 25,500 ms)	Sets the time that the same barcode will not be read when performing multiple label reading.
	Verification count	0203	1	01	0-10: Verification count	Sets the number of times to check that there are no mistakes in the readout data. Increasing the verification count can reduce erroneous reads, but the response speed will also decrease.
	Reading start when power on	0204	1	00	00: Disabled 01: Enabled	When the setting value is enabled, and the WB1F is power up, the WB1F starts reading barcode. Reading operation selection, reading timeout time, prevention time of same read, and verification count follow the setting value.
Reserved		0205-027F	123	-	-	

Item	Sub item	Address (hex)	Size (dec)	Default (hex)	Setting value (hex)	Remarks
Output data additional information	Global prefix addition	0280	1	00	00: Disabled 01: Enabled	
	Global suffix addition	0281	1	01	00: Disabled 01: Enabled	
	Local prefix addition	0282	1	00	00: Disabled 01: Enabled	You can set the data to be added to each type of barcode.
	Local suffix addition	0283	1	00	00: Disabled 01: Enabled	You can set the data to be added to each type of barcode.
	Data size addition	0284	1	00	00: Disabled 01: Enabled	
	Reserved	0285	1	-	-	
	Elapsed time addition	0286	1	00	00: Disabled 01: Enabled	
	AIM ID addition	0287	1	00	00: Disabled 01: Enabled	
	Reserved	0288	1	-	-	
	Label direction addition	0289	1	00	00: Disabled 01: Enabled	
	Code length addition	028A	1	00	00: Disabled 01: Enabled	
	Reserved	028B	1	-	-	
	Check digit addition	028C	1	00	00: Disabled 01: Enabled	
	Label option addition	028D	1	00	00: Disabled 01: Enabled	
	Collectively output separator specification	028E	1	00	00: Disabled 01: Enabled	
	Output addition when reading failed	028F	1	01	00: Disabled 01: Enabled	
	No response when reading failed	0290	1	00	00: Disabled 01: Enabled	When the setting value is enabled and the WB1F fails reading the barcode, no data is output.
	Reserved	0291-0293	3	-	-	
	Number of decoding times addition	0294	1	00	00: Disabled 01: Enabled	
	Reserved	0295-0297	2	-	-	
Output string data when reading failed	0298	8	3F	00-FF: ASCII code	The initial state is a "?" response when reading fails.	
	0299		00	00-FF: ASCII code		
	029A		00	00-FF: ASCII code		
	029B		00	00-FF: ASCII code		
	029C		00	00-FF: ASCII code		
	029D		00	00-FF: ASCII code		
	029E		00	00-FF: ASCII code		
	029F		00	00-FF: ASCII code		

Item	Sub item	Address (hex)	Size (dec)	Default (hex)	Setting value (hex)	Remarks
Output data additional information	Global Prefix data	02A0	8	5E	00-FF: ASCII code	
		02A1		00	00-FF: ASCII code	
		02A2		00	00-FF: ASCII code	
		02A3		00	00-FF: ASCII code	
		02A4		00	00-FF: ASCII code	
		02A5		00	00-FF: ASCII code	
		02A6		00	00-FF: ASCII code	
	02A7	00	00-FF: ASCII code			
	Global Suffix data	02A8	8	0D	00-FF: ASCII code	
		02A9		0A	00-FF: ASCII code	
		02AA		00	00-FF: ASCII code	
		02AB		00	00-FF: ASCII code	
		02AC		00	00-FF: ASCII code	
		02AD		00	00-FF: ASCII code	
		02AE		00	00-FF: ASCII code	
	02AF	00	00-FF: ASCII code			
	Local Prefix data reading failure	02B0	4	50	00-FF: ASCII code	
		02B1		30	00-FF: ASCII code	
		02B2		30	00-FF: ASCII code	
		02B3		3B	00-FF: ASCII code	
	Local Prefix data Code39	02B4	4	50	00-FF: ASCII code	
		02B5		30	00-FF: ASCII code	
		02B6		31	00-FF: ASCII code	
		02B7		3B	00-FF: ASCII code	
	Local Prefix data Codabar	02B8	4	50	00-FF: ASCII code	
		02B9		30	00-FF: ASCII code	
		02BA		32	00-FF: ASCII code	
		02BB		3B	00-FF: ASCII code	
	Local Prefix data Interleaved 2of5	02BC	4	50	00-FF: ASCII code	
		02BD		30	00-FF: ASCII code	
		02BE		33	00-FF: ASCII code	
		02BF		3B	00-FF: ASCII code	
Local Prefix data Standard 2of5	02C0	4	50	00-FF: ASCII code		
	02C1		30	00-FF: ASCII code		
	02C2		34	00-FF: ASCII code		
	02C3		3B	00-FF: ASCII code		
Local prefix data Matrix 2of5	02C4	4	50	00-FF: ASCII code		
	02C5		30	00-FF: ASCII code		
	02C6		35	00-FF: ASCII code		
	02C7		3B	00-FF: ASCII code		
Local Prefix data IATA 2of5	02C8	4	50	00-FF: ASCII code		
	02C9		30	00-FF: ASCII code		
	02CA		36	00-FF: ASCII code		
	02CB		3B	00-FF: ASCII code		
Local Prefix data Coop 2of5	02CC	4	50	00-FF: ASCII code		
	02CD		30	00-FF: ASCII code		
	02CE		37	00-FF: ASCII code		
	02CF		3B	00-FF: ASCII code		
Local Prefix data Scode	02D0	4	50	00-FF: ASCII code		
	02D1		30	00-FF: ASCII code		
	02D2		38	00-FF: ASCII code		
	02D3		3B	00-FF: ASCII code		
Local Prefix data Chinese Post Matrix	02D4	4	50	00-FF: ASCII code		
	02D5		30	00-FF: ASCII code		
	02D6		39	00-FF: ASCII code		
	02D7		3B	00-FF: ASCII code		

Item	Sub item	Address (hex)	Size (dec)	Default (hex)	Setting value (hex)	Remarks
Output data additional information	Local	02D8	4	50	00-FF: ASCII code	
	Prefix	02D9		30	00-FF: ASCII code	
	data	02DA		61	00-FF: ASCII code	
	UPC-A	02DB		3B	00-FF: ASCII code	
	Local	02DC	4	50	00-FF: ASCII code	
	Prefix	02DD		30	00-FF: ASCII code	
	data	02DE		62	00-FF: ASCII code	
	UPC-E0	02DF		3B	00-FF: ASCII code	
	Local	02E0	4	50	00-FF: ASCII code	
	Prefix	02E1		30	00-FF: ASCII code	
	data	02E2		63	00-FF: ASCII code	
	UPC-E1	02E3		3B	00-FF: ASCII code	
	Local	02E4	4	50	00-FF: ASCII code	
	Prefix	02E5		30	00-FF: ASCII code	
	data	02E6		64	00-FF: ASCII code	
	EAN-13	02E7		3B	00-FF: ASCII code	
	Local	02E8	4	50	00-FF: ASCII code	
	Prefix	02E9		30	00-FF: ASCII code	
	data	02EA		65	00-FF: ASCII code	
	EAN-8	02EB		3B	00-FF: ASCII code	
	Local	02EC	4	50	00-FF: ASCII code	
	Prefix	02ED		30	00-FF: ASCII code	
	data	02EE		66	00-FF: ASCII code	
	Code128	02EF		3B	00-FF: ASCII code	
	Local	02F0	4	50	00-FF: ASCII code	
	Prefix	02F1		31	00-FF: ASCII code	
	data	02F2		30	00-FF: ASCII code	
	GS1-128	02F3		3B	00-FF: ASCII code	
	Local	02F4	4	50	00-FF: ASCII code	
	Prefix	02F5		31	00-FF: ASCII code	
	data	02F6		31	00-FF: ASCII code	
	Code93	02F7		3B	00-FF: ASCII code	
	Local	02F8	4	50	00-FF: ASCII code	
	Prefix	02F9		31	00-FF: ASCII code	
	data	02FA		32	00-FF: ASCII code	
	MSI/Plessey	02FB		3B	00-FF: ASCII code	
	Local	02FC	4	50	00-FF: ASCII code	
	Prefix	02FD		31	00-FF: ASCII code	
	data	02FE		33	00-FF: ASCII code	
	Italian Pharmacy (Code32)	02FF		3B	00-FF: ASCII code	
Local	0300	4	50	00-FF: ASCII code		
Prefix	0301		31	00-FF: ASCII code		
data	0302		34	00-FF: ASCII code		
CIP39	0303		3B	00-FF: ASCII code		
Local	0304	4	50	00-FF: ASCII code		
Prefix	0305		31	00-FF: ASCII code		
data	0306		35	00-FF: ASCII code		
Tri-Optic	0307		3B	00-FF: ASCII code		
Local	0308	4	50	00-FF: ASCII code		
Prefix	0309		31	00-FF: ASCII code		
data	030A		36	00-FF: ASCII code		
TELEPEN	030B		3B	00-FF: ASCII code		
Local	030C	4	50	00-FF: ASCII code		
Prefix	030D		31	00-FF: ASCII code		
data	030E		37	00-FF: ASCII code		
Code11	030F		3B	00-FF: ASCII code		

Item	Sub item	Address (hex)	Size (dec)	Default (hex)	Setting value (hex)	Remarks
Output data additional information	Local Prefix data	0310	4	50	00-FF: ASCII code	
	GS1 Databar Expanded	0311		31	00-FF: ASCII code	
		0312		38	00-FF: ASCII code	
		0313		3B	00-FF: ASCII code	
	Local Prefix data	0314	4	50	00-FF: ASCII code	
	GS1 Databar Limited	0315		31	00-FF: ASCII code	
		0316		39	00-FF: ASCII code	
		0317		3B	00-FF: ASCII code	
	Local Prefix data	0318	4	50	00-FF: ASCII code	
	GS1 Databar Omni-directional	0319		31	00-FF: ASCII code	
		031A		61	00-FF: ASCII code	
		031B		3B	00-FF: ASCII code	
	Reserved	031C-036F	84	-	-	
	Local Suffix data	0370	4	53	00-FF: ASCII code	
	reading failure	0371		30	00-FF: ASCII code	
		0372		30	00-FF: ASCII code	
		0373		3B	00-FF: ASCII code	
	Local Suffix data	0374	4	53	00-FF: ASCII code	
	Code39	0375		30	00-FF: ASCII code	
		0376		31	00-FF: ASCII code	
		0377		3B	00-FF: ASCII code	
	Local Suffix data	0378	4	53	00-FF: ASCII code	
	Codabar	0379		30	00-FF: ASCII code	
		037A		32	00-FF: ASCII code	
		037B		3B	00-FF: ASCII code	
	Local suffix data	037C	4	53	00-FF: ASCII code	
	Interleaved 2of5	037D		30	00-FF: ASCII code	
		037E		33	00-FF: ASCII code	
		037F		3B	00-FF: ASCII code	
	Local Suffix data	0380	4	53	00-FF: ASCII code	
	Standard 2of5	0381		30	00-FF: ASCII code	
		0382		34	00-FF: ASCII code	
	0383	3B		00-FF: ASCII code		
Local Suffix data	0384	4	53	00-FF: ASCII code		
Matrix 2of5	0385		30	00-FF: ASCII code		
	0386		35	00-FF: ASCII code		
	0387		3B	00-FF: ASCII code		
Local Suffix data	0388	4	53	00-FF: ASCII code		
IATA 2of5	0389		30	00-FF: ASCII code		
	038A		36	00-FF: ASCII code		
	038B		3B	00-FF: ASCII code		
Local Suffix data	038C	4	53	00-FF: ASCII code		
Coop 2of5	038D		30	00-FF: ASCII code		
	038E		37	00-FF: ASCII code		
	038F		3B	00-FF: ASCII code		
Local Suffix data	0390	4	53	00-FF: ASCII code		
Scode	0391		30	00-FF: ASCII code		
	0392		38	00-FF: ASCII code		
	0393		3B	00-FF: ASCII code		
Local Suffix data	0394	4	53	00-FF: ASCII code		
Chinese Post Matrix	0395		30	00-FF: ASCII code		
	0396		39	00-FF: ASCII code		
	0397		3B	00-FF: ASCII code		

Item	Sub item	Address (hex)	Size (dec)	Default (hex)	Setting value (hex)	Remarks
Output data additional information	Local	0398	4	53	00-FF: ASCII code	
	Suffix	0399		30	00-FF: ASCII code	
	data	039A		61	00-FF: ASCII code	
	UPC-A	039B		3B	00-FF: ASCII code	
	Local	039C	4	53	00-FF: ASCII code	
	Suffix	039D		30	00-FF: ASCII code	
	data	039E		62	00-FF: ASCII code	
	UPC-E0	039F		3B	00-FF: ASCII code	
	Local	03A0	4	53	00-FF: ASCII code	
	Suffix	03A1		30	00-FF: ASCII code	
	data	03A2		63	00-FF: ASCII code	
	UPC-E1	03A3		3B	00-FF: ASCII code	
	Local	03A4	4	53	00-FF: ASCII code	
	Suffix	03A5		30	00-FF: ASCII code	
	data	03A6		64	00-FF: ASCII code	
	EAN-13	03A7		3B	00-FF: ASCII code	
	Local	03A8	4	53	00-FF: ASCII code	
	Suffix	03A9		30	00-FF: ASCII code	
	data	03AA		65	00-FF: ASCII code	
	EAN-8	03AB		3B	00-FF: ASCII code	
	Local	03AC	4	53	00-FF: ASCII code	
	Suffix	03AD		30	00-FF: ASCII code	
	data	03AE		66	00-FF: ASCII code	
	Code128	03AF		3B	00-FF: ASCII code	
	Local	03B0	4	53	00-FF: ASCII code	
	Suffix	03B1		31	00-FF: ASCII code	
	data	03B2		30	00-FF: ASCII code	
	GS1-128	03B3		3B	00-FF: ASCII code	
	Local	03B4	4	53	00-FF: ASCII code	
	Suffix	03B5		31	00-FF: ASCII code	
	data	03B6		31	00-FF: ASCII code	
	Code93	03B7		3B	00-FF: ASCII code	
	Local	03B8	4	53	00-FF: ASCII code	
	Suffix	03B9		31	00-FF: ASCII code	
	data	03BA		32	00-FF: ASCII code	
	MSI/Plessey	03BB		3B	00-FF: ASCII code	
	Local	03BC	4	53	00-FF: ASCII code	
	Suffix	03BD		31	00-FF: ASCII code	
	data	03BE		33	00-FF: ASCII code	
	Italian Pharmacy (Code32)	03BF		3B	00-FF: ASCII code	
Local	03C0	4	53	00-FF: ASCII code		
Suffix	03C1		31	00-FF: ASCII code		
data	03C2		34	00-FF: ASCII code		
CIP39	03C3		3B	00-FF: ASCII code		
Local	03C4	4	53	00-FF: ASCII code		
Suffix	03C5		31	00-FF: ASCII code		
data	03C6		35	00-FF: ASCII code		
Tri-Optic	03C7		3B	00-FF: ASCII code		
Local	03C8	4	53	00-FF: ASCII code		
Suffix	03C9		31	00-FF: ASCII code		
data	03CA		36	00-FF: ASCII code		
TELEPEN	03CB		3B	00-FF: ASCII code		
Local	03CC	4	53	00-FF: ASCII code		
Suffix	03CD		31	00-FF: ASCII code		
data	03CE		37	00-FF: ASCII code		
Code11	03CF		3B	00-FF: ASCII code		



Item	Sub item	Address (hex)	Size (dec)	Default (hex)	Setting value (hex)	Remarks
Output data additional information	Local Suffix data GS1 Databar Expanded	03D0	4	53	00-FF: ASCII code	
		03D1		31	00-FF: ASCII code	
		03D2		38	00-FF: ASCII code	
		03D3		3B	00-FF: ASCII code	
	Local Suffix data GS1 Databar Limited	03D4	4	53	00-FF: ASCII code	
		03D5		31	00-FF: ASCII code	
		03D6		39	00-FF: ASCII code	
		03D7		3B	00-FF: ASCII code	
	Local Suffix data GS1 Databar Omni-directional	03D8	4	53	00-FF: ASCII code	
		03D9		31	00-FF: ASCII code	
		03DA		61	00-FF: ASCII code	
		03DB		3B	00-FF: ASCII code	
	Reserved	03DC-042F	84	-	-	
	Collectively output separator data	0430	8	3A	00-FF: ASCII code	
		0431		00	00-FF: ASCII code	
		0432		00	00-FF: ASCII code	
		0433		00	00-FF: ASCII code	
0434		00		00-FF: ASCII code		
0435		00		00-FF: ASCII code		
0436		00		00-FF: ASCII code		
0437	00	00-FF: ASCII code				
Reserved	0438-043F	8	-	-		
Output data editing	Function enabled	0440	1	00	00: Disabled 01: Enabled	
	Extraction start position[0]	0441	1	00	00-3F (0 position character to 63rd character)	
	Extraction start position[1]	0442	1	00	00-3F (0 position character to 63rd character)	
	Extraction start position[2]	0443	1	00	00-3F (0 position character to 63rd character)	
	Extraction start position[3]	0444	1	00	00-3F (0 position character to 63rd character)	
	Number of characters for extraction[0]	0445	1	00	00-40 (0 characters to 64 characters)	If the setting value is 00, extraction is not performed.
	Number of characters for extraction[1]	0446	1	00	00-40 (0 characters to 64 characters)	
	Number of characters for extraction[2]	0447	1	00	00-40 (0 characters to 64 characters)	
	Number of characters for extraction[3]	0448	1	00	00-40 (0 characters to 64 characters)	
	Replacement character code	0449	1	00	00-FF: ASCII code	
	Reserved	044A-044F	6	-	-	
Comparison-Matching	Function enabled	0450	1	00	00: Disabled 01: Enabled	
	Reserved	0451	1	-	-	
	Reserved	0452	1	-	-	
	Reserved	0453	1	-	-	
	Number of area partitions	0454	1	04	04, 08, 10, 20, 40: Number of partitions (4, 8, 16, 32, 64 partitions)	
	Reserved	0455-045F	11	00	-	
	Reference data [0]-[255]	0460-055F	1	All 00	00-FF: ASCII code	









Item	Sub item	Address (hex)	Size (dec)	Default (hex)	Setting value (hex)	Remarks
Command alias	Function enabled	0560	1	00	00: Disabled 01: Enabled	
	Reserved	0561	1	-	-	
	Reserved	0562	1	-	-	
	Reserved	0563	1	-	-	
	Start barcode reading command[0]	0564	16	4C	00-FF: ASCII code	
		0565		4F	00-FF: ASCII code	
		0566		4E	00-FF: ASCII code	
		0567		0D	00-FF: ASCII code	
		0568		00	00-FF: ASCII code	
		0569		00	00-FF: ASCII code	
		056A		00	00-FF: ASCII code	
		056B		00	00-FF: ASCII code	
		056C		00	00-FF: ASCII code	
		056D		00	00-FF: ASCII code	
		056E		00	00-FF: ASCII code	
		056F		00	00-FF: ASCII code	
		0570		00	00-FF: ASCII code	
		0571		00	00-FF: ASCII code	
		0572		00	00-FF: ASCII code	
		0573		00	00-FF: ASCII code	
	Start barcode reading command[1]	0574	16	1B	00-FF: ASCII code	
		0575		5A	00-FF: ASCII code	
		0576		0D	00-FF: ASCII code	
		0577		00	00-FF: ASCII code	
		0578		00	00-FF: ASCII code	
		0579		00	00-FF: ASCII code	
		057A		00	00-FF: ASCII code	
		057B		00	00-FF: ASCII code	
		057C		00	00-FF: ASCII code	
		057D		00	00-FF: ASCII code	
		057E		00	00-FF: ASCII code	
		057F		00	00-FF: ASCII code	
		0580		00	00-FF: ASCII code	
		0581		00	00-FF: ASCII code	
		0582		00	00-FF: ASCII code	
		0583		00	00-FF: ASCII code	
	Start barcode reading command[2]	0584	16	47	00-FF: ASCII code	
		0585		00	00-FF: ASCII code	
		0586		00	00-FF: ASCII code	
		0587		00	00-FF: ASCII code	
		0588		00	00-FF: ASCII code	
		0589		00	00-FF: ASCII code	
058A		00		00-FF: ASCII code		
058B		00		00-FF: ASCII code		
058C		00		00-FF: ASCII code		
058D		00		00-FF: ASCII code		
058E		00		00-FF: ASCII code		
058F		00		00-FF: ASCII code		
0590		00		00-FF: ASCII code		
0591		00		00-FF: ASCII code		
0592		00		00-FF: ASCII code		
0593		00		00-FF: ASCII code		









Item	Sub item	Address (hex)	Size (dec)	Default (hex)	Setting value (hex)	Remarks
Command alias	Start barcode reading command[3]	0594	16	00	00-FF: ASCII code	
		0595		00	00-FF: ASCII code	
		0596		00	00-FF: ASCII code	
		0597		00	00-FF: ASCII code	
		0598		00	00-FF: ASCII code	
		0599		00	00-FF: ASCII code	
		059A		00	00-FF: ASCII code	
		059B		00	00-FF: ASCII code	
		059C		00	00-FF: ASCII code	
		059D		00	00-FF: ASCII code	
		059E		00	00-FF: ASCII code	
		059F		00	00-FF: ASCII code	
		05A0		00	00-FF: ASCII code	
		05A1		00	00-FF: ASCII code	
	05A2	00	00-FF: ASCII code			
	05A3	00	00-FF: ASCII code			
	Stop barcode reading command[0]	05A4	16	4C	00-FF: ASCII code	
		05A5		4F	00-FF: ASCII code	
		05A6		46	00-FF: ASCII code	
		05A7		46	00-FF: ASCII code	
		05A8		0D	00-FF: ASCII code	
		05A9		00	00-FF: ASCII code	
		05AA		00	00-FF: ASCII code	
		05AB		00	00-FF: ASCII code	
		05AC		00	00-FF: ASCII code	
		05AD		00	00-FF: ASCII code	
		05AE		00	00-FF: ASCII code	
	05AF	00	00-FF: ASCII code			
	05B0	00	00-FF: ASCII code			
	05B1	00	00-FF: ASCII code			
	05B2	00	00-FF: ASCII code			
	05B3	00	00-FF: ASCII code			
	Stop barcode reading command[1]	05B4	16	1B	00-FF: ASCII code	
05B5		59		00-FF: ASCII code		
05B6		0D		00-FF: ASCII code		
05B7		00		00-FF: ASCII code		
05B8		00		00-FF: ASCII code		
05B9		00		00-FF: ASCII code		
05BA		00		00-FF: ASCII code		
05BB		00		00-FF: ASCII code		
05BC		00		00-FF: ASCII code		
05BD		00		00-FF: ASCII code		
05BE		00		00-FF: ASCII code		
05BF		00		00-FF: ASCII code		
05C0	00	00-FF: ASCII code				
05C1	00	00-FF: ASCII code				
05C2	00	00-FF: ASCII code				
05C3	00	00-FF: ASCII code				





Item	Sub item	Address (hex)	Size (dec)	Default (hex)	Setting value (hex)	Remarks
Command alias	Stop barcode reading command[2]	05C4	16	53	00-FF: ASCII code	
		05C5		00	00-FF: ASCII code	
		05C6		00	00-FF: ASCII code	
		05C7		00	00-FF: ASCII code	
		05C8		00	00-FF: ASCII code	
		05C9		00	00-FF: ASCII code	
		05CA		00	00-FF: ASCII code	
		05CB		00	00-FF: ASCII code	
		05CC		00	00-FF: ASCII code	
		05CD		00	00-FF: ASCII code	
		05CE		00	00-FF: ASCII code	
		05CF		00	00-FF: ASCII code	
		05D0		00	00-FF: ASCII code	
		05D1		00	00-FF: ASCII code	
		05D2		00	00-FF: ASCII code	
		05D3		00	00-FF: ASCII code	
	Stop barcode reading command[3]	05D4	16	00	00-FF: ASCII code	
		05D5		00	00-FF: ASCII code	
		05D6		00	00-FF: ASCII code	
		05D7		00	00-FF: ASCII code	
		05D8		00	00-FF: ASCII code	
		05D9		00	00-FF: ASCII code	
		05DA		00	00-FF: ASCII code	
		05DB		00	00-FF: ASCII code	
		05DC		00	00-FF: ASCII code	
		05DD		00	00-FF: ASCII code	
		05DE		00	00-FF: ASCII code	
		05DF		00	00-FF: ASCII code	
		05E0		00	00-FF: ASCII code	
		05E1		00	00-FF: ASCII code	
	05E2	00	00-FF: ASCII code			
	05E3	00	00-FF: ASCII code			
	Reserved	05E4-05EF	12	-	-	
	Communication command Function	Reserved	05F0	1	-	
Check digit addition		05F1	1	00	00: Disabled 01: Enabled	Not applied to control command requests.
Uppercase response		05F2	1	00	00: Disabled (lowercase) 01: Enabled (uppercase)	You can select the notation for the hexadecimal data when there is a response.
Reserved		05F3	1	-	-	
Prefix		05F4	4	5E	00-FF: ASCII code	
		05F5		00	00-FF: ASCII code	
		05F6		00	00-FF: ASCII code	
		05F7		00	00-FF: ASCII code	
Suffix		05F8	4	0D	00-FF: ASCII code	
		05F9		0A	00-FF: ASCII code	
		05FA		00	00-FF: ASCII code	
	05FB	00		00-FF: ASCII code		
Reserved	05FC-069F	164	-	-		
Reserved	06A0-07FF	352	-	-		



Item	Sub item	Address (hex)	Size (dec)	Default (hex)	Setting value (hex)	Remarks
Algorithm setting	Automatic adjustment	0800	1	01	01: Automatic adjustment	Please use the default setting.
	Reserved	0801	1	-	-	
	Table choice	0802	1	00	00: Default	
	Reserved	0803-080F	13	-	-	
	Manual setting	0810	2	00	0000: Default	
	Reserved	0812-081F	12	-	-	
	Parameter 1-1	0820	2	00	0000: Default	
	Parameter 1-2	0822	2	00	0000: Default	
	Parameter 1-3	0824	2	00	0000: Default	
	Reserved	0826-082F	10	-	-	
	Parameter 2-1	0830	2	00	0000: Default	
Parameter 2-2	0832	2	00	0000: Default		
Reserved	0834-08FF	1293	-	-		
Decoder common	Right margin rate	0900	1	00	00: Normal 01-06: 1/7-6/7	For details, refer to P. 5-23 "5. 14 Setting margin rate" .
	Normal/reverse barcode reading setting	0901	1	00	00: Normal only 01: Reverse only 02: Both	
	Menu label reading	0902	1	01	00: Disabled 01: Enabled	
	Reserved	0903-090E	12	-	-	
	All symbology Reading allowed/prohibited	090F	1	*	00: All symbology reading prohibited 01: All symbology reading allowed	Reading allowed/prohibited setting values for all symbology decoder settings can be collectively overwritten. * When getting the setting values, FFH is always returned.
Decoder Code39	Reading allowed/prohibited	0910	1	01	00: Reading prohibited 01: Reading allowed	
	Label direction specified reading	0911	1	00	00: Not specified 01: Forward only 02: Reverse only	
	Inspection of check digit	0912	1	00	00: Disabled 01: Enabled	For details, refer to P. 5-20 "5. 13 Setting check digit" .
	Check digit sending	0913	1	01	00: Not send 01: Send	
	Left margin rate	0914	1	00	00: Normal 01-06: 1/7-6/7	For details, refer to P. 5-23 "5. 14 Setting margin rate" .
	Reserved	0915	1	-	-	
	Start/stop character sending	0916	1	00	00: Disabled 01: Enabled	
	Reserved	0917	1	-	-	
	Full ASCII decode	0918	1	00	00: Not convert 01: Convert 02: Not read anything other than full ASCII	
	Reserved	0919-091D	5	-	-	
	Fixed length A	091E	1	02	01-40 (1 digit to 64 digits)	For details, refer to P. 3-60 "Methods to fix the length of read barcodes" .
Fixed length B	091F	1	40	01-40 (1 digit to 64 digits)		





Item	Sub item	Address (hex)	Size (dec)	Default (hex)	Setting value (hex)	Remarks
Decoder Codabar (NW7)	Reading allowed/ prohibited	0920	1	01	00: Reading prohibited 01: Reading allowed	
	Label direction specified reading	0921	1	00	00: Not specified 01: Forward only 02: Reverse only	
	Inspection of check digit	0922	1	00	00: Disabled 01: Enabled	For details, refer to  P. 5-20 "5. 13 Setting check digit".
	Check digit sending	0923	1	01	00: Not send 01: Send	
	Left margin rate	0924	1	00	00: Normal 01-06: 1/7-6/7	For details, refer to  P. 5-23 "5. 14 Setting margin rate".
	Reserved	0925	1	-	-	
	Start/stop character sending	0926	1	01	00: Disabled 01: Enabled	
	Reserved	0927	1	-	-	
	Start/stop type	0928	1	00	00: ABCD/ABCD 01: abcd/abcd 02: ABCD/TN*E 03: abcd/tn*e 04: DC1-4/DC1-4	
	Start/stop identical check	0929	1	00	00: Disabled 01: Enabled	
Decoder Codabar (NW7)	Check digit type selection	092A	1	00	00: Modulus 16 (AIM compliant) 01: Modulus 11 weight pattern 1 02: Modulus 11 weight pattern 2 03: Modulus 10 weight 1, 2 04: Modulus 10 weight 1, 2 (Luhn) 05: Modulus 10 weight 3 06: 7Check	
	CLSI editing	092B	1	00	00: Disabled 01: Enabled	
	Reserved	092C	1	-	-	
	Reserved	092D	1	-	-	
	Fixed length A	092E	1	04	01-40 (1 digit to 64 digits)	For details, refer to  P. 3-60 "Methods to fix the length of read barcodes".
	Fixed length B	092F	1	40	01-40 (1 digit to 64 digits)	









Item	Sub item	Address (hex)	Size (dec)	Default (hex)	Setting value (hex)	Remarks
Decoder Interleaved 2of5	Reading allowed/prohibited	0930	1	01	00: Reading prohibited 01: Reading allowed	
	Label direction specified reading	0931	1	00	00: Not specified 01: Forward only 02: Reverse only	
	Inspection of check digit	0932	1	00	00: Disabled 01: Enabled	For details, refer to  P. 5-20 "5. 13 Setting check digit".
		0933	1	01	00: Not send 01: Send	
	Left margin rate	0934	1	00	00: Normal 01-06: 1/7-6/7	For details, refer to  P. 5-23 "5. 14 Setting margin rate".
	Reserved	0935-0939	5	-	-	
	Check digit type selection	093A	1	00	00: USS 01: OPCC	
	EAN-13 conversion	093B	1	00	00: Disabled 01: Enabled	
	Reserved	093C	1	-	-	
	Reserved	093D	1	-	-	
	Fixed length A	093E	1	06	01-40 (1 digit to 64 digits)	For details, refer to  P. 3-60 "Methods to fix the length of read barcodes".
	Fixed length B	093F	1	40	01-40 (1 digit to 64 digits)	
Decoder Standard 2of5	Reading allowed/prohibited	0940	1	01	00: Reading prohibited 01: Reading allowed	
	Label direction specified reading	0941	1	00	00: Not specified 01: Forward only 02: Reverse only	
	Inspection of check digit	0942	1	00	00: Disabled 01: Enabled	For details, refer to  P. 5-20 "5. 13 Setting check digit".
		0943	1	01	00: Not send 01: Send	
	Left margin rate	0944	1	00	00: Normal 01-06: 1/7-6/7	For details, refer to  P. 5-23 "5. 14 Setting margin rate".
	Reserved	0945	1	-	-	
	Reserved	0946	1	-	-	
	Inter-character gap check	0947	1	00	00: Disabled 01: Enabled	
	Reserved	0948-094D	6	-	-	
	Fixed length A	094E	1	05	01-40 (1 digit to 64 digits)	For details, refer to  P. 3-60 "Methods to fix the length of read barcodes".
	Fixed length B	094F	1	40	01-40 (1 digit to 64 digits)	
	Decoder Matrix 2of5	Reading allowed/prohibited	0950	1	01	00: Reading prohibited 01: Reading allowed
Label direction specified reading		0951	1	00	00: Not specified 01: Forward only 02: Reverse only	
Inspection of check digit		0952	1	00	00: Disabled 01: Enabled	For details, refer to  P. 5-20 "5. 13 Setting check digit".
		0953	1	01	00: Not send 01: Send	
Left margin rate		0954	1	00	00: Normal 01-06: 1/7-6/7	For details, refer to  P. 5-23 "5. 14 Setting margin rate".
Reserved		0955-095D	9	-	-	
Fixed length A		095E	1	05	01-40 (1 digit to 64 digits)	For details, refer to  P. 3-60 "Methods to fix the length of read barcodes".
Fixed length B		095F	1	7F	01-40 (1 digit to 64 digits)	





Item	Sub item	Address (hex)	Size (dec)	Default (hex)	Setting value (hex)	Remarks
Decoder IATA 2of5	Reading allowed/prohibited	0960	1	00	00: Reading prohibited 01: Reading allowed	
	Label direction specified reading	0961	1	00	00: Not specified 01: Forward only 02: Reverse only	
	Inspection of check digit	0962	1	00	00: Disabled 01: Enabled	For details, refer to  P. 5-20 "5. 13 Setting check digit".
	Check digit sending	0963	1	01	00: Not send 01: Send	
	Left margin rate	0964	1	00	00: Normal 01-06: 1/7-6/7	For details, refer to  P. 5-23 "5. 14 Setting margin rate".
	Reserved	0965-096D	9	-	-	
	Fixed length A	096E	1	05	01-40 (1 digit to 64 digits)	For details, refer to  P. 3-60 "Methods to fix the length of read barcodes".
	Fixed length B	096F	1	40	01-40 (1 digit to 64 digits)	
Decoder Coop 2of5	Reading allowed/prohibited	0970	1	00	00: Reading prohibited 01: Reading allowed	
	Label direction specified reading	0971	1	00	00: Not specified 01: Forward only 02: Reverse only	
	Inspection of check digit	0972	1	00	00: Disabled 01: Enabled	For details, refer to  P. 5-20 "5. 13 Setting check digit".
	Check digit sending	0973	1	01	00: Not send 01: Send	
	Left margin rate	0974	1	00	00: Normal 01-06: 1/7-6/7	For details, refer to  P. 5-23 "5. 14 Setting margin rate".
	Reserved	0975-097D	9	-	-	
	Fixed length A	097E	1	04	01-40 (1 digit to 64 digits)	For details, refer to  P. 3-60 "Methods to fix the length of read barcodes".
	Fixed length B	097F	1	40	01-40 (1 digit to 64 digits)	
Decoder Scode	Reading allowed/prohibited	0980	1	00	00: Reading prohibited 01: Reading allowed	
	Label direction specified reading	0981	1	00	00: Not specified 01: Forward only 02: Reverse only	
	Inspection of check digit	0982	1	00	00: Disabled 01: Enabled	For details, refer to  P. 5-20 "5. 13 Setting check digit".
	Check digit sending	0983	1	01	00: Not send 01: Send	
	Left margin rate	0984	1	00	00: Normal 01-06: 1/7-6/7	For details, refer to  P. 5-23 "5. 14 Setting margin rate".
	Reserved	0985-098C	8	-	-	
	Interleaved 2of5 format conversion	098D	1	00	00: Disabled 01: Enabled	
	Fixed length A	098E	1	02	01-40 (1 digit to 64 digits)	For details, refer to  P. 3-60 "Methods to fix the length of read barcodes".
	Fixed length B	098F	1	40	01-40 (1 digit to 64 digits)	



Item	Sub item	Address (hex)	Size (dec)	Default (hex)	Setting value (hex)	Remarks
Decoder Chinese Post Matrix	Reading allowed/ prohibited	0990	1	00	00: Reading prohibited 01: Reading allowed	
	Label direction specified reading	0991	1	00	00: Not specified 01: Forward only 02: Reverse only	
	Inspection of check digit	0992	1	00	00: Disabled 01: Enabled	For details, refer to  P. 5-20 "5. 13 Setting check digit".
	Check digit sending	0993	1	01	00: Not send 01: Send	
	Left margin rate	0994	1	00	00: Normal 01-06: 1/7-6/7	For details, refer to  P. 5-23 "5. 14 Setting margin rate".
	Reserved	0995-099D	9	-	-	
	Fixed length A	099E	1	05	01-40 (1 digit to 64 digits)	For details, refer to  P. 3-60 "Methods to fix the length of read barcodes".
	Fixed length B	099F	1	40	01-40 (1 digit to 64 digits)	
Decoder UPC-A	Reading allowed/ prohibited	09A0	1	01	00: Reading prohibited 01: Reading allowed	
	Label direction specified reading	09A1	1	00	00: Not specified 01: Forward only 02: Reverse only	
	Inspection of check digit	09A2	1	01	00: Disabled 01: Enabled	For details, refer to  P. 5-20 "5. 13 Setting check digit".
	Check digit sending	09A3	1	01	00: Not send 01: Send	
	Left margin rate	09A4	1	00	00: Normal 01-06: 1/7-6/7	For details, refer to  P. 5-23 "5. 14 Setting margin rate".
	Reserved	09A5	1	-	-	
	Reading with supplement	09A6	1	00	00: Prohibited 01: 2 digits only 02: 5 digits only 03: 2 digits/5 digits	
	Sending "0" at the beginning	09A7	1	01	00: Not send 01: Send	
	EAN-13 conversion	09A8	1	00	00: Disabled 01: Enabled	
	Reserved	09A9-09AF	7	-	-	





Item	Sub item	Address (hex)	Size (dec)	Default (hex)	Setting value (hex)	Remarks
Decoder UPC-E0	Reading allowed/ prohibited	09B0	1	01	00: Reading prohibited 01: Reading allowed	
	Label direction specified reading	09B1	1	00	00: Not specified 01: Forward only 02: Reverse only	
	Inspection of check digit	09B2	1	01	00: Disabled 01: Enabled	For details, refer to  P. 5-20 "5. 13 Setting check digit".
	Check digit sending	09B3	1	01	00: Not send 01: Send	
	Left margin rate	09B4	1	00	00: Normal 01-06: 1/7-6/7	<ul style="list-style-type: none"> • This setting is shared with UPC-E1. • For details, refer to  P. 5-23 "5. 14 Setting margin rate".
	Reserved	09B5	1	-	-	
	Reading with supplement	09B6	1	00	00: Prohibited 01: 2 digits only 02: 5 digits only 03: 2 digits/5 digits	
	Number system characters	09B7	1	01	00: Not send 01: Send	
	EAN-13 conversion	09B8	1	00	00: Disabled 01: Enabled	
	UPC-A conversion	09B9	1	00	00: Disabled 01: Enabled	
	Reserved	09BA	1	-	-	Old: Country code characters addition (Please don't use.)
	Reserved	09BB-09BF	5	-	-	
Decoder UPC-E1	Reading allowed/ prohibited	09C0	1	01	00: Reading prohibited 01: Reading allowed	
	Label direction specified reading	09C1	1	00	00: Not specified 01: Forward only 02: Reverse only	
	Inspection of check digit	09C2	1	01	00: Disabled 01: Enabled	For details, refer to  P. 5-20 "5. 13 Setting check digit".
	Check digit sending	09C3	1	01	00: Not send 01: Send	
	Reserved	09C4	1	-	-	The "left margin rate" is shared with UPC-E0.
	Reserved	09C5	1	-	-	
	Reading with supplement	09C6	1	00	00: Prohibited 01: 2 digits only 02: 5 digits only 03: 2 digits/5 digits	
	Number system characters	09C7	1	01	00: Not Send 01: Send	
	EAN-13 conversion	09C8	1	00	00: Disabled 01: Enabled	
	UPC-A conversion	09C9	1	00	00: Disabled 01: Enabled	
	Reserved	09CA	1	-	-	Old: Country code characters addition (Please don't use.)
	Reserved	09CB-09CF	5	-	-	

Item	Sub item	Address (hex)	Size (dec)	Default (hex)	Setting value (hex)	Remarks
Decoder EAN-13	Reading allowed/prohibited	09D0	1	01	00: Reading prohibited 01: Reading allowed	
	Label direction specified reading	09D1	1	00	00: Not specified 01: Forward only 02: Reverse only	
	Inspection of check digit	09D2	1	01	00: Disabled 01: Enabled	For details, refer to  P. 5-20 "5. 13 Setting check digit".
	Check digit sending	09D3	1	01	00: Not send 01: Send	
	Left margin rate	09D4	1	00	00: Normal 01-06: 1/7-6/7	For details, refer to  P. 5-23 "5. 14 Setting margin rate".
	Reserved	09D5	1	-	-	
	Reading with supplement	09D6	1	00	00: Prohibited 01: 2 digits only 02: 5 digits only 03: 2 digits/5 digits	
	Active supplement/Japan 491: (periodical code)	09D7	1	00	00: Disabled 01: Enabled	
	Active supplement/ISSN 977	09D8	1	00	00: Disabled 01: Enabled	
	Active supplement/bookland 978,979	09D9	1	00	00: Disabled 01: Enabled	
	Active supplement/France 378/379	09DA	1	00	00: Disabled 01: Enabled	
Active supplement/Germany 414,419,434, 439	09DB	1	00	00: Disabled 01: Enabled		
Decoder EAN-13	ISBN option	09DC	1	00	00: Disabled 01: Read only ISBN 02: Output all including non-ISBN	
	ISSN option	09DD	1	00	00: Disabled 01: Read only ISSN 02: Output all including non-ISSN	
	ISMN option	09DE	1	00	00: Disabled 01: Read only ISBM 02: Output all including non-ISBM	
	Reserved	09DF	1	-	-	
Decoder EAN-8	Reading allowed/prohibited	09E0	1	01	00: Reading prohibited 01: Reading allowed	
	Label direction specified reading	09E1	1	00	00: Not specified 01: Forward only 02: Reverse only	
	Inspection of check digit	09E2	1	01	00: Disabled 01: Enabled	For details, refer to  P. 5-20 "5. 13 Setting check digit".
	Check digit sending	09E3	1	01	00: Not send 01: Send	
	Left margin rate	09E4	1	00	00: Normal 01-06: 1/7-6/7	For details, refer to  P. 5-23 "5. 14 Setting margin rate".
	Reserved	09E5	1	-	-	
	Reading with supplement	09E6	1	00	00: Prohibited 01: 2 digits only 02: 5 digits only 03: 2 digits/5 digits	
	EAN-13 conversion output	09E7	1	00	00: Disabled 01: Enabled	
	Reserved	09E8-09EF	8	-	-	

Item	Sub item	Address (hex)	Size (dec)	Default (hex)	Setting value (hex)	Remarks
Decoder Code128	Reading allowed/prohibited	09F0	1	01	00: Reading prohibited 01: Reading allowed	
	Label direction specified reading	09F1	1	00	00: Not specified 01: Forward only 02: Reverse only	
	Inspection of check digit	09F2	1	01	00: Disabled 01: Enabled	For details, refer to  P. 5-20 "5. 13 Setting check digit".
	Reserved	09F3	1	-	-	
	Left margin rate	09F4	1	00	00: Normal 01-06: 1/7-6/7	For details, refer to  P. 5-23 "5. 14 Setting margin rate".
	Reserved	09F5-09FD	9	-	-	
	Fixed length A	09FE	1	01	01-40 (1 digit to 64 digits)	For details, refer to  P. 3-60 "Methods to fix the length of read barcodes".
	Fixed length B	09FF	1	40	01-40 (1 digit to 64 digits)	
Decoder GS1-128	Reading allowed/prohibited	0A00	1	00	00: Reading prohibited 01: Reading allowed	
	Label direction specified reading	0A01	1	00	00: Not specified 01: Forward only 02: Reverse only	
	Output mode	0A02	1	00	00: Normal 01: AI recognition mode	
	FNC1/GS conversion	0A03	1	01	00: Disabled 01: Enabled	
	AI output	0A04	1	01	00: Disabled 01: Enabled (AI recognition mode)	For details, refer to  P. 5-15 "5. 9 GS1-128 Application Identifier".
	AI parenthesis additional output	0A05	1	00	00: Disabled 01: Enabled (AI recognition mode)	
	Date data zero suppression	0A06	1	00	00: Disabled 01: Enabled (AI recognition mode)	
	Decimal point insertion	0A07	1	00	00: Disabled 01: Enabled (AI recognition mode)	
	Reserved	0A08-0A0D	6	-	-	
	Fixed length A	0A0E	1	03	01-40 (1 digit to 64 digits)	For details, refer to  P. 3-60 "Methods to fix the length of read barcodes".
	Fixed length B	0A0F	1	40	01-40 (1 digit to 64 digits)	
Decoder Code93	Reading allowed/prohibited	0A10	1	01	00: Reading prohibited 01: Reading allowed	
	Label direction specified reading	0A11	1	00	00: Not specified 01: Forward only 02: Reverse only	
	Inspection of check digit	0A12	1	01	00: Disabled 01: Enabled	For details, refer to  P. 5-20 "5. 13 Setting check digit".
	Reserved	0A13	1	-	-	
	Left margin rate	0A14	1	00	00: Normal 01-06: 1/7-6/7	For details, refer to  P. 5-23 "5. 14 Setting margin rate".
	Reserved	0A15-0A1D	9	-	-	
	Fixed length A	0A1E	1	01	01-40 (1 digit to 64 digits)	For details, refer to  P. 3-60 "Methods to fix the length of read barcodes".
	Fixed length B	0A1F	1	40	01-40 (1 digit to 64 digits)	

Item	Sub item	Address (hex)	Size (dec)	Default (hex)	Setting value (hex)	Remarks
Decoder MSI/Plessey	Reading allowed/ prohibited	0A20	1	00	00: Reading prohibited 01: Reading allowed	
	Label direction specified reading	0A21	1	00	00: Not specified 01: Forward only 02: Reverse only	
	Inspection of check digit Check digit sending	0A22	1	00	00: Disabled 01: Enabled	For details, refer to  P. 5-20 "5. 13 Setting check digit".
		0A23	1	02	00: Not send 01: Send 1 digits 02: Send 2 digits	
	Left margin rate	0A24	1	00	00: Normal 01-06: 1/7-6/7	For details, refer to  P. 5-23 "5. 14 Setting margin rate".
	Reserved	0A25-0A29	5	-	-	
	Check digit type selection	0A2A	1	00	00: MOD10 01: MOD10+MOD10 02: MOD10+MOD11 03: MOD11+MOD10	
	Reserved	0A2B	1	-	-	
	Reserved	0A2C	1	-	-	
	Reserved	0A2D	1	-	-	
	Fixed length A	0A2E	1	03	01-40 (1 digit to 64 digits)	For details, refer to  P. 3-60 "Methods to fix the length of read barcodes".
Fixed length B	0A2F	1	40	01-40 (1 digit to 64 digits)		
Decoder Italian Pharm (Code32)	Reading allowed/ prohibited	0A30	1	00	00: Reading prohibited 01: Reading allowed	
	Label direction specified reading	0A31	1	00	00: Not specified 01: Forward only 02: Reverse only	
	Inspection of check digit	0A32	1	00	00: Disabled 01: Enabled	For details, refer to  P. 5-20 "5. 13 Setting check digit".
	Check digit sending	0A33	1	01	00: Not send 01: Send	
	Reserved	0A34	1	-	-	
	Add prefix A	0A35	1	00	00: Disabled 01: Enabled	
	Reserved	0A36-0A3F	10	-	-	
Decoder CIP39	Reading allowed/ prohibited	0A40	1	00	00: Reading prohibited 01: Reading allowed	
	Label direction specified reading	0A41	1	00	00: Not specified 01: Forward only 02: Reverse only	
	Inspection of check digit	0A42	1	00	00: Disabled 01: Enabled	For details, refer to  P. 5-20 "5. 13 Setting check digit".
	Check digit sending	0A43	1	01	00: Not send 01: Send	
	Reserved	0A44	1	-	-	
	Reserved	0A45	1	-	-	
	Start/stop character sending	0A46	1	00	00: Not send 01: Send	
	Reserved	0A47-0A4F	9	-	-	

Item	Sub item	Address (hex)	Size (dec)	Default (hex)	Setting value (hex)	Remarks
Decoder Tri-Optic	Reading allowed/ prohibited	0A50	1	00	00: Reading prohibited 01: Reading allowed	
	Label direction specified reading	0A51	1	00	00: Not specified 01: Forward only 02: Reverse only	
	Reserved	0A52	1	-	-	
	Reserved	0A53	1	-	-	
	Reserved	0A54	1	-	-	
	Reserved	0A55	1	-	-	
	Start/stop character sending	0A56	1	00	00: Not send 01: Send	
	Reserved	0A57-0A5F	9	-	-	
Decoder TELEPEN	Reading allowed/ prohibited	0A60	1	00	00: Reading prohibited 01: Reading allowed	
	Label direction specified reading	0A61	1	00	00: Not specified 01: Forward only 02: Reverse only	
	Inspection of check digit	0A62	1	01	00: Disabled 01: Enabled	For details, refer to  P. 5-20 "5. 13 Setting check digit".
	Check digit sending	0A63	1	00	00: Not send 01: Send	
	Reserved	0A64	1	-	-	
	Reserved	0A65	1	-	-	
	Reserved	0A66	1	-	-	
	ASCII mode	0A67	1	00	00: Disabled 01: Enabled	
	Reserved	0A68	1	-	-	
	VTF conversion	0A69	1	00	00: Disabled 01: Enabled	
	SISO conversion	0A6A	1	00	00: Disabled 01: Enabled	
	Reserved	0A6B	1	-	-	
	Reserved	0A6C	1	-	-	
	Reserved	0A6D	1	-	-	
	Fixed length A	0A6E	1	03	01-40 (1 digit to 64 digits)	For details, refer to  P. 3-60 "Methods to fix the length of read barcodes".
	Fixed length B	0A6F	1	1E	01-40 (1 digit to 64 digits)	

Item	Sub item	Address (hex)	Size (dec)	Default (hex)	Setting value (hex)	Remarks
Decoder Code11	Reading allowed/prohibited	0A70	1	00	00: Reading prohibited 01: Reading allowed	
	Label direction specified reading	0A71	1	00	00: Not specified 01: Forward only 02: Reverse only	
	Inspection of check digit	0A72	1	01	00: Disabled 01: Enabled	For details, refer to  P. 5-20 "5. 13 Setting check digit".
	Check digit sending	0A73	1	01	00: Not send 01: Send	
	Left margin rate	0A74	1	00	00: Normal 01-06: 1/7-6/7	For details, refer to  P. 5-23 "5. 14 Setting margin rate".
	Reserved	0A75-0A79	5	-	-	
	Check digit type selection	0A7A	1	00	00: Auto: Less than 10 characters TypeC 01: TypeC (1 digit) 02: TypeK (1 digit) 03: TypeC+K	
	Reserved	0A7B	1	-	-	
	Reserved	0A7C	1	-	-	
	Reserved	0A7D	1	-	-	
	Fixed length A	0A7E	1	02	01-40 (1 digit to 64 digits)	For details, refer to  P. 3-60 "Methods to fix the length of read barcodes".
	Fixed length B	0A7F	1	40	01-40 (1 digit to 64 digits)	
Decoder GS1 Databar Expanded	Reading allowed/prohibited	0A80	1	00	00: Reading prohibited 01: Reading allowed	
	Label direction specified reading	0A81	1	00	00: Not specified 01: Forward only 02: Reverse only	
	Reserved	0A82-0A8D	12	-	-	
	Fixed length A	0A8E	1	01	01-40 (1 digit to 64 digits)	For details, refer to  P. 3-60 "Methods to fix the length of read barcodes".
	Fixed length B	0A8F	1	40	01-40 (1 digit to 64 digits)	
Decoder GS1 Databar Limited	Reading allowed/prohibited	0A90	1	00	00: Reading prohibited 01: Reading allowed	
	Label direction specified reading	0A91	1	00	00: Not specified 01: Forward only 02: Reverse only	
	Reserved	0A92	1	-	-	
	Reserved	0A93	1	-	-	
	AI output	0A94	1	01	00: Disabled 01: Enabled	
	Reserved	0A95-0A9F	11	-	-	
Decoder GS1 Databar Omni-directional	Reading allowed/prohibited	0AA0	1	00	00: Reading prohibited 01: Reading allowed	
	Label direction specified reading	0AA1	1	00	00: Not specified 01: Forward only 02: Reverse only	
	Reserved	0AA2	1	-	-	
	Reserved	0AA3	1	-	-	
	AI output	0AA4	1	01	00: Disabled 01: Enabled	
	Reserved	0AA5-0AAF	11	-	-	
Reserved	0AB0-FFFF	62800	-	-		

Methods to fix the length of read barcodes

For barcodes where a fixed length is possible, there are the "fixed length A" and "fixed length B" settings. There are three methods to fix the length.

Fixed length method	Configuration method	Readable length
Specify range	Fixed length A < fixed length B	Fixed length A to fixed length B
Specify fixed length	Fixed length A ≥ fixed length B	Fixed length A, fixed length B
Not specified	Fixed length A = 00H	1 digit to 64 digits

■ Specify range

You can specify a range for the length by setting the minimum barcode length to read for fixed length A and setting the maximum for fixed length B (fixed length A < fixed length B). However, do not set fixed length A as "00H". A range cannot be specified in that way.

Example: When fixed length A is set to "02H" and fixed length B is set to "08H"

A barcode of a length of 2 to 8 digits can be read because fixed length A < fixed length B.

■ Specify fixed length

If the setting value for fixed length A is larger than that of fixed length B (fixed length A > fixed length B), two types of fixed lengths can be set. If fixed length B is "00H", only the length set by fixed length A can be read.

If fixed length A and fixed length B are set to the same value (fixed length A=fixed length B), only the fixed length that has been set can be read.

Example: When fixed length A is set to "08H" and fixed length B is set to "02H"

A barcode of a length of 2 digits or 8 digits can be read because fixed length A > fixed length B.

Example: When fixed length A is set to "05H" and fixed length B is set to "05H"

Only a barcode of a length of 5 digits can be read because fixed length A = fixed length B.

■ Not specified fixed length

If fixed length A is set to "00H", length is not fixed. A barcode of a length of 1 to 64 digits can be read.

Example: When fixed length A is set to "00H"

A barcode of a length of 1 to 64 digits can be read because fixed length A = 00H.

The factory default setting is a specified length range that defines the minimum length. The factory default fixed length settings are as follows.

Barcode type	Fixed length A (Minimum length)	Fixed length B (Maximum length)	Comments	
Code39	2	64	Not including the start/stop character.	
Codabar (NW7)	4		Not including the start/stop character.	
Interleaved 2of5	6			
Standard 2of5	5			
Matrix 2of5	5			
IATA 2of5	5			
Coop 2of5	4			
Scode	2			
Chinese Post Matrix	5			
Code128	1			
GS1-128	3			Not including FNC1.
Code93	1			
MSI/Plessey	3			
TELEPEN	3	30	The length in NUMERIC mode is 1/2. Not including the CD digit.	
Code11	2	64	Includes the CD digit.	
GS1 Databar Expanded	1			

4 Support tool

This chapter describes the WB1F support tool.

4.1 Overview

RS-232 Type **USB Type**

The WB1F support tool is a Windows application that can easily configure and check operation of the WB1F. To use the WB1F support tool, please download the latest version from the IDEC website. For details on the WB1F support tool, refer to the included documentation.

5 Appendix

This chapter describes WB1F specifications, troubleshooting, and contains lists of codes.

5.1 Product specifications

RS-232 Type USB Type

Model	WB1F-100S1B	WB1F-100S1S
Rated power supply voltage	5V DC ± 0.25 V ^{*3}	USB bus power (5V DC)
Consumption current	200 mA or lower (peak 350 mA or lower)	
Operation button	Equipped on unit (tactile switch) x 1	
Reading distance	35 \pm 10 mm ^{*1}	
Reading width	80 mm (reading distance 35 mm) ^{*1}	
Number of digits to be read	64 digits max	
PCS	0.45 or higher (White reflectance 75% or higher) ^{*2}	
Minimum resolution	0.127 mm	
Light source	Red LED ($\lambda_p=630$ nm)	
Reading method	Linear CCD image sensor (2,500 pixels)	
Reading confirmation	OK output, NG output, PWM output, indicator LED x 3	
Number of scans	500 scans/second	
Communication interface	RS-232 (600 to 115,200 bps)	USB 2.0 full-speed 12 Mbps (virtual COM)
Connection type	Loose wires+shield 1 m, 10CxAWG30 shielded cable	USB connector Type A 1 m, 2PxAWG28 shielded cable
External trigger input	1 circuit Non-voltage contact (L active) Voltage input (VIL: 0V-1.0V, VIH: 4.0 V-VCC)	None
OK output, NG output PWM output	1 circuit each (3 circuits total) Open collector (sink) Maximum rating 26.4 V, 100 mA	None
Dielectric strength	500 VAC (live part-dead part, 1 minute)	
Anti-ESD	Contact ± 6 kV, air ± 8 kV (IEC 61000-4-2)	
Ambient usage temperature	0 to 40°C (no freezing)	
Ambient usage humidity	30 to 85%RH (no condensation)	
Ambient usage illumination	5,000 lx or lower (under incandescent light)	
Ambient storage temperature	-20 to +60°C (no freezing)	
Weight	Approx. 50 g (in packaging: approx. 100 g)	
Protective construction	IP40	
Certified standards	UL/c-UL Recognized ^{*3}	UL/c-UL Listing
	CE mark (EMC directive self-declared), VCCI (compliance confirmed), FCC (Verification), ICES-003 Class B (self-declared)	
Codes to be read	EAN-13/8 (including addon), UPC-A/E/E1 (including addon), Code39, Codabar (=NW7), Interleaved 2of5 (=ITF), Standard 2of5 (=Industrial 2of5), Matrix 2of5, IATA 2of5, Chinese Post Matrix, COOP 2of5, SCODE, Code93, Code128, GS1-128 (formerly: EAN-128), MSI/Plessey, Italian Pharmacy (Code32), CIP39, Tri-Optic, TELEPEN, Code11, GS1 Databar (formerly: RSS) ^{*4}	

*1 By IDEC standard barcode (symbol: EAN-13, resolution: 0.33 mm, PCS: 0.9)

*2 By IDEC standard barcode (symbol: EAN-13, resolution: 0.33 mm)

*3 If you use the WB1F as UL Recognized product, you shall use a limited source or class 2 power source as a power supply.

*4 Omni-directional, Truncated, Limited, Expanded

5.2 Field of view/characteristics

RS-232 Type

USB Type

5.2.1 Field of view

Resolution	Reading distance	Maximum reading width in focal point
From 0.127 mm	35 mm ± 5 mm	60 mm
0.19 mm ± 1.00 mm	35 mm ± 10 mm	80 mm

Measurement conditions

Pitch: 0°

Skew: 0°

Tilt: 0°

Using IDEC standard barcode

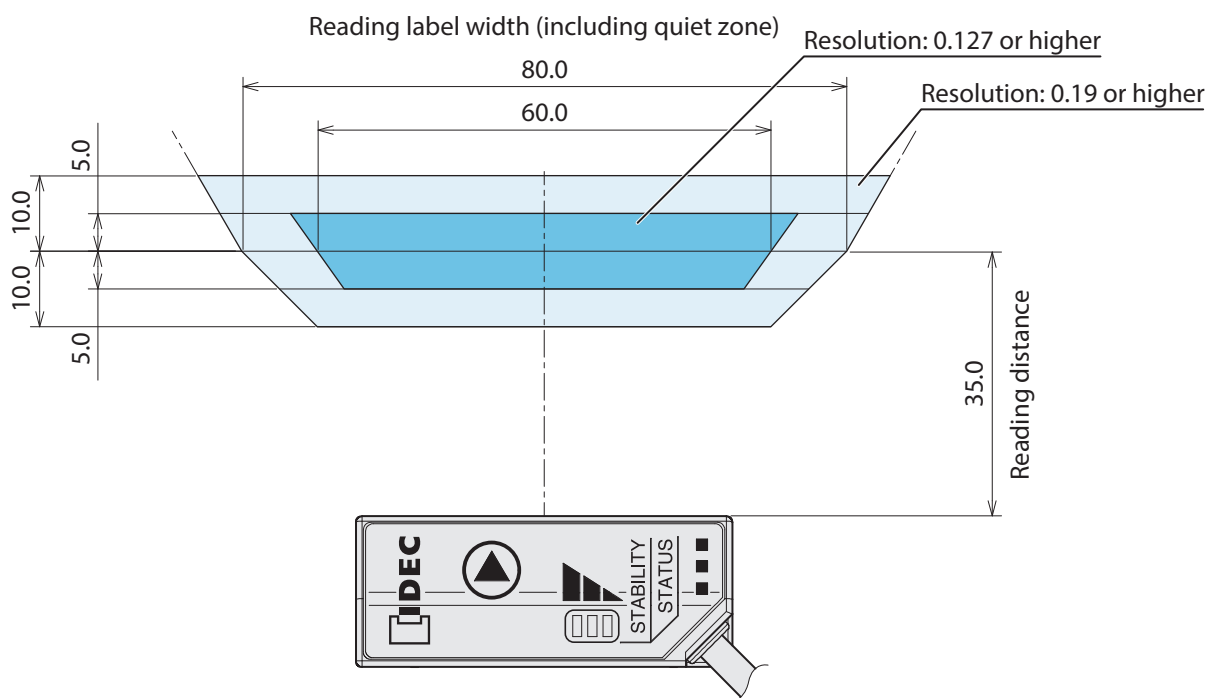

Unit: mm



- Depending on the barcode quality, the specification range may not be satisfied.
- The specification may be changed without prior notification for the purpose of product improvements.



- Use setup support mode to install the unit in the optimal reading position.
- The reading label width is the width that includes the quiet zone added before and after the barcode.

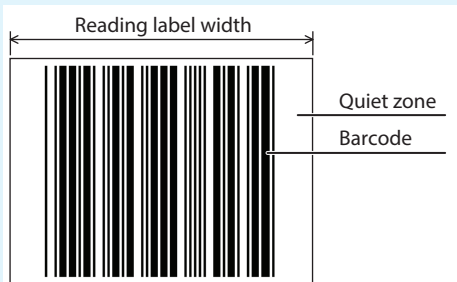

5.2.2 Angular characteristics

Pitch	Skew	Tilt
$-15^\circ \leq \theta \leq +15^\circ$	$-20^\circ \leq \theta \leq 0^\circ, +20^\circ \leq \theta \leq +40^\circ$	$-10^\circ \leq \theta \leq +10^\circ$

Measurement conditions

Reading distance: 35 mm

Using IDEC standard barcode

■ Pitch

Tilting to the left or right is $-15^\circ \leq \theta \leq +15^\circ$

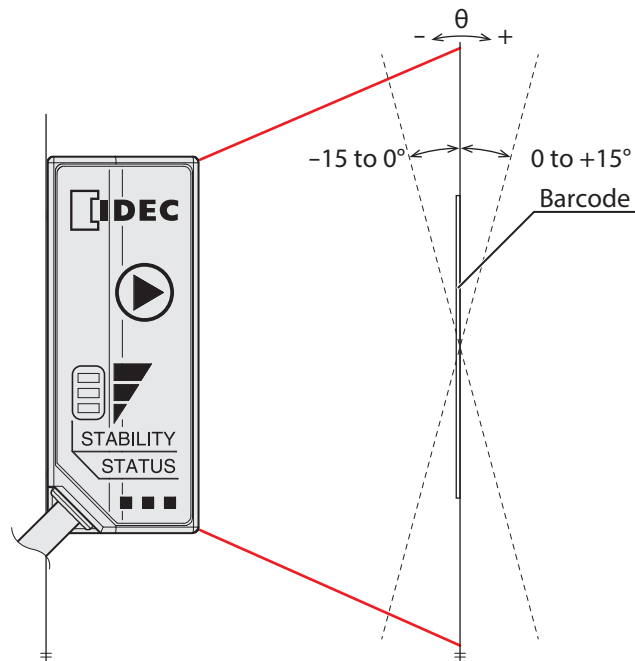

■ Skew

Tilting forward or backward is $-20^\circ \leq \theta \leq 0^\circ, +20^\circ \leq \theta \leq +40^\circ$

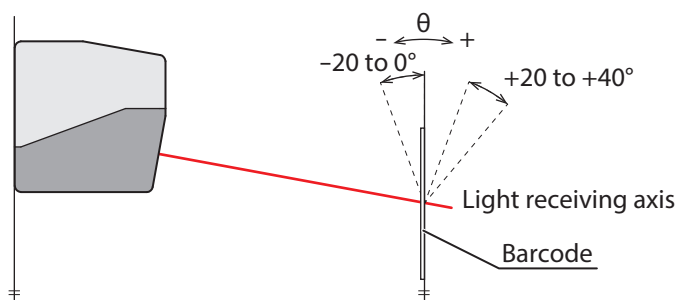

- Do not read barcodes in the skew range $0^\circ < \theta < 20^\circ$.
- Skew in a range of $0^\circ < \theta < 20^\circ$ is in the mirror reflection area (dead zone), so reading performance may drastically decrease in ways such as the unit not being able to read or misreading barcodes.

■ Tilt

Rotational angle $-10^\circ \leq \theta \leq +10^\circ$

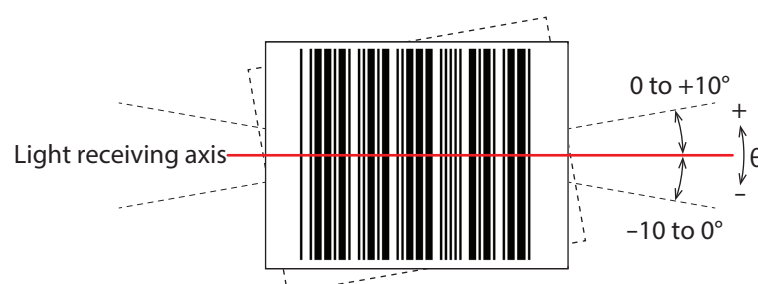

5.3 Dimensional outline drawings

RS-232 Type

USB Type

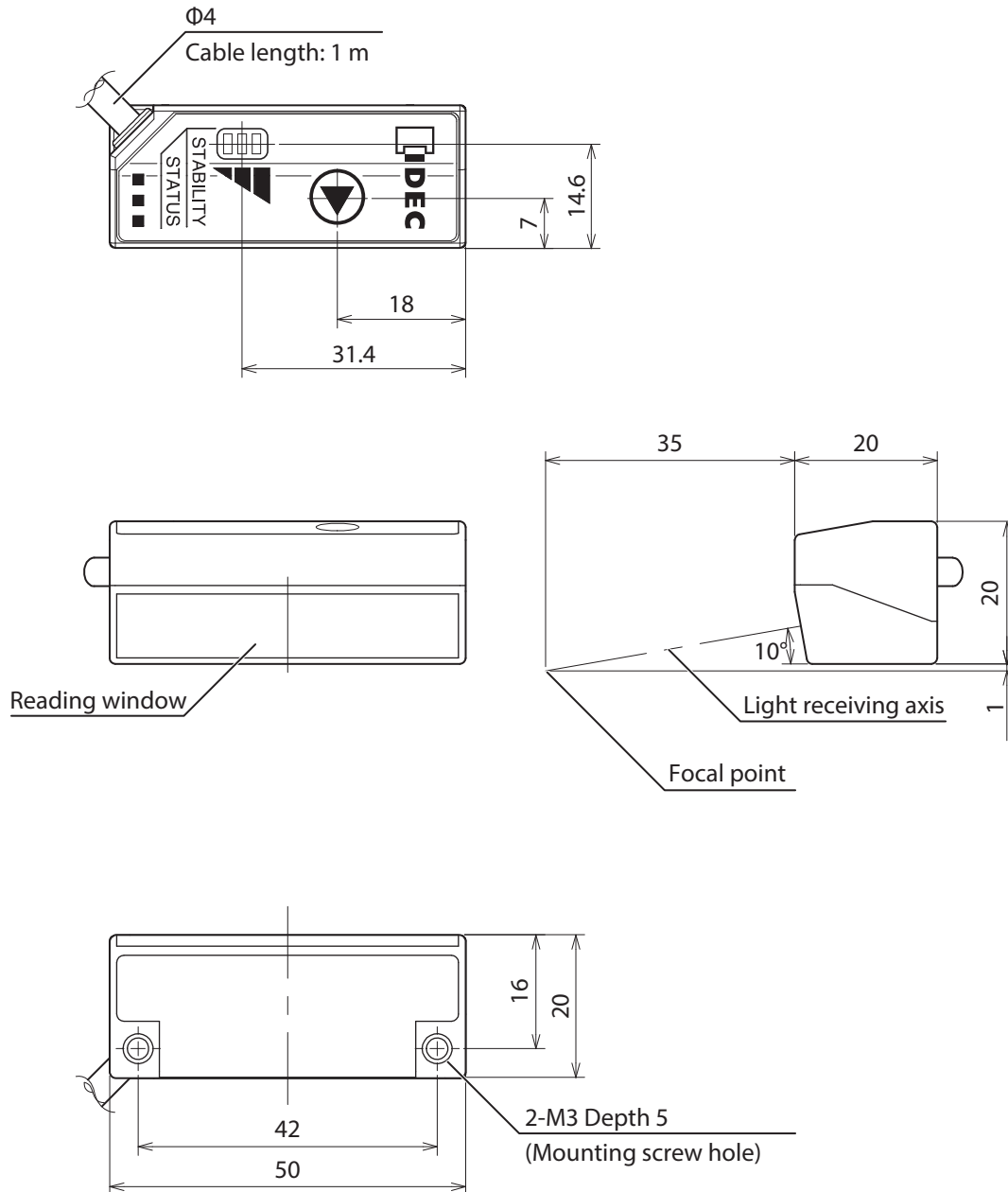

Unit: mm

5.4 Troubleshooting

RS-232 Type

USB Type

When using the WB1F, if an operation occurs that you think is a problem, read the following problems and items to check to resolve the problem.

If you cannot resolve the problem, contact your local dealer or customer service.

Problem	Type	Items to check
Emitter LED does not turn on	RS-232 Type	<ul style="list-style-type: none"> • Are the positive and negative wires for the 5 V power supply correctly connected?
	USB Type	<ul style="list-style-type: none"> • Has the USB connector been firmly inserted straight into the USB port on the host device in the correct orientation? • Is the host device's power on?
Cannot read barcodes	RS-232 Type USB Type	<ul style="list-style-type: none"> • Are the barcodes dirty? • Is the WB1F reading window dirty? • Has the film been left on the reading window? • Is there are a problem with the WB1F installation position? • Is there are a problem with the WB1F settings?
Communication is not possible	RS-232 Type	<ul style="list-style-type: none"> • Are the RS-232 communication settings correct? • Are the communication settings between the host device and the WB1F the same? • Is the wiring correct?
	USB Type	<ul style="list-style-type: none"> • Has the USB driver been installed? • When using terminal software on a computer, has the terminal software been started after the computer recognizes the WB1F?
The indicator LEDs are not on	RS-232 Type USB Type	<ul style="list-style-type: none"> • Are the indicator LED settings correct?
The OK output and NG output do not work	RS-232 Type	<ul style="list-style-type: none"> • Are the OK output and NG output settings correct? • Is the wiring correct?
The PWM output does not work	RS-232 Type	<ul style="list-style-type: none"> • Are the PWM output settings correct? • Is the wiring correct?
The reading request does not turn on with the Operation button	RS-232 Type USB Type	<ul style="list-style-type: none"> • Are the Operation button settings correct?
The reading request does not turn on with external trigger input	RS-232 Type	<ul style="list-style-type: none"> • Are the external trigger input settings correct? • Is the wiring correct?

5.5 Control commands list

RS-232 Type

USB Type

No.	Name	Control command			Description
		Prefix	Mnemonic	Suffix	
1	Start barcode reading	^	get	CR LF	Starts barcode reading.
2	Stop barcode reading	^	stop	CR LF	Stops barcode reading.
3	Start matching	^	cmp[reference data]	CR LF	Starts barcode reading and performs matching. The matching result is output. Reference data to sequentially input can be added. Example: ^cmp12345 CR LF
4	OK output off	^	ok0	CR LF	Stops the OK output.
5	OK output on	^	ok1	CR LF	Starts the OK output. (Polarity and duration follow the setting values.)
6	NG output off	^	ng0	CR LF	Stops the NG output.
7	NG output on	^	ng1	CR LF	Starts the NG output. (Polarity and duration follow the setting values.)
8	PWM output off (When successful settings)	^	pwma0	CR LF	Stops the PWM output.
9	PWM output on (When successful settings)	^	pwma1	CR LF	Starts the PWM output. (Frequency, duration, and duty follow the setting values.)
10	PWM output off (When failure settings)	^	pwmb0	CR LF	Stops the PWM output.
11	PWM output on (When failure settings)	^	pwmb1	CR LF	Starts the PWM output. (Frequency, duration, and duty follow the setting values.)
12	Indicator LED (red) off	^	leda0	CR LF	Sets the indicator LED (red) to the off state.
13	Indicator LED (red) on	^	leda1	CR LF	Sets the indicator LED (red) to the on state. (Display pattern and illumination time follow the setting values.)
14	Indicator LED (orange) off	^	ledb0	CR LF	Sets the indicator LED (orange) to the off state.
15	Indicator LED (orange) on	^	ledb1	CR LF	Sets the indicator LED (orange) to the on state. (Display pattern and illumination time follow the setting values.)
16	Indicator LED (green) off	^	ledc0	CR LF	Sets the indicator LED (green) to the off state.
17	Indicator LED (green) on	^	ledc1	CR LF	Sets the indicator LED (green) to the on state. (Display pattern and illumination time follow the setting values.)
18	Switch to setup support mode (Reading rate)	^	sup0	CR LF	Switches to setup support mode and starts the setup support function reading rate measurement.
19	Switch to setup support mode (Reading count)	^	sup1	CR LF	Switches to setup support mode and starts the measurement of the reading number of times with setup support function.
20	Switch to slave mode	^	slave	CR LF	Switches to slave mode.
21	Switch to maintenance mode	^	mainte	CR LF	Switches to maintenance mode.

No.	Name	Control command			Description
		Prefix	Mnemonic	Suffix	
22	Reset (after 10 seconds)	^	reset10	CR LF	Executes a reset after 10 seconds.
23	Reset (after 5 seconds)	^	reset5	CR LF	Executes a reset after 5 seconds.
24	Reset (after 1 second)	^	reset	CR LF	Executes a reset after 1 second.
25	Load setting values	^	load	CR LF	Loads the setting values from the currently selected setting value region (non-volatile memory).
26	Save setting values	^	save	CR LF	Saves the setting values to the currently selected setting value region (non-volatile memory).
27	Initialize setting values	^	iNiTiAl	CR LF	Resets all setting values to the factory defaults.
28	Select setting value region (0)	^	select0	CR LF	A setting value region is a region where setting values are saved. The WB1F has eight setting value regions. Input the command that corresponds to the setting value region to select the specified region.
29	Select setting value region (1)	^	select1	CR LF	
30	Select setting value region (2)	^	select2	CR LF	
31	Select setting value region (3)	^	select3	CR LF	
32	Select setting value region (4)	^	select4	CR LF	
33	Select setting value region (5)	^	select5	CR LF	
34	Select setting value region (6)	^	select6	CR LF	
35	Select setting value region (7)	^	select7	CR LF	
36	Get selection number (Current value)	^	selgetc	CR LF	Gets the currently selected setting value region number. Example: Response when setting value region (0) is selected ^0 CR LF For details, refer to P. 5-9 "Detailed response examples" .
37	Get selection number (Memory value)	^	selgetm	CR LF	Gets the currently selected setting value region number assigned to memory (the number applied at startup). Example: Response when setting value region (1) is assigned to memory ^1 CR LF For details, refer to P. 5-9 "Detailed response examples" .
38	Save selection number	^	selmem	CR LF	Assigns the currently selected number to memory (the number applied at startup).
39	Get version	^	ver	CR LF	Gets the version of the firmware. Example: Response when getting the version ^WB1F-100S1*/A-001.000.00/ B-001.000.00 CR LF * is B for the RS-232 type and S for the USB type. For details, refer to P. 5-9 "Detailed response examples" .

No.	Name	Control command			Description
		Prefix	Mnemonic	Suffix	
40	Get communication settings (Current value)	^	comgetc	CR LF	<p>Gets the RS-232 interface communication settings. (Current value)</p> <p>Example: Response when getting the current values of the communication settings</p> <p>^07,01,01,00,00/00,00,00,00/5e,00,00,00/0d,0a,00,00 CR LF</p> <p>(^baud rate, data length, parity, stop bits, flow control/reserved, add check digit, uppercase response, reserved/4 prefixes/4 suffixes CR LF)</p> <p>For details, refer to P. 5-9 "Detailed response examples".</p>
41	Get communication settings (Memory value)	^	comgetm	CR LF	<p>Gets the RS-232 interface communication settings. (The setting values applied at startup)</p> <p>Example: Response when getting the communication settings applied at startup</p> <p>^07,01,01,00,00/00,00,00,00/5e,00,00,00/0d,0a,00,00 CR LF</p> <p>(^baud rate, data length, parity, stop bits, flow control/reserved, add check digit, uppercase response, reserved/4 prefixes/4 suffixes CR LF)</p> <p>For details, refer to P. 5-9 "Detailed response examples".</p>



- The prefix and suffix listed in the control commands list are the factory default settings.
- When "save setting values" is executed, the non-volatile memory is overwritten. Keep in mind that the non-volatile memory can be overwritten 100,000 times.

Detailed response examples

•No. 36 Get selection number (current value)

Prefix	Selection number (Current value)	Suffix
^	0	CR LF

Selection number is a numeric value from "0" to "7".

•No. 37 Get selection number (memory value)

Prefix	Selection number (Memory value)	Suffix
^	0	CR LF

Selection number is a numeric value from "0" to "7".

•No. 39 Get version

Prefix	Model number	Separator	Main application version	Separator	Bootloader version	Suffix
^	WB1F-100S1S	/	A-001.000.00	/	B-001.000.00	CR LF

The model number is "WB1F-100B1S" for the RS-232 type and "WB1F-100S1S" for the USB type.

The main application version is the numeric values in the format 3-digit.3-digit.2-digit that follow A- which indicates the main application.

The bootloader version is the numeric values in the format 3-digit.3-digit.2-digit that follow B- which indicates the bootloader.

•No.40 Get communication settings (current values), No. 41 Get communication settings (memory values)

Prefix	RS-232 settings					Separator
	Communication speed	Data length	Parity	Stop bits	Flow control	
^	03,	01,	01,	00,	00	/
Communication command						Separator
Reserved	Check digit addition	Uppercase response	Reserved			
00,	00,	00,	00			/
Communication command						Separator
Prefix	Prefix	Prefix	Prefix			
5e,	00,	00,	00			/
Communication command						Suffix
Suffix	Suffix	Suffix	Suffix			
0d,	0a,	00,	00			CR LF

The RS-232 settings are the setting values in "3. 5 Configuration item table" - [P. 3-36 "RS-232 settings"](#).

The communication command is the setting values in "3. 5 Configuration item table" - [P. 3-48 "Communication command Function"](#).

5.6 Check digit calculation method

RS-232 Type

USB Type

A check digit can be added to the output data for readout data and configuration commands. The check digit is expressed as an 2 digit hexadecimal ASCII code in text.

Calculation range and position where added

The calculation range of the check digit and the position where it is added are as follows.

- For output data

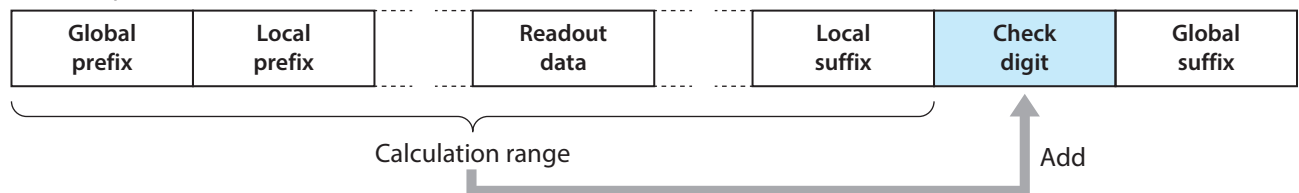

- For configuration commands



Calculation method

All of the ASCII code values for the calculation range are added up, that value is inverted, and 1 is added to it.

Example: `^s1234x118b` `CR` `LF`

$$5eH + 73H + 31H + 32H + 33H + 34H + 78H + 31H + 31H = 275H$$

$$275H \text{ NOT} = d8aH$$

$$d8aH + 1 = d8bH$$

$$d8bH \& 0ffH = 08bH$$

$$\text{Checksum} = 8bH$$

5.7 ASCII code table

RS-232 Type

USB Type

Character	Decimal	Hexadecimal	Binary
NUL	0	00	00000000
SOH	1	01	00000001
STX	2	02	00000010
ETX	3	03	00000011
EOT	4	04	00000100
ENQ	5	05	00000101
ACK	6	06	00000110
BEL	7	07	00000111
BS	8	08	00001000
HT	9	09	00001001
LF / NL	10	0A	00001010
VT	11	0B	00001011
FF / NP	12	0C	00001100
CR	13	0D	00001101
SO	14	0E	00001110
SI	15	0F	00001111
DLE	16	10	00010000
DC1	17	11	00010001
DC2	18	12	00010010
DC3	19	13	00010011
DC4	20	14	00010100
NAK	21	15	00010101
SYN	22	16	00010110
ETB	23	17	00010111
CAN	24	18	00011000
EM	25	19	00011001
SUB	26	1A	00011010

Character	Decimal	Hexadecimal	Binary
ESC	27	1B	00011011
FS	28	1C	00011100
GS	29	1D	00011101
RS	30	1E	00011110
US	31	1F	00011111
(SP)	32	20	00100000
!	33	21	00100001
"	34	22	00100010
#	35	23	00100011
\$	36	24	00100100
%	37	25	00100101
&	38	26	00100110
'	39	27	00100111
(40	28	00101000
)	41	29	00101001
*	42	2A	00101010
+	43	2B	00101011
,	44	2C	00101100
-	45	2D	00101101
.	46	2E	00101110
/	47	2F	00101111
0	48	30	00110000
1	49	31	00110001
2	50	32	00110010
3	51	33	00110011
4	52	34	00110100
5	53	35	00110101
6	54	36	00110110
7	55	37	00110111
8	56	38	00111000
9	57	39	00111001
:	58	3A	00111010
;	59	3B	00111011
<	60	3C	00111100

Character	Decimal	Hexadecimal	Binary
=	61	3D	00111101
>	62	3E	00111110
?	63	3F	00111111
@	64	40	01000000
A	65	41	01000001
B	66	42	01000010
C	67	43	01000011
D	68	44	01000100
E	69	45	01000101
F	70	46	01000110
G	71	47	01000111
H	72	48	01001000
I	73	49	01001001
J	74	4A	01001010
K	75	4B	01001011
L	76	4C	01001100
M	77	4D	01001101
N	78	4E	01001110
O	79	4F	01001111
P	80	50	01010000
Q	81	51	01010001
R	82	52	01010010
S	83	53	01010011
T	84	54	01010100
U	85	55	01010101
V	86	56	01010110
W	87	57	01010111
X	88	58	01011000
Y	89	59	01011001
Z	90	5A	01011010
[91	5B	01011011
\	92	5C	01011100
]	93	5D	01011101
^	94	5E	01011110
_	95	5F	01011111
`	96	60	01100000
a	97	61	01100001
b	98	62	01100010
c	99	63	01100011
d	100	64	01100100

Character	Decimal	Hexadecimal	Binary
e	101	65	01100101
f	102	66	01100110
g	103	67	01100111
h	104	68	01101000
i	105	69	01101001
j	106	6A	01101010
k	107	6B	01101011
l	108	6C	01101100
m	109	6D	01101101
n	110	6E	01101110
o	111	6F	01101111
p	112	70	01110000
q	113	71	01110001
r	114	72	01110010
s	115	73	01110011
t	116	74	01110100
u	117	75	01110101
v	118	76	01110110
w	119	77	01110111
x	120	78	01111000
y	121	79	01111001
z	122	7A	01111010
{	123	7B	01111011
	124	7C	01111100
}	125	7D	01111101
~	126	7E	01111110
DEL	127	7F	01111111

 indicates a control character.

(SP) indicates a space character.

The other characters indicate graphic characters.

5.8 AIM symbology ID table

RS-232 Type

USB Type

The AIM-compliant symbology identification IDs are as follows.

The output name is:

] + ID + modifier

A total of 3 digits.

However, for the AIM ID modifier, undefined items are output as "x".

Symbology name	AIM ID	
	ID	Modifier
Code39	A	0: No check character validation. No full ASCII processing. All data is transmitted as decoded. 1: Check character is validated and transmitted. 3: Check character is validated but not transmitted. 4: Full ASCII character conversion is executed. No check character validation. 5: Full ASCII character conversion is executed. Modulo 43 check character is validated and transmitted. 7: Full ASCII character conversion is executed. Modulo 43 check character is validated but not transmitted.
Codabar	F	0: Standard symbols, no special processing. 2: Check character validated. 4: Check character validated, but not transmitted.
Interleaved 2of5	I	0: No check character validation. 1: Check character is validated and transmitted. 3: Check character is validated but not transmitted.
Standard 2of5	S	0: No option
Matrix2of5	X	9
IATA	R	0: No check character validation 1: Check character is validated and transmitted. 3: Check character is validated but not transmitted.
Coop-2of5	X	9
Scode	X	9
Chinese-Post	X	9
UPC-A	E	0: Standard format (no add-on) 3: Add 2-digit or 5-digit add-on to EAN-13, UPC-A, or UPC-E0/E1 4: EAN-8 data
UPC-E0		
UPC-E1		
EAN-13		
EAN-8		
Code128/GS1-128	C	0: Standard format 1: GS-128
Code93	G	0
MSI/Plessey	M	0: Check character is validated and transmitted. 1: Check character is validated but not transmitted. X: Other than above (no check, 2-digit check, no 2 digits transmission, etc.)
Italian Pharmacy	X	9
CIP39	X	9

Symbology name	AIM ID	
	ID	Modifier
Tri-Optic	X	9
TELEPEN	B	0: Full ASCII mode 1: Number limited mode
Code11	H	0: Check character 1 digit is validated and transmitted. 1: Check character 2 digits is validated and transmitted 3: Check character is validated but not transmitted. X: Check character is not validated.
GS1 Databar	e	0

5.9 GS1-128 Application Identifier

RS-232 Type**USB Type**

WB1F supports Application Identifier (AI) of GS1. Please refer to the following table about a symbol and the version to support.

AI is established by GS1 which is an international organization managing the international standard.

Please check the official website of GS1 about more information of AI.

Support symbol	Support version
GS1-128	2014-2019 version

5.10 Configuration barcode

RS-232 Type

USB Type

The configuration barcode is for changing the WB1F setting values.

● Initialize

If the configuration barcode is read in maintenance mode, the WB1F settings will be initialized to the factory defaults.

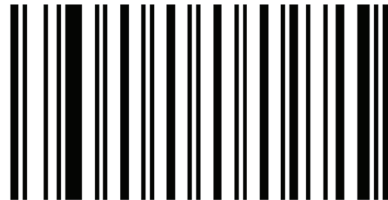

To switch to maintenance mode, refer to [P. 3-33 "3. 4. 1 Switching operation to maintenance mode"](#).

5.11 Sample labels

RS-232 Type

USB Type

This section contains sample labels. Print them out and use them as necessary.

Code39



Codabar



Interleaved 2of5



Standard 2of5



UPC-A



JAN/EAN-13 (GTIN-13)



UPC-E

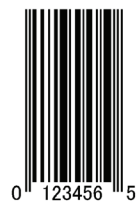

JAN/EAN-8 (GTIN-8)

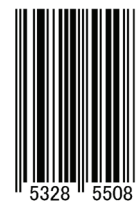

Code-128



Code93



Code11



MSI Plessey



GS1 Databar Expanded



GS1 Databar Limited



GS1 Databar Omni-directional



The unit may not be able to read some barcodes depending on its settings. When executing reading, change the settings to the appropriate setting values.

5.12 Installing the USB driver (USB type)

RS-232 Type

USB Type

To use the USB type connected to a computer, the USB driver must be installed.

The USB driver is made available on the IDEC website. Download and install the latest USB driver from the IDEC website.

For details on the USB driver, refer to the included documentation.

5.13 Setting check digit

RS-232 Type

USB Type

Each symbology has two settings, "Inspection of check digit Enabled/Disabled" and "Check digit sending Send/Not send". The settings that define the manner in which the WB1F operates are as follows.

The WB1F recognizes the last digit (excluding the start/stop characters) as the check digit when the check digit is defined in each symbology.

Inspection of check digit

- **Enabled : Check digit is inspected.**

The code can be read when the check result is correct, but cannot be read if the check result is incorrect.

- **Disabled : Check digit is not inspected.**

Since the check digit is not inspected, the code can be read whether or not the check digit is correct.

Check digit sending

- **Send : Check digit is sent.**

The check digit is sent when the check digit is added to the barcode. The last digit is sent when the check digit is not added.

- **Not send : Check digit is not sent.**

The check digit is not sent when the check digit is added to the barcode. The last digit is not sent when the check digit is not added.

As an example, here is an explanation of barcode reading results when two options, "Check digit check Enabled/Disabled" and "Check digit sending Send/Not send", are used in different combinations.

Example: Barcode without check digit

Item	Setting value
Symbology	Code39
Barcode data	1234567890
Check digit	Not added



Check digit		Reading results*	Remarks
Check	Sending		
Disabled	Not send	123456789	The last digit "0" is not output.
Disabled	Send	1234567890	It outputs the barcode data.
Enabled	Not send	Unreadable	The last digit "0" is recognized as the check digit and the code is checked. It may be read if it is checked correctly.
Enabled	Send	Unreadable	

* When "Start/stop character sending" of Decoder Code39 is set to "Disabled".

Example: Barcode with check digit correctly added

Item	Item
Symbology	Code39
Barcode data	1234567890
Check digit	Added ("2")



Check digit		Reading results*	Remarks
Check	Sending		
Disabled	Not send	1234567890	Check digit "2" is not sent.
Disabled	Send	12345678902	Default
Enabled	Not send	1234567890	The code can be read since the check digit is correctly added.
Enabled	Send	12345678902	

* When "Start/stop character sending" of Decoder Code39 is set to "Disabled".

Example: Barcode with check digit incorrectly added

Item	Setting value
Symbology	Code39
Barcode data	1234567890
Check digit	Added ("3")



12345678903

Check digit		Reading results*	Remarks
Check	Sending		
Disabled	Not send	1234567890	Check digit "3" is not sent.
Disabled	Send	12345678903	Default
Enabled	Not send	Unreadable	The code cannot be read since the check digit is incorrectly added.
Enabled	Send	Unreadable	

* When "Start/stop character sending" of Decoder Code39 is set to "Disabled".



- Check digit is effective to avoid incorrect reading.
- It is recommended to add the check digit to barcodes.

5.14 Setting margin rate

RS-232 Type

USB Type

When observed from the upper side of the WB1F, the right margin is the quiet zone on the right side, and the left margin is the quiet zone on the left side.

The right margin rate is the percentage of the right margin, which is set commonly for all the symbology. The left margin rate is the percentage of the left margin, which can be set differently for each symbology.

The diagram below shows the positions of the right margin and left margin.

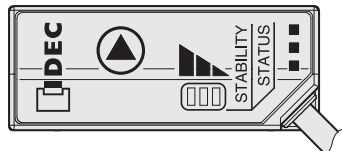

Normally, a barcode whose quiet zone is less than the defined value cannot be read but you can make it readable by changing the setting values of the right margin rate and the left margin rate. However, changing the setting values may lead to misreading and affect the reading results. Please assess the influence carefully before changing the setting values.

Please use this setting as an emergency plan when you have mistakenly printed barcodes without enough quiet zones.

In other cases, it is recommended that the setting values of the margin rates not be changed.

As an example, here is an explanation of a right margin rate.

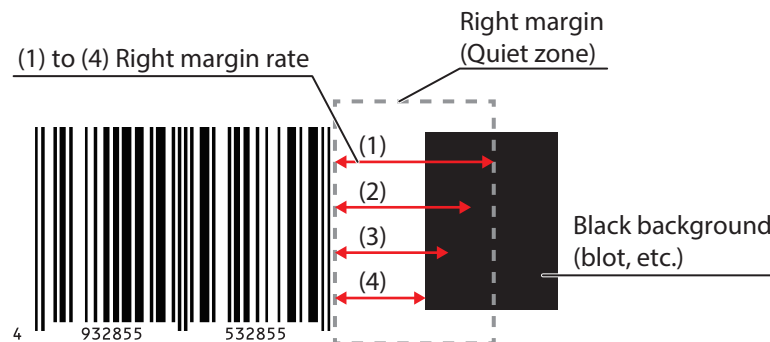

No.	Margin rate setting value	Readability
(1)	Normal	Unreadable
(2)	6/7	Unreadable
(3)	5/7	Unreadable
(4)	4/7	Readable

* Barcodes are readable when the setting value of the margin rate is 4/7 or less (3/7, 2/7, 1/7).

5.15 Index

A

Additional information table	3-14
AIM symbology ID table	5-13
Alias registration	3-24
Analysis.....	3-23
Angular characteristic.....	5-3
ASCII code table.....	5-11

B

Barcode reading	3-4
Barcode reading methods	3-4

C

Check digit.....	5-20
Check digit calculation method.....	5-10
Cleaning methods.....	vii
Cleaning the reading window.....	vii
Cleaning the unit	vii
Command alias	3-24
Communication command	3-26
Comparison-Matching	3-18
Configuration barcode.....	5-16
Configuration commands.....	3-28
Configuration item table.....	3-36
Connecting cable	1-2
Control commands.....	3-27
Control commands list.....	5-6

D

Detailed procedure using the Operation button	
Maintenance mode.....	3-34
Setup support mode.....	3-30
Dimensional outline drawings	5-4

F

Field of view	5-2
Firmware updating	3-35

I

Indicator LED	1-2
Initialize	5-16
Installation precautions	2-1

M

Maintenance mode.....	3-33
Maintenance support	3-35

Margin rate.....	5-23
Matching.....	3-22
Multiple label read collectively output	3-9
Output data format	3-12
Multiple label read sequential output	3-8
Output data format	3-11

O

Operation button.....	1-2
Operation mode.....	3-1
Operation mode switching operation and status....	3-2
Output data additional information	3-11
Data output format after matching.....	3-13
Multiple label read collectively output	3-12
Output data editing	3-16

P

Part names and functions.....	1-2
Pitch.....	5-3
Precautions for Use.....	vi
Product specifications.....	5-1

Q

Quiet zone.....	5-2
-----------------	-----

R

Reading count measurement.....	3-32
Reading operation	3-5
Reading rate measurement.....	3-31
Reading window	1-2
Readout data extraction and concatenation	3-16
Reference data pre-registration	3-18
Reference data sequential input	3-21
Replacement of control character	3-17

S

Safety precautions.....	v
Sample labels	5-17
Setup barcode position	2-4
Setup support function	3-31
Setup support mode.....	3-29
Single label read.....	3-5
Edge-triggered.....	3-6
Level-triggered.....	3-7
Output data format	3-11
Skew.....	5-3

Slave mode	3-3
Start conditions and stop conditions for reading requests.....	3-10
Support tool.....	4-1
Switching operation	
Maintenance mode.....	3-33
Setup support mode.....	3-29
Slave mode	3-3
System configuration.....	1-3

T

Tilt.....	5-3
Troubleshooting.....	5-5

U

USB connector pin assignment.....	2-8
USB driver	5-19

W

WB1F mounting methods.....	2-3
WB1F support tool.....	4-1
Wiring.....	2-5
Wiring the RS-232 type	2-5
External trigger input	2-7
NG output	2-4
OK output.....	2-7
PWM output.....	2-7
Wire colors.....	2-5
Wiring external trigger input.....	2-6
Wiring the power supply	2-6
Wiring the USB type.....	2-8

Revision history

Edition	Published	Revised content	
		Page	Points
1st	2015.04	-	-
2nd	2016.03	ii	Addition of Version up information
		iii	Addition of General terms, abbreviations, and terminology used in this manual
		viii	Addition of Related manuals
		2-7	Addition of RS-232 setting at the time of the factory shipment
		3-46	3.5 Configuration item table Command alias Start barcode reading command[1] (NG)0F →(OK)1F
		3-47	3.5 Configuration item table Command alias Stop barcode reading command[1] (NG)0F →(OK)1F
		3-49	3.5 Configuration item table Decoder Codabar(NW7) Inspection of check digit (NG)01 →(OK)00
		3-49	3.5 Configuration item table Decoder Codabar(NW7) Check digit sending (NG)00 →(OK)01
		3-50	3.5 Configuration item table Decoder Interleaved 2of5 (NG)EAN-13 conversion output →(OK)EAN-13 conversion
		3-53	3.5 Configuration item table Decoder UPC-E0 Chang from Country code characters addition to Reserved
3-54	3.5 Configuration item table Decoder UPC-E1 Chang from Country code characters addition to Reserved		
3-56	3.5 Configuration item table Decoder MSI/Plessey Check digit type selection (NG)03:MOD11+MOD11 →(OK)03:MOD11+MOD10		
3rd	2016.06	ii	Addition of Version up information
		3-36	3.5 Configuration item table RS-232 Setting Communication speed Addition of 0a : 600bps
4th	2016.12	—	(NG)Start margin rate →(OK)Right margin rate
		—	(NG)End margin rate →(OK)Left margin rate
		—	Addition of Version up information
		vi	Addition of Precautions for Use
		5-8	5.5 Control commands list Addition of Note
		5-20	Addition of "5.13 Setting check digit"
5-23	Addition of "5.14 Setting margin rate"		
5th	2017.05	—	Error correction
		ii	Addition of Version up information
		5-1	Addition of Product specifications
		5-15	GS1-128 Application Identifier Compliant with 2017 year edition AI

Edition	Published	Revised content	
		Page	Points
6th	2018.3	ii	Addition of Version up information
		5-15	GS1-128 Application Identifier Compliant with 2018 year edition AI
7th	2019.9	ii	Addition of Version up information
		3-14, 3-15	Changed to include addition of Decoding count addition function
		3-36	Added notes for configuring decoder-related items
		3-39	3.5 Configuration item table Added CCD settings (CCD drive settings, Number of CCD Idling times)
		3-40	3.5 Configuration item table Added Decoding count addition to output data additional information
		3-49	3.5 Configuration item table Added Algorithm settings
		5-4	Error correction
		5-15	GS1-128 Application Identifier Compliant with 2019 year edition AI

WB1F Fix Linear CCD Scanner

User's Manual

- B-1775(6)
- Published: September 2019 7th edition
- 6-64, Nishi-Miyahara 2-Chome, Yodogawa-ku, Osaka, Japan

IDEC CORPORATION © 2019 IDEC CORPORATION All Rights Reserved.

- The specifications and content in this manual may be changed without prior notification.
- Reproduction of this manual without prior permission is prohibited. All rights reserved.

IDEC CORPORATION

 www.idec.com

Head Office

6-64, Nishi-Miyahara-2-Chome, Yodogawa-ku, Osaka 532-0004, Japan

USA	IDEC Corporation	Tel: +1-408-747-0550	opencontact@idec.com	Hong Kong	IDEC Izumi (H.K.) Co., Ltd.	Tel: +852-2803-8989	info@hk.idec.com
Australia	IDEC Australia Pty. Ltd.	Tel: +61-3-8523-5900	sales@au.idec.com	China/Shanghai	IDEC (Shanghai) Corporation	Tel: +86-21-6135-1515	idec@cn.idec.com
Germany	IDEC Electrotechnik GmbH	Tel: +49-40-25 30 54 - 0	service@eu.idec.com	China/Shenzen	IDEC (Shenzen) Corporation	Tel: +86-755-8356-2977	idec@cn.idec.com
Singapore	IDEC Izumi Asia Pte. Ltd.	Tel: +65-6746-1155	info@sg.idec.com	China/Beijing	IDEC (Beijing) Corporation	Tel: +86-10-6581-6131	idec@cn.idec.com
Thailand	IDEC Asia (Thailand) Co., Ltd	Tel: +66-2-392-9765	sales@th.idec.com	Japan	IDEC Corporation	Tel: +81-6-6398-2527	marketing@idec.co.jp
Taiwan	IDEC Taiwan Corporation	Tel: +886-2-2698-3929	service@tw.idec.com				

Specifications and other descriptions in this brochure are subject to change without notice.
2017 IDEC Corporation, All Rights Reserved.

B-1775(6) September 2019





IDEC CORPORATION