

# MA Series Miniature Control Units

## Super bright LED for AC/DC Square-, rectangular-, and round-body, miniature control units

### Features



- Compact and space-saving (unibody: 22 mm)
- Super-bright LED unit
- Gold plated silver contacts for low-level signal switching integrity
- Also available with silver contacts
- High-performance contact mechanism
- Light-touch operation
- Built-in current limiting resistor and diode (LED)
- Quick installation into panel (front mounting)
- Optional barrier, switch guard, and socket
- UL/cUL-recognized, EN compliant



- See website for details on approvals and standards.



### MA Series

Item	MA2 (Square)	MA3 (Rectangular)	MA8 (Round)
Bezel Size	 □18 mm	 18H × 24W mm	 ø23.8 mm
Illumination Face Size	□13 mm	13H × 19W mm	ø19 mm
Light Source	LED		
Illumination Face Division (Note)	One-color Full, Two-way Split, Two-color Full Alternate		
Contact	Microswitch (Gold plated silver, Silver)		
No. of Contacts	SPDT or DPDT		
Operation Type	Momentary, maintained, pilot light		
Terminal Style	Solder/tab terminal #110		
Housing Color	Black		

Note: Two-way split illumination is available for MA3 (rectangular type) only.  
Two-color alternate illumination is available for MA2 and MA3 only.

### Contact Ratings

#### Gold Contact (Switch Base: Blue)

Rated Insulation Voltage	250V		
Rated Current	3A		
Rated Voltage	30V DC	125V AC	
Rated Operating Current (Resistive Load)	0.1A	0.1A	
Contact Material	Gold plated silver		

- Minimum applicable load (reference value): 5V AC/DC, 1mA

#### Silver Contact (switch base: gray)

Rated Insulation Voltage	250V				
Rated Operating Voltage	30V 125V 250V				
Rated Operating Current	AC 50/60Hz	Resistive load	—	3A	2A
		Inductive load	—	2A	1.5A
	DC	Resistive load	2A	0.4A	—
		Inductive load	1A	0.2A	—
Rated Thermal Current	5A				
Contact Material	Silver				

- AC inductive load: PF=0.6 to 0.7 DC inductive load: L/R=7 ms max.

### Illumination Ratings

Item	One-color Full			Two-color Full Alternate/Two-way Split
	Operating Voltage	5V DC ±5%	12V AC/DC ±5%	24V AC/DC ±5%
Rated Voltage	5V DC	12V AC/DC	24V AC/DC	24V AC/DC
Rated Current	7mA (*1)			
Life (Reference Value)	Approx. 30,000 hours (The luminance reduces to 50% of the initial intensity when used on complete DC.)			

Note: Built-in current limiting resistor and diode are supplied.  
\*1) R (red) for one-color full illumination is 9mA. (Per circuit)

### Specifications

Operating Temperature	-25 to +55°C (no freezing)	
Storage Temperature	-40 to +80°C (no freezing)	
Relative Humidity	35 to 85% RH (no condensation)	
Contact Resistance	50 mΩ maximum (initial value)	
Insulation Resistance	100 MΩ minimum (500V DC megger)	
Dielectric Strength	Switch	Between live and dead parts: 2000V AC, 1 minute Between terminals of different poles: 2000V AC, 1 minute Between contact terminals of the same pole: 1000V AC, 1 minute Between contact terminal and lamp terminal: 2000V AC, 1 minute
	Illumination Unit	Between live part and ground: 2000V AC, 1 minute
Vibration Resistance	Operating extremes: 10 to 55 Hz, amplitude 0.75 mm	
Shock Resistance	Damage limits: 500 m/s <sup>2</sup> Operating extremes: 200 m/s <sup>2</sup>	
Mechanical Life	Momentary: 1,000,000 operations minimum Maintained: 200,000 operations minimum	
Electrical Life	100,000 operations minimum (switching frequency 1200 operations/h)	
Degree of Protection	IP40 (IEC 60529)	

### One-color Full Illumination

Amber, green, red, blue, yellow, pure white

Note: The above figure shows MA3. MA2 also has the same configuration.

### Two-way Split Illumination

Green, red (MA3 only)

Note: The above figure shows the short two-way split type. The long two-way split type also has the same configuration.

### Two-color Full Alternate Illumination

Red ↔ Green

Note: The above figure shows MA3. MA2 also has the same configuration.

MA2 (Square)

MA3 (Rectangular)

MA8 (Round)

## Ordering Information

When ordering the MA series, specify the Part No.

- The color plate, marking plate and LED unit are contained within the MA series.
- Optional accessories (barrier, switch guard, socket, etc.) are available. When ordering, specify the Part No.
- Use a PW (pure white) LED unit for yellow illumination.

Part No. Development

# MA 3 L - M 1 3 4 1 R

Bezel/Illumination Face Size	
2	Square (18 × 18) 13 × 13
3	Rectangular (18 × 24) 13 × 19
8	Round (ø23.8) ø19

Operation	
M	Momentary
A	Maintained
blank	Pilot light

Housing (Black)	
1	MA2/MA8
3	MA3

Illumination Face Division	
1	Full
2	Long Two-way Split
3	Short Two-way Split
4	Two-color Alternate
9	Non-illuminated

Lens/Button Color	
A	Amber
B	Black
G	Green
PW	Pure White
R	Red
S	Blue
W	White
Y	Yellow

Function	
L	Illuminated pushbutton
B	Pushbutton
P	Pilot light

Contacts	
1	SPDT (gold)
2	DPDT (gold)
5	SPDT (silver)
6	DPDT (silver)
blank	No contact



Rated Operating Voltage	
1	5V DC
3	12V AC/DC
4	24V AC/DC
blank	Non-illuminated

- MA2 provides "Full Illumination" and "Two-color Alternate" illumination only.
- MA8 provides "Full Illumination" only.
- 24V AC/DC (RG, RPW, GPW, PWPW only) for two-way split illumination.
- 24V AC/DC (RG only) for two-color full alternate illumination.

- "B" and "W" apply to pushbuttons only.
- "A" and "PW" apply to illuminated pushbuttons and pilot lights only.

MA2 Illuminated Pushbuttons / Pilot Lights

Package Quantity: 1

Shape	Operation	Contact Material	Operating Voltage	Contact	Part No.	Illumination Color Code
<b>MA2 (Square) One-color Full</b> 	Momentary	Gold	24V AC/DC ±5%	SPDT	MA2L-M1141 *	Specify an illumination color code in place of * in the Part No.  A: amber G: green PW: pure white R: red S: blue Y: yellow
			12V AC/DC ±5%	DPDT	MA2L-M2141 *	
				SPDT	MA2L-M1131 *	
		5V DC ±5%	DPDT	MA2L-M2131 *		
			SPDT	MA2L-M1111 *		
		Silver	24V AC/DC ±5%	SPDT	MA2L-M5141 *	
			12V AC/DC ±5%	DPDT	MA2L-M6141 *	
				SPDT	MA2L-M5131 *	
		5V DC ±5%	DPDT	MA2L-M6131 *		
	SPDT		MA2L-M5111 *			
	Maintained	Gold	24V AC/DC ±5%	SPDT	MA2L-A1141 *	
			12V AC/DC ±5%	DPDT	MA2L-A2141 *	
				SPDT	MA2L-A1131 *	
		5V DC ±5%	DPDT	MA2L-A2131 *		
			SPDT	MA2L-A1111 *		
		Silver	24V AC/DC ±5%	SPDT	MA2L-A5141 *	
			12V AC/DC ±5%	DPDT	MA2L-A6141 *	
				SPDT	MA2L-A5131 *	
5V DC ±5%		DPDT	MA2L-A6131 *			
	SPDT	MA2L-A5111 *				
Pilot Light	—	24V AC/DC ±5%	—	MA2P-141 *		
		12V AC/DC ±5%	—	MA2P-131 *		
		5V DC ±5%	—	MA2P-111 *		
<b>MA2 (Square) Two-color Alternate</b> 	Momentary	Gold	24V AC/DC ±5%	SPDT	MA2L-M1144RG	Red (R) ↔ Green (G) alternate illumination
				DPDT	MA2L-M2144RG	
		Silver	24V AC/DC ±5%	SPDT	MA2L-M5144RG	
				DPDT	MA2L-M6144RG	
	Maintained	Gold	24V AC/DC ±5%	SPDT	MA2L-A1144RG	
				DPDT	MA2L-A2144RG	
		Silver	24V AC/DC ±5%	SPDT	MA2L-A5144RG	
				DPDT	MA2L-A6144RG	
	Pilot Light	—	24V AC/DC ±5%	—	MA2P-144RG	

•However, pilot lights are not CCC approved.

Dimensions

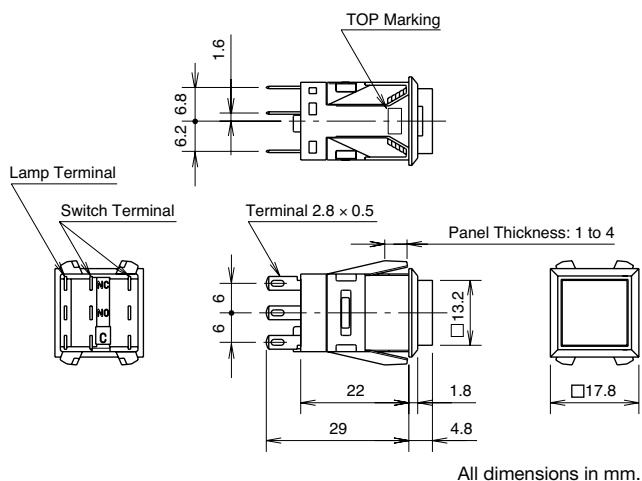

•See page 13 for panel cut-out.

Terminal Arrangement (Bottom View)

•For internal circuit, see page 16.  
 •5V DC polarity.  
 (Polarity not available for 12V, 24V AC/DC.)

Full Illumination

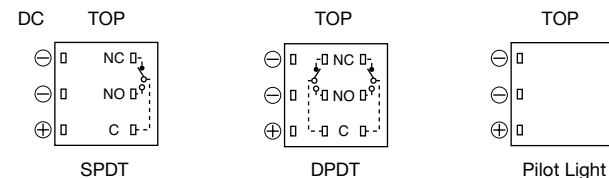

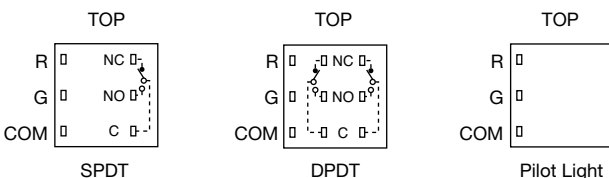

Two-color Alternate Illumination



MA3 Illuminated Pushbuttons / Pilot Lights

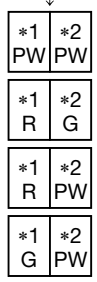

Package Quantity: 1

Shape	Operation	Contact Material	Operating Voltage	Contact	Part No.	Illumination Color Code		
<b>MA3 (Rectangular) One-color Full</b> 	Momentary	Gold	24V AC/DC ±5%	SPDT	MA3L-M1341 *	Specify an illumination color code in place of * in the Part No.  A: amber G: green PW: pure white R: red S: blue Y: yellow		
			12V AC/DC ±5%	DPDT	MA3L-M2341 *			
			5V DC ±5%	SPDT	MA3L-M1331 *			
				DPDT	MA3L-M2331 *			
			Silver	24V AC/DC ±5%	SPDT		MA3L-M5341 *	
				12V AC/DC ±5%	DPDT		MA3L-M6341 *	
		SPDT			MA3L-M5331 *			
		DPDT		MA3L-M6331 *				
		Maintained	Gold	24V AC/DC ±5%	SPDT		MA3L-A1341 *	
				12V AC/DC ±5%	DPDT		MA3L-A2341 *	
				5V DC ±5%	SPDT		MA3L-A1331 *	
			Silver	24V AC/DC ±5%	DPDT		MA3L-A2331 *	
	12V AC/DC ±5%			SPDT	MA3L-A1311 *			
				DPDT	MA3L-A2311 *			
	Pilot Light	—	24V AC/DC ±5%	—	MA3P-341 *			
			12V AC/DC ±5%	—	MA3P-331 *			
			5V DC ±5%	—	MA3P-311 *			
	<b>MA3 (Rectangular) Short Two-way Split</b>  [Standard Color] TOP Marking Side 	Momentary	Gold	24V AC/DC ±5%	SPDT		MA3L-M1343 [*1] [*2]	Specify illumination color codes for left and right sides in place of [*1] and [*2], respectively.  G: green PW: pure white R: red  Choose the color codes from the standard color arrangement shown below the photo on the left.
					DPDT		MA3L-M2343 [*1] [*2]	
			Silver	24V AC/DC ±5%	SPDT		MA3L-M5343 [*1] [*2]	
					DPDT		MA3L-M6343 [*1] [*2]	
Maintained		Gold	24V AC/DC ±5%	SPDT	MA3L-A1343 [*1] [*2]			
				DPDT	MA3L-A2343 [*1] [*2]			
		Silver	24V AC/DC ±5%	SPDT	MA3L-A5343 [*1] [*2]			
				DPDT	MA3L-A6343 [*1] [*2]			
Pilot Light		—	24V AC/DC ±5%	—	MA3P-343 [*1] [*2]			

- To mount the horizontal rectangular unit vertically, use the optional vertical leaf spring (MA9Z-T3: 2 pieces). (See page 12 and page 20.)
- For dimensions and terminal arrangement, see page 9. For internal circuit, see page 16.
- However, pilot lights are not CCC approved.

MA3 Illuminated Pushbuttons / Pilot Lights

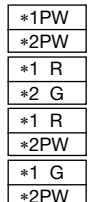
Package Quantity: 1

Shape	Operation	Contact Material	Operating Voltage	Contact	Part No.	Illumination Color Code
<b>MA3 (Rectangular) Long Two-way Split</b>  [Standard Color] TOP Marking Side 	Momentary	Gold	24V AC/DC ±5%	SPDT	MA3L-M1342 [*1] [*2]	Specify illumination color codes for left and right sides in place of [*1] and [*2], respectively.  G: green R: red  Choose the color codes from the standard color arrangement shown below the photo on the left.
		DPDT	MA3L-M2342 [*1] [*2]			
		Silver	24V AC/DC ±5%	SPDT	MA3L-M5342 [*1] [*2]	
		DPDT	MA3L-M6342 [*1] [*2]			
	Maintained	Gold	24V AC/DC ±5%	SPDT	MA3L-A1342 [*1] [*2]	
		DPDT	MA3L-A2342 [*1] [*2]			
		Silver	24V AC/DC ±5%	SPDT	MA3L-A5342 [*1] [*2]	
		DPDT	MA3L-A6342 [*1] [*2]			
	Pilot Light	—	24V AC/DC ±5%	—	MA3P-342 [*1] [*2]	
	<b>MA3 (Rectangular) Two-color Alternate</b> 	Momentary	Gold	24V AC/DC ±5%	SPDT	
DPDT			MA3L-M2344RG			
Silver			24V AC/DC ±5%	SPDT	MA3L-M5344RG	
DPDT			MA3L-M6344RG			
Maintained		Gold	24V AC/DC ±5%	SPDT	MA3L-A1344RG	
		DPDT	MA3L-A2344RG			
		Silver	24V AC/DC ±5%	SPDT	MA3L-A5344RG	
		DPDT	MA3L-A6344RG			
Pilot Light		—	24V AC/DC ±5%	—	MA3P-344RG	

•To mount the horizontal rectangular unit vertically, use the optional vertical leaf spring (MA9Z-T3: 2 pieces). (See page 12 and page 20.)

Dimensions

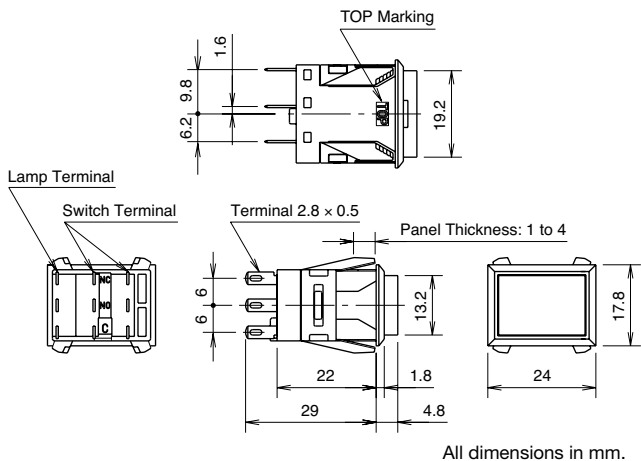

Terminal Arrangement (Bottom View)

For internal circuit, see page 16.  
Two-way Split Illumination

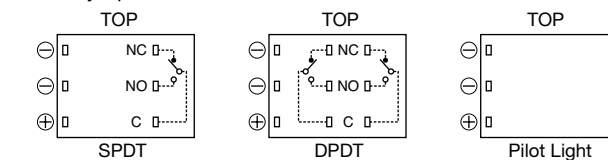

Two-color Alternate Illumination

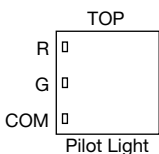

- Two negative (-) terminals are not interconnected inside.
- For "One-color Full" illumination, use the upper negative (-) terminal. For division into upper and lower sections, connect the negative (-) terminals for the upper and lower circuits separately.
- The above figure shows the polarities of the 5V DC type. (The 12V AC/DC and 24V AC/DC types have no polarity.)

MA8 Illuminated Pushbuttons / Pilot Lights

Package Quantity: 1

Shape	Operation	Contact Material	Operating Voltage	Contact	Part No.	Illumination Color Code
<b>MA8 (Round) One-color Full</b>  	Momentary	Gold	24V AC/DC ±5%	SPDT	MA8L-M1141 *	Specify an illumination color code in place of * in the Part No.  A: amber G: green PW: pure white R: red S: blue Y: yellow
				DPDT	MA8L-M2141 *	
			12V AC/DC ±5%	SPDT	MA8L-M1131 *	
				DPDT	MA8L-M2131 *	
			5V DC ±5%	SPDT	MA8L-M1111 *	
				DPDT	MA8L-M2111 *	
		Silver	24V AC/DC ±5%	SPDT	MA8L-M5141 *	
				DPDT	MA8L-M6141 *	
			12V AC/DC ±5%	SPDT	MA8L-M5131 *	
				DPDT	MA8L-M6131 *	
			5V DC ±5%	SPDT	MA8L-M5111 *	
				DPDT	MA8L-M6111 *	
	Maintained	Gold	24V AC/DC ±5%	SPDT	MA8L-A1141 *	
				DPDT	MA8L-A2141 *	
			12V AC/DC ±5%	SPDT	MA8L-A1131 *	
				DPDT	MA8L-A2131 *	
			5V DC ±5%	SPDT	MA8L-A1111 *	
				DPDT	MA8L-A2111 *	
		Silver	24V AC/DC ±5%	SPDT	MA8L-A5141 *	
				DPDT	MA8L-A6141 *	
			12V AC/DC ±5%	SPDT	MA8L-A5131 *	
DPDT				MA8L-A6131 *		
5V DC ±5%			SPDT	MA8L-A5111 *		
			DPDT	MA8L-A6111 *		
Pilot Light	—	—	—	MA8P-141 *		
			—	MA8P-131 *		
			—	MA8P-111 *		

• Use a pure white (PW) LED for yellow (Y) illumination.

Dimensions

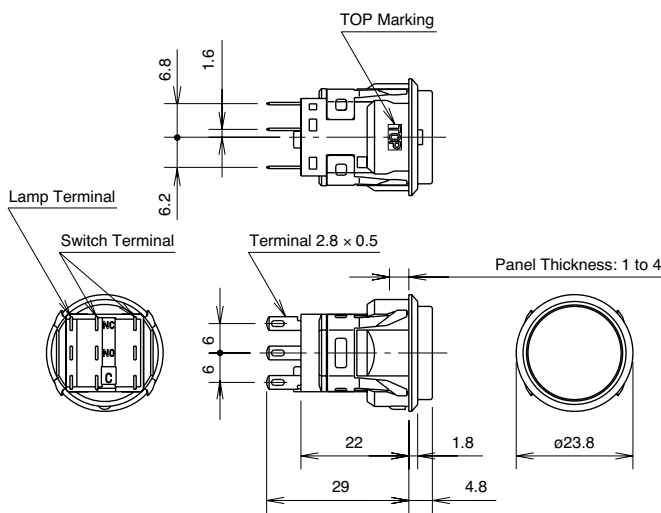

Terminal Arrangement (Bottom View)

- For internal circuit, see page 16.
- The following figure shows the polarities of the 5V DC type. (The 12V DC and 24V DC types have no polarity.)

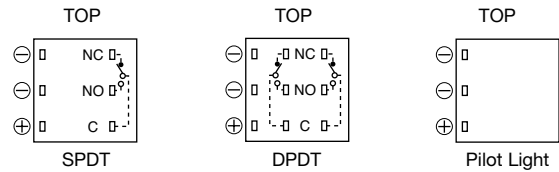

MA2 / MA3 / MA8 Pushbuttons

Package Quantity: 1

Shape	Operation	Contact Material	Contact	Part No.	Button Color Code	
					Button	Lens
<b>MA2 (Square)</b> 	Momentary	Gold	SPDT	MA2B-M119 *	Specify an opaque button color code in place of * in the Part No.	Specify a transparent lens color code in place of * in the Part No.
			DPDT	MA2B-M219 *		
		Silver	SPDT	MA2B-M519 *		
			DPDT	MA2B-M619 *		
	Maintained	Gold	SPDT	MA2B-A119 *		
			DPDT	MA2B-A219 *		
		Silver	SPDT	MA2B-A519 *		
			DPDT	MA2B-A619 *		
<b>MA3 (Rectangular)</b> 	Momentary	Gold	SPDT	MA3B-M139 *	Specify an opaque button color code in place of * in the Part No.	Specify a transparent lens color code in place of * in the Part No.
			DPDT	MA3B-M239 *		
		Silver	SPDT	MA3B-M539 *		
			DPDT	MA3B-M639 *		
	Maintained	Gold	SPDT	MA3B-A139 *		
			DPDT	MA3B-A239 *		
		Silver	SPDT	MA3B-A539 *		
			DPDT	MA3B-A639 *		
<b>MA8 (Round) Pushbuttons</b> 	Momentary	Gold	SPDT	MA8B-M119 *	Specify an opaque button color code in place of * in the Part No.	Specify a transparent lens color code in place of * in the Part No.
			DPDT	MA8B-M219 *		
		Silver	SPDT	MA8B-M519 *		
			DPDT	MA8B-M619 *		
	Maintained	Gold	SPDT	MA8B-A119 *		
			DPDT	MA8B-A219 *		
		Silver	SPDT	MA8B-A519 *		
			DPDT	MA8B-A619 *		

B: black  
G: green  
R: red  
S: blue  
W: white  
Y: yellow

LA: amber  
LG: green  
LR: red  
LS: blue  
LW: white  
LY: yellow

Note: The button is opaque. Color screen and a marking plate are not included. Apply marking directly on the button front surface, if required. Color screen and marking plates are included with lens style buttons.

• To mount the horizontal unit vertically, use the optional vertical leaf spring (MA9Z-T3: 2 pieces). (See page 12 and page 20.)

Dimensions

MA2 (Square)

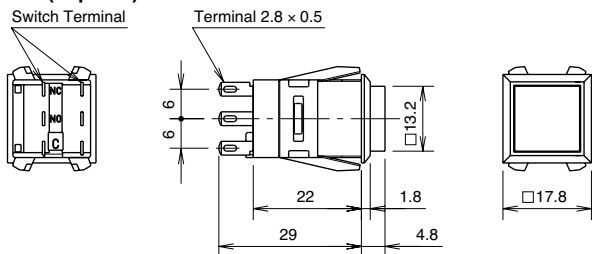

Terminal Arrangement (Bottom View)

For internal circuit, see page 16.

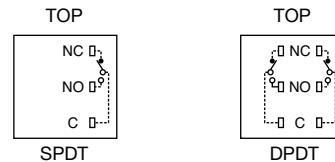

MA3 (Rectangular)

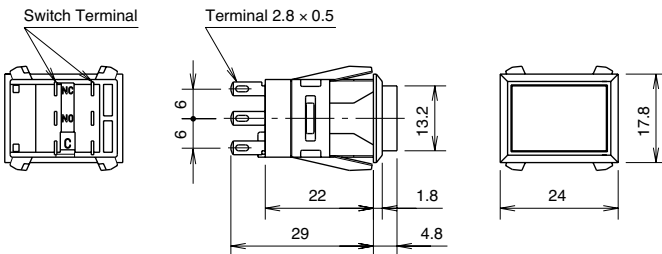

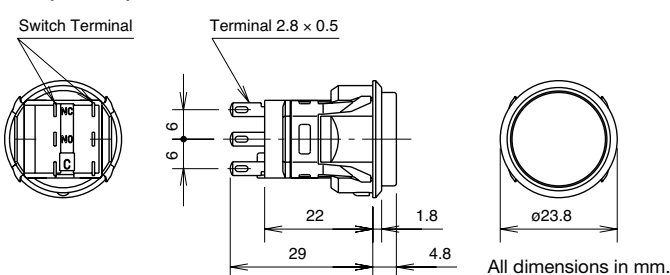

MA8 (Round)



All dimensions in mm.

Accessories

Name & Shape	Specifications	Part No.	Ordering No.	Package Quantity	Remarks	Dimension Page																					
Lens Removal Tool (Stainless steel) 	—	MT-101	MT-101	1	<ul style="list-style-type: none"> <li>Used to remove the lens from the housing. (Compatible with IDEC's A series Miniature Control Units)</li> </ul>	—																					
Socket (Polyamide) 	<table border="1"> <tr> <td>For MA2 Square</td> <td>Solder Terminals</td> <td>MA9Z-C2</td> <td>MA9Z-C2</td> <td>1</td> <td rowspan="4"> <ul style="list-style-type: none"> <li>Snaps onto the rear of MA units.</li> </ul> </td> <td rowspan="4">13</td> </tr> <tr> <td>For MA8 Round</td> <td>PC Board Terminals</td> <td>MA9Z-C2V</td> <td>MA9Z-C2V</td> <td>1</td> </tr> <tr> <td rowspan="2">For MA3 Rectangular</td> <td>Solder Terminals</td> <td>MA9Z-C3</td> <td>MA9Z-C3</td> <td>1</td> </tr> <tr> <td>PC Board Terminals</td> <td>MA9Z-C3V</td> <td>MA9Z-C3V</td> <td>1</td> </tr> </table>	For MA2 Square	Solder Terminals	MA9Z-C2	MA9Z-C2	1	<ul style="list-style-type: none"> <li>Snaps onto the rear of MA units.</li> </ul>	13	For MA8 Round	PC Board Terminals	MA9Z-C2V	MA9Z-C2V	1	For MA3 Rectangular	Solder Terminals	MA9Z-C3	MA9Z-C3	1	PC Board Terminals	MA9Z-C3V	MA9Z-C3V	1					
For MA2 Square	Solder Terminals	MA9Z-C2	MA9Z-C2	1	<ul style="list-style-type: none"> <li>Snaps onto the rear of MA units.</li> </ul>	13																					
For MA8 Round	PC Board Terminals	MA9Z-C2V	MA9Z-C2V	1																							
For MA3 Rectangular	Solder Terminals	MA9Z-C3	MA9Z-C3	1																							
	PC Board Terminals	MA9Z-C3V	MA9Z-C3V	1																							
Barrier (Polycarbonate) 	<table border="1"> <tr> <td rowspan="2">For MA2 Square For MA3 Rectangular</td> <td>End Barrier (Black)</td> <td>MA9Z-BF1B</td> <td>MA9Z-BF1BPN10</td> <td>10</td> <td rowspan="2"> <ul style="list-style-type: none"> <li>Used to prevent inadvertent operation and improve panel appearance.</li> <li>Note: For panel cut-out dimensions, see page 17.</li> </ul> </td> <td rowspan="2">14</td> </tr> <tr> <td>Spacer Barrier (Black)</td> <td>MA9Z-BF2B</td> <td>MA9Z-BF2BPN10</td> <td>10</td> </tr> </table>	For MA2 Square For MA3 Rectangular	End Barrier (Black)	MA9Z-BF1B	MA9Z-BF1BPN10	10	<ul style="list-style-type: none"> <li>Used to prevent inadvertent operation and improve panel appearance.</li> <li>Note: For panel cut-out dimensions, see page 17.</li> </ul>	14	Spacer Barrier (Black)	MA9Z-BF2B	MA9Z-BF2BPN10	10															
For MA2 Square For MA3 Rectangular	End Barrier (Black)		MA9Z-BF1B	MA9Z-BF1BPN10	10	<ul style="list-style-type: none"> <li>Used to prevent inadvertent operation and improve panel appearance.</li> <li>Note: For panel cut-out dimensions, see page 17.</li> </ul>			14																		
	Spacer Barrier (Black)	MA9Z-BF2B	MA9Z-BF2BPN10	10																							
Guard Barrier (Polycarbonate) 	<table border="1"> <tr> <td>For MA2 Square</td> <td>Black</td> <td>MA9Z-G2B</td> <td>MA9Z-G2BPN10</td> <td>10</td> <td rowspan="2"> <ul style="list-style-type: none"> <li>For panel cut-out dimensions, see page 17.</li> <li>Cannot be used in combination with barriers.</li> </ul> </td> <td rowspan="2">14</td> </tr> <tr> <td>For MA3 Rectangular</td> <td>Black</td> <td>MA9Z-GF3B</td> <td>MA9Z-GF3BPN10</td> <td>10</td> </tr> </table>	For MA2 Square	Black	MA9Z-G2B	MA9Z-G2BPN10	10	<ul style="list-style-type: none"> <li>For panel cut-out dimensions, see page 17.</li> <li>Cannot be used in combination with barriers.</li> </ul>	14	For MA3 Rectangular	Black	MA9Z-GF3B	MA9Z-GF3BPN10	10														
For MA2 Square	Black	MA9Z-G2B	MA9Z-G2BPN10	10	<ul style="list-style-type: none"> <li>For panel cut-out dimensions, see page 17.</li> <li>Cannot be used in combination with barriers.</li> </ul>	14																					
For MA3 Rectangular	Black	MA9Z-GF3B	MA9Z-GF3BPN10	10																							
Switch Guard (Polycarbonate) 	<table border="1"> <tr> <td>For MA2 Square</td> <td></td> <td>MA9Z-K2</td> <td>MA9Z-K2</td> <td>1</td> <td rowspan="2"> <ul style="list-style-type: none"> <li>180° opening spring return type</li> <li>Note: For panel cut-out dimensions, see page 18.</li> </ul> </td> <td rowspan="2">13</td> </tr> <tr> <td>For MA3 Rectangular</td> <td></td> <td>MA9Z-KF3</td> <td>MA9Z-KF3</td> <td>1</td> </tr> </table>	For MA2 Square		MA9Z-K2	MA9Z-K2	1	<ul style="list-style-type: none"> <li>180° opening spring return type</li> <li>Note: For panel cut-out dimensions, see page 18.</li> </ul>	13	For MA3 Rectangular		MA9Z-KF3	MA9Z-KF3	1														
For MA2 Square		MA9Z-K2	MA9Z-K2	1	<ul style="list-style-type: none"> <li>180° opening spring return type</li> <li>Note: For panel cut-out dimensions, see page 18.</li> </ul>	13																					
For MA3 Rectangular		MA9Z-KF3	MA9Z-KF3	1																							
Switch Guard with Lens (Polycarbonate) 	For MA3 Rectangular	MA9Z-KR3	MA9Z-KR3	1	<ul style="list-style-type: none"> <li>Not compatible with Maintained.</li> <li>For mounting procedure, see Mounting/Removing the Lens and Marking Plate on page 19.</li> <li>Cannot be used in combination with barriers.</li> </ul>	13																					
Dust Cover (Base: Polypropylene, Cover: Vinyl chloride elastomer) 	<table border="1"> <tr> <td>For MA2 Square</td> <td></td> <td>MA9Z-D2</td> <td>MA9Z-D2</td> <td>1</td> <td rowspan="2"> <ul style="list-style-type: none"> <li>Non-waterproof type</li> <li>For panel cut-out dimensions, see page 18.</li> </ul> </td> <td rowspan="2">14</td> </tr> <tr> <td>For MA3 Rectangular</td> <td></td> <td>MA9Z-D3</td> <td>MA9Z-D3</td> <td>1</td> </tr> </table>	For MA2 Square		MA9Z-D2	MA9Z-D2	1	<ul style="list-style-type: none"> <li>Non-waterproof type</li> <li>For panel cut-out dimensions, see page 18.</li> </ul>	14	For MA3 Rectangular		MA9Z-D3	MA9Z-D3	1														
For MA2 Square		MA9Z-D2	MA9Z-D2	1	<ul style="list-style-type: none"> <li>Non-waterproof type</li> <li>For panel cut-out dimensions, see page 18.</li> </ul>	14																					
For MA3 Rectangular		MA9Z-D3	MA9Z-D3	1																							
Dummy Unit (Polycarbonate) 	<table border="1"> <tr> <td>For MA2 Square</td> <td></td> <td>MA9Z-E2B</td> <td>MA9Z-E2B</td> <td>1</td> <td rowspan="2"> <ul style="list-style-type: none"> <li>Housing color: Black</li> </ul> </td> <td rowspan="2">14</td> </tr> <tr> <td>For MA3 Rectangular</td> <td></td> <td>MA9Z-E3FB</td> <td>MA9Z-E3FB</td> <td>1</td> </tr> </table>	For MA2 Square		MA9Z-E2B	MA9Z-E2B	1	<ul style="list-style-type: none"> <li>Housing color: Black</li> </ul>	14	For MA3 Rectangular		MA9Z-E3FB	MA9Z-E3FB	1														
For MA2 Square		MA9Z-E2B	MA9Z-E2B	1	<ul style="list-style-type: none"> <li>Housing color: Black</li> </ul>	14																					
For MA3 Rectangular		MA9Z-E3FB	MA9Z-E3FB	1																							
MA3 Vertical Leaf Spring (Stainless steel) 	Panel cut-out of vertical mounting 	MA9Z-T3	MA9Z-T3PN10	10	<ul style="list-style-type: none"> <li>By using the optional vertical leaf springs, MA3 can be vertically mounted in a horizontal row.</li> <li>For the mounting and removing procedures, see page 20.</li> </ul>	—																					



Accessory Dimensions

All dimensions in mm.

Socket

For MA2 Square  
For MA8 Round

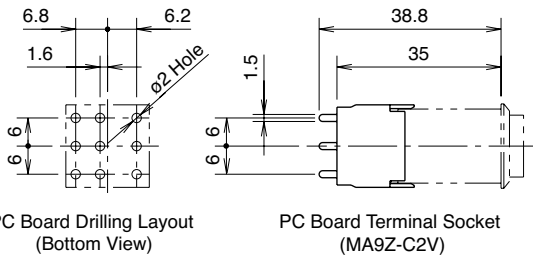
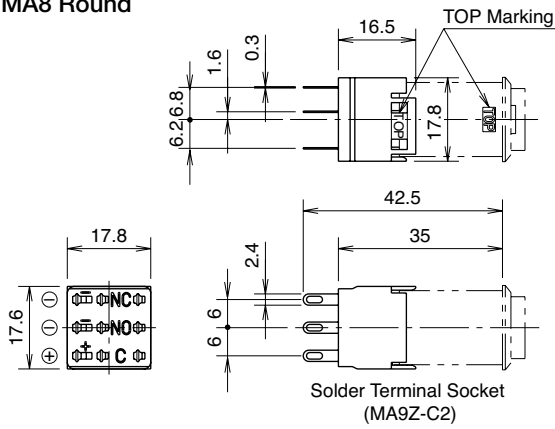

PC Board Drilling Layout (Bottom View)

For MA3 Rectangular

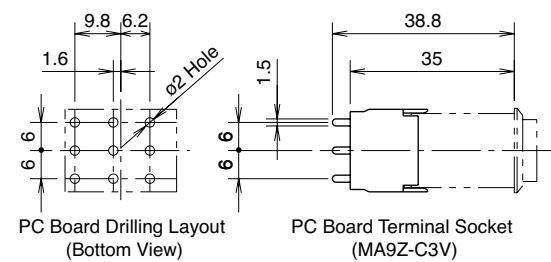
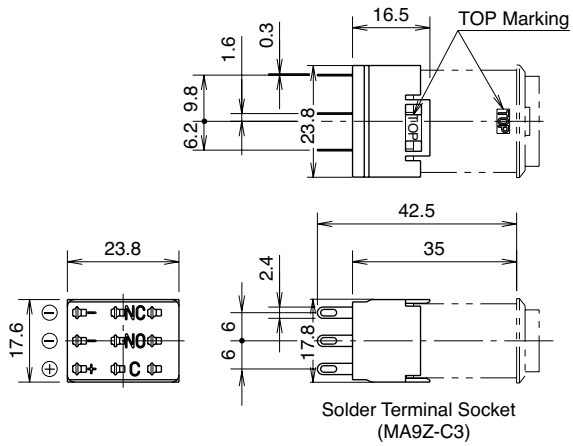

PC Board Drilling Layout (Bottom View)

Switch Guard

For MA2 Square (MA9Z-K2)

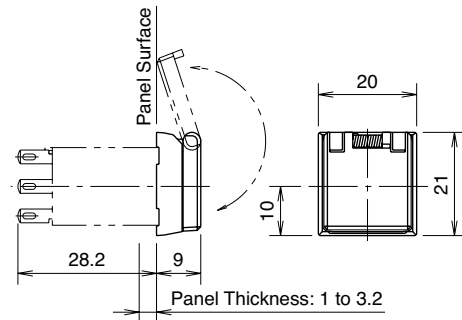

For MA3 Rectangular (MA9Z-KF3)

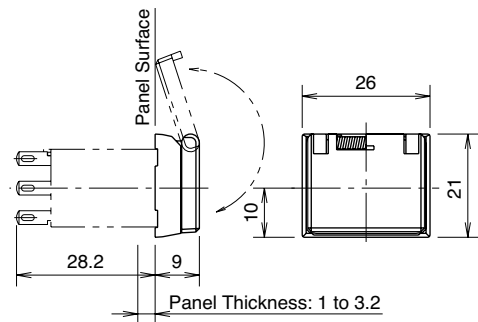

Note: For panel cut-out dimensions, see page 18.

Switch Guard with Lens

For MA3 Rectangular (MA9Z-KR3)

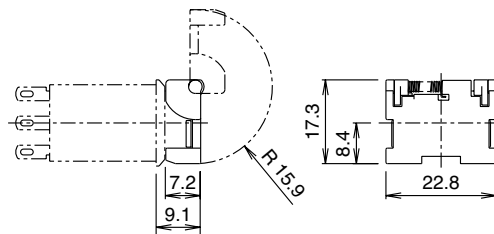

Note: The panel cut-out dimensions for the switch guard with lens are the same as those for the MA3 rectangular type.

Accessory Dimensions

All dimensions in mm.

Guard Barrier

For MA2 Square (MA9Z-G2B)

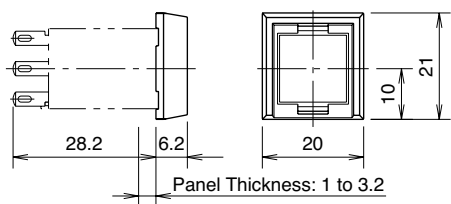

For MA3 Rectangular (MA9Z-GF3B)

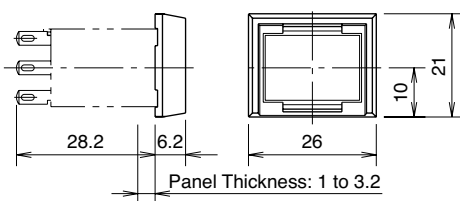

Note: For panel cut-out dimensions, see page 17.

Dummy Unit

For MA2 Square (MA9Z-E2B)

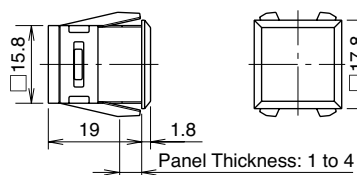

Note: For panel cut-out dimensions, see page 17 (same as guard barrier MA2 Square).

For MA3 Rectangular (MA9Z-E3FB)

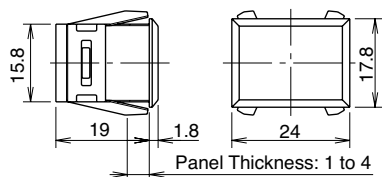

Note: For panel cut-out dimensions, see page 17 (same as guard barrier MA3 Rectangular).

Barrier

For MA2 Square

For MA3 Rectangular

End Barrier (MA9Z-BF1B)

Spacer Barrier (MA9Z-BF2B)

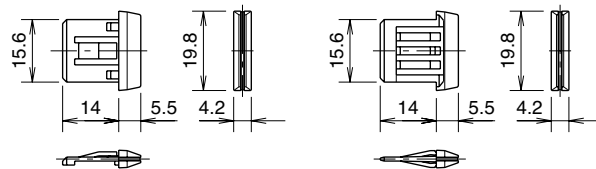

Note: For installation of the unit, see the panel cut-out dimensions on page 17.

Dust Cover

For MA2 Square (MA9Z-D2)

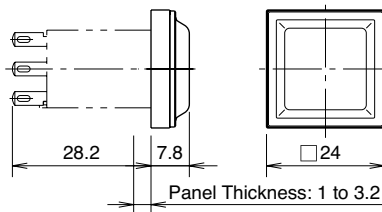



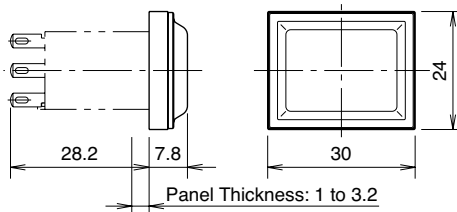

For MA3 Rectangular (MA9Z-D3)



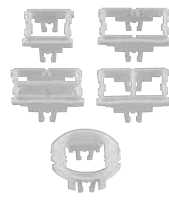

Note: For panel cut-out dimensions, see page 18.

Maintenance Parts

Name & Shape	Specifications		Part No.	Ordering No.	Package Quantity	Remarks
Color Screen (Acrylic) 	For MA2 Square	Full (11.5H × 11.5W × 1.1t)	MA9Z-P21 *	MA9Z-P21 * PN05	5	<ul style="list-style-type: none"> <li>Specify a color code in place of * in the Ordering No.</li> <li>A (Amber), C (Clear), R (Red), S (Blue)</li> </ul>
	For MA3 Rectangular	Full (11.5H × 17.5W × 1.1t)	MA9Z-P31 *	MA9Z-P31 * PN05	5	
		Long Two-way Split (5.7H × 17.5W × 1.1t)	MA9Z-P32 *	MA9Z-P32 * PN05	5	<ul style="list-style-type: none"> <li>Only C (Clear), G (Green), and R (Red) are available.</li> </ul>
		Short Two-way Split (11.5H × 8.7W × 1.1t)	MA9Z-P33 *	MA9Z-P33 * PN05	5	
	For MA8 Round	Full (ø17.2 × 1.1t)	MA9Z-P81 *	MA9Z-P81 * PN05	5	<ul style="list-style-type: none"> <li>A (Amber), C (Clear), G (Green), R (Red), S (Blue), Y (Yellow)</li> </ul>
Marking Plate (Acrylic) 	For MA2 Square	11.5H × 11.5W × 1.1t	MA9Z-P21W	MA9Z-P21WPN05	5	<ul style="list-style-type: none"> <li>No difference between both sides of the marking plate.</li> </ul>
	For MA3 Rectangular	11.5H × 17.5W × 1.1t	MA9Z-P31W	MA9Z-P31WPN05	5	
	For MA8 Round	ø17.2 × 1.1t	MA9Z-P81W	MA9Z-P81WPN05	5	
Lens (Polycarbonate) 	For MA2 Square		MA9Z-L2	MA9Z-L2PN05	5	<ul style="list-style-type: none"> <li>The lens is transparent.</li> </ul>
	For MA3 Rectangular		MA9Z-L3	MA9Z-L3PN05	5	
	For MA8 Round		MA9Z-L8	MA9Z-L8PN05	5	
Button (Polyarylate) 	For MA2 Square		MA9Z-B2 *	MA9Z-B2 * PN05	5	<ul style="list-style-type: none"> <li>Specify a color code in place of * in the Ordering No.</li> <li>B (Black), G (Green), R (Red), S (Blue), W (White), Y (Yellow)</li> </ul>
	For MA3 Rectangular		MA9Z-B3 *	MA9Z-B3 * PN05	5	
	For MA8 Round		MA9Z-B8 *	MA9Z-B8 * PN05	5	
Lens Holder (Polyarylate) 	For MA2 Square	Full	MA9Z-LH21	MA9Z-LH21PN05	5	
	For MA3 Rectangular	Full	MA9Z-LH31	MA9Z-LH31PN05	5	
		Long Two-way Split (with light barrier)	MA9Z-LH32	MA9Z-LH32PN05	5	
		Short Two-way Split (with light barrier)	MA9Z-LH33	MA9Z-LH33PN05	5	
	For MA8 Round	Full	MA9Z-LH81	MA9Z-LH81PN05	5	

Maintenance Parts (LED Unit)

Package Quantity: 1

Name & Shape	Specifications	Operational Voltage	Part No.	Remarks
MA2 Square / MA8 Round 	One-color	24V AC/DC ±5%	MA9Z-2D41N- *	<ul style="list-style-type: none"> <li>Specify a color code in place of * in the Ordering No.</li> <li>A (Amber), G (Green), PW (Pure White), R (Red), S (Blue)</li> </ul>
		12V AC/DC ±5%	MA9Z-2D31N- *	
		5V DC ±5%	MA9Z-2D11N- *	Use a PW (pure white) LED unit for yellow illumination.
	Two-color Alternate (Except for MA8)	24V AC/DC ±5%	MA9Z-2D44N-RG	<ul style="list-style-type: none"> <li>Color code: R (red), G (green)</li> </ul>
MA3 Rectangular 	One-color	24V AC/DC ±5%	MA9Z-3D41N- *	<ul style="list-style-type: none"> <li>Specify a color code in place of * in the Ordering No.</li> <li>A (Amber), G (Green), PW (Pure White), R (Red), S (Blue)</li> </ul>
		12V AC/DC ±5%	MA9Z-3D31N- *	
		5V DC ±5%	MA9Z-3D11N- *	Use a PW (pure white) LED unit for yellow illumination.
	Short Two-way Split	24V AC/DC ±5%	MA9Z-3D43N- **	<ul style="list-style-type: none"> <li>Specify a color code in place of * in the Ordering No.</li> <li>G (Green), R (Red), PW (pure white)</li> </ul>
	Long Two-way Split	24V AC/DC ±5%	MA9Z-3D42N- **	<ul style="list-style-type: none"> <li>For color codes of Two-way Split type, RG, RPW, GPW, PWPW are available.</li> </ul>
	Two-color Alternate	24V AC/DC ±5%	MA9Z-3D44N-RG	<ul style="list-style-type: none"> <li>Color code: R (red), G (green)</li> </ul>

Internal Circuit

MA2 (Square) / MA8 (Round)

MA2 (Square) MA8 (Round)	One-color	<p>5V DC</p>	<p>12V AC/DC · 24V AC/DC</p>
	Two-color Alternate (MA2)	<p>24V AC/DC</p>	

Note: Ⓐ, Ⓑ: LED modules (For details of the LED modules, see the LED module internal circuit below.)

MA3 (Rectangular)

MA3 (Rectangular)	One-color	<p>5V DC</p>	<p>12V AC/DC · 24V AC/DC</p>
	Short Two-way Split	<p>24V AC/DC</p>	
	Long Two-way Split	<p>24V AC/DC</p>	
	Two-color Alternate	<p>24V AC/DC</p>	

Note: Ⓐ, Ⓑ: LED modules (For details of the LED modules, see the LED module internal circuit below.)

LED Module Internal Circuit

Ⓐ	Ⓑ
<ul style="list-style-type: none"> <li>• LED</li> <li>• Rectifier circuit</li> <li>• Noise protection circuit</li> <li>• Dimmer protection circuit</li> </ul>	<ul style="list-style-type: none"> <li>• LED</li> <li>• Noise protection circuit</li> <li>• Dimmer protection circuit</li> </ul>

Panel Cut-out

Item	Front View (mm)	Panel Cut-out Dimensions (mm)	Remarks
MA2 Square			<p>N: No. of MA units mounted</p> <p>MA2 collective mounting Vertical: 4 rows max. Horizontal: 12 columns max.</p> <p>MA3 collective mounting Vertical: 4 rows max. Horizontal: 9 columns max.</p>
MA3 Rectangular			<p>* Consider the strength of panel thickness. Panel thickness: 1 to 4 mm</p>
MA8 Round			
With Barrier	MA2 Square		<p>N: No. of MA units mounted</p> <p>MA2 collective mounting Vertical: 4 rows max. Horizontal: 12 columns max.</p> <p>MA3 collective mounting Vertical: 4 rows max. Horizontal: 9 columns max.</p>
	MA3 Rectangular		<p>* Consider the strength of panel thickness. Panel thickness: 1 to 4 mm</p> <p>Note: When the barrier is mounted, the guard barrier, switch guard or dust cover cannot be mounted together.</p>
With Guard Barrier	MA2 Square		<p>N: No. of MA units mounted</p> <p>MA2 collective mounting Vertical: 4 rows max. Horizontal: 12 columns max.</p> <p>MA3 collective mounting Vertical: 4 rows max. Horizontal: 9 columns max.</p>
	MA3 Rectangular		<p>* Consider the strength of panel thickness. Panel thickness: 1 to 3.2 mm</p> <p>• The panel cut-out are the same as those required for switch guard. Therefore, the guard barrier and switch guard can be used together for collective mounting.</p>

Panel Cut-out

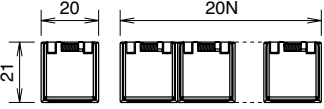
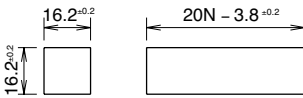
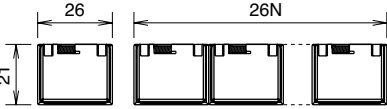
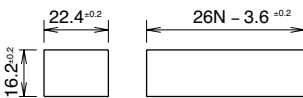
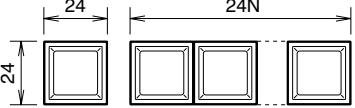
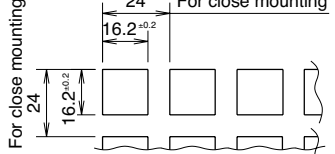
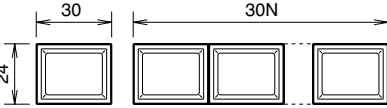
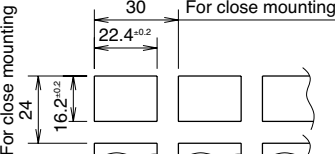
Item	Front View (mm)	Panel Cut-out Dimensions (mm)	Remarks
With Switch Guard			<p>N: No. of MA units mounted</p> <p>MA2 collective mounting Vertical: 4 rows max. Horizontal: 12 columns max.</p> <p>MA3 collective mounting Vertical: 4 rows max. Horizontal: 9 columns max.</p> <p>* Consider the strength of panel thickness. Panel thickness: 1 to 3.2 mm</p> <p>• The panel cut-out are the same as those required for guard barrier. Therefore, the switch guard and guard barrier can be used together for collective mounting.</p>
			
With Dust Cover			<p>N: No. of MA units mounted</p> <p>MA2 collective mounting Vertical: 4 rows max. Horizontal: 12 columns max.</p> <p>MA3 collective mounting Vertical: 4 rows max. Horizontal: 9 columns max.</p> <p>* Consider the strength of panel thickness. Panel thickness: 1 to 3.2 mm</p>
			

## Safety Precautions

- Turn off power to the MA unit before installation, removal, wiring, maintenance, and inspection. Failure to turn power off may cause electrical shocks or fire hazard.
- When replacing LED units, use the optional lens removal tool (MT-101), plier, or screwdriver to prevent burns.
- Use the MA unit within the rated values, otherwise electrical shocks or fire hazard may occur.
- For wiring, use wires of proper size to meet the voltage and current requirements.
- Improper soldering or failure to tighten the terminal screw may cause overheating and fire.
- Use the optional locking ring wrench to mount the unit onto a panel.

## Instructions

### Mounting/Removal of the Lens and Marking Plate

#### Removal

Pull out the lens unit (lens, color screen, marking plate and lens holder) while pinching the recesses of the lens using the lens removal tool. (See photo 1)  
The marking plate can be removed by unlatching the lens from the lens holder. (See photo 2)

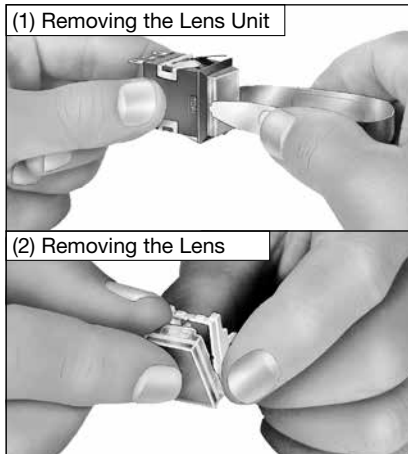
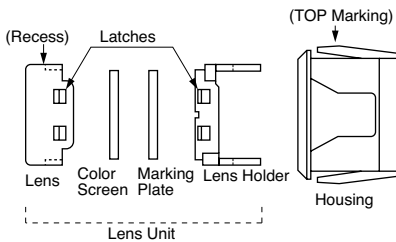

#### Installation

Put the color screen and marking plate into the lens, then press the lens holder into the lens. Make sure to install the lens unit into the housing in the correct direction.

#### Mounting Order of Color Screen and Marking Plate

Insert the color screen and the marking plate in the following order, depending on the application.

Display Color (Lamp OFF)	Insertion Order
Color [Initial condition]	A Lens ↓ Color Screen ↓ Marking Plate ↓ Housing
White	B Lens ↓ Marking Plate ↓ Color Screen ↓ Housing

#### Notes:

1. For white illumination, the display color in OFF status is white, regardless of the mounting order of A or B.
2. Both marking plate and color screen can be engraved.
3. The Two-color Alternate (Red ↔ Green) illumination type uses two marking plates, without using a color screen.

### LED Unit

#### Mounting/Removal of the LED Unit

Remove the LED unit from the housing using the lens removal tool, plier, or screwdriver. To mount the LED unit, insert the LED unit into the housing first, and then insert the lens unit into the housing. In this step, be careful about orientation of each unit. When inserting the LED unit, align the TOP marking on the LED unit with the TOP marking on the housing. Inserting the LED unit in an incorrect orientation may cause damage to the contacts on the LED unit.

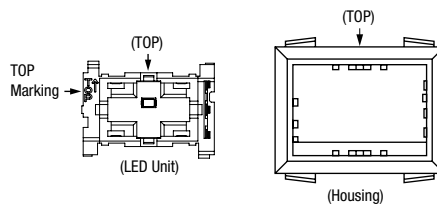

Also for accessories and maintenance parts, a protective seal is attached to spare LED units to prevent static electricity from being applied to the metal frame cut part. Remove the protective seal immediately before replacing LED units.

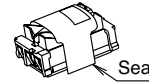

Do not touch the metal frame cut part. Otherwise, damage or malfunction may occur.



#### LED Unit Voltage Marking

When mounting or removing the LED unit, make sure that the operational voltage is correct. The operational voltage is indicated by a number on the LED unit.

Voltage Indication Number	LED Unit Operational Voltage
1	5V DC ±5%
3	12V AC/DC ±5%
4	24V AC/DC ±5%

### Installation of Accessories

#### Installing the Barrier

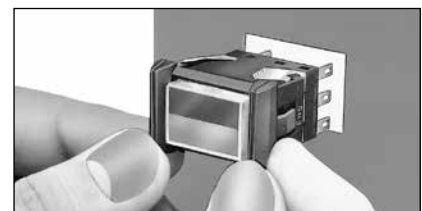

#### Single mounting

Put end barriers on both sides of the MA unit, insert it from the front of the panel.

Instructions

**Collective mounting**

Insert end barriers at both ends of MA units, insert them into the panel cut-out. After mounting the MA units into the panel, insert the spacer barrier between the MA units.

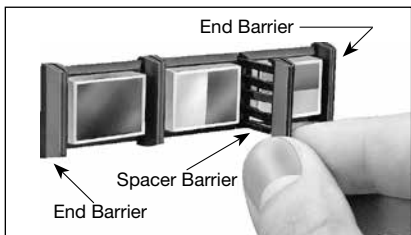

**Installing the Switch Guard**

Install the switch guard before mounting into a panel cut-out. To install switch guard, place the hinge of the switch guard upward, and depress the switch guard onto the flange of the MA unit.

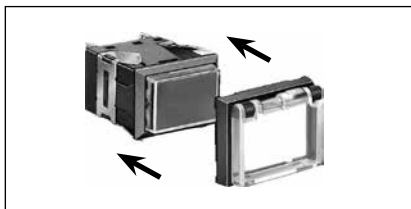

**Installing the Socket**

Align the TOP marking of the MA unit with that of the socket, and press the socket onto the MA unit.

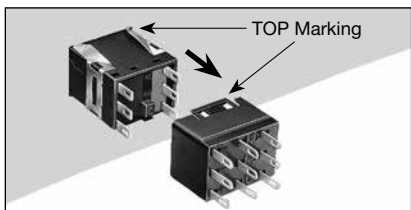

**Installation of the Guard Barrier**

Install the guard barrier before mounting into a panel cut-out. To install the guard barrier, orientate the notch of guard barrier downward, and depress the guard barrier onto the bezel of the MA unit.

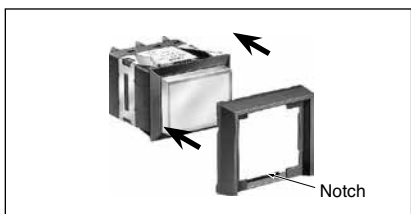

**Installation of the Dustproof Cover**

Separate the cap (translucent rubber) and the base (black plastic). (See Photo 1) Install the base from the MA unit terminal side onto the bezel. (See Photo 2) In this step, make sure that the base is placed between the bezel and the leaf springs. Then, mount the MA unit into the panel cut-out, and mount the cap onto the base. Make sure that the cap is fitted to the base.

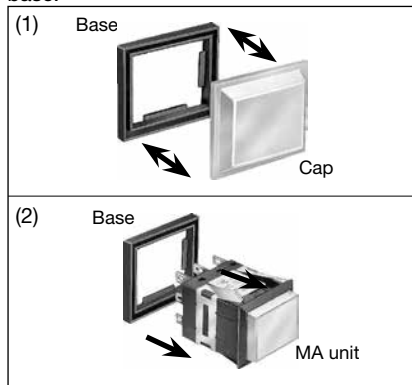

**Installation of Leaf Springs for Vertical Mounting**

First, insert a small flat-blade screwdriver under the leaf spring on the MA unit, and remove the leaf spring for horizontal mounting.

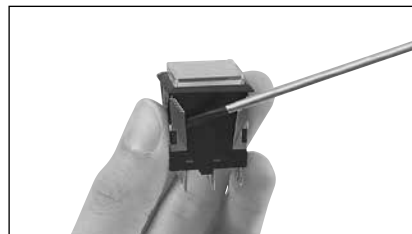

Place the vertical leaf spring on the MA unit temporarily, and then press the spring until it is secured on the MA unit.



**Wiring Precautions**

- Solder the terminals at 350°C within 3 seconds, using a 60W soldering iron. Sn-Ag-Cu solder is recommended. While soldering, keep the soldering iron as far from the plastic part of the switch as possible. Do not apply external force to the switch unit. Do not bend the terminals, pull the cable, etc. To use a soldering iron, check your actual operating conditions.
- Use a non-corrosive, liquid rosin soldering flux.
- Among the LED terminals, the center terminal on a one-color full illuminated unit is a dummy.
- A current limiting resistor is incorporated in all LED units.

**Operating Instructions**

**LED Operating Voltage (5V DC)**

The rated operating voltage is based on a pure direct current source. To use the LED under rectified DC, make sure that the peak voltage does not exceed the rated DC operating voltage. If the peak voltage exceeds the rated DC operating voltage, the LED life may be shortened.

**Microswitch Contacts**

When using both the NO and NC contacts of the same microswitch, avoid connections of different voltages, or connections of different power supply types. Failure to observe this instruction may cause a short-circuit.

**Operating and Storage Conditions**

Use the MA unit in an environment within the rated operating temperature and humidity range. Do not use the MA unit in a place where it is subjected to oil or water splashes, or in a place with dust accumulation.

**New Super Bright LED Units**

To accommodate the new super bright LED unit, the MA2 unit has no protrusion inside. If your MA unit has a protrusion inside, it is an older type and the new LED unit cannot be used. If the new LED unit is used with the old MA unit, the LED may fail to light.

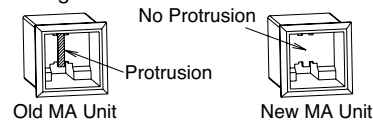



# Ordering Terms and Conditions

Thank you for using IDEC Products.

By purchasing products listed in our catalogs, datasheets, and the like (hereinafter referred to as "Catalogs") you agree to be bound by these terms and conditions. Please read and agree to the terms and conditions before placing your order.

## 1. Notes on contents of Catalogs

- (1) Rated values, performance values, and specification values of IDEC products listed in this Catalog are values acquired under respective conditions in independent testing, and do not guarantee values gained in combined conditions.  
Also, durability varies depending on the usage environment and usage conditions.
- (2) Reference data and reference values listed in Catalogs are for reference purposes only, and do not guarantee that the product will always operate appropriately in that range.
- (3) The specifications / appearance and accessories of IDEC products listed in Catalogs are subject to change or termination of sales without notice, for improvement or other reasons.
- (4) The content of Catalogs is subject to change without notice.

## 2. Note on applications

- (1) If using IDEC products in combination with other products, confirm the applicable laws / regulations and standards.  
Also, confirm that IDEC products are compatible with your systems, machines, devices, and the like by using under the actual conditions. IDEC shall bear no liability whatsoever regarding the compatibility with IDEC products.
- (2) The usage examples and application examples listed in Catalogs are for reference purposes only. Therefore, when introducing a product, confirm the performance and safety of the instruments, devices, and the like before use. Furthermore, regarding these examples, IDEC does not grant license to use IDEC products to you, and IDEC offers no warranties regarding the ownership of intellectual property rights or non-infringement upon the intellectual property rights of third parties.
- (3) When using IDEC products, be cautious when implementing the following.
  - i. Use of IDEC products with sufficient allowance for rating and performance
  - ii. Safety design, including redundant design and malfunction prevention design that prevents other danger and damage even in the event that an IDEC product fails
  - iii. Wiring and installation that ensures the IDEC product used in your system, machine, device, or the like can perform and function according to its specifications
- (4) Continuing to use an IDEC product even after the performance has deteriorated can result in abnormal heat, smoke, fires, and the like due to insulation deterioration or the like. Perform periodic maintenance for IDEC products and the systems, machines, devices, and the like in which they are used.
- (5) IDEC products are developed and manufactured as general-purpose products for general industrial products. They are not intended for use in the following applications, and in the event that you use an IDEC product for these applications, unless otherwise agreed upon between you and IDEC, IDEC shall provide no guarantees whatsoever regarding IDEC products.
  - i. Use in applications that require a high degree of safety, including nuclear power control equipment, transportation equipment (railroads / airplanes / ships / vehicles / vehicle instruments, etc.), equipment for use in outer space, elevating equipment, medical instruments, safety devices, or any other equipment, instruments, or the like that could endanger life or human health
  - ii. Use in applications that require a high degree of reliability, such as provision systems for gas / waterworks / electricity, etc., systems that operate continuously for 24 hours, and settlement systems
  - iii. Use in applications where the product may be handled or used deviating from the specifications or conditions / environment listed in the Catalogs, such as equipment used outdoors or applications in environments subject to chemical pollution or electromagnetic interference  
If you would like to use IDEC products in the above applications, be sure to consult with an IDEC sales representative.

## 3. Inspections

We ask that you implement inspections for IDEC products you purchase without delay, as well as thoroughly keep in mind management/maintenance regarding handling of the product before and during the inspection.

## 4. Warranty

- (1) Warranty period  
The warranty period for IDEC products shall be one (1) year after purchase or delivery to the specified location. However, this shall not apply in cases where there is a different specification in the Catalogs or there is another agreement in place between you and IDEC.
- (2) Warranty scope  
Should a failure occur in an IDEC product during the above warranty period for reasons attributable to IDEC, then IDEC shall replace or repair that product, free of charge, at the purchase location / delivery location of the product, or an IDEC service base. However, failures caused by the following reasons shall be deemed outside the scope of this warranty.
  - i. The product was handled or used deviating from the conditions / environment listed in the Catalogs
  - ii. The failure was caused by reasons other than an IDEC product
  - iii. Modification or repair was performed by a party other than IDEC
  - iv. The failure was caused by a software program of a party other than IDEC
  - v. The product was used outside of its original purpose
  - vi. Replacement of maintenance parts, installation of accessories, or the like was not performed properly in accordance with the user's manual and Catalogs
  - vii. The failure could not have been predicted with the scientific and technical standards at the time when the product was shipped from IDEC
  - viii. The failure was due to other causes not attributable to IDEC (including cases of force majeure such as natural disasters and other disasters)Furthermore, the warranty described here refers to a warranty on the IDEC product as a unit, and damages induced by the failure of an IDEC product are excluded from this warranty.

## 5. Limitation of liability

The warranty listed in this Agreement is the full and complete warranty for IDEC products, and IDEC shall bear no liability whatsoever regarding special damages, indirect damages, incidental damages, or passive damages that occurred due to an IDEC product.

## 6. Service scope

The prices of IDEC products do not include the cost of services, such as dispatching technicians. Therefore, separate fees are required in the following cases.

- (1) Instructions for installation / adjustment and accompaniment at test operation (including creating application software and testing operation, etc.)
- (2) Maintenance inspections, adjustments, and repairs
- (3) Technical instructions and technical training
- (4) Product tests or inspections specified by you

The above content assumes transactions and usage within your region. Please consult with an IDEC sales representative regarding transactions and usage outside of your region. Also, IDEC provides no guarantees whatsoever regarding IDEC products sold outside your region.

# IDEC CORPORATION

**Head Office** 6-64, Nishi-Miyahara-2-Chome, Yodogawa-ku, Osaka 532-0004, Japan

 [www.idec.com](http://www.idec.com)

**USA** IDEC Corporation  
**EMEA** APEM SAS

**Singapore** IDEC Izumi Asia Pte. Ltd.  
**Thailand** IDEC Asia (Thailand) Co., Ltd.  
**India** IDEC Controls India Private Ltd.

**China** IDEC (Shanghai) Corporation  
IDEC Izumi (H.K.) Co., Ltd.  
**Taiwan** IDEC Taiwan Corporation

**Japan** IDEC Corporation

Specifications and other descriptions in this brochure are subject to change without notice.

2023 IDEC Corporation, All Rights Reserved.

