



INSTRUCTION SHEET

Original Instructions
Solenoid Type Interlock Switch
HS1C Series



Thank you for purchasing this IDEC product. Confirm that the delivered product is what you have ordered. Read this instruction sheet to make sure of correct operation.

SAFETY PRECAUTIONS

In this operation instruction sheet, safety precautions are categorized in order of importance to Warning and Caution :

WARNING

Warning notices are used to emphasize that improper operation may cause severe personal injury or death.

CAUTION

Caution notices are used where inattention might cause personal injury or damage to equipment.

1 Type

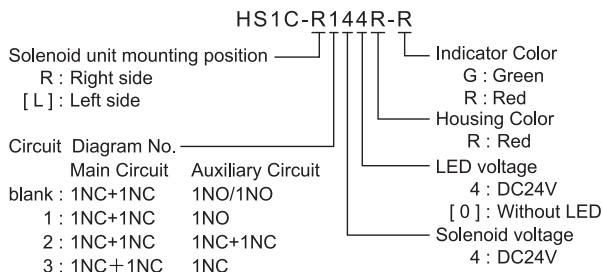

*1 Type Nos. in [] are not supplied as standard. Contact IDEC if required.

2 Specifications and Ratings

Applicable Standards	EN ISO / ISO14119 IEC60947-5-1, EN60947-5-1 GS-ET-19, UL508 CSA C22.2 No.14, GB/T14048.5																																																
Standards for Use	IEC60204-1/ EN60204-1																																																
Applicable Directives	Low Voltage Directive, Machinery Directive, RoHS Directive																																																
Operating Condition	Operating Temperature -25 to +50°C (no freezing) Operating Humidity 45 to 85%RH (no condensation) Pollution Degree 3 Altitude 2,000m maximum																																																
Impulse withstand voltage <Uimp>	4kV (Between ground and LED, solenoid circuit : 2.5kV)																																																
Raed Insulation voltage <Ui>	300V (Between ground and LED, solenoid circuit : 60V)																																																
Thermal Current <Ith>	Main Circuit : 10A, Auxiliary Circuit : 3A																																																
Contact Ratings (Reference Values) <I _{ue} , I _e >	<table border="1"> <thead> <tr> <th></th> <th></th> <th></th> <th>30V</th> <th>125V</th> <th>250V</th> </tr> </thead> <tbody> <tr> <td rowspan="4">Main Circuit</td> <td>A</td> <td>Resistive load (AC-12)</td> <td>10A</td> <td>10A</td> <td>6A</td> </tr> <tr> <td>C</td> <td>Inductive load (AC-15)</td> <td>10A</td> <td>5A</td> <td>3A</td> </tr> <tr> <td>D</td> <td>Resistive load (DC-12)</td> <td>6A</td> <td>-</td> <td>-</td> </tr> <tr> <td>C</td> <td>Inductive load (DC-13)</td> <td>3A</td> <td>0.9A</td> <td>-</td> </tr> <tr> <td rowspan="4">Auxiliary Circuit</td> <td>A</td> <td>Resistive load (AC-12)</td> <td>-</td> <td>3A</td> <td>3A</td> </tr> <tr> <td>C</td> <td>Inductive load (AC-15)</td> <td>-</td> <td>-</td> <td>3A</td> </tr> <tr> <td>D</td> <td>Resistive load (DC-12)</td> <td>3A</td> <td>-</td> <td>-</td> </tr> <tr> <td>C</td> <td>Inductive load (DC-13)</td> <td>3A</td> <td>0.9A</td> <td>-</td> </tr> </tbody> </table>				30V	125V	250V	Main Circuit	A	Resistive load (AC-12)	10A	10A	6A	C	Inductive load (AC-15)	10A	5A	3A	D	Resistive load (DC-12)	6A	-	-	C	Inductive load (DC-13)	3A	0.9A	-	Auxiliary Circuit	A	Resistive load (AC-12)	-	3A	3A	C	Inductive load (AC-15)	-	-	3A	D	Resistive load (DC-12)	3A	-	-	C	Inductive load (DC-13)	3A	0.9A	-
			30V	125V	250V																																												
Main Circuit	A	Resistive load (AC-12)	10A	10A	6A																																												
	C	Inductive load (AC-15)	10A	5A	3A																																												
	D	Resistive load (DC-12)	6A	-	-																																												
	C	Inductive load (DC-13)	3A	0.9A	-																																												
Auxiliary Circuit	A	Resistive load (AC-12)	-	3A	3A																																												
	C	Inductive load (AC-15)	-	-	3A																																												
	D	Resistive load (DC-12)	3A	-	-																																												
	C	Inductive load (DC-13)	3A	0.9A	-																																												
Class of Protection	Class I (IEC61140) *2																																																
Operating Frequency	900 operations/hour																																																
Operating Speed	0.05 to 1.0 m/s																																																
B10d	2,000,000 (EN ISO 13849-1 Annex C Table C.1)																																																
Mechanical Durability	1,000,000 operations min. (GS-ET-19)																																																
Electrical Durability	100,000 operations min. (AC-12 250V*6A) 1,000,000 operations min. (AC/DC 24V 100mA) (900 operations / hour)																																																
Shock Resistance	Damage Limits : 1,000m/s ²																																																
Vibration Resistance	Operating Extremes : 10 to 55Hz, half amplitude 0.5mm Damage Limits : 30Hz, half amplitude 1.5mm																																																
Actuator Tensile Strength when Locked	Fzh=1,500N minimum F1max.=1,950N minimum (GS-ET-19) *3, *4																																																
Direct Opening Travel	11 mm minimum																																																
Direct Opening Force	20 N minimum																																																
Contact Resistance	100 mΩ maximum (Initial value)																																																
Degree of Protection	IP67 (IEC60529)																																																

Conditional short circuit current	100A(250V)	
Short-Circuit Protective Device	250V AC, 10A fast acting type fuse	
Solenoid	Rated Operating Voltage	24VDC
	Rated Current	415mA
	Turn ON Voltage	Rated Voltage × 85% maximum (at 20°C)
	Turn OFF Voltage	Rated Voltage × 10% minimum (at 20°C)
	Rated Power Consumption	Approx. 10W
Indicator	Rated Operating Voltage	24VDC
	Rated Current	10mA
	Light Source	LED lamp
	Illumination Color	R(Red), G(Green) (Φ12Lens)

Ratings approved by safety agencies

- | | | |
|----------------------------------|--|--|
| (1) TÜV rating
AC-15 250V, 3A | (2) UL, c-UL rating
3A, 250V ac, General Use
3A, 30V dc, Resistive | (3) CCC rating
AC-15 250V, 3A
DC-13 125V, 0.9A |
|----------------------------------|--|--|

*2 Basic insulation of 4kV impulse withstand voltage is ensured between different contact circuits and between contact circuits and LED or solenoid in the enclosure. When both SELV (safety extra low voltage) or PELV (protective extra low voltage) circuits and other circuits (such as 230V AC circuits) are used for the solenoid power and contact circuits at the same time, the SELV or PELV requirements are not met any more.

*3 The actuator locking strength is rated at 1,500N of static load. Do not apply a load higher than the rated value. When a higher load is expected to work on the actuator, provide an additional system consisting of another interlock switch without lock (such as the HS5D interlock switch) or a sensor to detect door opening and stop the machine.

*4 F1max. is maximum force. The actuator's guard-locking force Fzh is calculated in accordance with GS-ET-19 :

$$F_{zh} = \frac{\text{maximum force (F1max.)}}{\text{Safety coefficient (=1.3)}}$$

3 Mounting Examples

• Install the interlock switch on the immovable machine or guard, and install the actuator on the movable door. Do not install both interlock switch and actuator on the movable door, otherwise the angle of insertion of the actuator to the interlock switch may become inappropriate, and failure will occur.

(Examples of Mounting on Sliding Doors)

(Examples of Mounting on Hinged Doors)

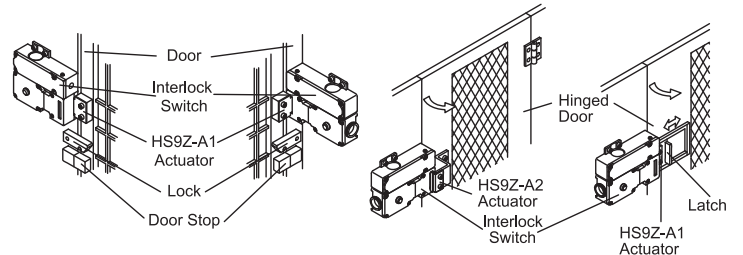

Minimum Radius of Hinged Door

When using the interlock switch for a hinged door, the minimum radius of the applicable door is shown in the following figures.

When the center of the hinged door is on the extension line of the actuator mounting surface.

When the center of the hinged door is on the extension line of the contact surface of actuator and interlock switch.

• L-shaped actuator : HS9Z-A2

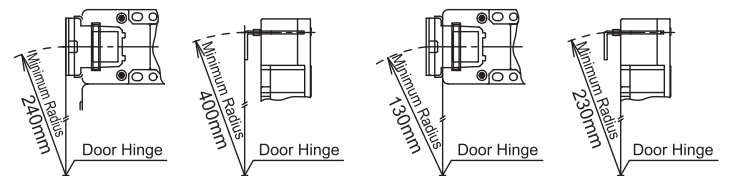

• Adjustable actuator : HS9Z-A3

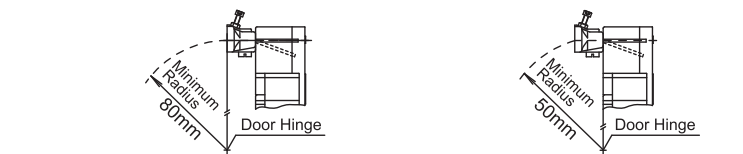

CAUTION

The figures shown above are based on the condition that the actuator enters and exits the actuator entry slot smoothly when the door is closed or opened. Since there may be deviation or dislocation of the hinged door, make sure of correct operation in the actual application before installation.

Actuator Mounting Reference Position

As shown below, the mounting reference position of the actuator inserted into the interlock switch is the actuator cover or stop film touches the interlock switch lightly. (After mounting the actuator, remove the actuator cover or stop film from the interlock switch.)

Note : During installation, ensure that there is no excess force applied between the interlock switch and actuator by installing a door stopper as shown in the image.

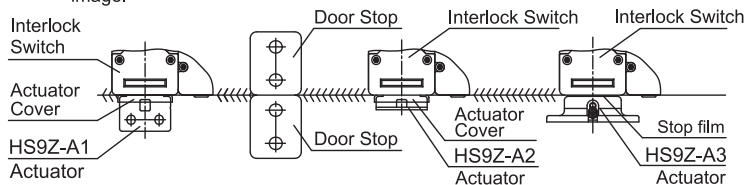

Actuator Mounting Tolerance

Mounting tolerance of the actuator is 1.0mm from the center of the actuator to up, down, right, and left.

Make sure the actuator can be inserted into the entry slot without any issue.

Actuator can move 3.8mm (HS9Z-A1 and -A2) / 2.7mm (HS9Z-A3) from the mounting position without affecting the contact operation.

$$\left(\text{Deviation of actuator position} \right) + \left(\text{Deviation of door position} \right) \leq 3.8 / 2.7 \text{ mm}$$

When closing the door (when actuator is inserted into interlock switch), the solenoid is locked as the actuator has reached at approx. 6.4mm (HS9Z-A1 and -A2) / 5.3mm (HS9Z-A3) to the mounting reference position.

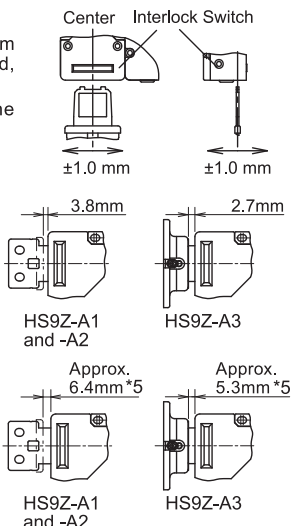

CAUTION

*5 To ensure that the door locks correctly, install the actuator in a position that is within 6.4 mm (HS9Z-A1 and -A2) / 5.3 mm (HS9Z-A3) of the standard installation position. If the actuator is not in the correct position, the door will not lock and there is a risk that an incorrect safety circuit may turn ON.

Recommended Screw Tightening Torque

Name or Use	Screw Tightening Torque
For mounting the interlock switch (M5 hexagon socket head cap screw) *6	4.5~5.5 N·m
For mounting the actuator (M6 hexagon socket head cap screw) *6	4.5~5.5 N·m
For mounting the lid (M4)	1.1~1.3 N·m
Connector (G1/2)	2.7~3.3 N·m
Plug for Unused Conduit Hole (G1/2)	1.8~2.2 N·m
Screw Terminal No.1 to 6 (M3)	0.4~0.6 N·m
Screw Terminal No.7,8 (M3.5)	0.9~1.1 N·m
Ground Terminal screw (M4)	0.9~1.1 N·m
Angle adjusting screw of HS9Z-A3 (M3 hexagon socket head cap screw)	0.8 N·m

CAUTION

*6 When the torque is not enough to recommended screw tightening torque, make sure that the screw do not become loose by using adhesive sealants etc. to keep right operation and mounting positioning.

Adjusting the Angle Adjustable Actuator (HS9Z-A3)

Using the angle adjusting screw (M3 hexagon socket head screw), the actuator angle can be adjusted up to 20°.

The larger the actuator angle, the smaller the applicable radius of the door swing. After installing the actuator, open the door. Then adjust the actuator angle so that the actuator enters the entry slot of the interlock switch properly.

After adjusting the actuator angle, apply loctite or the like on the adjusting screw to prevent loosening.

Installing the slot plug (In the case of a standard sale item. Please check other models.)

When not in use, close up the interlock switch actuator entry slots with slot plugs to prevent dust from entering.

The actuator entry slot vertical to the mounting panel come closed up with slot plugs at time of shipment.

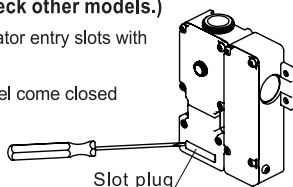

4 Instruction

Installation

- Do not apply an excessive shock to the interlock switch when opening or closing the door. A shock to the interlock switch exceeding 1,000 m/s² may cause failure.
- Provide a door guide, and ensure that force is applied on the interlock switch only in the actuator insertion direction.
- Do not pull the actuator while it is locked. Also, regardless of door types, do not use the interlock switch as a door lock. Install a separate lock as shown in item 3.
- When opening the interlock switch lid to wire, open the lid 1 only. (See the figure on the right.) Never remove other screws, otherwise the interlock switch may be damaged.
- The interlock switch cover can be only removed or installed with the special L-shaped key wrench supplied with the switch.
- Make sure to install the product in a place where it cannot be damaged. Make sure to conduct a proper risk assessment evaluation before using the product, and use a shield or a cover to protect the product if need be.
- Solenoid has polarity. Be sure to wire correctly. Do not apply voltage that exceed the rated voltage, otherwise the solenoid will be burnt out.
- Avoid foreign objects such as dust, liquid, and oil from entering the switch while connecting a conduit or wiring.
- Entry of foreign objects in the actuator entry slot may affect the mechanism of the switch and cause a breakdown. If the operating atmosphere is contaminated, use a protective cover to prevent the entry of foreign objects into the switch through the actuator entry slots.
- Use only the designated actuator for the HS1C. Other actuators will cause a breakdown of the switch.

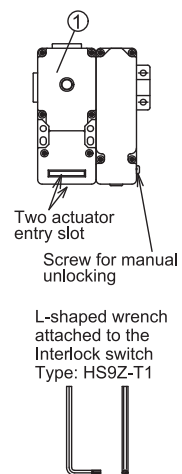

WARNING

- Turn off the power to the interlock switch before starting installation, removal, wiring, maintenance, and inspection on the Interlock switch. Failure to turn power off may cause electrical shocks or fire hazard.
- Use wires of a proper size to meet voltage and current requirements. Tighten the terminal screws to a recommended tightening torque of 1.0N·m. Loose terminal screws will cause unexpected heating and fire hazard during operation.

CAUTION

- Regardless of door types, do not use the interlock switch as a door stop. Install a mechanical door stop at the end of the door to protect the interlock switch against an excessive force.
- Mount the actuator so that it will not hit the operator when the door is open, otherwise injury may be caused.
- Pay attention to the management of spare actuator. Safety function of door interlock switch will be lost in case the spare actuator is inserted into the interlock switch. Ensure that the actuator is firmly fastened to the door (welding, rivet, special screw) in the appropriate location, so that the actuator cannot be removed easily.
- Do not cut or remodel the actuator, otherwise failure will occur.
- If multiple safety components are wired in series, the Performance Level to ISO13849-1 will be reduced due to the restricted error detection under certain circumstance.
- The insulation of the cable has to withstand environmental influences.
- The entire concept of the control system, in which the safety component is integrated, must be validated to ISO13849-2.

Manual Unlocking

- The HS1C allows manual unlocking of the actuator to precheck door operation before wiring or turning on power, as well as for emergency use such as a power failure.
- Remove the screw from the side of the interlock switch using the wrench for mounting the lid. Push the lever inside the interlock switch towards the pilot light using a small screwdriver until the actuator is unlocked. See the figure on the right.

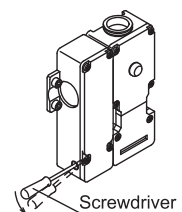

CAUTION

- Before manually unlocking the interlock switch, make sure the machine has come to a complete stop. Manual unlocking during operation may unlock the switch before the machine stops, and the function of interlock switch with solenoid is lost.
- After the unlocking operation, be sure to turn the screw to the original position for safety.

5 Contact Operation

Contact Configuration

Type	Contact Configuration *7		
	Indicator (+) 7 (-) 8	Door monitor	Lock monitor (+) 5 (-) 6
HS1C-R44R-□			
HS1C-R144R-□	Main Circuit : ⊕ 3 ⊖ 4 Monitor Circuit : 1 2		
HS1C-R244R-□	Main Circuit : ⊕ 3 ⊖ 4 Main Circuit : ⊕ 1 ⊖ 2		
HS1C-R344R-□	Main Circuit : ⊕ 3 ⊖ 4 Monitor Circuit : ⊕ 1 ⊖ 2		

CAUTION

*7 The Actuator is inserted, and HS1C is locked.

Operation Cycle

Type		Closed	Closed	Open
Type HS1C-□44R-□	Main Circuit	3-4 : Closed	3-4 : Open	3-4 : Open
	Auxiliary Circuit	1-2 : Open	1-2 : Closed	1-2 : Closed
	Solenoid Power	5-6 : Off	5-6 : On	5-6 : Off
Type HS1C-□144R-□	Main Circuit	3-4 : Closed	3-4 : Open	3-4 : Open
	Auxiliary Circuit	1-2 : Open	1-2 : Open	1-2 : Closed
	Solenoid Power	5-6 : Off	5-6 : On	5-6 : Off
Type HS1C-□244R-□	Main Circuit	3-4 : Closed	3-4 : Open	3-4 : Open
	Auxiliary Circuit	1-2 : Closed	1-2 : Open	1-2 : Open
	Solenoid Power	5-6 : Off	5-6 : On	5-6 : Off
Type HS1C-□344R-□	Main Circuit	3-4 : Closed	3-4 : Open	3-4 : Open
	Auxiliary Circuit	1-2 : Closed	1-2 : Closed	1-2 : Open
	Solenoid Power	5-6 : Off	5-6 : On	5-6 : Off
		• Door is locked. • The machine can be operated.	• Door is unlocked. • The machine can not be operated.	• The machine can not be operated.

• Recommendation tools (sold separately)

6 Wiring

Wire Length inside the Interlock Switch

Screw Terminal No.	Through Conduit Hole		
	①	②	③
1	30±2	45±2	70±2
2	30±2	50±2	65±2
3	25±2	55±2	60±2
4	25±2	60±2	55±2
5	30±2	65±2	50±2
6	30±2	70±2	45±2
7	65±2	35±2	110±2
8	65±2	110±2	35±2
E	85±2	45±2	45±2

Wire Length : L1 (mm)

Wire Stripping Length : L2 (mm) 7±1

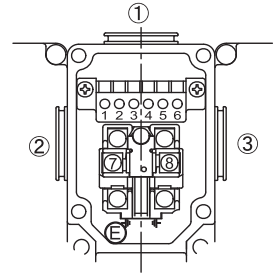

Recommended Wire Core Size

Screw Terminal No. 1, 2, 5, 6, 7, 8 : 0.5 to 0.75 mm²
 Screw Terminal No. 3, 4, E : 1.0 to 1.25 mm²

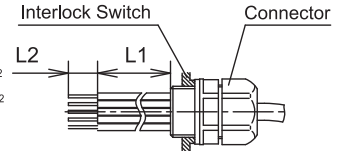

Applicable Crimping Terminal

Screw Terminal No. 1 to 6 : Direct Wiring Using a solid or stranded wire

Note : When using a stranded wire, make sure that adjoining terminals are not short-circuited with protruding core wires. Also, do not solder the core wires to avoid protruding wires.

<Ferrules> : Recommended ferrules

Applicable wire (stranded) mm ²	AWG	Part No.
0.75	18	S3TL-H075-14WW
1	17	S3TL-H10-14WY
1.5	16	S3TL-H15-14WR

• Recommendation tools (sold separately)

Name	Part No.	Note
Crimping tool	S3TL-CR06D	Overseas limited sale

Screw Terminal No. 7,8:
Terminal Screw (M3.5)

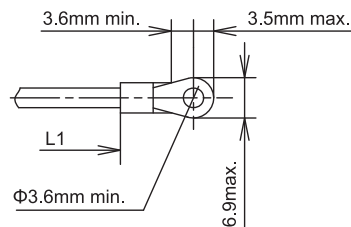

Screw Terminal No. E:
Ground Terminal Screw (M4)

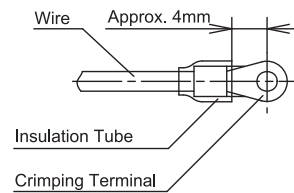
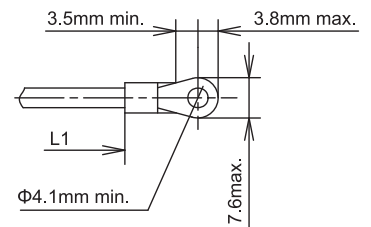

Note : Make sure to use an insulation tube on the crimping terminal.

Applicable Connectors

Use a connector with a degree of protection IP67.

• When using plastic connector, metal connector and multi-core cable (G1/2)

Applicable Plastic Connector Example
: Type SCS-10□ (made by Seiwa Electric)

Applicable Metal Connector Example

: Type C20G-□□16 (made by SANKEI MANUFACTURING)

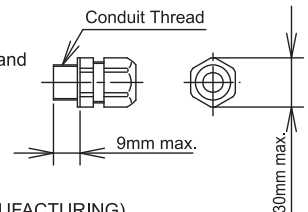

Note : Confirm the outside diameter of the multi-core cable, the connector type depends on the outside diameter of multi-core cable.

7 Example of wiring Diagram realizing Safety Category

Example of a circuit diagram for Safety Category 3 (attainable PL = d)

(Condition 1: To apply the fault exclusion of mechanical structural parts including the actuator → Make sure to use the product within the product specification range described in this manual and the version of the manual provided with the product.)
(Condition 2: Documentation of the reason for the machine/equipment manufacturer to have applied the fault exclusion based on ISO13849-1, ISO13849-2 or IEC62061.)

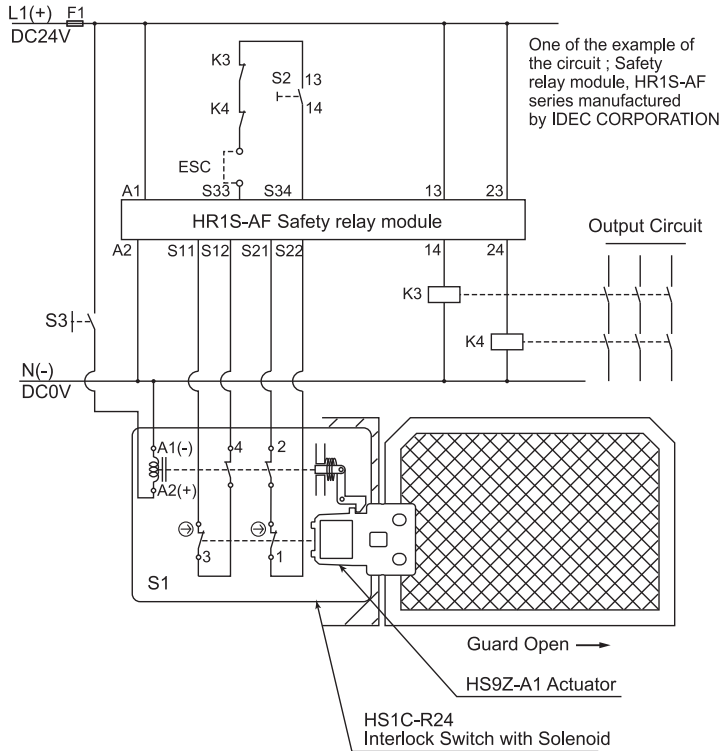

- S1: HS1C-R24 Interlock Switch with Solenoid
- S2: Start Switch (HW Series Momentary)
- S3: Unlocking Enabling Switch
- S4: Safety limit Switch
- ESC: Outside start condition
- K3, 4: Safety Contactor
- F1: Outside fuse of safety relay module at power supply line

Example of a circuit diagram for Safety Category 4 (attainable PL = e)

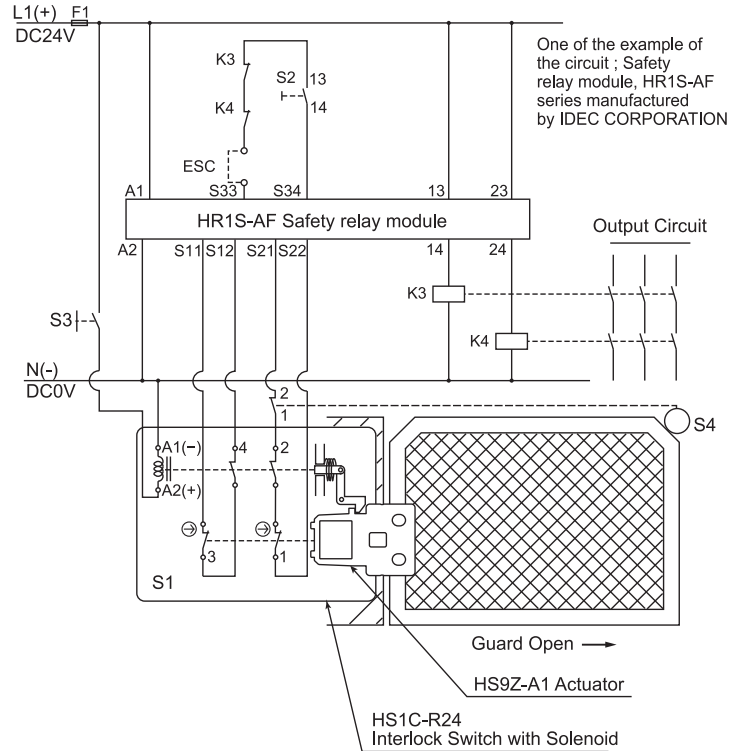

Note: Use the monitoring device(Safety relay module) provided the capability to detect a cross short circuit. The insulation of the cable has to withstand environmental influences. If a control device other than the one shown in the draft is used, the used control device has to be equipped with a cross short circuit monitor.

8 Dimensions (mm)

Interlock Switch dimensions

Type : HS1C-R□44R-□

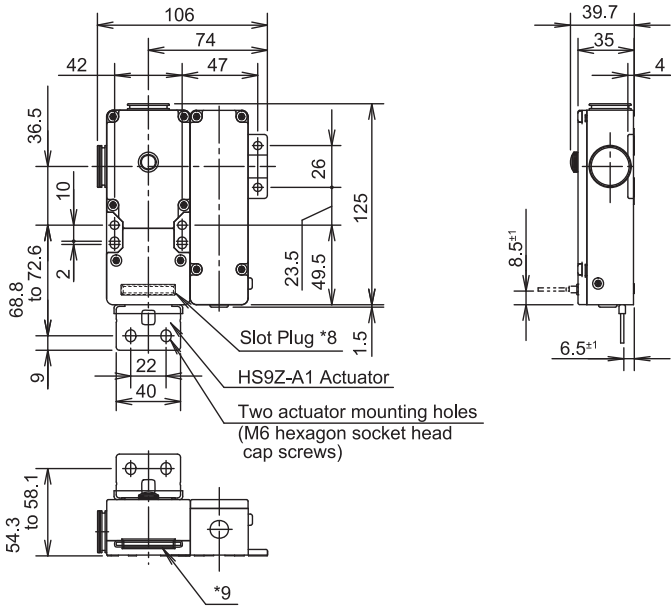

*8 The actuator entry slot vertical to the mounting panel
 *9 The actuator entry slot horizontal to the mounting panel
 Note: When not in use, close up the interlock switch actuator entry slots with slot plugs to prevent dust from entering.
 (The actuator entry slot vertical to the mounting panel come closed up with slot plugs at time of shipment.
 In the case of a standard sale item. Please check other models.)

Main body mounting hole layout

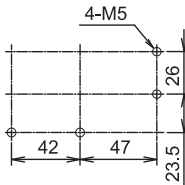

Type : HS1C-L□44R-□

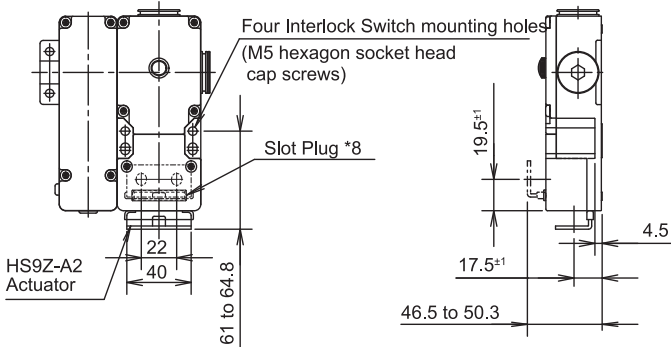

Main body mounting hole layout

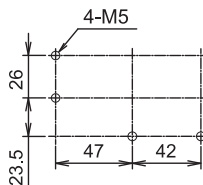

Accessories dimensions

Type : HS9Z-A1

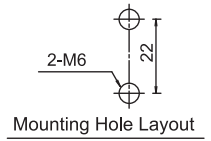
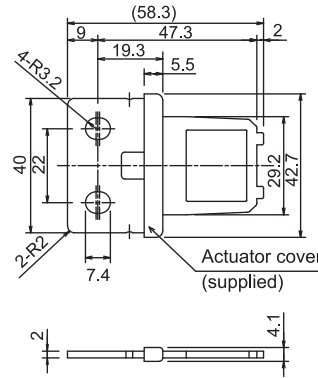

Type : HS9Z-A2

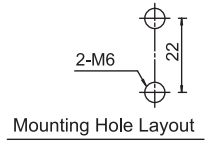
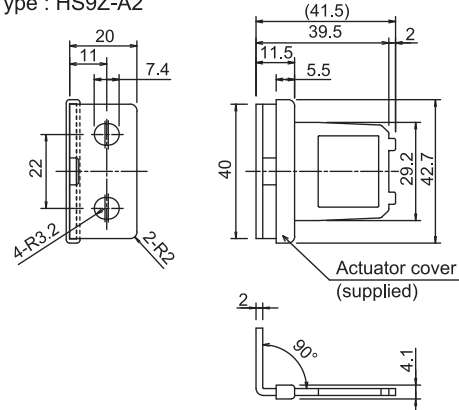

Type : HS9Z-A3

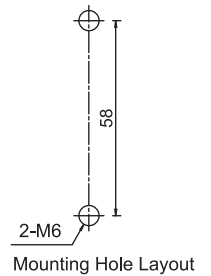
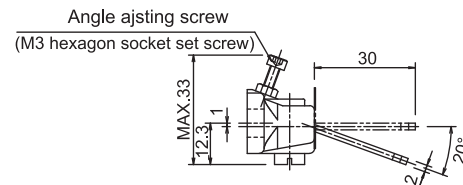
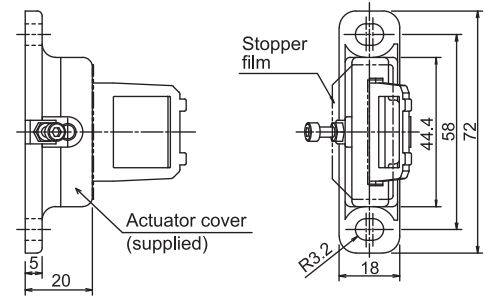

9 Precaution for Disposal

Dispose of the HS1C interlock switch as an industrial waste.

IDEC CORPORATION

<http://www.idec.com>

Manufacturer: IDEC CORP.
 2-6-64 Nishimiyahara Yodogawa-ku, Osaka 532-0004, Japan

EU Authorized Representative: APEM SAS
 55, Avenue Edouard Herriot BP1, 82303 Caussade Cedex, France

EU DECLARATION OF CONFORMITY
 We, IDEC CORPORATION 2-6-64, Nishimiyahara Yodogawa-ku, Osaka 532-0004, Japan declare under our sole responsibility that the product:

Description: Interlock Switch
 Model No: HS1C

Applied Union harmonized legislation and references to the relevant harmonization standards used or references the other technical specifications in relation to which conformity is declared.

Applicable EU Directive : Low Voltage Directive (2014/35/EU)
 Machinery Directive (2006/42/EC)
 RoHS Directive (2011/65/EU)

Applicable Standard(s) : EN 60947-5-1, GS-ET-19, EN 50581