

EB3L Relay Barriers

126 types of pilot lights and buzzers can be connected and used in Zone 0 areas. Illuminated pushbuttons and illuminated selector switches can be connected by combining with the EB3C relay barrier.

Explosion protection	
Lamp Barrier	[Exia] II C
Pilot Light (separate wiring)	Exia II CT6
Pilot Light (common wiring)	Exia II CT4
Illuminated Pushbutton	Exia II CT4
Illuminated Selector Switch	Exia II CT4
Buzzer (separate wiring)*	Exib II CT6

- IEC60079 compliant.
- 8- and 16-channel are available in common wiring, ideal for connection to PLCs. 16-circuit also available with a connector.
- Universal AC power voltage (100 to 240V AC)
- No grounding required.
- IDEC's original spring-up terminal minimizes wiring time.
- Installation
35-mm-wide DIN rail mounting or direct screw mounting.
- $\phi 6$, $\phi 8$, $\phi 10$, $\phi 22$ and $\phi 30$ pilot lights available.
- Illuminated pushbuttons and illuminated selector switches can be connected by combining with the EB3C relay barrier.
Illumination colors: Amber, blue, green, red, white, and yellow (pushlock turn reset: red only)
- Buzzers are available in intermittent and continuous sounds. $\phi 30$ mounting hole.
- Global usage
IECEX
USA: FM, UL
Europe: CE marking, ATEX
China: Ex-CCC
Korea: KCS
Taiwan: TS
Japan: TIIS
- Ship class: NK (Japan), KR (Korea)

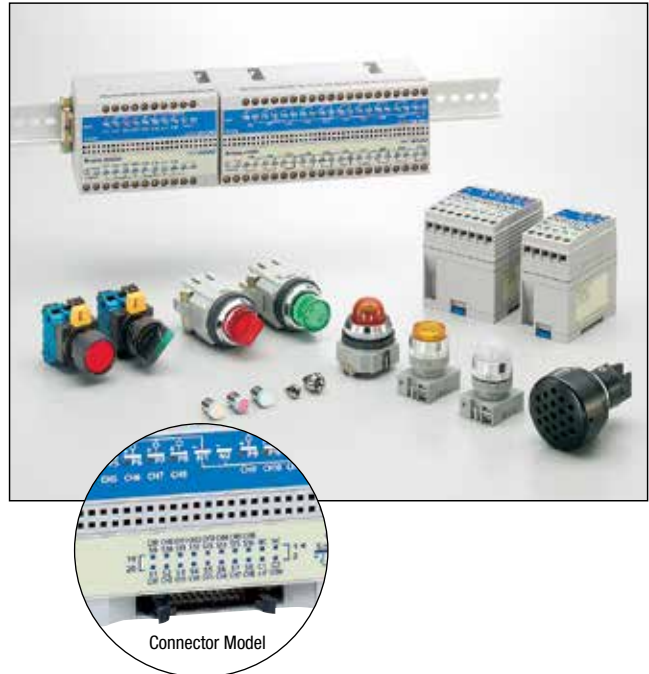

* Buzzers are certified by TIIS only. Other ex-proof certifications pending.
* Buzzers cannot be used in Zone 0 areas.

Lamp Barriers

Power Voltage	Connection to Non-intrinsically Safe Circuit	Input	Input Wiring Method (Note)	Number of Channels	Part No.	Weight (g)
100 to 240V AC	Screw Terminal	Source	Separate/Common Wiring Compatible	1	EB3L-S01SAN	150
				2	EB3L-S02SAN	180
				3	EB3L-S03SAN	190
				5	EB3L-S05SAN	250
				6	EB3L-S06SAN	260
				8	EB3L-S08SAN	330
				10	EB3L-S10SAN	360
		Common Wiring Only	8 (*)	EB3L-S08CSAN	260	
		Sink	Separate/Common Wiring Compatible	1	EB3L-S01KAN	150
				2	EB3L-S02KAN	180
				3	EB3L-S03KAN	190
				5	EB3L-S05KAN	250
				6	EB3L-S06KAN	260
				8	EB3L-S08KAN	330
10	EB3L-S10KAN			360		
Common Wiring Only	8 (*)	EB3L-S08CKAN	260			
24V DC	Screw Terminal	Source	Separate/Common Wiring Compatible	1	EB3L-S01SDN	130
				2	EB3L-S02SDN	160
				3	EB3L-S03SDN	170
				5	EB3L-S05SDN	240
				6	EB3L-S06SDN	250
				8	EB3L-S08SDN	310
				10	EB3L-S10SDN	250
		Common Wiring Only	8 (*)	EB3L-S08CSDN	340	
		16 (*)	EB3L-S16CSDN	350		
		Sink	Separate/Common Wiring Compatible	1	EB3L-S01KDN	130
				2	EB3L-S02KDN	160
				3	EB3L-S03KDN	170
				5	EB3L-S05KDN	240
				6	EB3L-S06KDN	250
	8			EB3L-S08KDN	310	
	10			EB3L-S10KDN	340	
	Common Wiring Only	8 (*)	EB3L-S08CKDN	250		
	16 (*)	EB3L-S16CKDN	350			
Connector	Source	Common Wiring Only	16 (*)	EB3L-S16CSD-CN	350	
	Sink		16 (*)	EB3L-S16CKD-CN	350	

* Buzzers cannot be connected in common wiring.

Note: Source input model can be connected with sink output PLC. Sink input model can be connected with source output PLC.

Accessories

Name	Part No.	Ordering No.	Package Quantity	Description
DIN Rail	BAA1000	BAA1000PN10	10	Aluminum (1m long)
End Clip	BNL6	BNL6PN10	10	For fastening EB3L units on the DIN rail.

Pilot Lights, Illuminated Pushbuttons, Illuminated Selector Switches, and Buzzers

Unit	Size	Series (Note 1)	Shape	Operation Mode	Contact	Ordering No. (Note 2)	Lens Color/ Illumination Color Code*	Operation				
Pilot Light	ø30	N	Dome	—	—	EB3P-LAN1-*	A: Amber G: Green R: Red S: Blue Y: Yellow	—				
			Square	—	—	EB3P-LUN3B-*						
			Rectangular w/Metal Bezel	—	—	EB3P-LUN4-*						
			Dome w/Diecast Sleeve	—	—	EB3P-LAD1-*						
	ø22	TW	Flush	—	—	EB3P-LAW1-*						
			Flush (Marking Type)	—	—	EB3P-LAW1B-*						
			Dome	—	—	EB3P-LAW2-*						
		HW	Square Flush (Marking Type)	—	—	EB3P-LUW1B-*						
			Round Flush	—	—	EB3P-LHW1-*						
			Dome	—	—	EB3P-LHW2-*						
	LW	Square Flush	—	—	EB3P-LHW4-*							
		Round	—	—	EB3P-LLW1-*							
		Square	—	—	EB3P-LLW2-*							
	Miniature Pilot Light	ø10	UP	Extended	—	—			IPL1-18-*	A: Amber G: Green R: Red Y: Yellow	—	
Coned				—	—	IPL1-19-*						
ø8		Flush		—	—	IPL1-87-*						
		Extended		—	—	IPL1-88-*						
ø6		Coned		—	—	IPL1-89-*						
		Flush		—	—	IPL1-67-*						
		Extended		—	—	IPL1-68-*						
		Coned		—	—	IPL1-69-*						
Illuminated Pushbutton		ø30		N	Extended	Momentary	1NO-1NC	EB3P-LBAN211-*	A: Amber G: Green R: Red S: Blue Y: Yellow			(Note 3)
						Maintained	1NO-1NC	EB3P-LBA0N211-*	(Note 4)			
	Mushroom		Pushlock Turn Reset		1NO-1NC	EB3P-LBAVN311-R	Red only	(Note 5)				
	ø22	TW	Extended	Momentary	1NO-1NC	EB3P-LBAW211-*	A: Amber G: Green R: Red S: Blue Y: Yellow	(Note 3)				
				Maintained	1NO-1NC	EB3P-LBA0W211-	(Note 4)					
		Mushroom	Pushlock Turn Reset	1NO-1NC	EB3P-LBAW411-R	Red only	(Note 5)					
		HW	Round	Momentary	1NO	EB3P-LBH1W110-*	(Note 3)					
				Maintained	1NO	EB3P-LBHA1W110-*	(Note 4)					
		LW	Round	Momentary	DPDT	EB3P-LBL1W1C2-*	(Note 3)					
	Maintained			DPDT	EB3P-LBL1W1C2-*	(Note 4)						
	Square		Momentary	DPDT	EB3P-LBL2W1C2-*	(Note 3)						
			Maintained	DPDT	EB3P-LBL2W1C2-*	(Note 4)						
	Illuminated Selector Switch (Note 3)	ø30	N	Round	2-position	1NO-1NC	EB3P-LSAN211-*	A: Amber G: Green R: Red S: Blue Y: Yellow	Maintained			
					3-position	2NO	EB3P-LSAN320-*		Maintained			
ø22		TW	Round	2-position	1NO-1NC	EB3P-LSAW211-*	Maintained					
				2-position, return from right	1NO-1NC	EB3P-LSAW2111-*	Spring return from right					
				3-position	2NO	EB3P-LSAW320-*	Maintained					
				3-position, return from right	2NO	EB3P-LSAW3120-*	Spring return from right					
				3-position, return from left	2NO	EB3P-LSAW3220-*	Spring return from left					
				3-position, 2-way return	2NO	EB3P-LSAW3320-*	2-way spring return					
HW		Round	2-position	1NO-1NC	EB3P-LSHW211-*	Maintained						
			3-position	2NO	EB3P-LSHW320-*	Maintained						
LW		Round	2-position	DPDT	EB3P-LSL1W2C2-*	Maintained						
			Round w/Square Bezel	3-position	DPDT	EB3P-LSL3W3C2-*	Maintained					
Buzzer		ø30	—	—	Continuous sound	—	EB3P-ZUN12CN		—	Approx. 3 Hz		
					Intermittent sound (approx. 3 Hz)	—	EB3P-ZUN12FN					

- Note 1: Codes N, TW, HW, LW, and UP are the series names of IDEC's switches and pilot lights.
 Note 2: Specify a color code in place of *.
 Note 3: Momentary operation mode—the contact operates when the button is pressed. When the button is released, the contact goes back to the original position.
 Note 4: Maintained operation mode—the contact operates when the button is pressed, and maintains the position even when the button is released.
 Re-pressing the button releases the contact.
 Note 5: Pushlock turn reset operation mode—the button is held depressed when pressed, and released by turning clockwise.
 Note 6: Illuminated selector switches have a knob operator.
 Note 7: Lamp barrier and relay barrier need to be connected when using the illuminated pushbutton and illuminated selector switch.

Accessories

Name	Ordering No.	Package Quantity	Remarks
LED Lamp	EB9Z-LDS1-*	1	Specify a color code in place of * in the Ordering No. A: amber, G: green, R: red, S: blue, W: white
Static Electricity Caution Plate	EB9Z-N1PN10	10	Polyester 20 (W) x 6 (H) mm

Note: Use a pure white (PW) LED lamp for yellow (Y) illumination.

Explosion-Protection and Electrical Specifications of Lamp Barrier

Explosion Protection	Intrinsic safety type		
Degree of Protection	IP20 (IEC60529)		
Installation Location	Lamp Barrier	Safe indoor place (non-hazardous area)	
	Pilot Light, Illuminated Switch	For zone 0, 1, 2 hazardous areas	
	Buzzer	For zone 1, 2 hazardous areas	
Non-intrinsically Safe Circuit Maximum Voltage (Um)	250V AC 50/60Hz, 250V DC		
Operation	Input ON, Output ON (1:1)		
Intrinsically Safe Circuits (Output)	Wiring Method	1-channel Separate Wiring	16-channel Common Wiring
	Rated Operating Voltage	12V DC	
	Rated Operating Current	10 mA DC ±20%	
	Maximum Output Voltage (Uo)	13.2V DC	
	Maximum Output Current (Io)	14.2 mA	227.2 mA
	Maximum Output Power (Po)	46.9 mW	750 mW
	Maximum External Capacitance (Co) (Note)	470 (470) nF	490 (365) nF
	Maximum External Inductance (Lo) (Note)	87.5 (87.5) mH	0.6 (0.425) mH
	Allowable Wiring Resistance (Rw)	200/(n+1)Ω (n = number of common channels)	
	Maximum Channels per Common Line	8 (16 maximum)	
Voltage and Current when Connecting Control Units	Pilot light: 3.5V, 8.5 mA Miniature pilot light: 2V, 10 mA Illuminated switch: 3.5V, 8.5 mA Buzzer: 6.5V, 5.5 mA		
Non-intrinsically Safe Circuits (Signal Input)	Rated voltage: 24V DC Rated current: 5 mA (connector model: 4 mA)		

Note: Values in () are those approved by TIIS (Technology Institution of Industrial Safety, Japan).

General Specifications of Lamp Barrier

Power Voltage Type	AC Power	DC Power
Rated Power Voltage	100 to 240V AC (-15 to +10%)	24V DC (±10%)
Allowable Voltage Range	85 to 264V AC	21.6 to 26.4V DC
Rated Frequency	50/60 Hz (allowable range: 47 to 63 Hz)	—
Inrush Current	10A (100V AC) 20A (200V AC)	10A
Dielectric Strength (1 minute, 1 mA)	Between AC power and signal input: 1500V AC	
	Between intrinsically safe circuit and non-intrinsically safe circuit: 1526.4V AC (except for DC power and signal input)	
Operating Temperature	-20 to +60°C (no freezing)	
Storage Temperature	-20 to +60°C (no freezing)	
Operating Humidity	45 to 85% RH (no condensation)	
Atmosphere	800 to 1100 hPa	
Pollution Degree	2 (IEC60664)	
Insulation Resistance	10 MΩ minimum (500V DC megger, between the same poles as the dielectric strength)	
Vibration Resistance (damage limits)	Panel mounting: 10 to 55 Hz, amplitude 0.75 mm (2 hours each on X, Y, Z)	
	DIN rail mounting: 10 to 55 Hz, amplitude 0.35 mm (2 hours each on X, Y, Z)	
Shock Resistance (damage limits)	Panel mounting: 500 m/s ² (3 times each on X, Y, Z)	
	DIN rail mounting: 300 m/s ² (3 times each on X, Y, Z)	
Terminal Style	M3 screw terminal	
Mounting	35-mm-wide DIN rail or panel mounting (M4 screw)	
Power Consumption (approx.)	8.8 VA (EB3L-S10SAN at 200V AC) 5.2 W (EB3L-S16CSDN at 24V DC)	

General Specifications of Pilot Light, Illuminated Pushbutton, Illuminated Selector Switch, and Buzzer

Operating Temperature	-20 to +60°C (no freezing)	
Operating Humidity	45 to 85% RH (no condensation)	
Dielectric Strength (1 mA, 1 minute)	EB3P: 1000V AC IPL1: 500V AC (between intrinsically safe circuit and dead parts)	
Insulation Resistance	10 MΩ minimum (500V DC megger, between the same poles as the dielectric strength)	
Pilot Light and Miniature Pilot Light	Degree of Protection	IP65 (IEC60529) (except for terminals) EB3P-LU/IPL1: IP40
	Lens/Illumination Color	Pilot light: Amber, blue, green, red, white, yellow Miniature pilot light: Amber, green, red, white, yellow
Illuminated Switch	Degree of Protection	IP65 (IEC60529) (except for terminals) EB3P-LSAW** : IP54
	Illumination Color	Amber, blue, green, red, white, yellow
Buzzer	Contact Voltage/Current	12V DC ±10%, 10 mA ±20% (when connecting to the EB3C)
	Intrinsic Safety Ratings and Parameters	16-channel Common Wiring Maximum input voltage (Ui): 13.2V Maximum input current (Ii): 227.2 mA Maximum input power (Pi): 750 mW Internal capacitance (Ci): ≤ 32 nF Internal inductance (Li): ≤ 80 μH
	Weight	100g

Note: Connect buzzers in separate wiring. Buzzers cannot be used in common wiring.

Certification No.

Certification Organization	Explosion Protection	Certification No.
FM	Class I, II, III Div. 1 Group A, B, C, D, E, F, G	FM16US0364X
	Class I, Zone 0 AEx [ia] II C	
c-UL	Class I, II, III Div. 1 Group A, B, C, D, E, F, G	E234997 (except buzzer)
	Class I, Zone 0 [AEx ia] II C	
PTB (ATEX)	Lamp barrier: [Exia] II C	PTB09 ATEX2046 15 ATEX 6163X
	Buzzer: Exib II CT6	
PTB (IECEX)	Lamp barrier: [Exia] II C	IECEX PTB10.0015
CQC	Lamp barrier: [Exia Ga] II C	CNEEx 14.0047 CNEEx15.2108X
	Buzzer: Exib II CT6	
CQC (EX-CCC)	Lamp barrier: [Exia Ga] II C	2020012316310980 2020012309310993
	Buzzer: Exib II CT6 Ga	
KCs	Lamp barrier: [Exia] II C	14-AV4B0-0375 17-AV4B0-0355X
	Buzzer: Exib II CT6	
TIIS	Lamp barrier: [Exia] II C	TC20541
	Pilot light/Miniature pilot light (separate wiring) Exia II CT6	
	Pilot light/Miniature pilot light (common wiring) Exia II CT4	TC16360 TC16362 TC20797
	Illuminated switch: Exia II CT4 Buzzer: Exib II CT6	
NK	Lamp barrier: [Exia] II C	TA18437M TA17025M
	Buzzer: Exib II CT6	
KR	Lamp barrier: [Exia] II C	TYK17821-EL003 TYK17821-EL002
	Buzzer: Exib II CT6	

Note: Illuminated switches, pilot lights, and miniature pilot lights are certified by TIIS and NK only. Other certification organizations regard these units as simple apparatus, and require no certification. Buzzers are certified by TIIS only. Other ex-proof certifications pending.

Internal Circuit Block Diagram

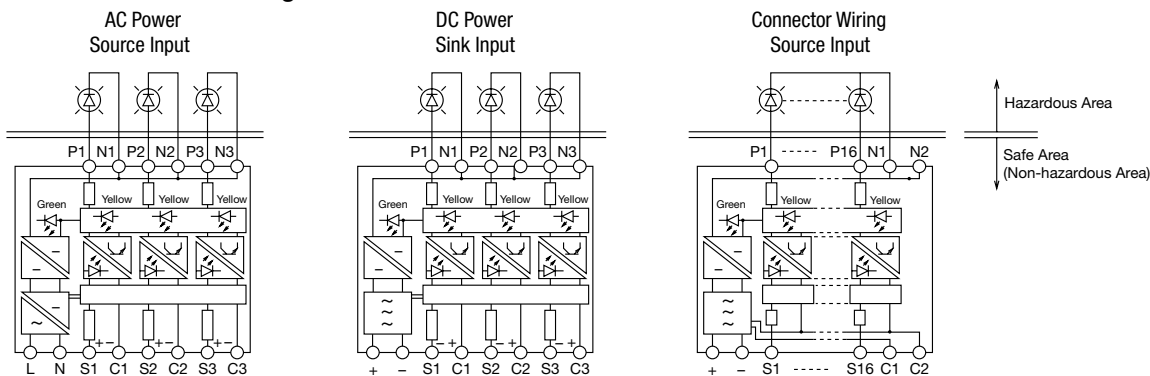

Dimensions

Terminal

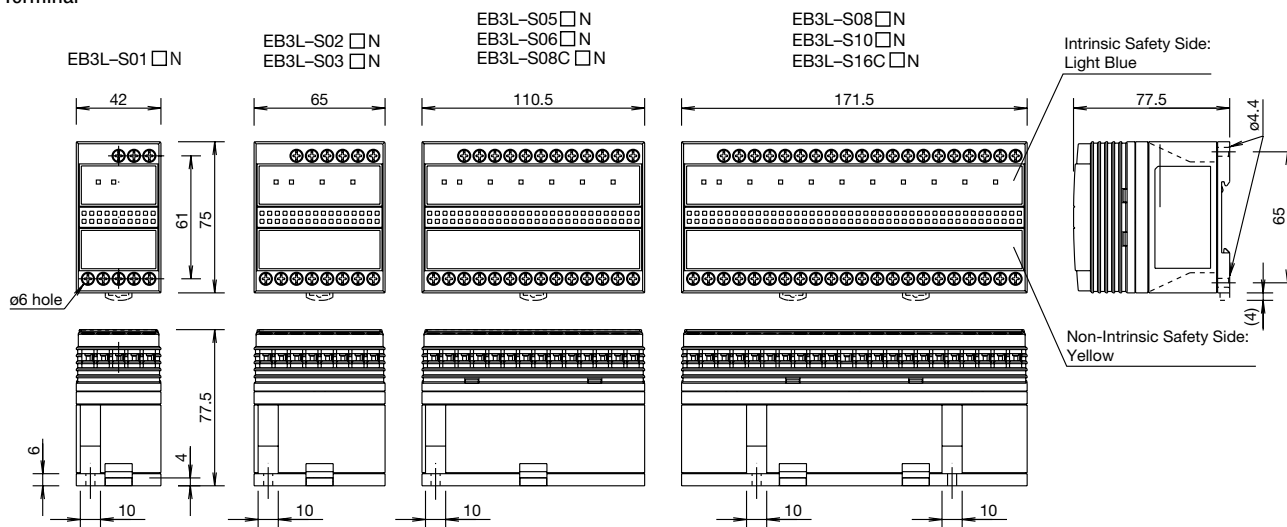

Mounting Hole Layout (Screw Mounting)

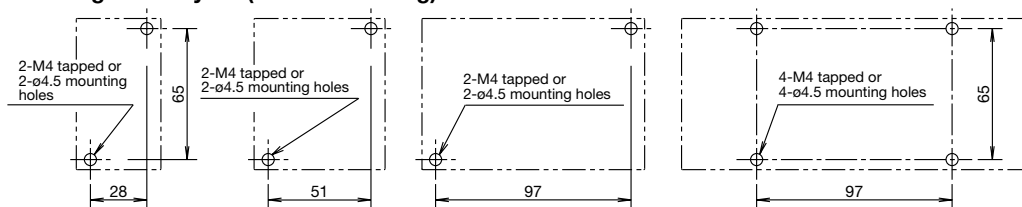

Connector

EB3L-S16C-CN

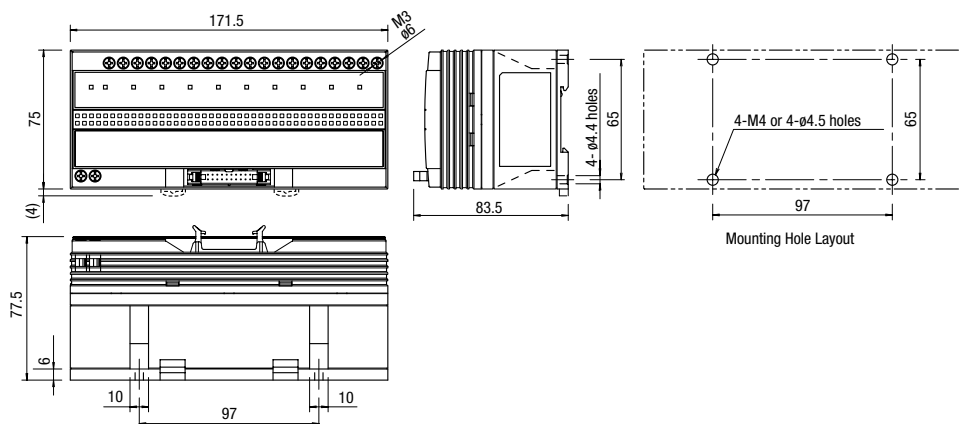

Applicable Crimping Terminal



Stripping the Wire End

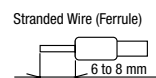
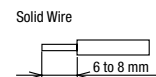

All dimensions in mm.

Pilot Lights

<p>ø30 EB3P-LAN1 Terminal Cover: APN-PVL (supplied)</p>	<p>ø30 EB3P-LUN4 Terminal Cover: APN-PVL (supplied)</p>	<p>ø30 EB3P-LAD Terminal Cover: APD-PVL (supplied)</p>	<p>ø30 EB3P-LUN3B Terminal Cover: APN-PVL (supplied)</p>
<p>ø22 EB3P-LAW1 Terminal Cover (supplied) APS-PVL Panel Thickness 1 to 6</p>	<p>ø22 EB3P-LAW1B Terminal Cover (supplied) APS-PVL Panel Thickness 1 to 6 Marking Plate: ø15.5</p>	<p>ø22 EB3P-LAW2 Terminal Cover (supplied) APS-PVL Panel Thickness 1 to 6</p>	<p>ø22 EB3P-LUW1B Terminal Cover (supplied) APS-PVL Panel Thickness 1 to 6 Marking Plate: □22</p>
<p>ø22 EB3P-LHW1/EB3P-LHW2/EB3P-LHW4 Terminal cover attached. Panel Thickness 0.8 to 6</p> <p>M3.5 Terminal Screw</p> <p>Gasket Locking Ring Flush Dome Round/Dome Square</p>		<p>ø22 EB3P-LLW1/EB3P-LLW2/EB3P-LLW3</p> <p>Gasket Locking Ring Panel Thickness 0.8 to 6</p> <p>Round Square Round w/square bezel</p>	

Miniature Pilot Lights (Terminal cover not available)

<p>ø10 IPL1-18</p>	<p>ø10 IPL1-19</p>	<p>ø8 IPL1-87</p>	<p>ø8 IPL1-88</p>
<p>ø8 IPL1-89</p>	<p>ø6 IPL1-67</p>	<p>ø6 IPL1-68</p>	<p>ø6 IPL1-69</p>

Illuminated Pushbuttons

<p>ø30 EB3P-LBAN211/LBAON211 Terminal cover: N-VL4 (2 pcs.) (sold separately)</p>	<p>ø30 EB3P-LBAVN311-R Terminal cover: N-VL4 (2 pcs.) (sold separately)</p>	
<p>ø22 EB3P-LBAW211/LBAOW211 Terminal cover attached.</p>	<p>ø22 EB3P-LBAW411-R Terminal cover attached.</p>	<p>ø22 EB3P-LBH1W110/LBHA1W110 Terminal cover attached.</p>
<p>ø22 EB3P-LBL1W1C2/LBLA1W1C2 Terminal cover: LW-VL2M (sold separately)</p>	<p>ø22 EB3P-LBL2W1C2/LBLA2W1C2 Terminal cover: LW-VL2M (sold separately)</p>	

All dimensions in mm.

Illuminated Selector Switches

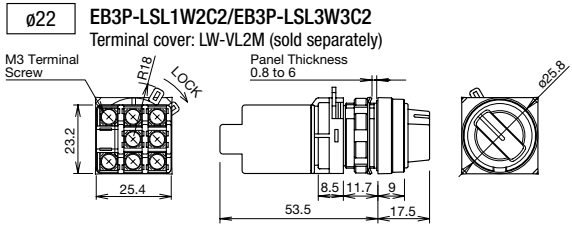
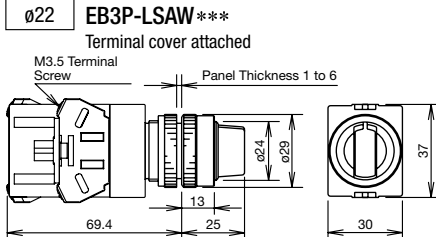
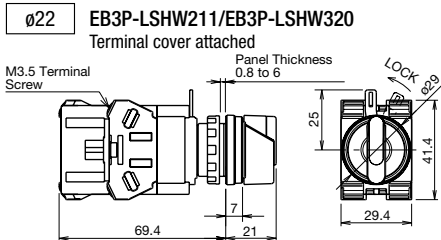
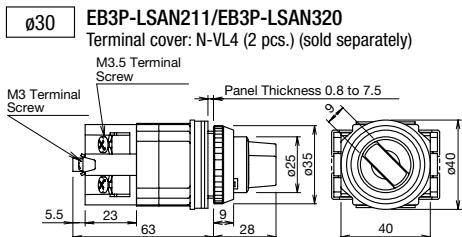

Buzzer

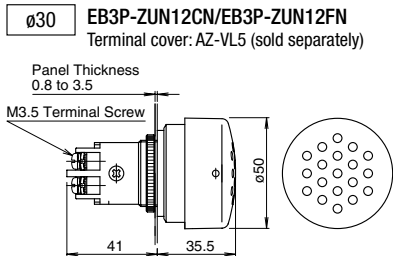

LED Lamp

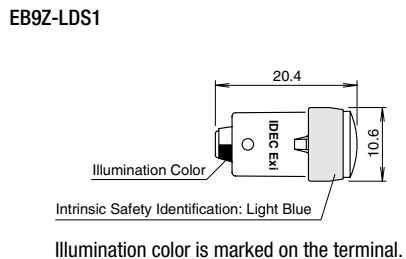

Polarity Identification

Pilot Lights/Illuminated Pushbuttons/Illuminated Selector Switches

- Positive terminal: X1
- Negative terminal: X2

Miniature Pilot Lights

- Positive terminal: Long pin terminal
- Negative terminal: Short pin terminal

Pin Terminals

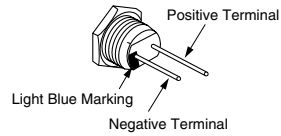

Buzzer

- Positive terminal: +
- Negative terminal: -

LED Lamp

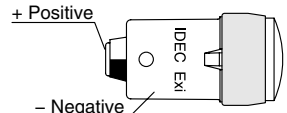

Panel Cut-out

Pilot Lights/Illuminated Pushbuttons/Illuminated Selector Switches/Buzzers

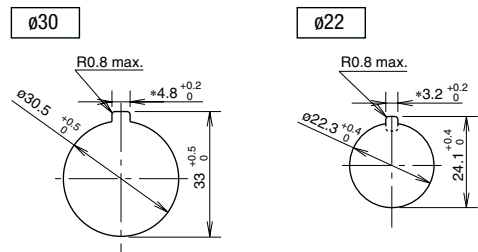

Miniature Pilot Lights

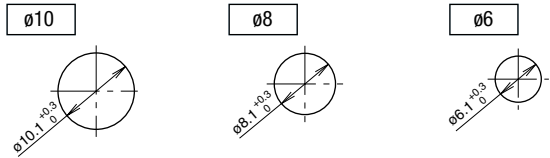

* The 4.8 or 3.2 recess is needed only when using an anti-rotation ring or a nameplate with an anti-rotation projection. EB3P-LHW does not have an anti-rotation groove.

Lamp Test

When checking the lamp lighting without using the EB3L lamp barrier, first make sure that the atmosphere is free from explosive gases. Connect a 12V DC power supply and a protection resistor of 1 kΩ in series to turn on the pilot light.

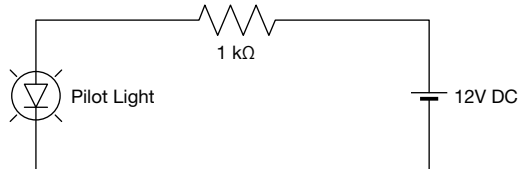

Non-intrinsically Safe External Input Wiring Examples

6-channel Source
(Ex.: EB3L-S06SAN)

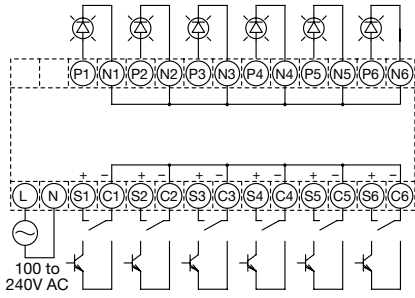

8-channel Common Wiring, Source
(Ex.: EB3L-S08CSDN)

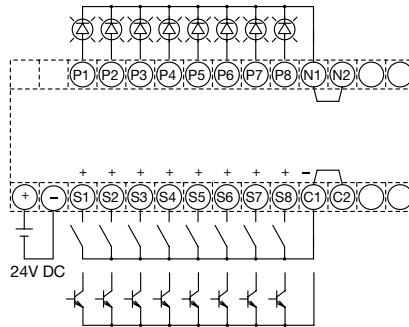

6-channel Sink
(Ex. EB3L-S06KAN)

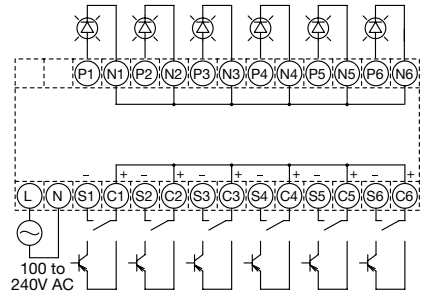

16-channel Common Wiring, Source
(Ex.: EB3L-S16CSDN)

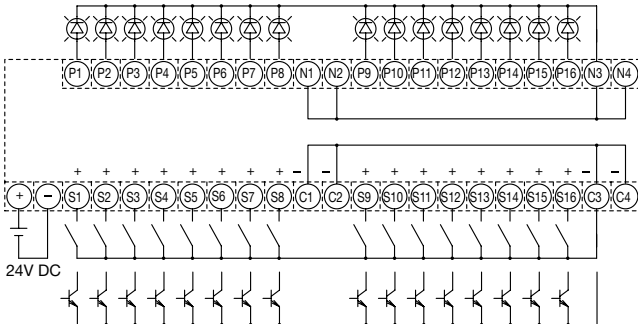

16-channel Common Wiring, Sink
(Ex.: EB3L-S16CKDN)

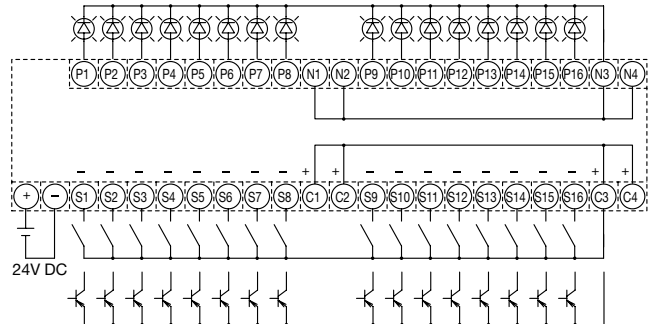

Note: Source input model can be connected to PLC sink output model
C terminal is the negative common line.

Note: Sink input model can be connected to PLC source output model
C terminal is the positive common line.

Connector Wiring Terminal Arrangement

EB3L-S16CSD-CN

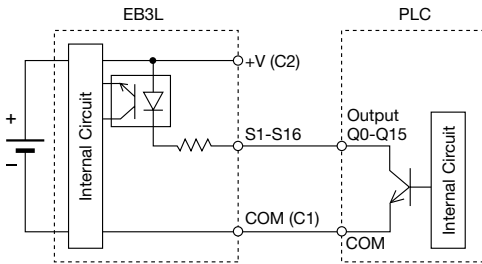
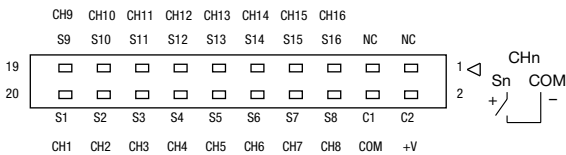

EB3L-S16CKD-CN

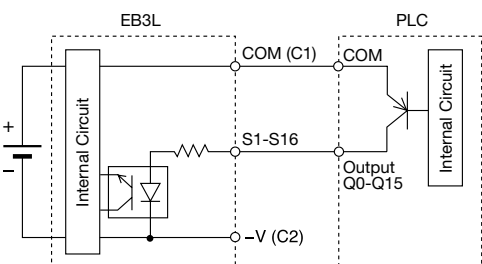
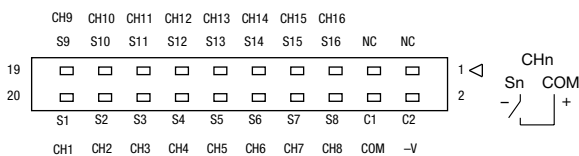

Wiring Example with IDEC's MicroSmart PLC Output Modules

FC6A-T16K3		EB3L-S16CSD-C		FC6A-T16P3		EB3L-S16CKD-C	
Terminal	Output	Input	Terminal	Terminal	Output	Input	Terminal
20	Q0	S1	20	20	Q0	S1	20
19	Q10	S9	19	19	Q10	S9	19
18	Q1	S2	18	18	Q1	S2	18
17	Q11	S10	17	17	Q11	S10	17
16	Q2	S3	16	16	Q2	S3	16
15	Q12	S11	15	15	Q12	S11	15
14	Q3	S4	14	14	Q3	S4	14
13	Q13	S12	13	13	Q13	S12	13
12	Q4	S5	12	12	Q4	S5	12
11	Q14	S13	11	11	Q14	S13	11
10	Q5	S6	10	10	Q5	S6	10
9	Q15	S14	9	9	Q15	S14	9
8	Q6	S7	8	8	Q6	S7	8
7	Q16	S15	7	7	Q16	S15	7
6	Q7	S8	6	6	Q7	S8	6
5	Q17	S16	5	5	Q17	S16	5
4	COM (-)	COM	4	4	COM (+)	COM	4
3	COM (-)	NC	3	3	COM (+)	NC	3
2	+V	+V	2	2	-V	-V	2
1	+V	NC	1	1	-V	NC	1

Note: The wiring in dashed line does not affect the operation of the EB3L.
Applicable connector is IDEC's JE1S-201.
Output power for PLC outputs is supplied by the EB3L, therefore the PLC output does not need an external power supply.

Wiring Example of Intrinsically Safe External Outputs

1. Common Wiring (Maximum 16 circuits) (Buzzers cannot be wired in a common line.)

All output lines are wired to a common line inside the intrinsically safe equipment (one common line per intrinsically safe circuit).

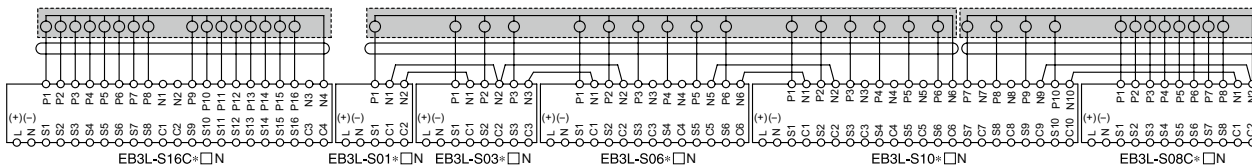

All input lines are wired to a common line outside the intrinsically safe equipment (one common line per intrinsically safe circuit).

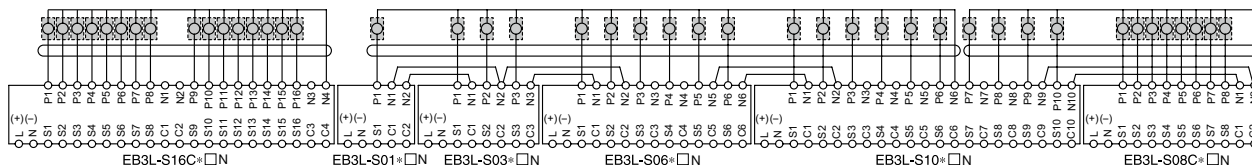

2. Separate Wiring

Each output line of the EB3L makes up one independent intrinsically safe circuit of a pilot light or buzzer.

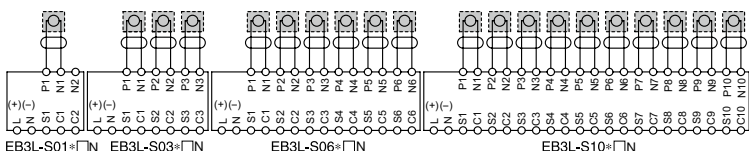

Note:
When using two or more EB3L's to set up one intrinsically safe circuit in the common wiring configuration, interconnect two neutral terminals (N1 through N10) on each EB3L between adjacent EB3L's in parallel.

3. Wiring Illuminated Pushbuttons and Illuminated Selector Switches

(A maximum of 16 channels of EB3L and EB3C can be wired to a common line.)

The following example illustrates the wiring for a total of 10 contacts used by three illuminated pushbuttons (LB1 to LB3) and three illuminated selector switches (LS1 to LS3).

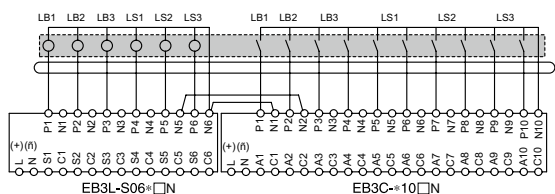
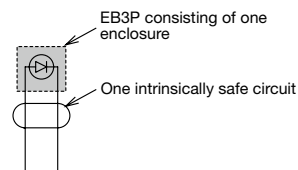

Diagram Symbols



One intrinsically safe circuit is a connection consisting of one or more illuminated units connected to a common line.

Recommended Connector Cable for Connector Models

Description		No. of Poles	Length (m)	Part No.	Shape	Applicable Model
I/O Terminal Cable	With Shield	20	0.5	FC9Z-H050A20		IDEC MicroSmart I/O Module
			1	FC9Z-H100A20		
			2	FC9Z-H200A20		
	Without Shield		0.5	FC9Z-H050B20		IDEC MicroSmart I/O Module
			1	FC9Z-H100B20		
			2	FC9Z-H200B20		
Cable with Crimping Terminal			1	BX9Z-H100E4		Screw Terminal
			2	BX9Z-H200E4		
			3	BX9Z-H300E4		
40-pin Cable for PLC			1	BX9Z-H100B		Mitsubishi A Series Output Module (sink) ↓ EB3L-S16CSD-CN
			2	BX9Z-H200B		
			3	BX9Z-H300B		

BX9Z-H□□□B Internal Connection

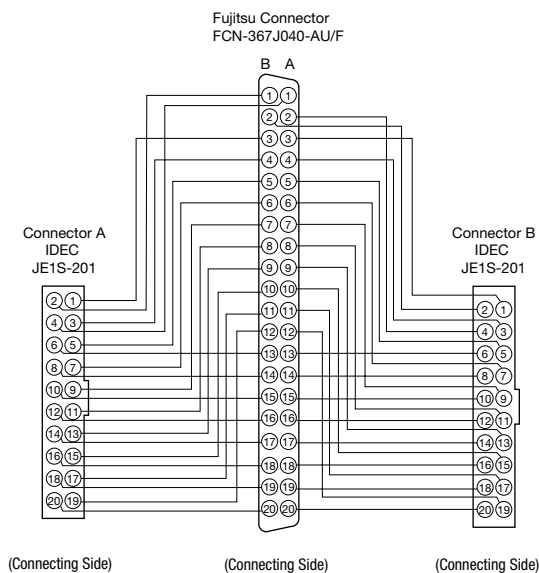

FC9Z-H□□□E Internal Connection

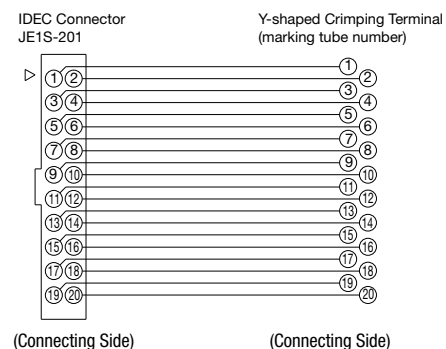

(Straight wire connection BX9Z-H□□□B: number of cable with crimping terminal)

FC9Z-H□□□A, FC9Z-H□□□B Internal Connection

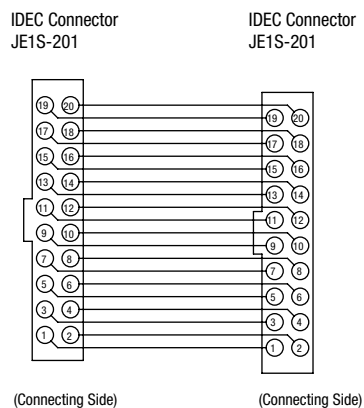

Operating Instructions

1. Installation of EB3L Lamp Barriers

- (1) The EB3L can be installed in any direction.
- (2) Install the EB3L lamp barrier in a safe area (non-hazardous area) in accordance with intrinsic safety ratings and parameters. To avoid mechanical shocks, install the EB3L in an enclosure which suppresses shocks.
- (3) When installing or wiring the EB3L, prevent electromagnetic and electrostatic inductions in the intrinsically safe circuit. Also prevent the intrinsically safe circuits from contacting with another intrinsically safe circuit and any other circuits.
Maintain at least 50 mm clearance, or provide a metallic separating board between the intrinsically safe circuit and non-intrinsically safe circuit. When providing a metallic separating board, make sure that the board fits closely to the enclosure (top, bottom, and both sides). Allowable clearance between the enclosure and board is 1.5 mm at the maximum.
The clearance of 50 mm between the intrinsically safe circuit and non-intrinsically safe circuit may not be sufficient when a motor circuit or high-voltage circuit is installed nearby. In this case, provide a wider clearance between the circuits referring to 6. (3) "Minimum Parallel Distance between the Intrinsically Safe Circuit and Other Circuits."
- (4) In order to prevent contact between intrinsically safe circuits and non-intrinsically safe circuits, mount EB3L units with terminals arranged in the same direction.

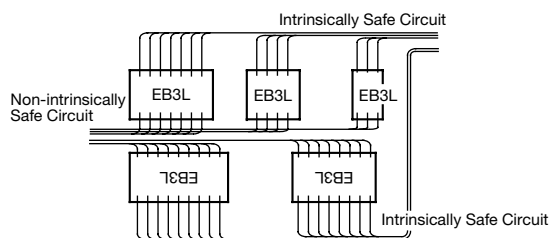

- (5) Maintain at least 6 mm (or 3 mm according to IEC60079-11: 1999) clearance between the terminal of intrinsically safe circuit and the grounded metal part of a metal enclosure, and between the relay terminal block of an intrinsically safe circuit and the grounded metal part of a metal enclosure.
- (6) For installing the EB3L, mount on a 35-mm-wide DIN rail or directly on a panel using screws. The EB3L can be installed in any direction. Make sure to install securely to withstand vibration. When mounting on a DIN rail, push in the clamp completely. Use the BNL6 end clips on both sides of the EB3L to prevent from moving sideways.
- (7) Excessive extraneous noise may cause malfunction and damage to the EB3L. When extraneous noise activates the voltage limiting circuit (thyristor), remove the noise source and restore the power.

2. Terminal Wiring

- (1) Using a $\phi 5.5$ mm or smaller screw driver, tighten the terminal screws (including unused terminal screws) to a torque of 0.6 to 1.0 N·m (recommended value).
- (2) Make sure that IP20 is achieved when wiring. Use insulation tubes on bare crimping terminals.
- (3) To prevent disengaged wires from contacting with other intrinsically safe circuits, bind together the wires of one intrinsically safe circuit.
- (4) When the adjacent terminal is connected to another intrinsically safe circuit, provide an insulation distance of at least 6 mm.

3. Signal Input

- (1) Connect the EB3L to the switches or output equipment which have a low leakage current (0.1 mA maximum).
- (2) The EB3L is equipped with power supply. Do not apply external power to the EB3L.
- (3) When connecting the EB3L's of connector model in parallel, make sure that the same power supply is used. When using C1 and C2 terminals to supply power to outside equipment, maintain the current at 50 mA maximum.

4. Power Voltage

- (1) Do not apply an excessive power voltage, otherwise the EB3L may be damaged.
- (2) The EB3L of AC power type may operate at a low voltage (approx. 20V).

5. Pilot Lights, Illuminated Switches, and Buzzers in the Hazardous Area

- (1) EB3P and IPL1 units shown on page 3 can be used with the EB3L. Buzzers cannot be connected in common wiring.
- (2) Install the EB3P and IPL1 units on enclosures of IP20 or higher protection. Use a metallic enclosure with magnesium content of 7.5% or less (steel and aluminum are acceptable).
- (3) When wiring, make sure of correct polarities of the EB3P and IPL1.
- (4) Certification mark is supplied with the units. Attach it on the visible area of the EB3P or IPL1 (for Japan application).
- (5) When connecting illuminated switches to the EB3L lamp barrier and the EB3C relay barrier, a maximum of 16 channels can be connected in common wiring.

Operating Instructions

6. Wiring for Intrinsic Safety

- (1) The voltage applied on the general circuit connected to the non-intrinsically safe circuit terminals of the EB3L lamp barrier must be 250V AC, 50/60Hz, or 250V DC at the maximum under any conditions, including the voltage of the power line and the internal circuit.
- (2) When wiring, take into consideration the prevention of electromagnetic and electrostatic charges on intrinsically safe circuits. Also, prevent intrinsically safe circuits from contacting with other circuits.
- (3) The intrinsically safe circuits must be separated from non-intrinsically safe circuits. Contain intrinsically safe circuits in a metallic tube or duct, or separate the intrinsically safe circuits referring to the table at right.

Note: Cables with a magnetic shield, such as a metallic sheath, prevent electromagnetic induction and electrostatic induction, however, a non-magnetic shield prevents electrostatic induction only. For non-magnetic shields, take a preventive measure against electromagnetic induction.

Finely twisted pair cables prevent electromagnetic induction. Adding shields to the twisted pair cables provides protection against electrostatic induction.

Minimum Parallel Distance between the Intrinsically Safe Circuit and Other Circuits (mm)

Voltage and Current of Other Circuits	Over 100A	100A or less	50A or less	10A or less
Over 440V	2000	2000	2000	2000
440V or less	2000	600	600	600
220V or less	2000	600	600	500
110V or less	2000	600	500	300
60V or less	2000	500	300	150

- (4) When identifying intrinsically safe circuits by color, use light blue terminal blocks and cables.
- (5) When using two or more EB3L's to set up one intrinsically safe circuit in the common wiring configuration, interconnect two neutral terminals (N1 through N10) on each EB3L between adjacent EB3L's in parallel.
- (6) Make sure that the power of the EB3L, pilot lights, and other connected units are turned off before starting inspection or replacement.

- (7) When wiring the intrinsically safe circuit, determine the distance to satisfy the wiring parameters shown below. Note that parameters are different between separate wiring and common wiring and depend on the connected units, such as pilot lights, illuminated pushbuttons, and buzzers.

- a) Wiring capacitance $C_w \leq C_o - C_i$
 C_o : Maximum external capacitance of the EB3L
 C_i : Internal capacitance of the connected unit
- b) Wiring inductance $L_w \leq L_o - L_i$
 L_o : Maximum external inductance of the EB3L
 L_i : Internal inductance of the connected unit
- c) Wiring resistance $\leq R_w$
 R_w : Allowable wiring resistance
- d) Allowable wiring distance D (km) is the smallest value of those calculated from the capacitance, inductance, and resistance.
 $D \leq C_w/C$ C (nF/km): Capacitance of cable per km
 $D \leq L_w/L$ L (mH/km): Inductance of cable per km
 $D \leq R_w/2R$ R (Ω /km): Resistance of cable per km

Note: For the details of wiring the intrinsically safe circuits, refer to a relevant test guideline for explosion-proof electric equipment in each country.

Safety Precautions

- Do not use the EB3C Relay Barrier and EB3L Lamp Barrier for other than explosion protection purposes.
- Read the user's manual to make sure of correct operation before starting installation, wiring, operation, maintenance, and inspection of the EB3C Relay Barrier and EB3L Lamp Barrier.

Ordering Terms and Conditions

Thank you for using IDEC Products.

By purchasing products listed in our catalogs, datasheets, and the like (hereinafter referred to as "Catalogs") you agree to be bound by these terms and conditions. Please read and agree to the terms and conditions before placing your order.

1. Notes on contents of Catalogs

- (1) Rated values, performance values, and specification values of IDEC products listed in this Catalog are values acquired under respective conditions in independent testing, and do not guarantee values gained in combined conditions.
Also, durability varies depending on the usage environment and usage conditions.
- (2) Reference data and reference values listed in Catalogs are for reference purposes only, and do not guarantee that the product will always operate appropriately in that range.
- (3) The specifications / appearance and accessories of IDEC products listed in Catalogs are subject to change or termination of sales without notice, for improvement or other reasons.
- (4) The content of Catalogs is subject to change without notice.

2. Note on applications

- (1) If using IDEC products in combination with other products, confirm the applicable laws / regulations and standards.
Also, confirm that IDEC products are compatible with your systems, machines, devices, and the like by using under the actual conditions. IDEC shall bear no liability whatsoever regarding the compatibility with IDEC products.
- (2) The usage examples and application examples listed in Catalogs are for reference purposes only. Therefore, when introducing a product, confirm the performance and safety of the instruments, devices, and the like before use. Furthermore, regarding these examples, IDEC does not grant license to use IDEC products to you, and IDEC offers no warranties regarding the ownership of intellectual property rights or non-infringement upon the intellectual property rights of third parties.
- (3) When using IDEC products, be cautious when implementing the following.
 - i. Use of IDEC products with sufficient allowance for rating and performance
 - ii. Safety design, including redundant design and malfunction prevention design that prevents other danger and damage even in the event that an IDEC product fails
 - iii. Wiring and installation that ensures the IDEC product used in your system, machine, device, or the like can perform and function according to its specifications
- (4) Continuing to use an IDEC product even after the performance has deteriorated can result in abnormal heat, smoke, fires, and the like due to insulation deterioration or the like. Perform periodic maintenance for IDEC products and the systems, machines, devices, and the like in which they are used.
- (5) IDEC products are developed and manufactured as general-purpose products for general industrial products. They are not intended for use in the following applications, and in the event that you use an IDEC product for these applications, unless otherwise agreed upon between you and IDEC, IDEC shall provide no guarantees whatsoever regarding IDEC products.
 - i. Use in applications that require a high degree of safety, including nuclear power control equipment, transportation equipment (railroads / airplanes / ships / vehicles / vehicle instruments, etc.), equipment for use in outer space, elevating equipment, medical instruments, safety devices, or any other equipment, instruments, or the like that could endanger life or human health
 - ii. Use in applications that require a high degree of reliability, such as provision systems for gas / waterworks / electricity, etc., systems that operate continuously for 24 hours, and settlement systems
 - iii. Use in applications where the product may be handled or used deviating from the specifications or conditions / environment listed in the Catalogs, such as equipment used outdoors or applications in environments subject to chemical pollution or electromagnetic interference
If you would like to use IDEC products in the above applications, be sure to consult with an IDEC sales representative.

3. Inspections

We ask that you implement inspections for IDEC products you purchase without delay, as well as thoroughly keep in mind management/maintenance regarding handling of the product before and during the inspection.

4. Warranty

- (1) Warranty period
The warranty period for IDEC products shall be one (1) year after purchase or delivery to the specified location. However, this shall not apply in cases where there is a different specification in the Catalogs or there is another agreement in place between you and IDEC.
- (2) Warranty scope
Should a failure occur in an IDEC product during the above warranty period for reasons attributable to IDEC, then IDEC shall replace or repair that product, free of charge, at the purchase location / delivery location of the product, or an IDEC service base. However, failures caused by the following reasons shall be deemed outside the scope of this warranty.
 - i. The product was handled or used deviating from the conditions / environment listed in the Catalogs
 - ii. The failure was caused by reasons other than an IDEC product
 - iii. Modification or repair was performed by a party other than IDEC
 - iv. The failure was caused by a software program of a party other than IDEC
 - v. The product was used outside of its original purpose
 - vi. Replacement of maintenance parts, installation of accessories, or the like was not performed properly in accordance with the user's manual and Catalogs
 - vii. The failure could not have been predicted with the scientific and technical standards at the time when the product was shipped from IDEC
 - viii. The failure was due to other causes not attributable to IDEC (including cases of force majeure such as natural disasters and other disasters)Furthermore, the warranty described here refers to a warranty on the IDEC product as a unit, and damages induced by the failure of an IDEC product are excluded from this warranty.

5. Limitation of liability

The warranty listed in this Agreement is the full and complete warranty for IDEC products, and IDEC shall bear no liability whatsoever regarding special damages, indirect damages, incidental damages, or passive damages that occurred due to an IDEC product.

6. Service scope

The prices of IDEC products do not include the cost of services, such as dispatching technicians. Therefore, separate fees are required in the following cases.

- (1) Instructions for installation / adjustment and accompaniment at test operation (including creating application software and testing operation, etc.)
- (2) Maintenance inspections, adjustments, and repairs
- (3) Technical instructions and technical training
- (4) Product tests or inspections specified by you

The above content assumes transactions and usage within your region. Please consult with an IDEC sales representative regarding transactions and usage outside of your region. Also, IDEC provides no guarantees whatsoever regarding IDEC products sold outside your region.

IDEC CORPORATION

Head Office 6-64, Nishi-Miyahara-2-Chome, Yodogawa-ku, Osaka 532-0004, Japan

 www.idec.com

USA IDEC Corporation
EMEA APEM SAS

Singapore IDEC Izumi Asia Pte. Ltd.
Thailand IDEC Asia (Thailand) Co., Ltd.
India IDEC Controls India Private Ltd.

China IDEC (Shanghai) Corporation
IDEC Izumi (H.K.) Co., Ltd.
Taiwan IDEC Taiwan Corporation

Japan IDEC Corporation

Specifications and other descriptions in this brochure are subject to change without notice.

2022 IDEC Corporation, All Rights Reserved.

